

# POLYSWITCH RESETTABLE DEVICES

## Automotive Devices

We have provided PPTC resettable devices for the automotive industry for over 25 years. With the advent of TS16949 and our continued involvement in the automotive industry, Littelfuse PolySwitch team developed automotive-specific versions of PPTC devices (femtoASMD, picoASMD, nanoASMD, microASMD, miniASMD, ASMD, AHS, ASMD, AHRF, AHEF and AGRF). These products are qualified and sold under the PS400 specification which is derived from AEC-Q200, the standard for electronic components used in the automotive industry. The key difference between these product families and other protection devices in our circuit protection product portfolio is the qualification process that is followed that includes a series of rigorous tests related to the automotive environment. As a result, they are characterized by specific additional values determined following automotive-related testing.



### BENEFITS

- Expertise from the world's leading resettable overcurrent protection manufacturer
- High-quality products from the world's largest passive component manufacturer
- Worldwide team dedicated to support automotive applications
- Wide range of dedicated automotive surface-mount and radial-leaded resettable overcurrent devices
- High-performance transient voltage protection devices

### FEATURES

- RoHS compliant
- Overcurrent and overvoltage circuit protection devices
- Resettable and single-use overcurrent devices
- Wide range of form factor and termination methods
- Products meet applicable automotive industry standards
- Devices compatible with high-volume electronics assembly

### APPLICATIONS

- Motor and motor circuit protection including power door-locks, mirrors, lumbar pumps, seats, sunroofs and windows
- Electronic Control Unit (ECU) I/O protection
- Heating, Ventilation and Cooling (HVAC) motor and I/O protection
- Telematics, infotainment and navigations systems
- Liquid Crystal Display (LCD) back-light heaters
- Power and cigarette lighter outlets, plugs and adapter/chargers
- Powered networks and buses
- Air-flow detection and overcurrent protection in HVAC and cooling fan systems
- Stall detection in express window and sunroof circuits
- Resettable overcurrent protection for power distribution, electrical centers and junction boxes
- Wire downsizing
- Motor electromagnetic interference (EMI) suppression
- Electrostatic discharge (ESD) damage protection
- Load dump and other transient voltage protection

# PolySwitch Resettable Devices

## Automotive Devices

Table A1 — Product Series - Current Rating, Voltage Rating/Typical Resistance

Voltage Rating	AGRF 16V	AHRF 16V	AHRF 30V	AHEF 32V	AHS 16V	ASMD 16V	ASMD 30V	ASMD 33V	ASMD 60V
<b>Hold Current (A)</b>									
0.30	—	—	—	—	—	—	—	—	2.90Ω
0.50	—	—	0.565Ω	0.5650Ω	—	—	—	—	0.90Ω
0.70	—	—	0.385Ω	0.3850Ω	—	—	—	—	—
0.75	—	—	—	—	—	—	0.60Ω	—	—
0.80	—	—	—	—	0.250Ω	—	—	—	—
1.00	—	—	0.225Ω	0.2250Ω	—	—	0.30Ω	—	—
1.20	—	—	—	—	0.245Ω	—	—	—	—
1.25	—	—	—	—	—	0.160Ω	—	—	—
1.50	—	—	—	—	—	0.140Ω	—	0.149Ω	—
1.60	—	—	—	—	0.100Ω	—	—	—	—
1.85	—	—	—	—	—	0.079Ω	—	—	—
2.00	—	0.0565Ω	—	—	0.070Ω	0.090Ω	—	—	—
2.50	—	—	—	—	—	0.060Ω	—	—	—
3.00	—	0.0410Ω	—	0.0520Ω	0.050Ω	—	—	—	—
4.00	0.0300Ω	0.0305Ω	—	—	—	—	—	—	—
4.50	—	0.0290Ω	—	—	—	—	—	—	—
5.00	0.0192Ω	—	—	0.0200Ω	—	—	—	—	—
5.50	—	0.0190Ω	—	—	—	—	—	—	—
6.00	0.0145Ω	0.0180Ω	—	—	—	—	—	—	—
6.50	—	0.0140Ω	—	—	—	—	—	—	—
7.00	0.0105Ω	0.0126Ω	—	—	—	—	—	—	—
7.50	—	0.0120Ω	—	0.0120Ω	—	—	—	—	—
8.00	0.0086Ω	0.0104Ω	—	—	—	—	—	—	—
9.00	0.0070Ω	0.0100Ω	—	—	—	—	—	—	—
10.00	0.0056Ω	0.0083Ω	—	0.0083Ω	—	—	—	—	—
11.00	0.0050Ω	0.0069Ω	—	—	—	—	—	—	—
12.00	0.0046Ω	—	—	—	—	—	—	—	—
13.00	—	0.0055Ω	—	—	—	—	—	—	—
14.00	0.0040Ω	0.0050Ω	—	—	—	—	—	—	—
15.00	—	0.0050Ω	—	—	—	—	—	—	—

# PolySwitch Resettable Devices

## Automotive Devices

Table A1 – Product Series - Current Rating, Voltage Rating/Typical Resistance (Cont'd)

Voltage Rating	femtoASMDC 15V	femtoASMDC 12V	picoASMDC 15V	nanoASMDC 60V	nanoASMDC 48V	nanoASMDC 24V	nanoASMDC 16V	nanoASMDC 13.2V	microASMD 30V	microASMD 13.2V
<b>Hold Current (A)</b>										
0.05	16.90Ω	—	—	—	—	—	—	—	26.80Ω	—
0.08	—	8.40Ω	—	—	—	—	—	—	—	—
0.10	8.00Ω	—	6.25Ω	8.30Ω	—	—	—	—	8.55Ω	—
0.12	—	—	5.25Ω	—	3.95Ω	—	—	—	—	—
0.16	—	—	—	—	3.05Ω	—	—	—	—	—
0.20	—	—	—	—	—	1.875Ω	—	—	—	—
0.25	—	—	—	—	—	—	1.25Ω	—	—	—
0.35	—	—	—	—	—	—	0.90Ω	—	—	—
0.50	—	—	—	—	—	—	—	0.475Ω	—	0.575Ω

Voltage Rating	miniASMDC 60V	miniASMDC 33V	miniASMDC 30V	miniASMDC 24V	miniASMDC 16V	miniASMDC 13.2V	miniASMDC 12V	ASMDC 60V	ASMDC 33V	ASMDC 24V
<b>Hold Current (A)</b>										
0.10	6.70Ω	—	—	—	—	—	—	—	—	—
0.14	3.75Ω	—	—	—	—	—	—	—	—	—
0.20	—	—	1.950Ω	—	—	—	—	—	—	—
0.30	—	—	0.975Ω	—	—	—	—	1.850Ω	—	—
0.50	—	—	—	0.575Ω	—	—	—	0.675Ω	—	—
0.75	—	0.25Ω	—	0.190Ω	—	0.280Ω	—	—	0.355Ω	—
1.10	—	—	—	0.120Ω	0.1200Ω	—	—	—	—	—
1.25	—	—	—	—	0.0950Ω	—	—	—	0.145Ω	—
1.50	—	—	—	0.080Ω	0.0750Ω	—	0.075Ω	—	—	—
1.85	—	—	—	—	—	—	—	—	0.100Ω	—
2.00	—	—	—	—	0.0525Ω	—	—	—	—	—
2.60	—	—	—	—	0.0325Ω	0.0325Ω	0.031Ω	—	—	—
3.00	—	—	—	—	—	—	—	—	—	0.0435Ω

# PolySwitch Resettable Devices

## Automotive Devices

Table A2 – Thermal Derating [Hold Current (A) at Ambient Temperature (°C)]

Part Number	Maximum Ambient Temperature										
	-40°C	-20°C	0°C	20°C	25°C	40°C	50°C	60°C	70°C	85°C	125°C
<b>AGRF</b>											
<b>16V – Radial-leaded</b>											
AGRF400	5.9	5.3	4.8	4.1	4.0	3.5	3.2	2.8	2.5	1.9	—
AGRF500	7.3	6.6	6.0	5.2	5.0	4.4	4.0	3.6	3.1	2.4	—
AGRF600	8.8	8.0	7.2	6.2	6.0	5.2	4.8	4.2	3.8	2.8	—
AGRF700	10.3	9.3	8.4	7.3	7.0	6.2	5.6	5.0	4.4	3.3	—
AGRF800	11.7	10.7	9.6	8.3	8.0	6.9	6.4	5.6	5.1	3.7	—
AGRF900	13.2	11.9	10.7	9.4	9.0	7.9	7.2	6.4	5.6	4.2	—
AGRF1000	14.7	13.3	12.0	10.3	10.0	8.7	8.0	7.0	6.3	4.7	—
AGRF1100	16.1	14.6	13.1	11.5	11.0	9.7	8.8	7.8	6.9	5.2	—
AGRF1200	17.6	16.0	14.4	12.4	12.0	10.4	9.6	8.4	7.6	5.6	—
AGRF1400	20.5	18.7	16.8	14.5	14.0	12.1	11.2	9.8	8.9	6.5	—
<b>AHRF (High Temperature)</b>											
<b>30V – Radial-leaded</b>											
AHRF050	0.7	0.6	0.6	0.5	0.5	0.4	0.4	0.4	0.3	0.3	0.1
AHRF070	1.0	0.9	0.8	0.7	0.7	0.6	0.6	0.5	0.5	0.4	0.2
AHRF100	1.4	1.2	1.1	1.0	1.0	0.9	0.8	0.7	0.7	0.6	0.2
<b>AHRF (High Temperature)</b>											
<b>16V – Radial-leaded</b>											
AHRF200	2.7	2.5	2.3	2.1	2.0	1.8	1.6	1.5	1.3	1.1	0.5
AHRF300	4.1	3.7	3.4	3.1	3.0	2.7	2.4	2.2	2.0	1.7	0.7
AHRF400	5.6	5.1	4.7	4.2	4.0	3.6	3.3	3.0	2.7	2.3	1.0
AHRF450	6.1	5.6	5.1	4.6	4.5	4.0	3.6	3.3	3.0	2.5	1.1
AHRF550	7.5	6.9	6.2	5.7	5.5	4.9	4.4	4.0	3.7	3.1	1.4
AHRF600	8.2	7.5	6.8	6.2	6.0	5.3	4.9	4.4	4.0	3.3	1.5
AHRF650	8.8	8.1	7.4	6.7	6.5	5.7	5.3	4.8	4.3	3.6	1.6
AHRF700	9.5	8.7	8.0	7.2	7.0	6.2	5.6	5.2	4.7	3.9	1.7
AHRF750	10.2	9.4	8.6	7.7	7.5	6.6	6.1	5.6	5.0	4.1	1.9
AHRF800	10.9	10.0	9.1	8.2	8.0	7.1	6.4	5.9	5.3	4.4	2.0
AHRF900	12.2	11.2	10.2	9.3	9.0	8.0	7.2	6.6	6.0	5.0	2.2
AHRF1000	13.6	12.5	11.4	10.3	10.0	8.8	8.1	7.4	6.6	5.5	2.5
AHRF1100	14.9	13.7	12.5	11.3	11.0	9.7	8.8	8.1	7.3	6.1	2.7
AHRF1300	17.7	16.3	14.8	13.4	13.0	11.4	10.5	9.6	8.6	7.2	3.3
AHRF1400	19.0	17.5	15.9	14.4	14.0	12.4	11.2	10.3	9.3	7.8	3.5
AHRF1500	20.4	18.8	17.1	15.5	15.0	13.2	12.1	11.1	9.9	8.3	3.8
<b>AHEF (High Temperature)</b>											
<b>32V – Radial-leaded</b>											
AHEF050	0.7	0.6	0.60	0.5	0.5	0.4	0.400	0.40	0.30	0.300	0.1
AHEF070	1.0	0.9	0.80	0.7	0.7	0.6	0.600	0.50	0.50	0.400	0.2
AHEF100	1.4	1.2	1.10	1.0	1.0	0.9	0.800	0.70	0.70	0.600	0.2
AHEF300	4.1	3.8	3.42	3.1	3.0	2.7	2.430	2.22	1.98	1.650	0.6
AHEF500	6.8	6.3	5.70	5.2	5.0	4.5	4.050	3.70	3.30	2.750	1.0
AHEF750	10.2	9.4	8.55	7.7	7.5	6.7	6.075	5.55	4.95	4.125	1.5
AHEF1000	13.6	12.5	11.40	10.3	10.0	8.9	8.100	7.40	6.60	5.500	2.0
<b>AHS (High Temperature)</b>											
<b>16V – Surface-mount</b>											
AHS080-2018	1.20	1.04	0.90	0.8	0.77	0.68	0.62	0.60	0.53	0.46	0.26
AHS120	1.72	1.54	1.36	1.2	1.14	1.01	0.92	0.83	0.74	0.61	0.25
AHS160	2.15	1.96	1.78	1.6	1.55	1.42	1.33	1.24	1.15	1.01	0.64
AHS200	2.90	2.50	2.20	2.0	1.94	1.80	1.75	1.70	1.40	1.18	0.67
AHS300	4.20	3.80	3.70	3.0	2.92	2.63	2.44	2.10	2.00	1.76	1.00

# PolySwitch Resettable Devices

## Automotive Devices

Table A2 – Thermal Derating [Hold Current (A) at Ambient Temperature (°C)] (Cont'd)

Part Number	Maximum Ambient Temperature										
	-40°C	-20°C	0°C	20°C	25°C	40°C	50°C	60°C	70°C	85°C	125°C
<b>ASMD</b>											
<b>16-60V – Surface-mount</b>											
ASMD030F	0.35	0.31	0.27	0.23	0.22	0.19	0.17	0.15	0.13	0.11	—
ASMD050F	0.59	0.53	0.46	0.39	0.37	0.33	0.29	0.26	0.23	0.18	—
ASMD075F	0.91	0.81	0.71	0.60	0.58	0.50	0.45	0.40	0.35	0.28	—
ASMD100F	1.37	1.22	1.06	0.90	0.86	0.76	0.68	0.60	0.52	0.41	—
ASMD125F	1.58	1.40	1.23	1.04	1.00	0.87	0.78	0.70	0.60	0.48	—
ASMD150F	1.93	1.70	1.50	1.27	1.22	1.07	0.95	0.85	0.74	0.58	—
ASMD150F/33	1.96	1.73	1.50	1.26	1.20	1.03	0.91	0.80	0.68	0.51	—
ASMD185F	2.93	2.58	2.30	1.93	1.85	1.62	1.44	1.30	1.12	0.88	—
ASMD200F	2.63	2.34	2.04	1.73	1.66	1.45	1.30	1.16	1.00	0.80	—
ASMD250F	3.00	2.66	2.32	1.97	1.89	1.65	1.48	1.32	1.14	0.91	—
<b>femtoASMD</b>											
<b>12-15V – Surface-mount</b>											
femtoASMD005F	0.08	0.07	0.06	0.05	0.05	0.04	0.04	0.03	0.03	0.02	—
femtoASMD008F	0.13	0.11	0.10	0.08	0.08	0.07	0.06	0.06	0.05	0.04	—
femtoASMD010F/15	0.16	0.14	0.12	0.11	0.10	0.09	0.08	0.07	0.06	0.04	—
<b>picoASMD</b>											
<b>15V – Surface-mount</b>											
picoASMD010S	0.17	0.15	0.13	0.11	0.10	0.09	0.08	0.07	0.06	0.05	—
picoASMD012S	0.20	0.17	0.15	0.13	0.12	0.10	0.09	0.08	0.07	0.05	—
<b>nanoASMD</b>											
<b>13.2-48V – Surface-mount</b>											
nanoASMD010F	0.15	0.14	0.12	0.10	0.10	0.09	0.08	0.07	0.06	0.05	—
nanoASMD012F	0.20	0.17	0.15	0.13	0.12	0.11	0.10	0.09	0.08	0.07	—
nanoASMD016F	0.21	0.20	0.18	0.16	0.16	0.14	0.13	0.12	0.11	0.09	—
nanoASMD020F	0.34	0.30	0.26	0.22	0.20	0.17	0.15	0.13	0.11	0.08	—
nanoASMD025F	0.38	0.33	0.30	0.26	0.25	0.22	0.20	0.19	0.16	0.11	—
nanoASMD035F	0.58	0.51	0.44	0.38	0.35	0.31	0.28	0.24	0.21	0.16	—
nanoASMD050F/13.2	0.78	0.69	0.61	0.52	0.50	0.44	0.39	0.35	0.30	0.24	—
<b>microASMD</b>											
<b>13.2-30V – Surface-mount</b>											
microASMD005F	0.08	0.07	0.06	0.05	0.05	0.04	0.04	0.03	0.03	0.02	—
microASMD010F	0.15	0.13	0.12	0.10	0.10	0.09	0.08	0.06	0.06	0.05	—
microASMD050F	0.76	0.66	0.58	0.50	0.48	0.42	0.38	0.35	0.29	0.23	—
<b>miniASMD</b>											
<b>12-60V – Surface-mount</b>											
miniASMD010F	0.17	0.15	0.13	0.11	0.10	0.09	0.08	0.07	0.06	0.04	—
miniASMD014F	0.23	0.20	0.17	0.14	0.13	0.11	0.10	0.09	0.07	0.05	—
miniASMD020F	0.30	0.27	0.23	0.20	0.19	0.17	0.15	0.13	0.12	0.09	—
miniASMD030F	0.49	0.44	0.39	0.32	0.30	0.27	0.24	0.22	0.18	0.14	—
miniASMD050F	0.59	0.57	0.55	0.50	0.48	0.45	0.43	0.35	0.30	0.23	—
miniASMD075F	1.10	0.99	0.87	0.75	0.72	0.63	0.57	0.49	0.45	0.35	—
miniASMD075F/24	1.50	1.25	1.00	0.75	0.73	0.65	0.60	0.55	0.50	0.43	—
miniASMD075F/33	1.09	0.98	0.87	0.77	0.75	0.66	0.61	0.55	0.50	0.41	—
miniASMD0110F/16	1.68	1.49	1.30	1.10	1.05	0.92	0.83	0.75	0.64	0.50	—
miniASMD0110F/24	2.00	1.70	1.40	1.10	1.06	0.95	0.88	0.80	0.73	0.61	—
miniASMD0125F/16	2.00	1.69	1.47	1.25	1.17	1.03	0.92	0.90	0.69	0.53	—
miniASMD0150F/12	2.40	2.10	1.80	1.50	1.44	1.25	1.13	1.00	0.88	0.69	—
miniASMD0150F/16	2.40	2.10	1.80	1.50	1.44	1.25	1.13	1.00	0.88	0.69	—
miniASMD0150F/24	2.10	1.90	1.70	1.50	1.44	1.25	1.13	1.00	0.88	0.69	—

# PolySwitch Resettable Devices

## Automotive Devices

Table A2 – Thermal Derating [Hold Current (A) at Ambient Temperature (°C)] (Cont'd)

Part Number	Maximum Ambient Temperature										
	-40°C	-20°C	0°C	20°C	25°C	40°C	50°C	60°C	70°C	85°C	125°C
<b>miniASMDC</b>											
<b>12-60V – Surface-mount</b>											
miniASMDC200F/16	3.07	2.74	2.40	2.07	2.00	1.74	1.57	1.40	1.24	0.99	—
miniASMDC260F/12	3.40	3.16	3.00	2.60	2.54	2.32	2.18	2.00	1.90	1.69	—
miniASMDC260F/13.2	3.40	3.16	3.00	2.60	2.54	2.32	2.18	2.00	1.90	1.69	—
miniASMDC260F/16	3.50	3.20	3.00	2.60	2.53	2.30	2.15	2.00	1.85	1.63	—
<b>ASMDC</b>											
<b>24-60V – Surface-mount</b>											
ASMDC030F	0.49	0.43	0.37	0.31	0.30	0.25	0.22	0.19	0.16	0.12	—
ASMDC050F	0.86	0.75	0.65	0.54	0.50	0.43	0.37	0.32	0.26	0.18	—
ASMDC075F	1.17	1.04	0.90	0.77	0.75	0.64	0.57	0.50	0.44	0.34	—
ASMDC125F/33	2.02	1.78	1.55	1.31	1.25	1.08	0.96	0.84	0.72	0.54	—
ASMDC185F/33	2.83	2.50	2.20	1.85	1.74	1.53	1.37	1.22	1.04	0.80	—
ASMDC300F/24	4.70	4.19	3.70	3.17	3.00	2.66	2.41	2.20	1.90	1.50	—

# PolySwitch Resettable Devices

## Automotive Devices

### Figures A1-A3 - Thermal Derating Curves for Automotive Devices

(Cont'd)

A = AGRF  
B = AHRF



AHEF



A = ASMD, femtoASMDC,  
picoASMDC, nanoASMDC  
microASMD, miniASMDC,  
ASMDC  
B = AHS



# PolySwitch Resettable Devices

## Automotive Devices

### Table A3 – Electrical Characteristics for Automotive Devices

Part Number	$I_H(A)@$	$I_H(A)@$	$I_T$ (A)	$V_{MAX}$ (V <sub>DC</sub> )	$I_{MAX}$ (A)	$P_{D\ TYP}$ (W)	Max. Time-to-trip		$R_{MIN}$ (Ω)	$R_{1MAX}$ (Ω)	$R_{aMAX}$ (Ω)	Figure for Dimensions
	$R_{1MAX}$	$R_{aMAX}$					(A)	(s)				
<b>AGRF</b>												
<b>16V – Radial-leaded</b>												
AGRF400	4.0	3.0	7.6	16	100	2.5	20.0	2.0	0.0186	0.0610	0.0850	A4, A7, A8
AGRF500	5.0	4.3	9.4	16	100	2.7	25.0	2.5	0.0140	0.0340	0.0480	A4, A7, A8
AGRF600	6.0	5.3	10.7	16	100	2.8	30.0	3.5	0.0095	0.0280	0.0320	A4, A7, A8
AGRF700	7.0	6.5	13.2	16	100	3.0	35.0	4.0	0.0066	0.0200	0.0220	A4, A7, A8
AGRF800	8.0	7.6	15.0	16	100	3.2	40.0	5.5	0.0049	0.0175	0.0181	A4, A7, A8
AGRF900	9.0	8.6	16.5	16	100	3.4	45.0	6.0	0.0041	0.0135	0.0140	A4, A7, A8
AGRF1000	10.0	9.6	18.5	16	100	3.6	50.0	7.0	0.0034	0.0102	0.0106	A4, A7, A8
AGRF1100	11.0	10.5	20.3	16	100	3.7	55.0	7.5	0.0033	0.0089	0.0093	A4, A7, A8
AGRF1200	12.0	11.5	22.1	16	100	4.2	60.0	8.0	0.0030	0.0086	0.0091	A4, A7, A8
AGRF1400	14.0	13.0	27.3	16	100	4.6	70.0	9.0	0.0022	0.0064	0.0067	A4, A7, A8
<b>AHRF (High Temperature)</b>												
<b>30V – Radial-leaded</b>												
AHRF050	0.5	0.5	1.0	30	40	0.9	2.5	3.0	0.3500	1.100	1.100	A7, A8, A9
AHRF070	0.7	0.7	1.4	30	40	1.4	3.5	3.2	0.2300	0.800	0.800	A7, A8, A10
AHRF100	1.0	1.0	1.9	30	40	1.4	5.0	6.2	0.1500	0.430	0.430	A7, A8, A9
<b>AHRF (High Temperature)</b>												
<b>16V – Radial-leaded</b>												
AHRF200	2.0	2.0	3.8	16	100	1.4	10.0	4.8	0.0390	0.1100	0.1100	A7, A8, A9
AHRF300	3.0	3.0	6.5	16	100	3.0	15.0	5.0	0.0290	0.0790	0.0790	A4, A7, A8
AHRF400	4.0	4.0	7.4	16	100	3.3	20.0	5.0	0.0210	0.0600	0.0600	A4, A7, A8
AHRF450	4.5	4.5	8.7	16	100	3.6	22.5	4.0	0.0170	0.0540	0.0540	A4, A7, A8
AHRF550	5.5	5.5	10.0	16	100	3.5	27.5	6.0	0.0130	0.0370	0.0370	A4, A7, A8
AHRF600	6.0	6.0	12.0	16	100	4.1	30.0	6.5	0.0100	0.0320	0.0320	A4, A7, A8
AHRF650	6.5	6.5	13.7	16	100	4.3	32.5	7.0	0.0090	0.0260	0.0260	A4, A7, A8
AHRF700	7.0	7.0	13.1	16	100	4.0	35.0	7.0	0.0087	0.0250	0.0250	A4, A7, A8
AHRF750	7.5	7.5	14.8	16	100	4.5	37.5	8.0	0.0074	0.0220	0.0220	A4, A7, A8
AHRF800	8.0	8.0	15.0	16	100	4.2	40.0	8.0	0.0072	0.0200	0.0200	A4, A7, A8
AHRF900	9.0	9.0	18.5	16	100	5.0	45.0	11.5	0.0061	0.0170	0.0170	A4, A7, A8
AHRF1000	10.0	10.0	20.5	16	100	5.3	50.0	10.5	0.0051	0.0150	0.0150	A4, A7, A8
AHRF1100	11.0	11.0	21.2	16	100	5.5	55.0	11.0	0.0048	0.0130	0.0130	A4, A7, A8
AHRF1300	13.0	13.0	27.0	16	100	6.9	65.0	15.0	0.0034	0.0100	0.0100	A4, A7, A8
AHRF1400	14.0	14.0	28.3	16	100	6.9	70.0	15.5	0.0029	0.0090	0.0090	A4, A7, A8
AHRF1500	15.0	15.0	33.0	16	100	7.0	75.0	20.0	0.0027	0.0092	0.0092	A4, A7, A8



# PolySwitch Resettable Devices

## Automotive Devices

### Table A3 – Electrical Characteristics (Cont'd)

Part Number	$I_H(A)@$	$I_H(A)@$	$I_T$ (A)	$V_{MAX}$ (V <sub>DC</sub> )	$I_{MAX}$ (A)	$P_{D\,TYP}$ (W)	Max. Time-to-trip		$R_{MIN}$ ( $\Omega$ )	$R_{1MAX}$ ( $\Omega$ )	$R_{aMAX}$ ( $\Omega$ )	Figure for Dimensions
	$R_{1MAX}$	$R_{aMAX}$					(A)	(s)				
<b>AHEF (High Temperature)</b>												
<b>32V – Radial-leaded</b>												
AHEF050	0.5	0.5	1.0	32	100	0.9	2.5	3.0	0.3500	1.100	1.100	A7, A8, A9
AHEF070	0.7	0.7	1.4	32	100	1.4	3.5	3.2	0.2300	0.800	0.800	A7, A9, A10
AHEF100	1.0	1.0	1.9	32	100	1.4	5.0	6.2	0.1500	0.430	0.430	A7, A8, A9
AHEF300	3.0	3.0	6.0	32	100	3.2	15.0	5.0	0.0350	0.110	0.110	A7, A8, A11
AHEF500	5.0	5.0	10.0	32	100	5.3	25.0	9.0	0.0150	0.040	0.040	A7, A8, A11
AHEF750	7.5	7.5	15.0	32	100	6.5	37.5	13.0	0.0074	0.023	0.023	A7, A8, A11
AHEF1000	10.0	10.0	20.0	32	100	7.0	50.0	15.0	0.0060	0.016	0.016	A7, A8, A11
<b>AHS (High Temperature)</b>												
<b>16V – Surface-mount</b>												
AHS080-2018	0.80	0.80	2.00	16	70	1.5	8.0	9.0	0.130	0.550	0.550	A5
AHS120	1.20	1.20	2.30	16	50	2.2	8.0	2.0	0.150	0.340	0.340	A6
AHS160	1.60	1.60	3.20	16	70	2.2	8.0	15.0	0.050	0.150	0.150	A6
AHS200	2.00	2.00	4.00	16	70	2.3	8.0	13.4	0.050	0.140	0.140	A6
AHS300	3.00	3.00	6.00	16	70	3.0	15.0	8.0	0.024	0.083	0.083	A6
<b>ASMD</b>												
<b>16-60V – Surface-mount</b>												
ASMD030F	0.23	0.23	0.59	60	10	1.1	1.15	12.0	0.980	4.800	4.800	A6
ASMD050F	0.37	0.37	0.98	60	10	1.7	1.95	20.0	0.290	1.400	1.400	A6
ASMD075F	0.60	0.60	1.48	30	40	1.1	3.00	20.0	0.290	1.000	1.000	A6
ASMD100F	0.90	0.90	2.16	30	40	1.1	4.50	20.0	0.098	0.480	0.480	A6
ASMD125F	1.04	1.04	2.46	16	40	1.1	5.20	20.0	0.057	0.250	0.250	A6
ASMD150F	1.27	1.27	2.95	16	40	1.2	6.35	25.0	0.049	0.250	0.250	A6
ASMD150F/33	1.20	1.20	2.88	33	40	1.9	6.00	14.0	0.068	0.230	0.230	A6
ASMD185F	1.85	1.85	3.70	16	40	1.5	9.25	11.3	0.032	0.126	0.126	A6
ASMD200F	1.73	1.73	3.93	16	40	1.2	8.65	30.0	0.050	0.120	0.120	A6
ASMD250F	1.97	1.97	5.00	16	40	1.2	9.85	30.0	0.035	0.085	0.085	A6
<b>femtoASMD</b>												
<b>12-15V – Surface-mount</b>												
femtoASMD005F	0.05	0.05	0.15	15	10	0.50	0.50	0.10	3.80	30.00	30.00	A12
femtoASMD008F	0.08	0.08	0.20	12	10	0.50	0.60	0.10	2.80	14.00	14.00	A12
femtoASMD010F/15	0.10	0.10	0.30	15	10	0.50	0.70	0.10	2.00	14.00	14.00	A12
<b>picoASMD</b>												
<b>15V – Surface-mount</b>												
picoASMD010S	0.10	0.10	0.30	15	20	0.50	0.50	0.60	1.50	11.00	11.00	A12
picoASMD012S	0.12	0.12	0.30	15	20	0.50	1.00	0.10	1.50	9.00	9.00	A12
<b>nanoASMD</b>												
<b>13.2-48V – Surface-mount</b>												
nanoASMD010F	0.10	0.10	0.25	60	10	0.80	0.50	1.00	1.60	15.00	15.00	A12
nanoASMD012F	0.12	0.12	0.39	48	10	0.50	1.00	0.20	1.40	6.50	6.50	A12
nanoASMD016F	0.16	0.16	0.45	48	10	0.50	1.00	0.30	1.10	5.00	5.00	A12
nanoASMD020F	0.20	0.20	0.42	24	100	0.60	8.00	0.10	0.65	3.10	3.10	A12
nanoASMD025F	0.25	0.25	0.58	16	100	0.60	8.00	0.01	0.40	2.10	2.10	A12
nanoASMD035F	0.35	0.35	0.75	16	20	0.60	3.50	0.10	0.45	1.35	1.35	A12
nanoASMD050F/13.2	0.50	0.50	1.10	13.2	70	0.80	8.00	0.10	0.20	0.75	0.75	A12
<b>microASMD</b>												
<b>13.2-30V – Surface-mount</b>												
microASMD005F	0.05	0.05	0.15	30	10	1.00	0.25	1.50	3.60	50.00	50.00	A12
microASMD010F	0.10	0.10	0.25	30	10	0.80	0.50	1.00	2.10	15.00	15.00	A12
microASMD050F	0.50	0.50	1.00	13.2	40	0.80	8.00	0.05	0.25	0.90	0.90	A12

# PolySwitch Resettable Devices

## Automotive Devices

### Table A3 – Electrical Characteristics (Cont'd)

Part Number	$I_H(A)@$	$I_H(A)@$	$I_T$ (A)	$V_{MAX}$ (V <sub>DC</sub> )	$I_{MAX}$ (A)	$P_{D Typ}$ (W)	Max. Time-to-trip		$R_{MIN}$ (Ω)	$R_{1MAX}$ (Ω)	$R_{aMAX}$ (Ω)	Figure for Dimensions
	$R_{1MAX}$	$R_{aMAX}$					(A)	(s)				
<b>miniASMDC</b>												
<b>12-60V – Surface-mount</b>												
miniASMDC010F	0.10	0.10	0.30	60	40	0.75	0.50	5.00	0.70	12.70	12.70	A12
miniASMDC014F	0.14	0.14	0.28	60	10	0.75	8.00	0.01	1.50	6.00	6.00	A12
miniASMDC020F	0.20	0.20	0.40	30	10	0.80	8.00	0.02	0.60	3.30	3.30	A12
miniASMDC030F	0.30	0.30	0.60	30	40	0.80	8.00	0.10	0.20	1.75	1.75	A12
miniASMDC050F	0.50	0.50	1.00	24	100	0.80	8.00	0.15	0.15	1.00	1.00	A12
miniASMDC075F	0.75	0.75	1.50	13.2	100	1.00	8.00	0.20	0.11	0.45	0.45	A12
miniASMDC075F/24	0.75	0.75	1.50	24	40	0.80	8.00	0.30	0.09	0.29	0.29	A12
miniASMDC075F/33	0.75	0.75	1.60	33	100	1.00	8.00	1.00	0.11	0.39	0.39	A12
miniASMDC110F/16	1.10	1.10	2.20	16	100	0.80	8.00	0.30	0.06	0.18	0.18	A12
miniASMDC110F/24	1.10	1.10	2.20	24	20	0.80	8.00	0.50	0.06	0.18	0.18	A12
miniASMDC125F/16	1.25	1.25	2.50	16	100	0.80	8.00	0.40	0.05	0.14	0.14	A12
miniASMDC150F/12	1.50	1.50	2.80	12	100	0.80	8.00	0.50	0.04	0.11	0.11	A12
miniASMDC150F/16	1.50	1.50	2.80	16	100	0.80	8.00	0.50	0.04	0.11	0.11	A12
miniASMDC150F/24	1.50	1.50	3.00	24	20	1.00	8.00	1.50	0.04	0.12	0.12	A12
miniASMDC200F/16	2.00	2.00	4.00	16	40	1.20	8.00	5.00	0.02	0.085	0.085	A12
miniASMDC260F/12	2.60	2.60	5.00	12	100	1.00	8.00	5.00	0.015	0.047	0.047	A12
miniASMDC260F/13.2	2.60	2.60	5.00	13.2	100	1.20	8.00	5.00	0.015	0.05	0.05	A12
miniASMDC260F/16	2.60	2.60	5.00	16	100	1.20	8.00	5.00	0.015	0.05	0.05	A12
<b>ASMDC</b>												
<b>24-60V – Surface-mount</b>												
ASMDC030F	0.30	0.30	0.60	60	10	1.50	1.50	3.00	0.30	3.40	3.40	A12
ASMDC050F	0.50	0.50	1.00	60	10	1.50	2.50	4.00	0.15	1.20	1.20	A12
ASMDC075F	0.75	0.75	1.50	33	40	1.50	8.00	0.30	0.10	0.61	0.61	A12
ASMDC125F/33	1.25	1.25	2.50	33	40	1.50	8.00	2.00	0.04	0.25	0.25	A12
ASMDC185F/33	1.85	1.85	3.70	33	40	1.70	8.00	2.50	0.05	0.15	0.15	A12
ASMDC300F/24	3.00	3.00	6.00	24	40	1.70	8.00	5.00	0.015	0.072	0.072	A12

#### Notes:

- $I_H$  : Hold current: maximum current device will pass without interruption in 25°C, unless otherwise specified (20°C for ASMD).
- $I_T$  : Trip current: minimum current that will switch the device from low-resistance to high-resistance in 25°C still air, unless otherwise specified.
- $V_{MAX}$  : Maximum voltage device can withstand without damage at rated current.
- $I_{MAX}$  : Maximum fault current device can withstand without damage at rated voltage.
- $P_D$  : Power dissipated from device when in the tripped state in 25°C still air, unless otherwise specified.
- $R_{MIN}$  : Minimum resistance of device as supplied at 25°C, unless otherwise specified.
- $R_{1MAX}$  : Maximum resistance of device when measured one hour post reflow (surface-mount device) or one hour post trip (radial-leaded device) at 25°C unless otherwise specified.
- $R_{aMAX}$  : Maximum functional resistance of device after being subjected to the stresses described in PS400 at 25°C, unless otherwise specified.
- $R_{sMIN}$  : Minimum functional resistance of device after being subjected to the stresses described in PS400 at 25°C, unless otherwise specified.

**PolySwitch Resettable Devices**  
Automotive Devices

**Figures A4-A12 – Dimension Figures for Automotive Devices**



# PolySwitch Resettable Devices

## Automotive Devices

### Table A4 — Dimensions in Millimeters and (Inches)

Part Number	A		B		C		D		E		F		G		H	J	Figure
	Min	Max	Min	Max	Min	Max	Min	Max	Min	Max	Min	Max	Min	Max	Typ	Max	
<b>AGRF</b>																	
<b>16V — Radial-leaded</b>																	
AGRF400	—	8.9 (0.350)	—	14.1 (0.56)	4.3 (0.17)	5.8 (0.20)	7.6 (0.3)	—	—	3.0 (0.12)	1.2 (0.15)	—	—	3.10 (0.120)	1.24 (0.049)	1.4 (0.06)	A4, A7, A8
AGRF500	—	10.4 (0.410)	—	15.6 (0.61)	4.3 (0.17)	5.8 (0.20)	7.6 (0.3)	—	—	3.0 (0.12)	1.2 (0.05)	—	—	3.94 (0.155)	1.24 (0.049)	1.6 (0.06)	A4, A7, A8
AGRF600	—	10.7 (0.420)	—	18.4 (0.73)	4.3 (0.17)	5.8 (0.20)	7.6 (0.3)	—	—	3.0 (0.12)	1.2 (0.05)	—	—	4.07 (0.160)	1.24 (0.049)	1.6 (0.06)	A4, A7, A8
AGRF700	—	11.2 (0.440)	—	21.0 (0.73)	4.3 (0.17)	5.8 (0.20)	7.6 (0.3)	—	—	3.0 (0.12)	1.2 (0.05)	—	—	4.49 (0.177)	1.24 (0.049)	1.7 (0.07)	A4, A7, A8
AGRF800	—	12.7 (0.500)	—	22.2 (0.88)	4.3 (0.17)	5.8 (0.20)	7.6 (0.3)	—	—	3.0 (0.12)	1.2 (0.05)	—	—	5.08 (0.200)	1.24 (0.049)	1.8 (0.07)	A4, A7, A8
AGRF900	—	14.0 (0.550)	—	23.0 (0.91)	4.3 (0.17)	5.8 (0.20)	7.6 (0.3)	—	—	3.0 (0.12)	1.2 (0.05)	—	—	5.69 (0.224)	1.24 (0.049)	2.0 (0.08)	A4, A7, A8
AGRF1000	—	16.51 (0.650)	—	25.7 (1.01)	4.3 (0.17)	5.8 (0.20)	7.6 (0.3)	—	—	3.0 (0.12)	1.2 (0.05)	—	—	6.96 (0.274)	1.24 (0.049)	2.0 (0.08)	A4, A7, A8
AGRF1100	—	17.5 (0.690)	—	26.5 (1.04)	4.3 (0.17)	5.8 (0.20)	7.6 (0.3)	—	—	3.0 (0.12)	1.2 (0.05)	—	—	7.47 (0.294)	1.24 (0.049)	2.4 (0.09)	A4, A7, A8
AGRF1200	—	17.5 (0.690)	—	28.8 (1.14)	9.4 (0.37)	10.9 (0.43)	7.6 (0.3)	—	—	3.5 (0.14)	1.4 (0.06)	—	—	4.83 (0.190)	1.45 (0.057)	1.5 (0.06)	A4, A7, A8
AGRF1400	—	23.5 (0.925)	—	28.7 (1.13)	9.4 (0.37)	10.9 (0.43)	7.6 (0.3)	—	—	3.5 (0.14)	1.4 (0.06)	—	—	7.82 (0.308)	1.45 (0.057)	1.9 (0.07)	A4, A7, A8
<b>AHRF (High Temperature)</b>																	
<b>30V — Radial-leaded</b>																	
AHRF050	—	7.4 (0.29)	—	12.7 (0.50)	4.3 (0.17)	5.8 (0.23)	7.6 (0.30)	—	—	3.3 (0.13)	1.2 (0.05)	—	—	—	1.24 (0.049)	1.6 (0.06)	A7, A8, A9
AHRF070	—	6.9 (0.27)	—	10.8 (0.43)	4.3 (0.17)	5.8 (0.23)	7.6 (0.30)	—	—	3.3 (0.13)	1.2 (0.05)	—	—	—	1.24 (0.049)	1.6 (0.06)	A7, A8, A10
AHRF100	—	9.7 (0.38)	—	13.6 (0.54)	4.3 (0.17)	5.8 (0.23)	7.6 (0.30)	—	—	3.0 (0.12)	1.2 (0.05)	—	—	—	1.24 (0.049)	1.6 (0.06)	A7, A8, A9

# PolySwitch Resettable Devices

## Automotive Devices

**Table A4 — Dimensions for Automotive Devices in Millimeters (Inches)**  
(Cont'd)

Part Number	A		B		C		D		E		F		G		H	J	Figure
	Min	Max	Min	Max	Min	Max	Min	Max	Min	Max	Min	Max	Min	Max	Typ	Max	
<b>AHRF (High Temperature)</b>																	
<b>16V — Radial-leaded</b>																	
AHRF200	—	9.4 (0.37)	—	14.4 (0.57)	4.3 (0.17)	5.8 (0.23)	7.6 (0.30)	—	—	3.0 (0.12)	1.2 (0.05)	—	—	—	1.24 (0.049)	1.6 (0.06)	A7, A8, A9
AHRF300	—	8.8 (0.35)	—	13.8 (0.55)	4.3 (0.17)	5.8 (0.23)	7.6 (0.30)	—	—	3.0 (0.12)	1.2 (0.05)	—	—	—	1.24 (0.049)	1.6 (0.06)	A4, A7, A8
AHRF400	—	10.0 (0.39)	—	15.0 (0.59)	4.3 (0.17)	5.8 (0.23)	7.6 (0.30)	—	—	3.0 (0.12)	1.2 (0.05)	—	—	—	1.24 (0.049)	1.6 (0.06)	A4, A7, A8
AHRF450	—	10.4 (0.41)	—	15.6 (0.61)	4.3 (0.17)	5.8 (0.23)	7.6 (0.30)	—	—	3.0 (0.12)	1.2 (0.05)	—	—	3.94 (0.155)	1.24 (0.049)	1.6 (0.06)	A4, A7, A8
AHRF550	—	11.2 (0.44)	—	18.9 (0.74)	4.3 (0.17)	5.8 (0.23)	7.6 (0.30)	—	—	3.0 (0.12)	1.2 (0.05)	—	—	—	1.24 (0.049)	1.6 (0.06)	A4, A7, A8
AHRF600	—	11.2 (0.44)	—	21.0 (0.73)	4.3 (0.17)	5.8 (0.23)	7.6 (0.30)	—	—	3.0 (0.12)	1.2 (0.05)	—	—	4.49 (0.177)	1.24 (0.049)	1.7 (0.07)	A4, A7, A8
AHRF650	—	12.7 (0.50)	—	22.2 (0.88)	4.3 (0.17)	5.8 (0.23)	7.6 (0.30)	—	—	3.0 (0.12)	1.2 (0.05)	—	—	5.08 (0.200)	1.24 (0.049)	1.8 (0.07)	A4, A7, A8
AHRF700	—	14.0 (0.55)	—	21.9 (0.86)	4.3 (0.17)	5.8 (0.23)	7.6 (0.30)	—	—	3.0 (0.12)	1.2 (0.05)	—	—	—	1.24 (0.049)	1.6 (0.06)	A4, A7, A8
AHRF750	—	14.0 (0.55)	—	23.5 (0.93)	4.3 (0.17)	5.8 (0.23)	7.6 (0.30)	—	—	3.0 (0.12)	1.2 (0.05)	—	—	5.69 (0.224)	1.24 (0.049)	2.0 (0.08)	A4, A7, A8
AHRF800	—	16.5 (0.65)	—	22.5 (0.88)	4.3 (0.17)	5.8 (0.23)	7.6 (0.30)	—	—	3.0 (0.12)	1.2 (0.05)	—	—	—	1.24 (0.049)	1.6 (0.06)	A4, A7, A8
AHRF900	—	16.5 (0.65)	—	25.7 (1.01)	4.3 (0.17)	5.8 (0.23)	7.6 (0.30)	—	—	3.0 (0.12)	1.2 (0.05)	—	—	—	—	—	A4, A7, A8
AHRF1000	—	17.5 (0.69)	—	26.5 (1.04)	9.4 (0.37)	10.9 (0.43)	7.6 (0.30)	—	—	3.0 (0.12)	1.2 (0.05)	—	—	7.47 (0.294)	1.24 (0.049)	1.5 (0.06)	A4, A7, A8
AHRF1100	—	21.0 (0.83)	—	26.1 (1.03)	9.4 (0.37)	10.9 (0.43)	7.6 (0.30)	—	—	3.0 (0.12)	1.2 (0.05)	—	—	—	1.24 (0.049)	1.6 (0.06)	A4, A7, A8
AHRF1300	—	23.5 (0.925)	—	28.7 (1.13)	9.4 (0.37)	10.9 (0.43)	7.6 (0.30)	—	—	3.5 (0.14)	1.4 (0.06)	—	—	7.82 (0.308)	1.45 (0.057)	1.9 (0.08)	A4, A7, A8
AHRF1400	—	23.5 (0.93)	—	28.7 (1.13)	9.4 (0.37)	10.9 (0.43)	7.6 (0.30)	—	—	3.6 (0.14)	1.4 (0.06)	—	—	—	1.24 (0.049)	1.6 (0.06)	A4, A7, A8
AHRF1500	—	23.5 (0.93)	—	28.7 (1.13)	9.4 (0.37)	10.9 (0.43)	7.6 (0.30)	—	—	3.5 (0.14)	1.4 (0.06)	—	—	7.82 (0.308)	—	—	A4, A7, A8
<b>AHEF (High Temperature)</b>																	
<b>32V — Radial-leaded</b>																	
AHEF050	—	7.4 (0.29)	—	12.7 (0.50)	4.3 (0.17)	5.8 (0.23)	7.6 (0.30)	—	—	3.3 (0.13)	—	—	—	—	—	—	A7, A8, A9
AHEF070	—	6.9 (0.27)	—	10.8 (0.43)	4.3 (0.17)	5.8 (0.23)	7.6 (0.30)	—	—	3.0 (0.12)	—	—	—	—	—	—	A7, A8, A10
AHEF100	—	9.7 (0.38)	—	13.6 (0.54)	4.3 (0.17)	5.8 (0.23)	7.6 (0.30)	—	—	3.0 (0.12)	—	—	—	—	—	—	A7, A8, A9
AHEF300	—	10.2 (0.40)	—	15.5 (0.61)	4.32 (0.17)	5.84 (0.23)	7.6 (0.30)	—	—	3.8 (0.15)	—	—	—	—	—	—	A7, A8, A11
AHEF500	—	14.0 (0.55)	—	24.1 (0.95)	4.3 (0.17)	5.8 (0.23)	11.5 (0.45)	—	—	3.8 (0.15)	—	—	—	—	—	—	A7, A8, A11
AHEF750	—	21.1 (0.83)	—	24.9 (0.98)	9.4 (0.37)	10.9 (0.43)	7.6 (0.30)	—	—	3.8 (0.15)	—	—	—	—	—	—	A7, A8, A11
AHEF1000	—	23.5 (0.93)	—	27.9 (1.10)	9.4 (0.37)	10.9 (0.43)	7.6 (0.30)	—	—	4.0 (0.16)	—	—	—	—	—	—	A7, A8, A11

# PolySwitch Resettable Devices

## Automotive Devices

Table A4 – Dimensions in Millimeters and (Inches)

(Cont'd)

Part Number	A		B		C		D		E		F		G		H		Figure
	Min	Max	Min	Max	Min	Max	Min	Max	Min	Max	Min	Max	Min	Max	Min	Max	
<b>AHS (High Temperature)</b>																	
<b>16V – Surface-mount</b>																	
AHS080-2018	4.72 (0.186)	5.44 (0.214)	—	1.52 (0.060)	4.22 (0.166)	4.93 (0.194)	0.25 (0.010)	0.36 (0.014)	0.25 (0.010)	0.36 (0.014)	0.30 (0.012)	0.46 (0.018)	—	—	—	—	A5
AHS120	6.73 (0.265)	7.98 (0.314)	—	3.00 (0.118)	4.8 (0.19)	5.44 (0.214)	0.56 (0.022)	0.71 (0.028)	0.56 (0.022)	0.71 (0.028)	2.16 (0.085)	2.41 (0.095)	0.66 (0.026)	1.37 (0.054)	0.43 (0.017)	—	A6
AHS160	8.00 (0.315)	9.40 (0.370)	—	3.00 (0.118)	6.0 (0.24)	6.71 (0.264)	0.56 (0.022)	0.71 (0.028)	0.56 (0.022)	0.71 (0.028)	3.68 (0.145)	3.94 (0.155)	0.66 (0.026)	1.37 (0.054)	0.43 (0.017)	—	A6
AHS200	8.00 (0.315)	9.40 (0.370)	—	3.00 (0.118)	6.0 (0.240)	6.71 (0.264)	0.56 (0.022)	0.71 (0.028)	0.56 (0.022)	0.71 (0.028)	3.68 (0.145)	3.94 (0.155)	0.66 (0.026)	1.37 (0.054)	0.43 (0.017)	—	A6
AHS300	8.00 (0.315)	9.40 (0.370)	—	3.00 (0.118)	6.0 (0.240)	6.71 (0.264)	0.56 (0.022)	0.71 (0.028)	0.56 (0.022)	0.71 (0.028)	3.68 (0.145)	3.94 (0.155)	0.66 (0.026)	1.37 (0.054)	0.43 (0.017)	—	A6
<b>ASMD</b>																	
<b>16-60V – Surface-mount</b>																	
ASMD030F	6.73 (0.265)	7.98 (0.314)	—	3.18 (0.125)	4.8 (0.19)	5.44 (0.214)	0.56 (0.022)	0.71 (0.028)	0.56 (0.022)	0.71 (0.028)	2.16 (0.085)	2.41 (0.095)	0.66 (0.026)	1.37 (0.054)	0.43 (0.017)	—	A6
ASMD050F	6.73 (0.265)	7.98 (0.314)	—	3.18 (0.125)	4.8 (0.19)	5.44 (0.214)	0.56 (0.022)	0.71 (0.028)	0.56 (0.022)	0.71 (0.028)	2.16 (0.085)	2.41 (0.095)	0.66 (0.026)	1.37 (0.054)	0.43 (0.017)	—	A6
ASMD075F	6.73 (0.265)	7.98 (0.314)	—	3.18 (0.125)	4.8 (0.19)	5.44 (0.214)	0.56 (0.022)	0.71 (0.028)	0.56 (0.022)	0.71 (0.028)	2.16 (0.085)	2.41 (0.095)	0.66 (0.026)	1.37 (0.054)	0.43 (0.017)	—	A6
ASMD100F	6.73 (0.265)	7.98 (0.314)	—	3.00 (0.118)	4.8 (0.19)	5.44 (0.214)	0.56 (0.022)	0.71 (0.028)	0.56 (0.022)	0.71 (0.028)	2.16 (0.085)	2.41 (0.095)	0.66 (0.026)	1.37 (0.054)	0.43 (0.017)	—	A6
ASMD125F	6.73 (0.265)	7.98 (0.314)	—	3.00 (0.118)	4.8 (0.19)	5.44 (0.214)	0.56 (0.022)	0.71 (0.028)	0.56 (0.022)	0.71 (0.028)	2.16 (0.085)	2.41 (0.095)	0.66 (0.026)	1.37 (0.054)	0.43 (0.017)	—	A6
ASMD150F	8.00 (0.315)	9.40 (0.370)	—	3.00 (0.118)	6.0 (0.24)	6.71 (0.264)	0.56 (0.022)	0.71 (0.028)	0.56 (0.022)	0.71 (0.028)	3.68 (0.145)	3.94 (0.155)	0.66 (0.026)	1.37 (0.054)	0.43 (0.017)	—	A6
ASMD150F/33	8.00 (0.315)	9.40 (0.370)	—	3.00 (0.118)	6.0 (0.24)	6.71 (0.264)	0.56 (0.022)	0.71 (0.028)	0.56 (0.022)	0.71 (0.028)	3.68 (0.145)	3.94 (0.155)	0.66 (0.026)	1.37 (0.054)	0.43 (0.017)	—	A6
ASMD185F	8.00 (0.315)	9.40 (0.370)	—	3.00 (0.118)	6.0 (0.24)	6.71 (0.264)	0.56 (0.022)	0.71 (0.028)	0.56 (0.022)	0.71 (0.028)	3.68 (0.145)	3.94 (0.155)	0.66 (0.026)	1.37 (0.054)	0.43 (0.017)	—	A6
ASMD200F	8.00 (0.315)	9.40 (0.370)	—	3.00 (0.118)	6.0 (0.24)	6.71 (0.264)	0.56 (0.022)	0.71 (0.028)	0.56 (0.022)	0.71 (0.028)	3.68 (0.145)	3.94 (0.155)	0.66 (0.026)	1.37 (0.054)	0.43 (0.017)	—	A6
ASMD250F	8.00 (0.315)	9.40 (0.370)	—	3.00 (0.118)	6.0 (0.24)	6.71 (0.264)	0.56 (0.022)	0.71 (0.028)	0.56 (0.022)	0.71 (0.028)	3.68 (0.145)	3.94 (0.155)	0.66 (0.026)	1.37 (0.054)	0.43 (0.017)	—	A6
<b>femtoASMD</b>																	
<b>12-15V – Surface-mount</b>																	
femtoASMD005F	1.40 (0.055)	1.80 (0.071)	—	0.45 (0.017)	0.85 (0.033)	0.60 (0.023)	1.00 (0.039)	0.10 (0.004)	0.50 (0.020)	0.075 (0.003)	—	—	—	—	—	—	A12
femtoASMD008F	1.40 (0.055)	1.80 (0.071)	—	0.45 (0.017)	0.85 (0.033)	0.60 (0.023)	1.00 (0.039)	0.10 (0.004)	0.50 (0.020)	0.075 (0.003)	—	—	—	—	—	—	A12
femtoASMD010F/15	1.40 (0.055)	1.80 (0.071)	—	0.45 (0.017)	0.85 (0.033)	0.60 (0.023)	1.00 (0.039)	0.10 (0.004)	0.50 (0.020)	0.075 (0.003)	—	—	—	—	—	—	A12
<b>picoASMD</b>																	
<b>15V – Surface-mount</b>																	
picoASMD010S	2.00 (0.079)	2.20 (0.087)	—	0.60 (0.023)	1.00 (0.040)	1.30 (0.051)	1.50 (0.059)	0.25 (0.010)	0.75 (0.030)	0.076 (0.003)	—	—	—	—	—	—	A12
picoASMD012S	2.00 (0.079)	2.20 (0.087)	—	0.44 (0.017)	0.68 (0.027)	1.30 (0.051)	1.50 (0.059)	0.25 (0.010)	0.75 (0.030)	0.076 (0.003)	—	—	—	—	—	—	A12

# PolySwitch Resettable Devices

## Automotive Devices

### Table A4 – Dimensions in Millimeters and (Inches)

(Cont'd)

Part Number	A		B		C		D		E		Figure
	Min	Max	Min	Max	Min	Max	Min	Max	Min	Max	
<b>nanoASMDC</b>											
<b>13.2-48V – Surface-mount</b>											
nanoASMDC010F	3.00 (0.118)	3.40 (0.134)	0.62 (0.024)	1.00 (0.039)	1.37 (0.054)	1.80 (0.071)	0.25 (0.010)	0.75 (0.030)	0.076 (0.003)	—	A12
nanoASMDC012F	3.00 (0.118)	3.40 (0.134)	0.62 (0.024)	1.00 (0.039)	1.37 (0.054)	1.80 (0.071)	0.25 (0.010)	0.75 (0.030)	0.076 (0.003)	—	A12
nanoASMDC016F	3.00 (0.118)	3.40 (0.134)	0.62 (0.024)	1.00 (0.039)	1.37 (0.054)	1.80 (0.071)	0.25 (0.010)	0.75 (0.030)	0.076 (0.003)	—	A12
nanoASMDC020F	3.00 (0.118)	3.40 (0.134)	0.58 (0.023)	0.82 (0.032)	1.37 (0.054)	1.80 (0.071)	0.25 (0.010)	0.75 (0.030)	0.076 (0.003)	—	A12
nanoASMDC025F	3.00 (0.118)	3.40 (0.134)	0.58 (0.023)	0.82 (0.032)	1.37 (0.054)	1.80 (0.071)	0.25 (0.010)	0.75 (0.030)	0.076 (0.003)	—	A12
nanoASMDC035F	3.00 (0.118)	3.40 (0.134)	0.58 (0.023)	0.82 (0.032)	1.37 (0.054)	1.80 (0.071)	0.25 (0.010)	0.75 (0.030)	0.076 (0.003)	—	A12
nanoASMDC050F/13.2	3.00 (0.118)	3.40 (0.134)	0.50 (0.019)	0.74 (0.029)	1.37 (0.054)	1.80 (0.071)	0.25 (0.010)	0.75 (0.030)	0.076 (0.003)	—	A12
<b>microASMD</b>											
<b>13.2-30V – Surface-mount</b>											
microASMD005F	3.0 (0.118)	3.43 (0.135)	0.50 (0.019)	0.85 (0.034)	2.35 (0.092)	2.80 (0.110)	0.25 (0.010)	0.75 (0.030)	0.076 (0.003)	—	A12
microASMD010F	3.0 (0.118)	3.43 (0.135)	0.50 (0.019)	0.85 (0.034)	2.35 (0.092)	2.80 (0.110)	0.25 (0.010)	0.75 (0.030)	0.076 (0.003)	—	A12
microASMD050F	3.0 (0.118)	3.43 (0.135)	0.38 (0.015)	0.62 (0.025)	2.35 (0.092)	2.80 (0.110)	0.25 (0.010)	0.75 (0.030)	0.076 (0.003)	—	A12
<b>miniASMDC</b>											
<b>12-60V – Surface-mount</b>											
miniASMDC010F	4.37 (0.172)	4.73 (0.186)	0.635 (0.025)	0.89 (0.035)	3.07 (0.121)	3.41 (0.134)	0.25 (0.010)	0.95 (0.040)	0.20 (0.008)	—	A12
miniASMDC014F	4.37 (0.172)	4.73 (0.186)	0.635 (0.025)	0.89 (0.035)	3.07 (0.121)	3.41 (0.134)	0.25 (0.010)	0.95 (0.040)	0.20 (0.008)	—	A12
miniASMDC020F	4.37 (0.172)	4.73 (0.186)	0.635 (0.025)	0.89 (0.035)	3.07 (0.121)	3.41 (0.134)	0.25 (0.010)	0.95 (0.040)	0.20 (0.008)	—	A12
miniASMDC030F	4.37 (0.172)	4.73 (0.186)	0.635 (0.025)	0.89 (0.035)	3.07 (0.121)	3.41 (0.134)	0.25 (0.010)	0.95 (0.040)	0.20 (0.008)	—	A12
miniASMDC050F	4.37 (0.172)	4.73 (0.186)	0.38 (0.015)	0.62 (0.025)	3.07 (0.121)	3.41 (0.134)	0.25 (0.010)	0.95 (0.040)	0.20 (0.008)	—	A12
miniASMDC075F	4.37 (0.172)	4.73 (0.186)	0.38 (0.015)	0.62 (0.025)	3.07 (0.121)	3.41 (0.134)	0.25 (0.010)	0.95 (0.040)	0.20 (0.008)	—	A12
miniASMDC075F/24	4.37 (0.172)	4.83 (0.190)	0.81 (0.032)	1.46 (0.057)	3.07 (0.121)	3.41 (0.134)	0.25 (0.010)	0.95 (0.040)	0.20 (0.008)	—	A12
miniASMDC075F/33	4.37 (0.172)	4.73 (0.190)	0.94 (0.037)	1.46 (0.057)	3.07 (0.121)	3.41 (0.134)	0.25 (0.010)	0.95 (0.040)	0.20 (0.008)	—	A12
miniASMDC110F/16	4.37 (0.172)	4.83 (0.190)	0.28 (0.011)	0.48 (0.019)	3.07 (0.121)	3.41 (0.134)	0.25 (0.010)	0.95 (0.040)	0.20 (0.008)	—	A12
miniASMDC110F/24	4.37 (0.172)	4.83 (0.190)	0.81 (0.032)	1.46 (0.057)	3.07 (0.121)	3.41 (0.134)	0.25 (0.010)	0.95 (0.040)	0.20 (0.008)	—	A12
miniASMDC125F/16	4.37 (0.172)	4.83 (0.190)	0.28 (0.011)	0.48 (0.019)	3.07 (0.121)	3.41 (0.134)	0.25 (0.010)	0.95 (0.040)	0.20 (0.008)	—	A12
miniASMDC150F/12	4.37 (0.172)	4.83 (0.190)	0.28 (0.011)	0.48 (0.019)	3.07 (0.121)	3.41 (0.134)	0.25 (0.010)	0.95 (0.040)	0.20 (0.008)	—	A12

# PolySwitch Resettable Devices

## Automotive Devices

Table A4 – Dimensions in Millimeters and (Inches)

(Cont'd)

Part Number	A		B		C		D		E		Figure
	Min	Max	Min	Max	Min	Max	Min	Max	Min	Max	
<b>miniASMDC</b>											
<b>12-60V – Surface-mount</b>											
miniASMDC150F/16	4.37 (0.172)	4.83 (0.190)	0.28 (0.011)	0.48 (0.019)	3.07 (0.121)	3.41 (0.134)	0.25 (0.010)	0.95 (0.040)	0.20 (0.008)	—	A12
miniASMDC150F/24	4.37 (0.172)	4.83 (0.190)	1.00 (0.040)	1.94 (0.077)	3.07 (0.121)	3.41 (0.134)	0.25 (0.010)	0.95 (0.040)	0.20 (0.008)	—	A12
miniASMDC200F/16	4.37 (0.172)	4.73 (0.186)	0.51 (0.020)	1.22 (0.048)	3.07 (0.121)	3.41 (0.134)	0.25 (0.010)	0.95 (0.040)	0.20 (0.008)	—	A12
miniASMDC260F/12	4.37 (0.172)	4.83 (0.190)	1.02 (0.042)	1.52 (0.060)	3.07 (0.121)	3.41 (0.134)	0.25 (0.010)	0.95 (0.040)	0.20 (0.008)	—	A12
miniASMDC260F/13.2	4.37 (0.172)	4.83 (0.190)	1.02 (0.042)	1.52 (0.060)	3.07 (0.121)	3.41 (0.134)	0.25 (0.010)	0.95 (0.040)	0.20 (0.008)	—	A12
miniASMDC260F/16	4.37 (0.172)	4.83 (0.190)	1.02 (0.042)	1.52 (0.060)	3.07 (0.121)	3.41 (0.134)	0.25 (0.010)	0.95 (0.040)	0.20 (0.008)	—	A12
<b>ASMDC</b>											
<b>24-60V – Surface-mount</b>											
ASMDC030F	7.30 (0.287)	7.70 (0.303)	0.63 (0.025)	0.90 (0.035)	4.90 (0.193)	5.30 (0.209)	0.25 (0.010)	0.95 (0.040)	0.20 (0.008)	—	A12
ASMDC050F	7.30 (0.287)	7.70 (0.303)	0.63 (0.025)	0.90 (0.035)	4.90 (0.193)	5.30 (0.209)	0.25 (0.010)	0.95 (0.040)	0.20 (0.008)	—	A12
ASMDC075F	7.30 (0.287)	7.70 (0.303)	0.63 (0.025)	0.90 (0.035)	4.90 (0.193)	5.30 (0.209)	0.25 (0.010)	0.95 (0.040)	0.20 (0.008)	—	A12
ASMDC125F/33	7.30 (0.287)	7.70 (0.303)	0.45 (0.018)	0.71 (0.028)	4.90 (0.193)	5.30 (0.209)	0.25 (0.010)	0.95 (0.040)	0.20 (0.008)	—	A12
ASMDC185F/33	7.30 (0.287)	7.70 (0.303)	0.90 (0.035)	1.20 (0.047)	4.90 (0.193)	5.30 (0.209)	0.25 (0.010)	0.95 (0.040)	0.20 (0.008)	—	A12
ASMDC300F/24	7.30 (0.287)	7.70 (0.303)	0.80 (0.031)	1.10 (0.043)	4.90 (0.193)	5.30 (0.209)	0.25 (0.010)	0.95 (0.040)	0.20 (0.008)	—	A12



# PolySwitch Resettable Devices

## Automotive Devices

### Figures A13-A23 – Typical Time-to-trip at 25°C for PolySwitch Automotive Devices

#### AGRF

- A = AGRF400
- B = AGRF500
- C = AGRF600
- D = AGRF700
- E = AGRF800
- F = AGRF900
- G = AGRF1000
- H = AGRF1100
- I = AGRF1200
- J = AGRF1400



#### AHRF

- A = AHRF050
- B = AHRF070
- C = AHRF100
- D = AHRF200
- E = AHRF300
- F = AHRF400
- G = AHRF450
- H = AHRF550
- I = AHRF600
- J = AHRF650
- K = AHRF700
- L = AHRF750
- M = AHRF800
- N = AHRF900
- O = AHRF1000
- P = AHRF1100
- Q = AHRF1300
- R = AHRF1400
- S = AHRF1500



#### AHEF

- A = AHEF050
- B = AHEF070
- C = AHEF100
- D = AHEF300
- E = AHEF500
- F = AHEF750
- G = AHEF1000



# PolySwitch Resettable Devices

## Automotive Devices

### Figures A13-A23 – Typical Time-to-trip at 25°C for PolySwitch Automotive Devices (Cont'd)

#### AHS

- A = AHS080-2018
- B = AHS120
- C = AHS160
- D = AHS200
- E = AHS300

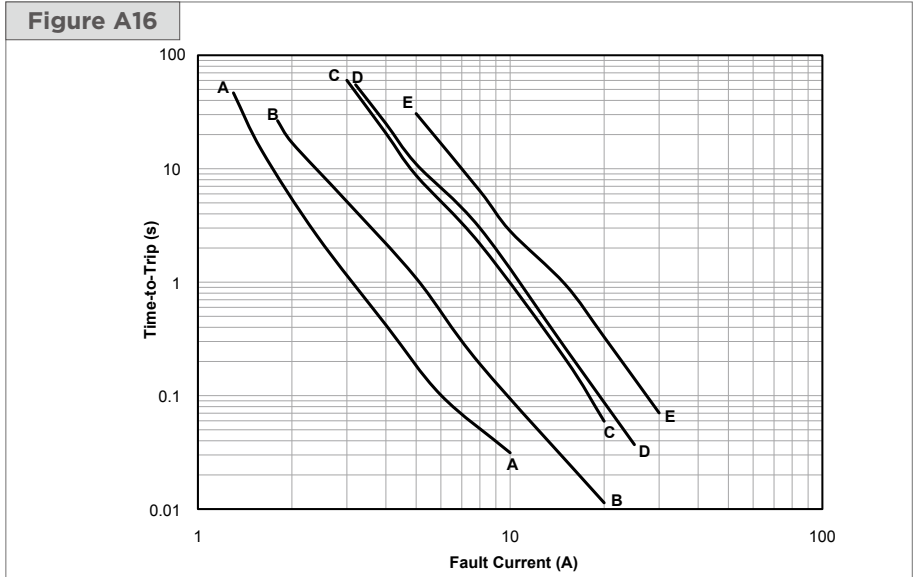

#### ASMD

- A = ASMD030F
- B = ASMD050F
- C = ASMD075F
- D = ASMD100F
- E = ASMD125F
- F = ASMD150F, ASMD150F/33
- G = ASMD185F
- H = ASMD200F
- I = ASMD250F

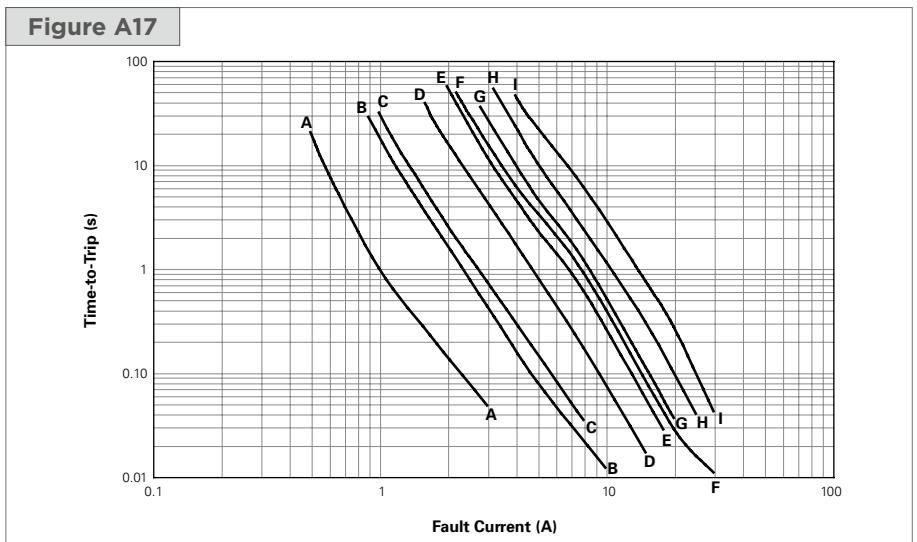

#### femtoASMDC

- A = femtoASMDC005F
- B = femtoASMDC008F
- C = femtoASMDC010F/15

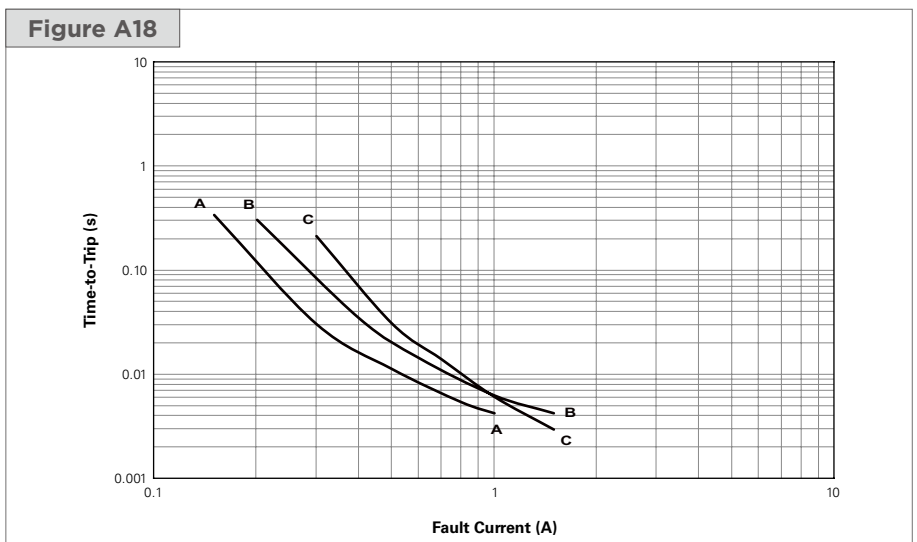

# PolySwitch Resettable Devices

## Automotive Devices

### Figures A13-A23 – Typical Time-to-trip at 25°C for PolySwitch Automotive Devices (Cont'd)

#### picoASMD

- A = picoASMD010S
- B = picoASMD020S

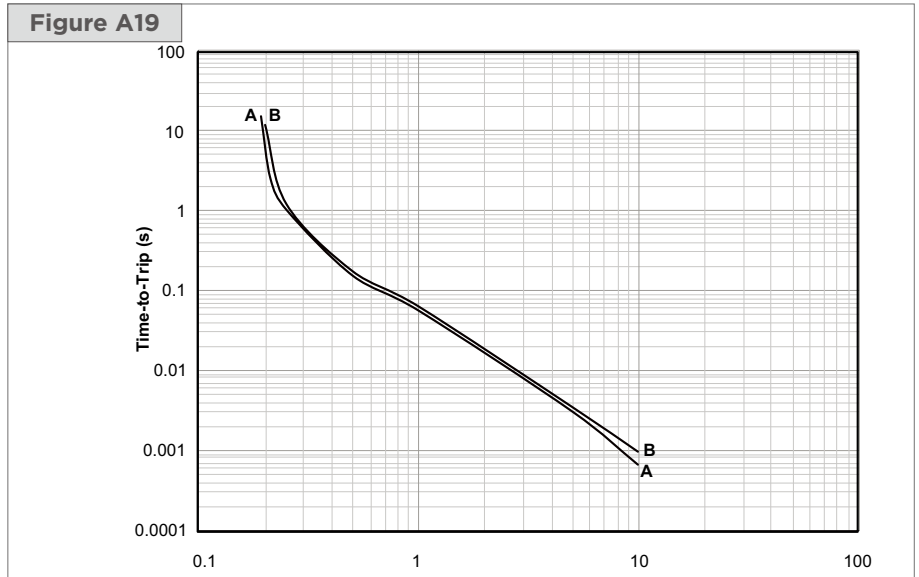

#### nanoASMD

- A = nanoASMD010F
- B = nanoASMD012F
- C = nanoASMD016F
- D = nanoASMD020F
- E = nanoASMD025F
- F = nanoASMD035F
- G = nanoASMD050F/13.2

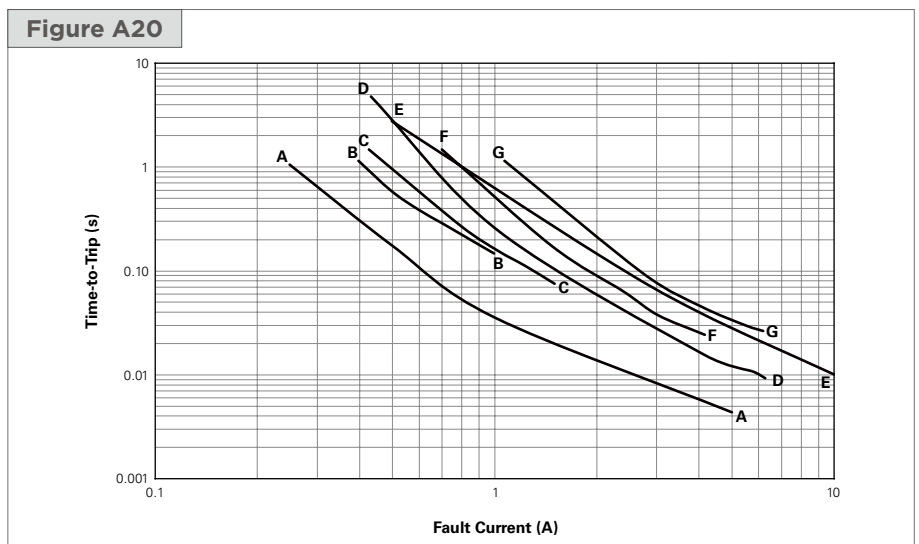

#### microASMD

- A = microASMD005F
- B = microASMD010F
- C = microASMD050F

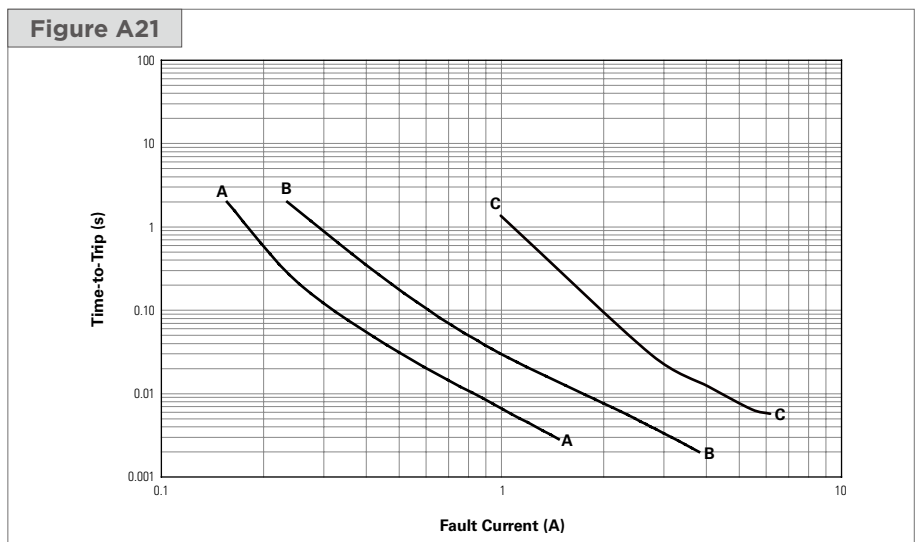

# PolySwitch Resettable Devices

## Automotive Devices

### Figures A13-A23 – Typical Time-to-trip at 25°C for PolySwitch Automotive Devices (Cont'd)

#### miniASMDC

- A = miniASMDC010F, miniASMDC014F
- B = miniASMDC020F
- C = miniASMDC030F
- D = miniASMDC050F
- E = miniASMDC075F
- F = miniASMDC075F/24
- G = miniASMDC075F/33
- H = miniASMDC110F/16
- I = miniASMDC110F/24
- J = miniASMDC125F/16
- K = miniASMDC150F/12
- L = miniASMDC150F/16
- M = miniASMDC150F/24
- N = miniASMDC200F/16
- O = miniASMDC260F/12, miniASMDC260F/13.2, miniASMDC260F/16

**Figure A22**

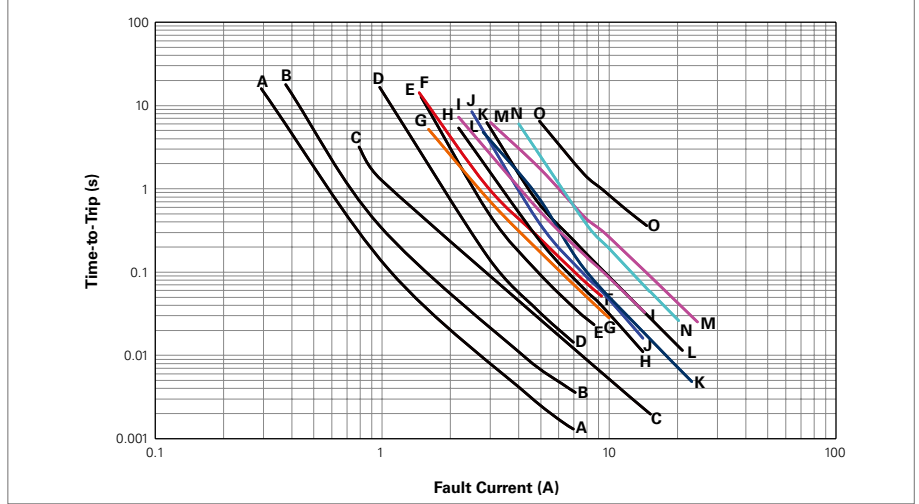

#### ASMDC

- A = ASMDC030F
- B = ASMDC050F
- C = ASMDC075F
- D = ASMDC125F/33
- E = ASMDC185F/33
- F = ASMDC300F/24

**Figure A23**

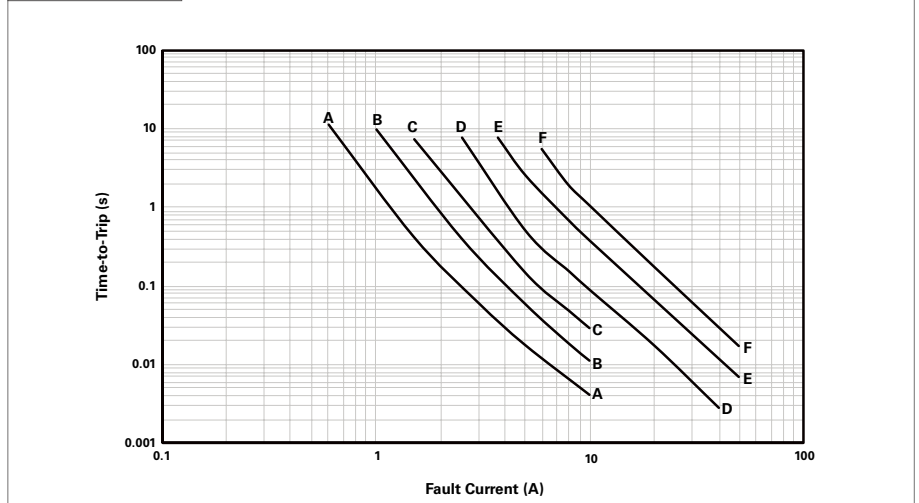

## PolySwitch Resettable Devices

### Automotive Devices

Figures A24 — Recommended Pad Layout for PolySwitch Automotive Devices



Table A5 - Physical Characteristics and Environmental Specifications for Automotive Devices

AGRF		
Physical Characteristics		
Lead Material	AGRF400 to AGRF1100 : Tin-plated Copper, 0.52mm <sup>2</sup> (20AWG) $\phi$ 0.8 mm/0.032in AGRF1200 to AGRF1400: Tin-plated Copper, 0.82mm <sup>2</sup> (18AWG) $\phi$ 1.0mm/0.040in	
Soldering Characteristics	Solderability per ANSI/J-STD-002 Category 3	
Solder Heat Withstand	AGRF400 : per IEC68-2-20 Test Tb, Method 1A, Condition A: Can Withstand 5 s at 260°C $\pm$ 5°C AGRF500-AGRF1400 : per IEC68-2-20 Test Tb, Method 1A, Condition B: Can Withstand 10 s at 260°C $\pm$ 5°C	
Insulating Material	Cured, Flame-retardant Epoxy Polymer; Meets UL 94V-0	
Operation Temperature	-40°C~85°C	
<b>Note:</b> See PS400 for other physical characteristics. Devices are not intended to be placed through a reflow process.		
Environmental Specifications		
Test	Conditions	Resistance Change
Passive Aging	70°C, 1000 hrs	$\pm$ 5%
	85°C, 1000 hrs	$\pm$ 5%
Humidity Aging	85°C, 85% RH, 1000 hrs	$\pm$ 5%
Thermal Shock	85°C, -40°C (10 Times)	$\pm$ 5%
Solvent Resistance	MIL-STD-202, Method 215F	No Change
<b>Note:</b> See PS400 for other environmental specifications.		

# PolySwitch Resettable Devices

## Automotive Devices

### Table A5 – Physical Characteristics and Environmental Specifications

(Cont'd)

<b>AHRF</b>	
<b>Physical Characteristics</b>	
Lead material	AHRF050 to AHRF200 : Tin-plated Copper-clad Steel, 0.205mm <sup>2</sup> (24 AWG), ø 0.51mm/0.020in AHRF300 to AHRF1100 : Tin-plated Copper 0.52mm <sup>2</sup> (20 AWG), ø 0.81mm/0.032in AHRF1300 to AHRF1500: Tin-plated Copper 0.82mm <sup>2</sup> (18 AWG), ø 1.0mm/0.04in
Soldering Characteristics	Solderability per ANSI/J-STD 002 Category 3
Solder Heat Withstand	Per IEC 68-2-20, Test Tb, Method 1A, Condition B; Can Withstand 10 s at 260°C ± 5°C
Insulating Material	Cured, Flame-retardant Epoxy Polymer; Meets UL 94V-0 Requirements
Operation Temperature	-40°C~125°C

**Note:** See PS400 for other physical characteristics.  
Devices are not intended to be placed through a reflow process.

<b>Environmental Specifications</b>		
<b>Test</b>	<b>Conditions</b>	<b>Resistance Change</b>
Passive Aging	70°C, 1000 hrs	±5%
	85°C, 1000 hrs	±5%
Humidity Aging	85°C, 85% RH, 1000 hrs	±5%
Thermal Shock	125°C, -40°C (10 Times)	±5%
Solvent Resistance	MIL-STD-202, Method 215F	No Change

**Note:** See PS400 for other environmental specifications.

<b>AHEF</b>	
<b>Physical Characteristics</b>	
Lead Material	AHEF050 to AHEF100: Tin-plated Copper-clad Steel, 0.205mm <sup>2</sup> (24 AWG), ø 0.51mm/0.020in. AHEF300 to AHEF750: Tin-plated Copper 0.52mm <sup>2</sup> (20 AWG), ø 0.81mm/0.032in AHEF1000: Tin-plated Copper 0.82mm <sup>2</sup> (18 AWG), ø 1.0mm/0.04in
Soldering Characteristics	Solderability per ANSI/J-STD 002 Category 3
Solder Heat Withstand	Per IEC 68-2-20, Test Tb, Method 1A, Condition B; Can Withstand 10 s at 260°C ± 5°C
Insulating Material	Cured, Flame-retardant Epoxy Polymer; Meets UL 94V-0 Requirements
Operation Temperature	-40°C~125°C

**Note:** See PS400 for other physical characteristics.  
Devices are not intended to be placed through a reflow process.

<b>Environmental Specifications</b>		
<b>Test</b>	<b>Conditions</b>	<b>Resistance Change</b>
Passive Aging	70°C, 1000 hrs	±5%
	85°C, 1000 hrs	±5%
Humidity Aging	85°C, 85% RH, 1000 hrs	±5%
Thermal Shock	125°C, -40°C (10 Times)	±5%
Solvent Resistance	MIL-STD-202, Method 215F	No Change

**Note:** See PS400 for other environmental specifications.

# PolySwitch Resettable Devices

## Automotive Devices

Table A5 – Physical Characteristics and Environmental Specifications

(Cont'd)

AHS	
Physical Characteristics	
Lead Material	Tin-plated Brass to MIL-T-10727B
Soldering Characteristics	Solderability per ANSI-J-STD-002 Category 1
Solder Heat Withstand	Per IEC-STD 68-2-20, Test Tb, Section 5, Method 1A
Flammability	Per IEC 695-2-2 Needle Flame Test for 20 s
Operation Temperature	-40°C~125°C

**Note:** See PS400 for other physical characteristics.

Environmental Specifications		
Test	Conditions	Resistance Change
Passive Aging	70°C, 1000 hrs	±3% Typical
	85°C, 1000 hrs	±5% Typical
Humidity Aging	85°C, 85% RH, 1000 hrs	±1.2% Typical
Thermal Shock	125°C, -40°C (20 Times)	-33% Typical
Solvent Resistance	Freon	No Change
	Trichloroethane	No Change
	Hydrocarbons	No Change

**Note:** See PS400 for other environmental specifications.

ASMD	
Physical Characteristics	
Terminal Pad Material	98%+ Tin-plated Brass
Soldering Characteristics	Solderability per ANSI-J-STD-002 Category 1
Solder Heat Withstand	Per IEC-STD 68-2-20, Test Tb, Section 5, Method 1A
Flammability Resistance	Per IEC 695-2-2 Needle Flame Test for 20 s
Recommended Storage Conditions	40°C max, 70% RH max; Devices May Not Meet Specified Ratings if Storage Conditions are Exceeded
Operation Temperature	-40°C~85°C

**Note:** See PS400 for other physical characteristics.

Environmental Specifications		
Test	Conditions	Resistance Change
Passive Aging	60°C, 1000 hrs	±3% Typical
	85°C, 1000 hrs	±5% Typical
Humidity Aging	85°C, 85% RH, 100 hrs	±1.2% Typical
Thermal Shock	85°C, -40°C (20 Times)	-33% Typical
	125°C, -55°C (10 Times)	-33% Typical
Solvent Resistance	Freon	No Change
	Trichloroethane	No Change
	Hydrocarbons	No Change

**Note:** See PS400 for other environmental specifications.

# PolySwitch Resettable Devices

## Automotive Devices

### Table A5 – Physical Characteristics and Environmental Specifications

(Cont'd)

femtoASMDC/picoASMDC/nanoASMDC/microASMD/miniASMDC/ASMDC		
Physical Characteristics		
Terminal Pad Material	100% Matte Tin with Nickel Underplate	
Soldering Characteristics	Solderability per ANSI-J-STD-002 Category 3	
Solder Heat Withstand	Per IEC-STD 68-2-20, Test Tb, Section 5, Method 1A	
Flammability Resistance	Per IEC 695-2-2 Needle Flame Test for 20 s	
Recommended Storage Conditions	40°C max, 70% RH max; Devices May Not Meet Specified Ratings if Storage Conditions are Exceeded	
Operation Temperature	-40°C~85°C	
<b>Note:</b> See PS400 for other physical characteristics.		
Environmental Specifications		
Test	Conditions	Resistance Change
Passive Aging	60°C, 1000 hrs	±3% Typical
	85°C, 1000 hrs	±5% Typical
Humidity Aging	85°C, 85% RH, 100 hrs	±1.2% Typical
Thermal Shock	85°C, -40°C (20 Times)	-33% Typical
	125°C, -55°C (10 Times)	-33% Typical
Solvent Resistance	Freon	No Change
	Trichloroethane	No Change
	Hydrocarbons	No Change
<b>Note:</b> See PS400 for other environmental specifications.		



# PolySwitch Resettable Devices

## Automotive Devices

### Table A6 – Packaging and Marking Information for Automotive Devices

Part Number	Bag Quantity	Tape and Reel Quantity	Ammo Pack Quantity	Standard Package Quantity	Part Marking	Agency Recognition
<b>AGRF</b>						
<b>Radial-leaded</b>						
AGRF400	500	—	—	10,000	G4	*
AGRF400-2	—	2,500	—	12,500	G4	*
AGRF400-AP	—	—	2,000	10,000	G4	*
AGRF500	500	—	—	10,000	G5	*
AGRF500-2	—	2,000	—	10,000	G5	*
AGRF500-AP	—	—	2,000	10,000	G5	*
AGRF600	500	—	—	10,000	G6	*
AGRF600-2	—	2,000	—	10,000	G6	*
AGRF600-AP	—	—	2,000	10,000	G6	*
AGRF700	500	—	—	10,000	G7	*
AGRF700-2	—	1,500	—	7,500	G7	*
AGRF700-AP	—	—	1,500	7,500	G7	*
AGRF800	500	—	—	10,000	G8	*
AGRF800-2	—	1,500	—	7,500	G8	*
AGRF800-AP	—	—	1,500	7,500	G8	*
AGRF900	500	—	—	10,000	G9	*
AGRF900-2	—	1,000	—	5,000	G9	*
AGRF900-AP	—	—	1,000	5,000	G9	*
AGRF1000	250	—	—	5,000	G10	*
AGRF1000-2	—	1,000	—	5,000	G10	*
AGRF1000-AP	—	—	1,000	5,000	G10	*
AGRF1100	250	—	—	5,000	G11	*
AGRF1100-2	—	1,000	—	5,000	G11	*
AGRF1100-AP	—	—	1,000	5,000	G11	*
AGRF1200	250	—	—	5,000	G12	*
AGRF1200-2	—	1,000	—	5,000	G12	*
AGRF1200-AP	—	—	1,000	5,000	G12	*
AGRF1400	250	—	—	5,000	G14	*
AGRF1400-2	—	1,000	—	5,000	G14	*
AGRF1400-AP	—	—	1,000	5,000	G14	*
<b>AHRF (High Temperature)</b>						
<b>Radial-leaded</b>						
AHRF050	500	—	—	10,000	H0.5	*
AHRF050-2	—	2,500	—	12,500	H0.5	*
AHRF050-AP	—	—	2,500	12,500	H0.5	*
AHRF070	500	—	—	10,000	H0.7	*
AHRF070-2	—	2,500	—	12,500	H0.7	*
AHRF070-AP	—	—	2,500	12,500	H0.7	*
AHRF100	500	—	—	10,000	H1	*
AHRF100-2	—	2,500	—	12,500	H1	*
AHRF100-AP	—	—	2,500	12,500	H1	*
AHRF200	500	—	—	10,000	H2	*
AHRF200-2	—	2,500	—	12,500	H2	*
AHRF200-AP	—	—	2,500	12,500	H2	*
AHRF300	500	—	—	10,000	H3	*
AHRF300-2	—	2,000	—	10,000	H3	*
AHRF300-AP	—	—	2,000	10,000	H3	*
AHRF400	500	—	—	10,000	H4	*
AHRF400-2	—	1,500	—	7,500	H4	*
AHRF400-AP	—	—	1,500	7,500	H4	*

\* These devices are intended for use in automotive applications.  
For commercial alternatives to these products please refer to radial-leaded devices or surface-mount devices product brochures.

# PolySwitch Resettable Devices

## Automotive Devices

Table A6 — Packaging and Marking Information for Automotive Devices  
(Cont'd)

Part Number	Bag Quantity	Tape and Reel Quantity	Ammo Pack Quantity	Standard Package Quantity	Part Marking	Agency Recognition
<b>AHRF (High Temperature)</b>						
<b>Radial-leaded</b>						
AHRF450	500	—	—	10,000	H4.5	*
AHRF450-2	—	1,500	—	7,500	H4.5	*
AHRF450-AP	—	—	1,500	7,500	H4.5	*
AHRF550	500	—	—	10,000	H5.5	*
AHRF550-2	—	2,000	—	10,000	H5.5	*
AHRF550-AP	—	—	2,000	10,000	H5.5	*
AHRF600	500	—	—	10,000	H6	*
AHRF600-2	—	2,000	—	10,000	H6	*
AHRF600-AP	—	—	2,000	10,000	H6	*
AHRF650	500	—	—	10,000	H6.5	*
AHRF650-2	—	1,500	—	7,500	H6.5	*
AHRF650-AP	—	—	1,500	7,500	H6.5	*
AHRF700	500	—	—	10,000	H7	*
AHRF700-2	—	1,500	—	7,500	H7	*
AHRF700-AP	—	—	1,500	7,500	H7	*
AHRF750	500	—	—	10,000	H7.5	*
AHRF750-2	—	1,000	—	5,000	H7.5	*
AHRF750-AP	—	—	1,000	5,000	H7.5	*
AHRF800	500	—	—	10,000	H8	*
AHRF800-2	—	1,000	—	5,000	H8	*
AHRF800-AP	—	—	1,000	5,000	H8	*
AHRF900	250	—	—	5,000	H9	*
AHRF900-2	—	1,000	—	5,000	H9	*
AHRF900-AP	—	—	1,000	5,000	H9	*
AHRF1000	250	—	—	5,000	H10	*
AHRF1000-2	—	1,000	—	5,000	H10	*
AHRF1000-AP	—	—	1,000	5,000	H10	*
AHRF1100	250	—	—	5,000	H11	*
AHRF1100-2	—	1,000	—	5,000	H11	*
AHRF1100-AP	—	—	1,000	5,000	H11	*
AHRF1300	250	—	—	5,000	H13	*
AHRF1300-2	—	1,000	—	5,000	H13	*
AHRF1300-AP	—	—	1,000	5,000	H13	*
AHRF1400	250	—	—	5,000	H14	*
AHRF1400-2	—	1,000	—	5,000	H14	*
AHRF1400-AP	—	—	1,000	5,000	H14	*
AHRF1500	250	—	—	5,000	H15	*
AHRF1500-2	—	1,000	—	5,000	H15	*
AHRF1500-AP	—	—	1,000	5,000	H15	*
<b>AHEF (High Temperature)</b>						
<b>Radial-leaded</b>						
AHEF050	500	—	—	10,000	E0.5	*
AHEF070	500	—	—	10,000	E0.7	*
AHEF100	500	—	—	10,000	E1	*
AHEF300	500	—	—	10,000	E3	*
AHEF500	250	—	—	5,000	E5	*
AHEF750	250	—	—	5,000	E7.5	*
AHEF1000	250	—	—	5,000	E10	*

\* These devices are intended for use in automotive applications.  
For commercial alternatives to these products please refer to the radial-leaded devices or surface-mount devices product brochures.

# PolySwitch Resettable Devices

## Automotive Devices

Table A6 — Packaging and Marking Information for Automotive Devices  
(Cont'd)

Part Number	Tape and Reel Quantity	Standard Package Quantity	Part Marking	Recommended Pad Layouts [mm(in) See Figure A24]			Agency Recognition
				Dimension A (Min*/Nom)	Dimension B (Nom)	Dimension C (Nom)	
<b>AHS (High Temperature)</b>							
<b>Surface-mount</b>							
AHS080-2018	4,000	20,000	H08	4.6 (0.18)	1.5 (0.06)	3.4 (0.134)	*
AHS120	2,000	10,000	H12	3.1 (0.12)	2.3 (0.09)	5.1 (0.201)	*
AHS160	1,500	7,500	160	4.6 (0.18)	2.3 (0.09)	6.1 (0.240)	*
AHS200	1,500	7,500	H200	4.6 (0.18)	2.3 (0.09)	6.1 (0.240)	*
AHS300	1,500	7,500	H300	4.6 (0.18)	2.3 (0.09)	6.1 (0.240)	*
<b>ASMD</b>							
<b>Surface-mount</b>							
ASMD030F	2,000	10,000	030F	3.1 (0.12)	2.3 (0.09)	5.1 (0.201)	*
ASMD050F	2,000	10,000	050F	3.1 (0.12)	2.3 (0.09)	5.1 (0.201)	*
ASMD075F	2,000	10,000	075F	3.1 (0.12)	2.3 (0.09)	5.1 (0.201)	*
ASMD100F	2,000	10,000	100F	3.1 (0.12)	2.3 (0.09)	5.1 (0.201)	*
ASMD125F	2,000	10,000	125F	3.1 (0.12)	2.3 (0.09)	5.1 (0.201)	*
ASMD150F	1,500	7,500	150F	4.6 (0.18)	2.3 (0.09)	6.1 (0.240)	*
ASMD150F/33	1,500	7,500	153F	4.6 (0.18)	2.3 (0.09)	6.1 (0.240)	*
ASMD185F	1,500	7,500	185A	4.6 (0.18)	2.3 (0.09)	6.1 (0.240)	*
ASMD200F	1,500	7,500	200F	4.6 (0.18)	2.3 (0.09)	6.1 (0.240)	*
ASMD250F	1,500	7,500	250F	4.6 (0.18)	2.3 (0.09)	6.1 (0.240)	*
<b>femtoASMD</b>							
<b>Surface-mount</b>							
femtoASMD005F	4,000	20,000	A	0.80 (0.032)	0.60 (0.024)	0.80 (0.032)	*
femtoASMD008F	4,000	20,000	T	0.80 (0.032)	0.60 (0.024)	0.80 (0.032)	*
femtoASMD010F/15	4,000	20,000	B	0.80 (0.032)	0.60 (0.024)	0.80 (0.032)	*
<b>picoASMD</b>							
<b>Surface-mount</b>							
picoASMD010S	3,000	15,000	C	1.50 (0.060)	1.00 (0.039)	1.20 (0.047)	*
picoASMD012S	4,000	20,000	F	1.50 (0.060)	1.00 (0.039)	1.20 (0.047)	*
<b>nanoASMD</b>							
<b>Surface-mount</b>							
nanoASMD010F	3,000	15,000	A	1.60 (0.063)	1.00 (0.039)	2.00 (0.079)	*
nanoASMD012F	3,000	15,000	P	1.60 (0.063)	1.00 (0.039)	2.00 (0.079)	*
nanoASMD016F	3,000	15,000	N	1.60 (0.063)	1.00 (0.039)	2.00 (0.079)	*
nanoASMD020F	3,000	15,000	02	1.60 (0.063)	1.00 (0.039)	2.00 (0.079)	*
nanoASMD025F	3,000	15,000	C	1.60 (0.063)	1.00 (0.039)	2.00 (0.079)	*
nanoASMD035F	3,000	15,000	03	1.60 (0.063)	1.00 (0.039)	2.00 (0.079)	*
nanoASMD050F/13.2	3,000	15,000	M	1.60 (0.063)	1.00 (0.039)	2.00 (0.079)	*
<b>microASMD</b>							
<b>Surface-mount</b>							
microASMD005F	4,000	20,000	05	2.50 (0.098)	1.00 (0.039)	2.00 (0.079)	*
microASMD010F	4,000	20,000	10	2.50 (0.098)	1.00 (0.039)	2.00 (0.079)	*
microASMD050F	4,000	20,000	50	2.50 (0.098)	1.00 (0.039)	2.00 (0.079)	*
<b>miniASMD</b>							
<b>Surface-mount</b>							
miniASMD010F	2,000	10,000	10	3.15 (0.124)	1.68 (0.066)	3.10 (0.122)	*
miniASMD014F	2,000	10,000	14	3.15 (0.124)	1.68 (0.066)	3.10 (0.122)	*
miniASMD020F	2,000	10,000	2	3.15 (0.124)	1.68 (0.066)	3.10 (0.122)	*
miniASMD030F	2,000	10,000	3	3.15 (0.124)	1.68 (0.066)	3.10 (0.122)	*
miniASMD050F	2,000	10,000	5	3.15 (0.124)	1.68 (0.066)	3.10 (0.122)	*
miniASMD075F	2,000	10,000	7	3.15 (0.124)	1.68 (0.066)	3.10 (0.122)	*
miniASMD075F/24	1,500	7,500	075F 24V	3.15 (0.124)	1.68 (0.066)	3.10 (0.122)	*
miniASMD075F/33	1,500	7,500	075F 33V	3.15 (0.124)	1.68 (0.066)	3.10 (0.122)	*
miniASMD110F/16	2,000	10,000	110F 16V	3.15 (0.124)	1.68 (0.066)	3.10 (0.122)	*
miniASMD110F/24	1,500	7,500	110F 24V	3.15 (0.124)	1.68 (0.066)	3.10 (0.122)	*
miniASMD125F/16	2,000	10,000	125F 16V	3.15 (0.124)	1.68 (0.066)	3.10 (0.122)	*
miniASMD150F/12	2,000	10,000	150F 12V	3.15 (0.124)	1.68 (0.066)	3.10 (0.122)	*

\* These devices are intended for use in automotive applications.

For commercial alternatives to these products please refer to the radial-leaded devices or surface-mount devices product brochures.

## PolySwitch Resettable Devices

### Automotive Devices

Table A6 — Packaging and Marking Information for Automotive Devices  
(Cont'd)

Part Number	Tape and Reel Quantity	Standard Package Quantity	Part Marking	Recommended Pad Layouts [mm(in) See Figure A24]			Agency Recognition
				Dimension A (Min*/Nom)	Dimension B (Nom)	Dimension C (Nom)	
<b>miniASMDC</b>							
<b>Surface-mount</b>							
miniASMDC150F/16	2,000	10,000	150 16V	3.15 (0.124)	1.68 (0.066)	3.10 (0.122)	*
miniASMDC150F/24	1,000	5,000	150F 24V	3.15 (0.124)	1.68 (0.066)	3.10 (0.122)	*
miniASMDC200F/16	2,000	10,000	200F 16V	3.15 (0.124)	1.68 (0.066)	3.10 (0.122)	*
miniASMDC260F/12	1,500	7,500	260F 12V	3.15 (0.124)	1.68 (0.066)	3.10 (0.122)	*
miniASMDC260F/13.2	1,500	7,500	260F 13V	3.15 (0.124)	1.68 (0.066)	3.10 (0.122)	*
miniASMDC260F/16	1,500	7,500	260F 16V	3.15 (0.124)	1.68 (0.066)	3.10 (0.122)	*
<b>ASMDC</b>							
<b>Surface-mount</b>							
ASMDC030F	4,000	20,000	030F	5.30 (0.209)	2.00 (0.079)	4.60 (0.18)	*
ASMDC050F	4,000	20,000	050F	5.30 (0.209)	2.00 (0.079)	4.60 (0.18)	*
ASMDC075F	4,000	20,000	075F	5.30 (0.209)	2.00 (0.079)	4.60 (0.18)	*
ASMDC125F/33	4,000	20,000	125F	5.30 (0.209)	2.00 (0.079)	4.60 (0.18)	*
ASMDC185F/33	4,000	20,000	185F 33V	5.30 (0.209)	2.00 (0.079)	4.60 (0.18)	*
ASMDC300F/24	4,000	20,000	300F 24V	5.30 (0.209)	2.00 (0.079)	4.60 (0.18)	*

\* These devices are intended for use in automotive applications.  
For commercial alternatives to these products please refer to the radial-leaded devices or surface-mount devices product brochures.

# PolySwitch Resettable Devices

## Automotive Devices

### Table A7 — Tape and Reel Specifications for AGRF/AHRF/AHEF Automotive Devices

AGRF, AHRF and AHEF devices are available in tape and reel packaging per EIA468-B/IEC286-2 and EIA 481-2 standards. See Figures A25 and A26 for details

Description	EIA Mark	Dimension (mm)	Tolerance
Carrier Tape Width	W	18.0	-0.5/+1.0
Hold Down Tape Width	W <sub>4</sub>	11.0	Minimum
Top Distance between Tape Edges	W <sub>6</sub>	3.0	Maximum
Sprocket Hole Position	W <sub>5</sub>	9.0	-0.5/+0.75
Sprocket Hole Diameter	D <sub>0</sub>	4.0	±0.2
Abscissa to Plane (Straight Lead) (AHEF300 to AHEF1000)	H	20.3	±0.5
Abscissa to Plane (Kinked Lead) (AGRF400 to AGRF1400, AHRF050 to AHRF1500, AHEF050 to AHEF100)	H <sub>0</sub>	16.0	±0.5
Abscissa to Top (AGRF400 to AGRF600, AHRF050 to AHRF450, AHEF050 to AHEF300)	H <sub>1</sub>	32.2	Maximum
Abscissa to Top (AGRF700 to AGRF1400, AHRF550 to AHRF1500*, AHEF500 to AHEF1000)	H <sub>1</sub>	45.0	Maximum
Overall Width with Lead Protrusion (AGRF400 to AGRF600 & AHRF050 to AHRF450, AHEF050 to AHEF300)	C <sub>1</sub>	43.2	Maximum
Overall Width with Lead Protrusion (AGRF700 to AGRF1400, AHRF550 to AHRF1500, AHEF500 to AHEF1000)	C <sub>1</sub>	55.0	Maximum
Overall Width without Lead Protrusion (AGRF400 to AGRF600, AHRF050 to AHRF450, AHEF050 to AHEF300)	C <sub>2</sub>	42.5	Maximum
Overall Width without Lead Protrusion (AGRF700 to AGRF1400, AHRF550 to AHRF1500, AHEF500 to AHEF1000)	C <sub>2</sub>	54.0	Maximum
Lead Protrusion	L <sub>1</sub>	1.0	Maximum
Protrusion of Cut-out	L	11.0	Maximum
Protrusion Beyond Hold-Down Tape	l <sub>2</sub>	Not specified	—
Sprocket Hole Pitch	P <sub>0</sub>	12.7	± 0.3
Device Pitch (AGRF400 to AGRF700, AHRF050 to AHRF600, AHEF050 to AHEF300)	—	12.7	± 0.3
Device Pitch (AGRF800 to AGRF1400, AHRF650 to AHRF1500, AHEF500 to AHEF1000)	—	25.4	± 0.6
Pitch Tolerance	—	20 consec.	± 0.1
Tape Thickness	t	0.9	Maximum
Overall Tape and Lead Thickness (AGRF400 to AGRF1100, AHRF050 to AHRF1100*, AHEF050 to AHEF750)	t <sub>1</sub>	2.0	Maximum
Overall Tape and Lead Thickness (AGRF1200 to AGRF1400, AHRF1300 to AHRF1500*, AHEF1000)	t <sub>1</sub>	2.3	Maximum
Splice Sprocket Hole Alignment	—	0	± 0.3
Body Lateral Deviation	Dh	0	± 1.0
Body Tape Plane Deviation	Dp	0	± 1.3
Ordinate to Adjacent Component Lead (AGRF400 to AGRF1100, AHRF050 to AHRF900, AHEF050 to AHEF500)	P <sub>1</sub>	3.81	± 0.7
Ordinate to Adjacent Component Lead (AGRF1200 to AGRF1400, AHRF1000 to AHRF1500, AHEF750 to AHEF1000)	P <sub>1</sub>	7.62	± 0.7
Lead Spacing (AGRF400 to AGRF1100, AHRF050 to AHRF900*, AHEF050 to AHEF500)	F	5.05	± 0.75
Lead Spacing (AGRF1200 to AGRF1400, AHRF1000 to AHRF1500*, AHEF750 to AHEF1000)	F	10.15	± 0.75
Reel Width (AGRF400 to AGRF600 & AHRF050 to AHRF450, AHEF050 to AHEF300)	w <sub>2</sub>	56.0	Maximum
Reel Width (AGRF700 to AGRF1400, AHRF550 to AHRF1500*, AHEF500 to AHEF1000)	w <sub>2</sub>	63.5	Maximum
Reel Diameter	a	370.0	Maximum
Space between Flanges* (AHEF050 to AHEF300)	w <sub>1</sub>	48.0	Maximum
Space between Flanges* (AHEF500 to AHEF1000)	w <sub>1</sub>	55.0	Maximum
Arbor Hold Diameter	c	26.0	±12.0
Core Diameter*	n	91.0	Maximum
Box	—	64/372/362	Maximum
Consecutive Missing Places	—	None	—
Empty Places per Reel	—	0.1%	Maximum

\* Differs from EIA specification.

# PolySwitch Resettable Devices

## Automotive Devices

Figure A25 – EIA Referenced Taped Component Dimensions for AGRF/AHRF/AHEF PolySwitch Automotive Devices



Figure A26 – EIA Referenced Reel Dimensions for AGRF/AHRF/AHEF PolySwitch Automotive Devices



Table A8 – Tape and Reel Specifications for AHS/ASMD/femtoASMD/picoASMD/nanoASMD/microASMD/miniASMD/ASMD PolySwitch Automotive Devices (in Millimeters)

Description	femtoASMD	picoASMD	nanoASMD	microASMD	miniASMD	ASMD	AHS080-2018	AHS120	AHS160~AHS300
	EIA 481-1	EIA 481-1	EIA 481-1	EIA 481-1	EIA 481-1	EIA 481-1	EIA 481-2	ASMD030F~ ASMD125F EIA 481-2	ASMD150F~ ASMD250F EIA 481-2
W	8.0 ± 0.30	8.0 ± 0.30	8.0 ± 0.30	8.0 ± 0.30	12.0 ± 0.30	16.0 ± 0.30	16.0 ± 0.30	16.0 ± 0.30	16.0 ± 0.30
P <sub>0</sub>	4.0 ± 0.10	4.0 ± 0.10	4.0 ± 0.10	4.0 ± 0.10	4.0 ± 0.10	4.0 ± 0.10	4.0 ± 0.10	4.0 ± 0.10	4.0 ± 0.10
P <sub>1</sub>	4.0 ± 0.10	4.0 ± 0.10	4.0 ± 0.10	4.0 ± 0.10	8.0 ± 0.10	8.0 ± 0.10	8.0 ± 0.10	8.0 ± 0.10	12.0 ± 0.10
P <sub>2</sub>	2.0 ± 0.05	2.0 ± 0.10	2.0 ± 0.05	2.0 ± 0.05	2.0 ± 0.05	2.0 ± 0.10	2.0 ± 0.10	2.0 ± 0.10	2.0 ± 0.10
A <sub>0</sub>	0.95 ± 0.05	1.70 ± 0.1	1.95 ± 0.10	2.9 ± 0.10	Table A9	Table A9	5.11 ± 0.15	5.6 ± 0.23	6.9 ± 0.23
B <sub>0</sub>	1.85 ± 0.05	2.45 ± 0.1	Table A9	3.50 ± 0.10	Table A9	Table A9	5.6 ± 0.23	8.1 ± 0.15	9.6 ± 0.15
B <sub>1</sub> max	4.35	4.35	4.35	4.35	6.15	12.1	12.1	12.1	12.1
D <sub>0</sub>	1.55 ± .05	1.55 ± .05	1.55 ± .05	1.55 ± .05	1.5 + 0.10/ -.00	1.5 + 0.10/ -.00	1.5 + 0.10/ -.00	1.5 + 0.10/ -.00	1.5 + 0.10/ -.00
F	3.50 ± 0.05	3.50 ± 0.05	3.50 ± 0.05	3.50 ± 0.05	5.50 ± 0.05	7.50 ± 0.10	7.50 ± 0.10	7.50 ± 0.10	7.50 ± 0.10
E <sub>1</sub>	1.75 ± 0.10	1.75 ± 0.10	1.75 ± 0.10	1.75 ± 0.10	1.75 ± 0.10	1.75 ± 0.10	1.75 ± 0.10	1.75 ± 0.10	1.75 ± 0.10
E <sub>2</sub> min	6.25	6.25	6.25	6.25	10.25	14.25	14.25	14.25	14.25
T max	0.3	0.3	0.3	0.3	0.35	0.35	0.4	0.4	0.4
T <sub>1</sub> max	0.1	0.1	0.1	0.1	0.1	0.1	0.1	0.1	0.1
K <sub>0</sub>	0.90 ± 0.1	Table A9	Table A9	0.9 ± 0.1	Table A9	Table A9	1.8 ± 0.15	3.2 ± 0.15	3.4 ± 0.15

## PolySwitch Resettable Devices Automotive Devices

Table A9 — Tape and Reel Specifications for picoASMDC/nanoASMDC/miniASMDC/ASMDC PolySwitch Automotive Devices (in Millimeters)

Description	nanoASMDC010F nanoASMDC012F nanoASMDC016F	nanoASMDC020F nanoASMDC025F nanoASMDC035F nanoASMDC050F/13.2	miniASMDC010F~075F miniASMDC110F/16 miniASMDC125F/16 miniASMDC150F/12 miniASMDC150F/16 miniASMDC200F/16	miniASMDC075F/24 miniASMDC075F/33 miniASMDC110F/24 miniASMDC260F/12 miniASMDC260F/13.2 miniASMDC260F/16	ASMDC030F ASMDC050F ASMDC075F ASMDC125F/33	ASMDC185F/33 ASMDC300F/24
A <sub>0</sub>	1.95 ± 0.1	1.95 ± 0.1	3.5 ± 0.1	3.7 ± 0.1	5.5 ± 0.1	5.35 ± 0.1
B <sub>0</sub>	3.5 ± 0.1	3.50 +0.1/-0.08	4.95 ± 0.1	4.9 ± 0.1	7.9 ± 0.1	7.85 ± 0.1
K <sub>0</sub>	1.27 ± 0.1	0.89 ± 0.1	0.9 ± 0.1	1.4 ± 0.1	0.9 ± 0.1	1.45 ± 0.1
Description	picoASMDC010S	picoASMDC012S	miniASMDC150F/24			
A <sub>0</sub>	1.70 ± 0.1	1.70 ± 0.1	3.7 ± 0.1			
B <sub>0</sub>	2.45 ± 0.1	2.45 ± 0.1	4.9 ± 0.1			
K <sub>0</sub>	1.12 ± 0.1	0.86 ± 0.1	1.78 ± 0.1			

Table A10— Reel Dimensions for AHS/ASMD/femtoASMDC/picoASMDC/nanoASMDC/microASMD/miniASMDC/ASMDC PolySwitch Automotive Devices (in Millimeters)

Description	femtoASMDC picoASMDC nanoASMDC microASMD	miniASMDC	ASMDC AHS ASMD
A max.	185	185	330
N min.	50	50	50
W <sub>1</sub>	8.4 + 1.5/-0.00	12.4 + 2.0/-0.00	16.4 + 2.0/-0.00
W <sub>2</sub> max.	14.4	18.4	22.4

Figure A27 — EIA Referenced Taped Component Dimensions for AHS/ASMD/femtoASMDC/picoASMDC/nanoASMDC/microASMD/miniASMDC/ASMDC PolySwitch Automotive Devices (in Millimeters)



Figure A28 — EIA Referenced Reel Dimensions for AHS/ASMD/femtoASMDC/picoASMDC/nanoASMDC/microASMD/miniASMDC/ASMDC PolySwitch Automotive Devices

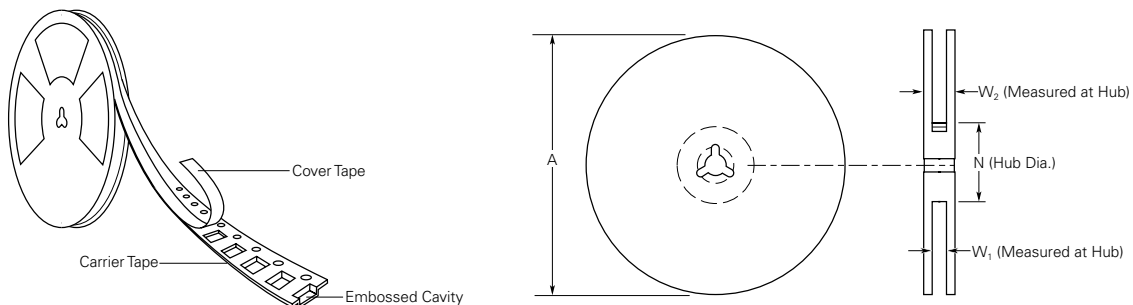

# PolySwitch Resettable Devices

## Automotive Devices

### Part Numbering System



### **Warning :**

- Users should independently evaluate the suitability of and test each product selected for their own application.
- Operation beyond the maximum ratings or improper use may result in device damage and possible electrical arcing and flame.
- These devices are intended for protection against damage caused by occasional overcurrent or overtemperature fault conditions and should not be used when repeated fault conditions or prolonged trip events are anticipated.
- Contamination of the PPTC material with certain silicone-based oils or some aggressive solvents can adversely impact the performance of the devices.
- Device performance can be impacted negatively if devices are handled in a manner inconsistent with recommended electronic, thermal, and mechanical procedures for electronic components.
- PPTC devices are not recommended for installation in applications where the device is constrained such that its PTC properties are inhibited, for example in rigid potting materials or in rigid housings, which lack adequate clearance to accommodate device expansion.
- Operation in circuits with a large inductance can generate a circuit voltage ( $Ldi/dt$ ) above the rated voltage of the device.

### **Notice:**

Information furnished is believed to be accurate and reliable. However, users should independently evaluate the suitability of and test each product selected for their own applications. Littelfuse products are not designed for, and shall not be used for, any purpose (including, without limitation, military, aerospace, medical, life-saving, life-sustaining or nuclear facility applications, devices intended for surgical implant into the body, or any other application in which the failure or lack of desired operation of the product may result in personal injury, death, or property damage) other than those expressly set forth in applicable Littelfuse product documentation. Warranties granted by Littelfuse shall be deemed void for products used for any purpose not expressly set forth in applicable Littelfuse documentation. Littelfuse shall not be liable for any claims or damages arising out of products used in applications not expressly intended by Littelfuse as set forth in applicable Littelfuse documentation. The sale and use of Littelfuse products is subject to Littelfuse Terms and Conditions of Sale, unless otherwise agreed by Littelfuse.





## Стандарт Электрон Связь

Мы молодая и активно развивающаяся компания в области поставок электронных компонентов. Мы поставляем электронные компоненты отечественного и импортного производства напрямую от производителей и с крупнейших складов мира.

Благодаря сотрудничеству с мировыми поставщиками мы осуществляем комплексные и плановые поставки широчайшего спектра электронных компонентов.

Собственная эффективная логистика и склад в обеспечивает надежную поставку продукции в точно указанные сроки по всей России.

Мы осуществляем техническую поддержку нашим клиентам и предпродажную проверку качества продукции. На все поставляемые продукты мы предоставляем гарантию .

Осуществляем поставки продукции под контролем ВП МО РФ на предприятия военно-промышленного комплекса России , а также работаем в рамках 275 ФЗ с открытием отдельных счетов в уполномоченном банке. Система менеджмента качества компании соответствует требованиям ГОСТ ISO 9001.

Минимальные сроки поставки, гибкие цены, неограниченный ассортимент и индивидуальный подход к клиентам являются основой для выстраивания долгосрочного и эффективного сотрудничества с предприятиями радиоэлектронной промышленности, предприятиями ВПК и научно-исследовательскими институтами России.

С нами вы становитесь еще успешнее!

### Наши контакты:

**Телефон:** +7 812 627 14 35

**Электронная почта:** [sales@st-electron.ru](mailto:sales@st-electron.ru)

**Адрес:** 198099, Санкт-Петербург,  
Промышленная ул, дом № 19, литера Н,  
помещение 100-Н Офис 331