

856882

358.4 MHz SAW Filter

Applications

- General Purpose Wireless
- Wireless Infrastructure
- 3G, 4G, Multistandard

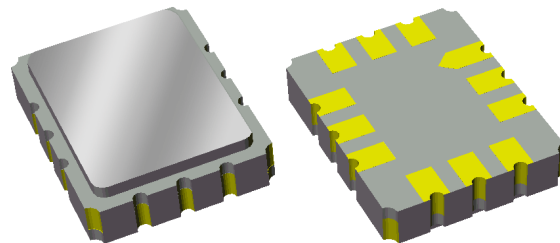

Functional Block Diagram Bal/Bal

Top view

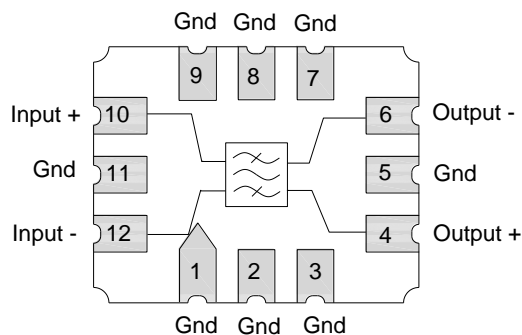

Functional Block Diagram Bal/SE

Top view

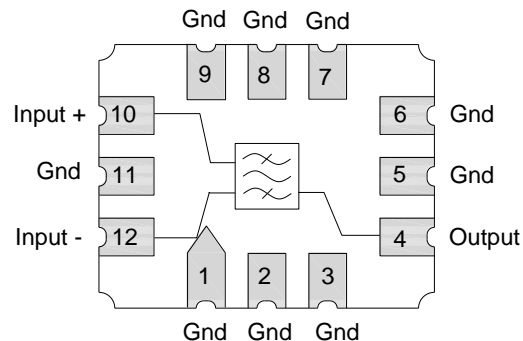

Product Features

- Usable bandwidth 39.6 MHz
- Low loss
- High attenuation
- Low EVM
- Balanced-Balanced or Balanced-Single ended operation
- Ceramic Surface Mount Package (SMP)
- Small Size: 7.01 x 5.51 x 1.70 mm
- Excellent power handling
- Hermetic **RoHS** compliant, **Pb-free**

General Description

The 856882 is a high performance IF SAW filter developed for 4G and Multistandard infrastructure applications.

It features low loss with excellent attenuation, and is designed to be used with multiple impedance values and configurations. The filter is developed for excellent in-band characteristics in order to minimize system bit-error rates.

This device is RoHS compliant and Pb-free.

Pin Configuration

Pin #	Bal/Bal	Description
10		Input +
12		Input -
4		Output +
6		Output -
1,2,3,5, 7, 8, 9, 11		Ground

Pin #	Bal/SE	Description
10		Input +
12		Input -
4		Output
1,2,3,5,6, 7, 8, 9, 11		Ground

Ordering Information

Part No.	Description
856882	packaged part
856882-EVB	evaluation board

Standard T/R size = 3000 units/reel.

Please specify the evaluation board impedance:

1. Balanced 200Ω input, Balance 200Ω output.
2. Balanced 200Ω input, Single-ended 50Ω output.
3. Balanced 100Ω input, Balance 100Ω output.

Specifications

Electrical Specifications (1, 2)

Specified Temperature Range: ⁽³⁾ -33 to +85 °C

Parameter ⁽⁴⁾	Conditions	Min	Typical ⁽⁵⁾	Max	Units
Center Frequency		-	358.4	-	MHz
Insertion Loss	At 358.4 MHz	-	9.5	11.5	dB
Amplitude Variation ⁽⁶⁾	338.6 – 378.2 MHz	-	0.35	1.0	dB p-p
Absolute Group Delay	At 358.4 MHz	-	0.43	0.5	µs
Group Delay Variation ⁽⁶⁾	338.6 – 378.2 MHz	-	21	50	ns p-p
Time side-lobe response attenuation	(1.0 – 500 µs)	40	45	-	dB
IIP3	Tones 5 MHz separated power > 5dBm per tone	45	50	-	dBm
EVM ⁽⁷⁾		-	1.3	3	%
Absolute Attenuation ⁽⁸⁾					
	10.0 – 253.4 MHz	55	61	-	dB
	253.4 – 270.0 MHz	53	56	-	dB
	270.0 – 294.4 MHz	55	58	-	dB
	294.4 – 312.4 MHz	40	53	-	dB
	312.4 – 326.4 MHz	25	44	-	dB
	388.4 – 404.4 MHz	30	37	-	dB
	404.4 – 422.4 MHz	40	49	-	dB
	422.4 – 463.4 MHz	45	52	-	dB
	463.4 – 660.0 MHz	55	66	-	dB
	660.0 – 780.0 MHz	35	38	-	dB
	780.0 – 3000 MHz	55	62	-	dB
Input/Output Return Loss	338.6 – 378.2 MHz	10	12	-	dB
Source/Load Impedance ⁽⁹⁾		-	200, 100, 50	-	Ω

Notes:

- All specifications are based on the TriQuint schematics for the different impedances shown on page 3, 4 & 5.
- An external impedance matching network with $\pm 2\%$ tolerance will be necessary to achieve the proposed specifications.
- In production, devices will be tested at room temperature to a guardbanded specification to ensure electrical compliance over temperature.
- Electrical margin has been built into the design to account for the variations due to temperature drift and manufacturing tolerances.
- Typical values are based on average measurements at room temperature.
- These Variations are defined as the difference between the lowest loss and the highest loss within the defined frequency points.
- Measured with an RRC filtered QPSK modulated signal with a BW of 3.84 MHz placed anywhere within 338.6 to 378.2 MHz.
- Relative to insertion loss at center frequency.
- See the impedance options in the ordering information section on page 1.

Impedance option #1 – 200Ω Bal Input, 200Ω Bal Output

Schematic

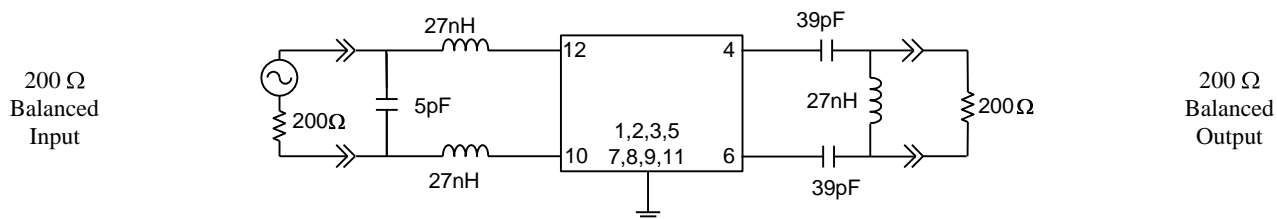

Note: Actual matching values may vary due to PCB layout and parasitic

PC Board

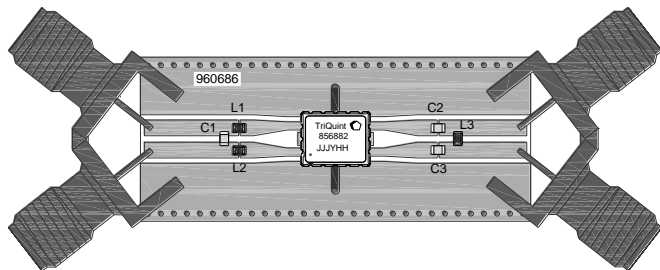

Notes:

- Top, middle & bottom layers: 1 oz copper
- Substrates: FR4 dielectric, .031" thick
- Finish plating: Nickel: 3-8μm thick, Gold: .03-.2μm thick
- Hole plating: Copper min .0008μm thick

Mounting Configuration

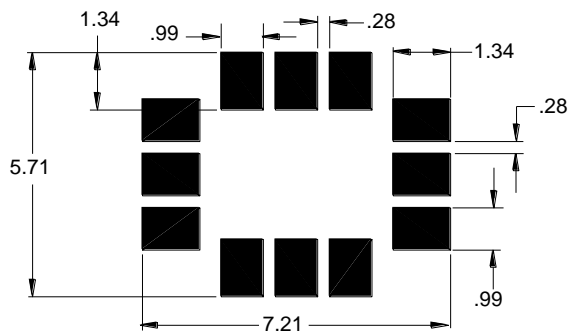

Notes:

1. All dimensions are in millimeters.
2. This footprint represents a recommendation only.

Bill of Material

Reference Desg.	Value	Description	Manufacturer	Part Number
C1	5.0 pF	Chip Ceramic, 0603, 5%	Panasonic	ECU-V1H0050CCV
C2	39 pF	Chip Ceramic, 0603, 5%	Panasonic	ECU-V1H390KCV
C3	39 pF	Chip Ceramic, 0603, 5%	Panasonic	ECU-V1H390KCV
L1	27nH	Coil Wire-wound, 0603, 5%	Coilcraft	0603CS-27NXJBC
L2	27nH	Coil Wire-wound, 0603, 5%	Coilcraft	0603CS-27NXJBC
L3	27nH	Coil Wire-wound, 0603, 5%	Coilcraft	0603CS-27NXJBC
SMA	N/A	SMA connector	Johnson Components	142-0701-801
PCB	N/A	3-layer	multiple	960686

Impedance option #2 – 200Ω Bal Input, 50Ω SE Output

Schematic

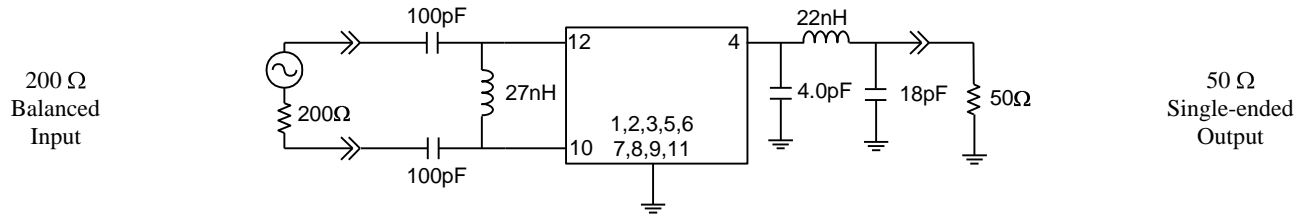

Note: Actual matching values may vary due to PCB layout and parasitic

PC Board

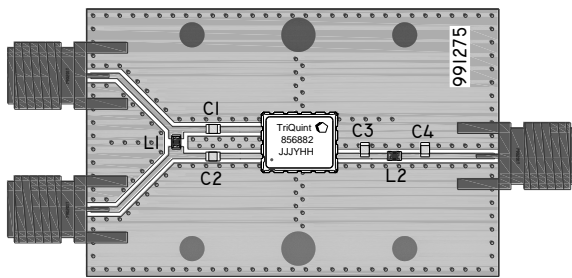

Notes:

- Top, middle & bottom layers: 1 oz copper
- Substrates: FR4 dielectric, .031" thick
- Finish plating: Nickel: 3-8μm thick, Gold: .03-.2μm thick
- Hole plating: Copper min .0008μm thick

Mounting Configuration

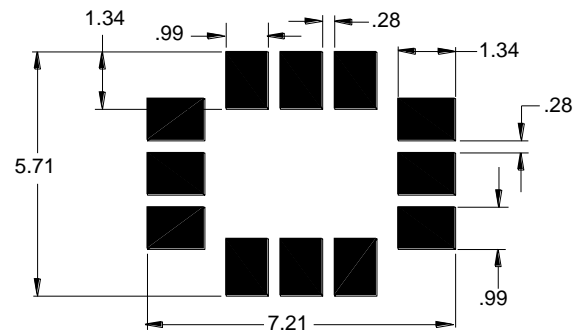

Notes:

- 3. All dimensions are in millimeters.
- 4. This footprint represents a recommendation only.

Bill of Material

Reference Desg.	Value	Description	Manufacturer	Part Number
C1	100 pF	Chip Ceramic, 0603, 5%	Panasonic	ECU-V1H101KCV
C2	100 pF	Chip Ceramic, 0603, 5%	Panasonic	ECU-V1H101KCV
C3	4.0 pF	Chip Ceramic, 0603, 5%	Panasonic	ECU-V1H040CCV
C4	18 pF	Chip Ceramic, 0603, 5%	Panasonic	ECU-V1H0180KCV
L1	27 nH	Coil Wire-wound, 0603, 5%	MuRata	LQW18AN27NJ00
L2	22 nH	Coil Wire-wound, 0603, 5%	MuRata	LQW18AN22NJ00
SMA	N/A	SMA connector	Johnson Components	142-0701-801
PCB	N/A	3-layer	multiple	991275

Impedance option #3 100Ω Bal Input, 100Ω Bal Output

Schematic

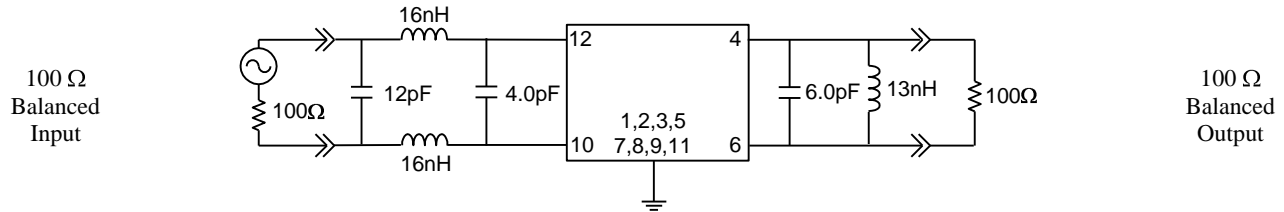

Note: Actual matching values may vary due to PCB layout and parasitic

PC Board

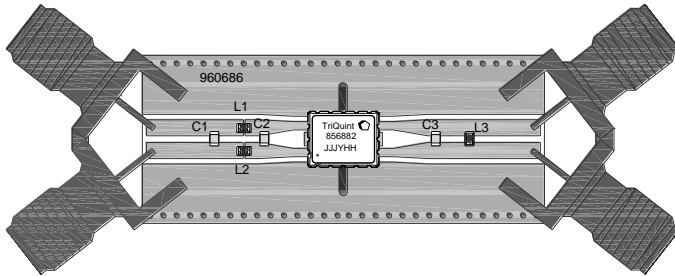

Notes:

- Top, middle & bottom layers: 1 oz copper
- Substrates: FR4 dielectric, .031" thick
- Finish plating: Nickel: 3-8μm thick, Gold: .03-.2μm thick
- Hole plating: Copper min .0008μm thick

Mounting Configuration

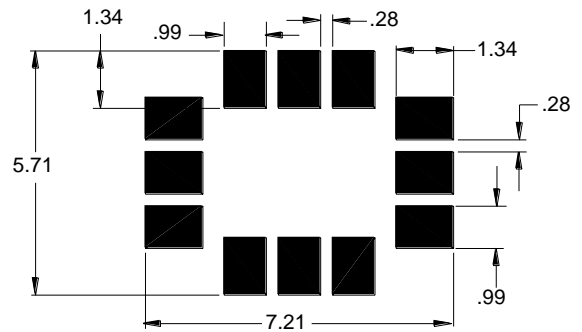

Notes:

- 5. All dimensions are in millimeters.
- 6. This footprint represents a recommendation only.

Bill of Material

Reference Desg.	Value	Description	Manufacturer	Part Number
C1	12 pF	Chip Ceramic, 0603, 5%	Panasonic	ECU-V1H120JCV
C2	4.0 pF	Chip Ceramic, 0603, 5%	Panasonic	ECU-V1H040CCV
C3	6.0 pF	Chip Ceramic, 0603, 5%	Panasonic	ECU-V1H060CCV
L1	16 nH	Coil Wire-wound, 0603, 5%	MuRata	LQW18AN16NJ00
L2	16 nH	Coil Wire-wound, 0603, 5%	MuRata	LQW18AN16NJ00
L3	13 nH	Coil Wire-wound, 0603, 5%	MuRata	LQW18AN13NJ00
SMA	N/A	SMA connector	Johnson Components	142-0701-801
PCB	N/A	3-layer	multiple	960686

Typical Performance (at room temperature)

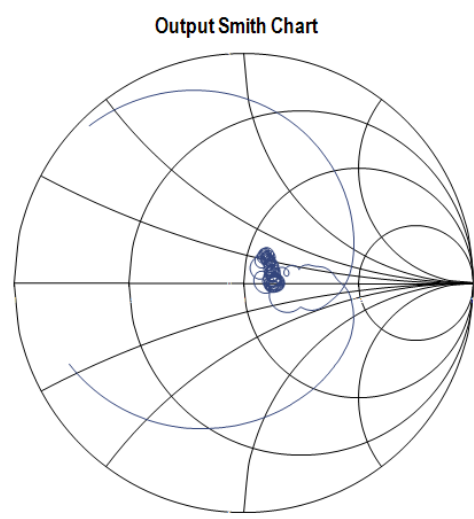
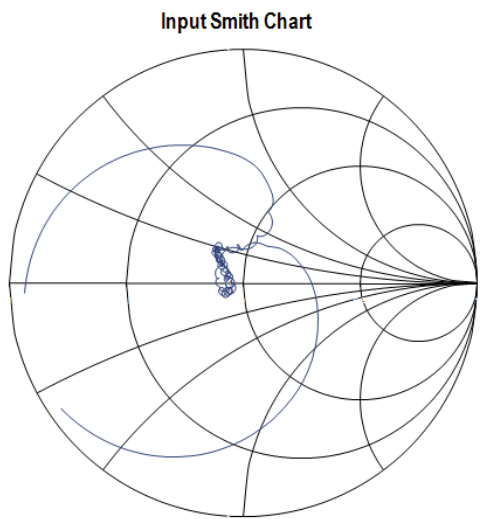
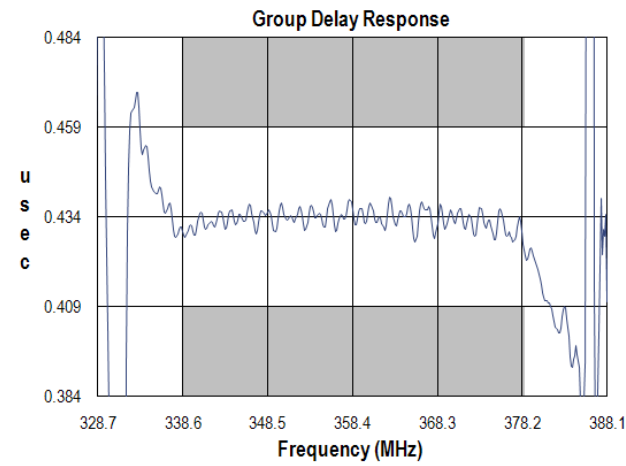
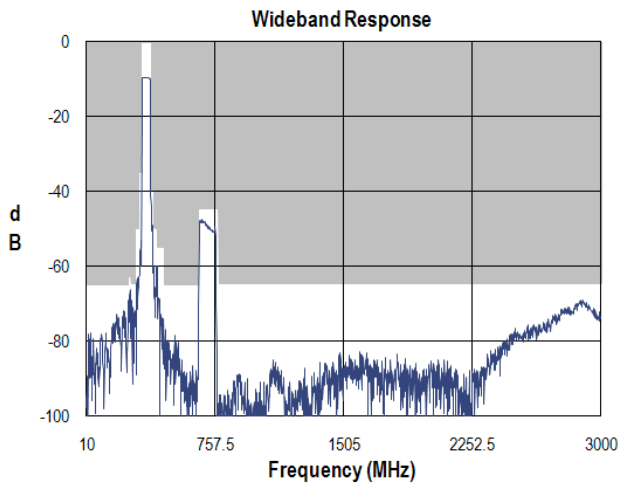
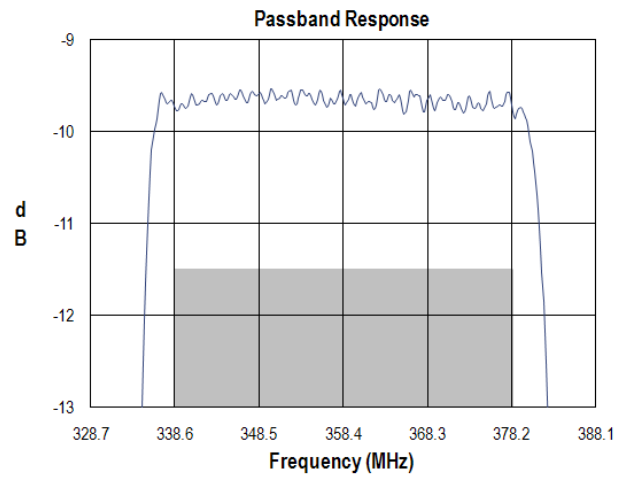
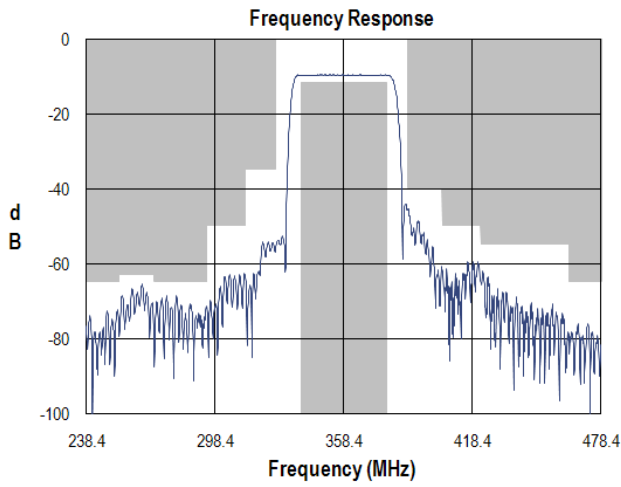

Mechanical Information

Package Information, Dimensions and Marking

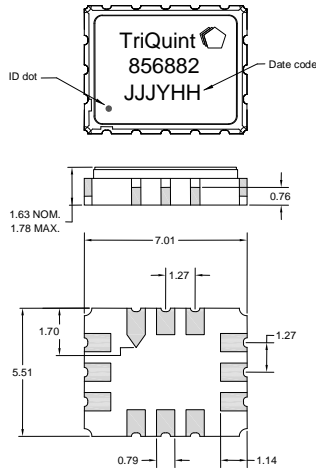

Package Style: SMP-28B
 Dimensions: 7.01 x 5.51 x 1.63 mm

Body: Al_2O_3 ceramic
 Lid: Kovar, Ni plated
 Terminations: Au plating 0.5 - 1.0 μ m, over a 2-6 μ m Ni plating

All dimensions shown are nominal in millimeters
 All tolerances are ± 0.15 mm except overall length and width ± 0.10 mm

The date code consists of: day of the current year (Julian, 3 digits), Y = last digit of the year (1 digit), and HH = hour (2 digits)

Tape and Reel Information

Standard T/R size = 3000 units/reel. All dimensions are in millimeters

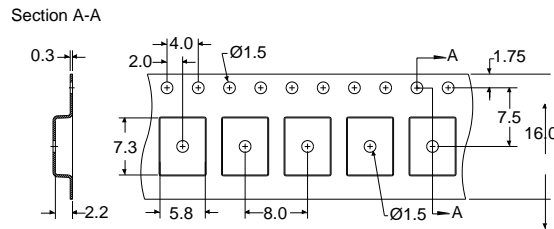
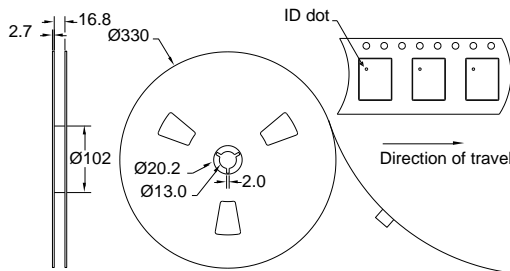

Absolute Maximum Ratings

Parameter	Condition	Value	Unit
Operating Temperature range		-33 to +85	$^{\circ}$ C
Storage Temperature range		-40 to +85	$^{\circ}$ C
Input Power	24 Hrs at 50 $^{\circ}$ C, in band	+19	dBm
	24 Hrs at 50 $^{\circ}$ C, out of band	+25	dBm
DC Voltage	Between input/output and ground	5	V
DC Voltage	Between terminals 10/12 or 4/6	5	V
Moisture Sensitivity level		MSL3 or better	-

Operation of this device outside the parameter ranges given above may cause permanent damage.

Product Compliance Information

ESD Information



Caution! ESD-Sensitive Device

ESD Rating: 1B

Value: Passes ≥ 550 V min.
 Test: Human Body Model (HBM)
 Standard: JEDEC Standard JESD22-A114

ESD Rating: B

Value: Passes ≥ 350 V min.
 Test: Machine Model (MM)
 Standard: JEDEC Standard JESD22-A115

MSL Rating

Devices are Hermetic, therefore MSL is not applicable

Solderability

Compatible with the latest version of J-STD-020, lead free solder, 260°C

Refer to [Soldering Profile](#) for recommended guidelines.

This part is compliant with EU 2002/95/EC RoHS directive (Restrictions on the Use of Certain Hazardous Substances in Electrical and Electronic Equipment).

This product also has the following attributes:

- Halogen Free (Chlorine, Bromine)
- Antimony Free
- TBBP-A (C₁₅H₁₂Br₄O₂) Free
- PFOS Free
- SVHC Free

Contact Information

For the latest specifications, additional product information, worldwide sales and distribution locations, and information about TriQuint:

Web: www.triquint.com Tel: +1.407.886.8860
 Email: info-sales@tqs.com Fax: +1.407.886.7061

For technical questions and application information:

Email: flapplication.engineering@tqs.com

Important Notice

The information contained herein is believed to be reliable. TriQuint makes no warranties regarding the information contained herein. TriQuint assumes no responsibility or liability whatsoever for any of the information contained herein. TriQuint assumes no responsibility or liability whatsoever for the use of the information contained herein. The information contained herein is provided "AS IS, WHERE IS" and with all faults, and the entire risk associated with such information is entirely with the user. All information contained herein is subject to change without notice. Customers should obtain and verify the latest relevant information before placing orders for TriQuint products. The information contained herein or any use of such information does not grant, explicitly or implicitly, to any party any patent rights, licenses, or any other intellectual property rights, whether with regard to such information itself or anything described by such information.

TriQuint products are not warranted or authorized for use as critical components in medical, life-saving, or life-sustaining applications, or other applications where a failure would reasonably be expected to cause severe personal injury or death.



Стандарт Электрон Связь

Мы молодая и активно развивающаяся компания в области поставок электронных компонентов. Мы поставляем электронные компоненты отечественного и импортного производства напрямую от производителей и с крупнейших складов мира.

Благодаря сотрудничеству с мировыми поставщиками мы осуществляем комплексные и плановые поставки широчайшего спектра электронных компонентов.

Собственная эффективная логистика и склад в обеспечивает надежную поставку продукции в точно указанные сроки по всей России.

Мы осуществляем техническую поддержку нашим клиентам и предпродажную проверку качества продукции. На все поставляемые продукты мы предоставляем гарантию .

Осуществляем поставки продукции под контролем ВП МО РФ на предприятия военно-промышленного комплекса России , а также работаем в рамках 275 ФЗ с открытием отдельных счетов в уполномоченном банке. Система менеджмента качества компании соответствует требованиям ГОСТ ISO 9001.

Минимальные сроки поставки, гибкие цены, неограниченный ассортимент и индивидуальный подход к клиентам являются основой для выстраивания долгосрочного и эффективного сотрудничества с предприятиями радиоэлектронной промышленности, предприятиями ВПК и научно-исследовательскими институтами России.

С нами вы становитесь еще успешнее!

Наши контакты:

Телефон: +7 812 627 14 35

Электронная почта: sales@st-electron.ru

Адрес: 198099, Санкт-Петербург,
Промышленная ул, дом № 19, литера Н,
помещение 100-Н Офис 331