

MIC2039



High-Accuracy, High-Side, Adjustable Current Limit Power Switch

General Description

The MIC2039 is a high-side MOSFET power distribution switch providing increased system reliability by using 5% current-limit accuracy.

The MIC2039 has an operating input voltage range from 2.5V to 5.5V, is internally current limited, and has thermal shutdown to protect the device and system. The MIC2039 is offered with either active-high or active-low logic level enable input controls. It has an open drain fault status output flag with a built-in 32ms delay that asserts low during overcurrent or thermal-shutdown conditions.

The MIC2039 switches feature an adjustable output current limit that is resistor programmable from 0.2A to 2.5A. The MIC2039 switch also offers a unique, Kickstart feature that allows momentary high-current surges up to the secondary current limit (I_{LIMIT_2nd}) during startup or while operating in steady state. This is useful for charging loads with high inrush currents, such as capacitors. After an overcurrent condition is established, these switches enter into a constant current-limit mode unless the die temperature exceeds the thermal-shutdown specification.

The MIC2039 is available in 6-pin SOT-23 and 6-pin 2mm x 2mm thin DFN packages. The MIC2039 has an operating junction temperature range of -40°C to $+125^{\circ}\text{C}$.

Data sheets and support documentation are available on Micrel's web site at: www.micrel.com.

Features

- $\pm 5\%$ current limit accuracy
- Input supply range from 2.5V to 5.5V
- Low quiescent current: 100 μA typical (switch ON)
- 75m Ω typical $R_{DS(ON)}$ at 5.0V
- 0.2A to 2.5A adjustable output current
- Kickstart – momentary secondary current-limit threshold (120ms period)
- Soft-start functionality
- Undervoltage lockout (UVLO)
- Fast 10 μs short-circuit response time (non-Kickstart options)
- Fault status output flag
- Logic-controlled enable (active-high, active-low)
- Thermal shutdown
- Pin compatible with the MIC2009/MIC2019
- 6-pin 2mm x 2mm thin DFN and 6-pin SOT-23 packages
- Junction temperature range from -40°C to $+125^{\circ}\text{C}$

Applications

- USB peripherals and USB 2.0/3.0 compatible
- DTV/STB
- Notebooks and consumer electronics
- General-purpose power distribution

Typical Application

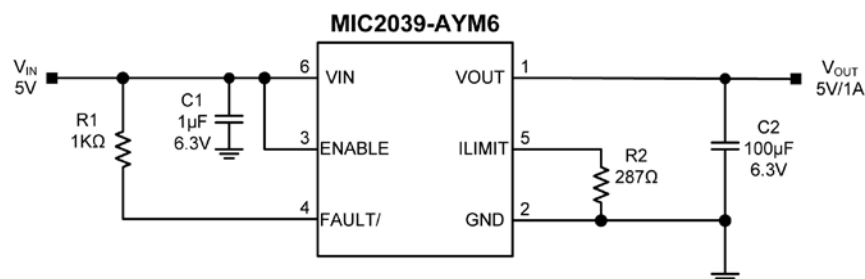

Ordering Information

Part Number	Top Mark ⁽¹⁾	Current Limit	Enable	Kickstart	Package
MIC2039AYM6	<u>39</u> A	Adjustable	Active High	No	SOT-23-6L
MIC2039BYM6	<u>39</u> B	Adjustable	Active Low	No	SOT-23-6L
MIC2039AYMT	3A9	Adjustable	Active High	No	6-pin 2mm x 2mm Thin DFN ⁽²⁾
MIC2039BYMT	B39	Adjustable	Active Low	No	6-pin 2mm x 2mm Thin DFN ⁽²⁾
MIC2039EYM6	<u>39</u> E	Adjustable	Active High	Yes	SOT-23-6L
MIC2039FYM6	<u>39</u> F	Adjustable	Active Low	Yes	SOT-23-6L
MIC2039EYMT	D39	Adjustable	Active High	Yes	6-pin 2mm x 2mm Thin DFN ⁽²⁾
MIC2039FYMT	F39	Adjustable	Active Low	Yes	6-pin 2mm x 2mm Thin DFN ⁽²⁾

Notes:

1. Under-bar symbol () may not be to scale.
2. Thin DFN is a GREEN RoHS-compliant package. Lead finish is NiPdAu. Mold compound is Halogen Free.

Pin Configuration

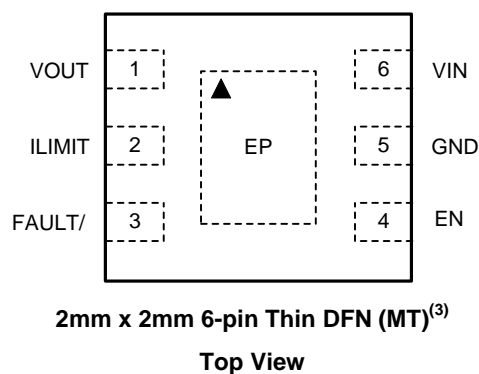
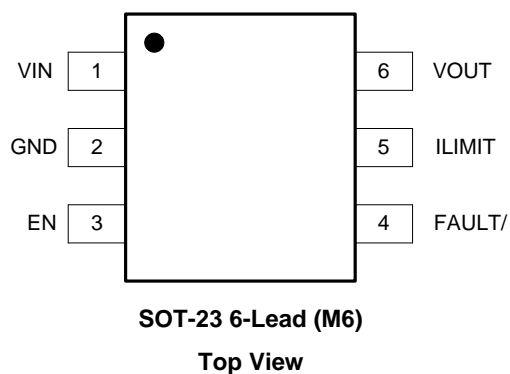

Notes:

3. Thin DFN ▲ = Pin 1 identifier.

Pin Description

Pin Number		Pin Name	Pin Function
SOT-23-6L	6-pin 2mmx2mm Thin DFN		
1	6	VIN	Input: Power switch and logic supply input.
2	5	GND	Ground: Input and output return pin.
3	4	EN	Enable (Input): Logic compatible, enable control input that allows switch turn-on/off. Do not leave the EN pin floating.
4	3	FAULT/	Fault Status Flag (Output): Active-low, open-drain output. A logic low state indicates an overcurrent or thermal shutdown condition. An overcurrent condition must last longer than t_{FAULT} to assert FAULT/. A pull-up resistor (10k Ω recommended) to an external supply is required.
5	2	ILIMIT	Current Limit Set: Current limit adjust setting. Connect a resistor from this pin to GND to set the current limit, but do not leave the ILIMIT pin floating.
6	1	VOUT	Switch Output: Power switch output.
—	EP	ePad	Exposed Pad: Exposed pad on bottom of package. Connect to electrical ground for optimum thermal dissipation.

Absolute Maximum Ratings⁽⁴⁾

V _{IN} to GND.....	-0.3V to +6V
V _{OUT} to GND.....	-0.3V to +6V
V _{ILIMIT} to GND.....	-0.3V to +6V
V _{ENABLE} to GND.....	-0.3V to +6V
V _{FAULT/} to GND.....	-0.3V to +6V
FAULT/ Current (I _{FAULT/}).....	25mA
Maximum Power Dissipation (P _D).....	Internally Limited
Lead Temperature (soldering, 10s).....	260°C
Storage Temperature (T _S).....	-65°C to +150°C
ESD Rating ⁽⁶⁾	
HBM.....	3kV
MM.....	300V

Operating Ratings⁽⁵⁾

Supply Voltage (V _{IN}).....	+2.5V to +5.5V
V _{EN} , V _{FAULT/}	-0.3V to +5.5V
V _{ILIMIT} , V _{OUT}	-0.3V to V _{IN}
Junction Temperature (T _J).....	-40°C to +125°C
Package Thermal Resistance	
SOT-23-6 (θ _{JA}).....	177.2°C/W
6-pin 2mm × 2mm DFN (θ _{JA}).....	90°C/W

Electrical Characteristics⁽⁷⁾

V_{IN} = V_{EN} = 5V; C_{IN} = 1μF; C_{OUT} = 1μF T_J = 25°C. **Bold** values indicate -40°C ≤ T_J ≤ +125°C, unless noted otherwise.

Symbol	Parameter	Condition	Min.	Typ.	Max.	Units
Power Supply Input						
V _{IN}	Input Voltage Range		2.5		5.5	V
V _{UVLO}	Input Supply Undervoltage Lockout Threshold	V _{IN} rising	2.0	2.25	2.5	V
		V _{IN} falling	1.9	2.15	2.4	
V _{UVLOHYS}	Input Supply Undervoltage Lockout Threshold Hysteresis	V _{IN} rising or V _{IN} falling		100		mV
I _{DD}	Supply Current	Switch OFF (I _{OUT} = 0A)	Active-high Enable (A): V _{EN} = 0V, V _{IN} = 5V	0.75	5	μA
			Active-low Enable (B): V _{EN} = V _{IN} = 5V			
		Switch ON (I _{OUT} = 0A)	Active-high Enable (A): V _{EN} = 1.5V, V _{IN} = 5V	100	300	
			Active-low Enable (B): V _{EN} = 0V, V _{IN} = 5V			
Power MOSFET						
R _{DS(ON)}	Switch On Resistance	V _{IN} = 2.5V, I _{OUT} = 350mA		100	177	mΩ
		V _{IN} = 3.3V, I _{OUT} = 350mA		85	145	
		V _{IN} = 5V, I _{OUT} = 350mA		75	125	
I _{LKG}	Output Leakage Current	Switch Off, V _{OUT} = 0V		0.22	15	μA

Notes:

4. Exceeding the absolute maximum rating may damage the device.
5. The device is not guaranteed to function properly outside its operating rating.
6. Devices are ESD sensitive. Handling precautions recommended. Human body model (HBM), 1.5kΩ in series with 100pF.
7. Specification for packaged product only.

Electrical Characteristics⁽⁷⁾ (Continued)

$V_{IN} = V_{EN} = 5V$; $C_{IN} = 1\mu F$; $C_{OUT} = 1\mu F$ $T_J = 25^\circ C$. **Bold** values indicate $-40^\circ C \leq T_J \leq +125^\circ C$, unless noted otherwise.

Symbol	Parameter	Condition	Min.	Typ.	Max.	Units
Current Limit						
I_{LIMIT}	Current Limit (Resistor values are standard 0.1% values)	$R_{LIMIT} = 115\Omega$, $V_{IN} = 5V$, $V_{OUT} = 0.8V \times V_{IN}$	2.35	2.5	2.65	A
		$R_{LIMIT} = 115\Omega$, $V_{IN} = 2.5V$, $V_{OUT} = 0V \times V_{IN}$	2.6	2.85	3.1	
		$R_{LIMIT} = 145\Omega$, $V_{IN} = 5V$, $V_{OUT} = 0.8V \times V_{IN}$	1.90	2.0	2.10	
		$R_{LIMIT} = 287\Omega$, $V_{IN} = 5V$, $V_{OUT} = 0.8V \times V_{IN}$	0.95	1.0	1.05	
		$R_{LIMIT} = 576\Omega$, $V_{IN} = 5V$, $V_{OUT} = 0.8V \times V_{IN}$	0.475	0.50	0.525	
$R_{LIMIT} = 1.45k\Omega$, $V_{IN} = 5V$, $V_{OUT} = 0.8V \times V_{IN}$	0.19	0.20	0.21			
I_{LIMIT_2nd}	Secondary Current Limit (Kickstart parts only)	$V_{OUT} = 0V$	2.2	3.2	6	A
Symbol	Parameter	Condition	Min.	Typ.	Max.	Units
I/O						
V_{EN}	Enable Voltage	Logic Low			0.5	V
		Logic High	1.5			
I_{EN}	Enable Input Current	$0V \leq V_{EN} \leq 5V$		1		μA
$R_{FAULT/}$	FAULT/ Output Resistance	$I_{OUT} = 10mA$			25	Ω
I_{FAULT_OFF}	FAULT/ Off Current	$V_{FAULT/} = V_{IN}$			10	μA
Thermal Protection						
T_{SD}	Thermal-Shutdown Threshold	T_J rising		157		$^\circ C$
T_{SDHYS}	Thermal-Shutdown Hysteresis			15		$^\circ C$
Timing Specifications (AC Parameters)						
t_{RISE}	Output Turn-on Rise Time ⁽⁸⁾	$R_{LOAD} = 10\Omega$; $C_{OUT} = 1\mu F$		700		μs
t_{FALL}	Output Turn-off Fall Time ⁽⁸⁾	$V_{EN} = OFF$; $R_{LOAD} = 10\Omega$; $C_{OUT} = 1\mu F$		32		μs
t_{ON_DLY}	Output Turn-on Delay ⁽⁸⁾	$R_{LOAD} = 10\Omega$; $C_{OUT} = 1\mu F$		700		μs
t_{OFF_DLY}	Output Turn-off Delay ⁽⁸⁾	$R_{LOAD} = 10\Omega$; $C_{OUT} = 1\mu F$		5		μs
t_{SC_RESP}	Short Circuit Response Time ⁽⁸⁾	$V_{OUT} = 0V$ (short circuit)		10		μs
$t_{FAULT/}$	Overcurrent Fault Response Delay Time ⁽⁸⁾	Non-Kickstart parts	16	32	49	ms
$t_{KICKSTART}$	Overcurrent Fault Response Delay During Kickstart ⁽⁸⁾	Kickstart parts only	64	120	200	ms

Note:

8. See "Timing Diagrams" (Figures 1 through 4).

Timing Diagrams

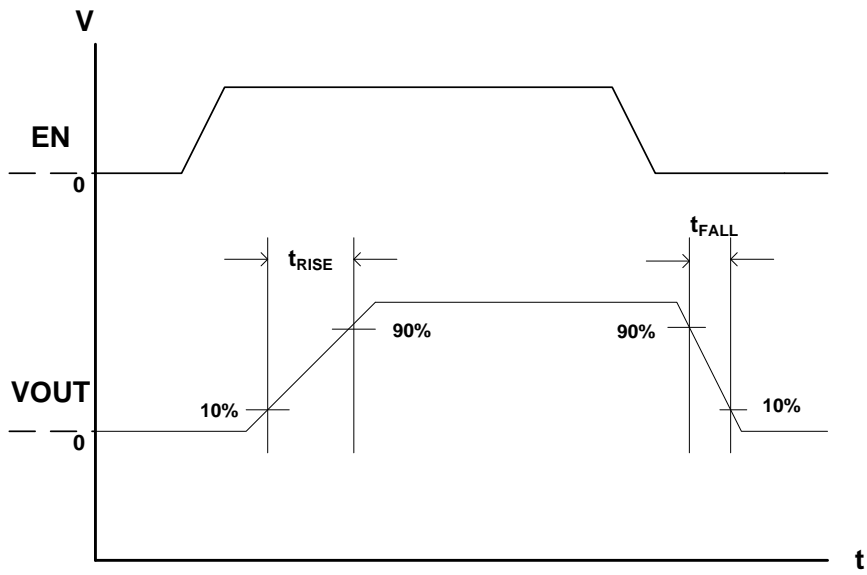

Figure 1. Output Rise/Fall Time

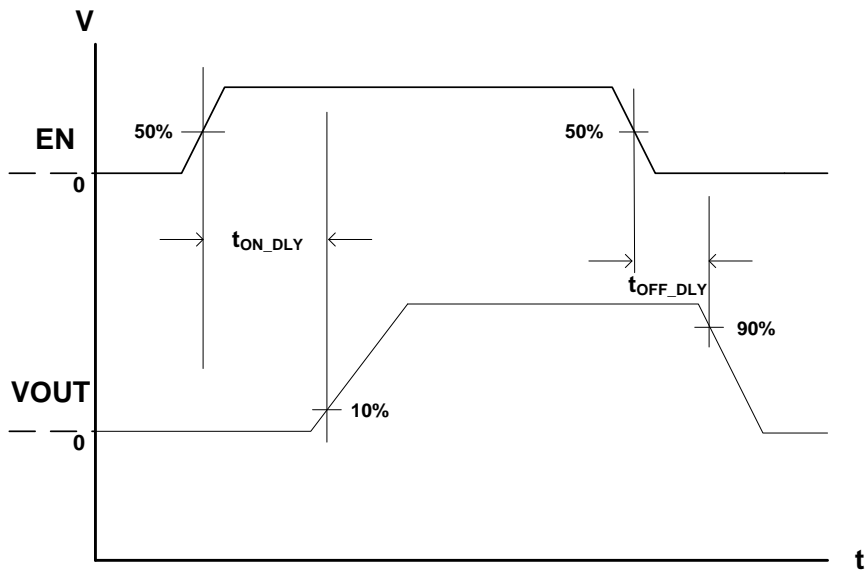

Figure 2. Turn-On/Off Delay

Timing Diagrams (Continued)

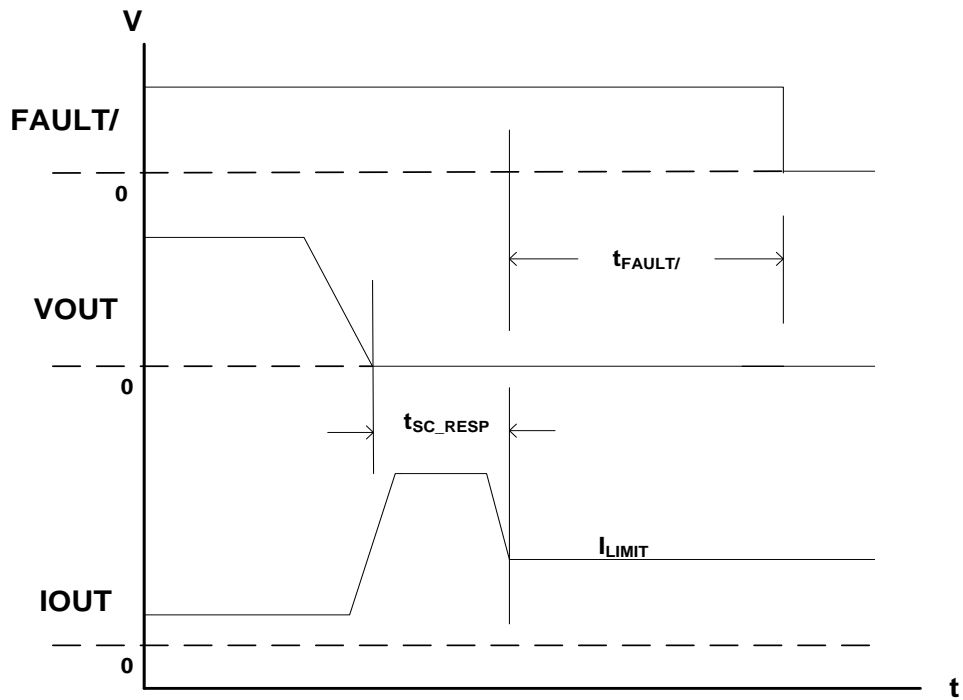

Figure 3. Short Circuit Response Time and Overcurrent Fault Flag Delay (Non-Kickstart)

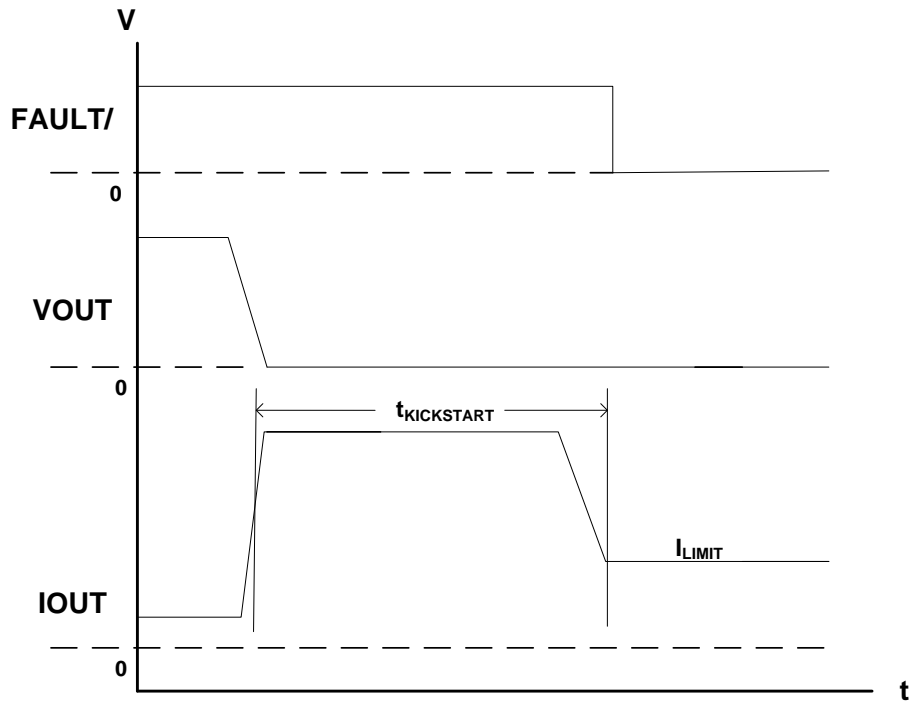
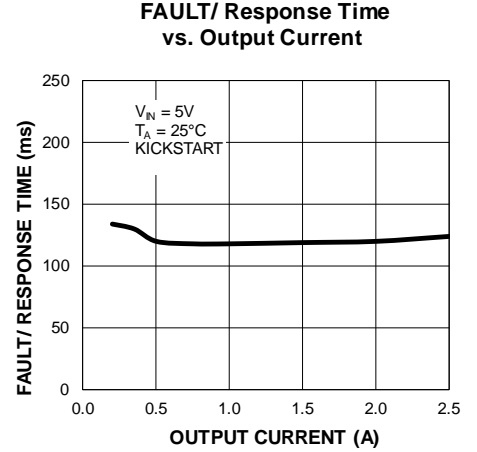
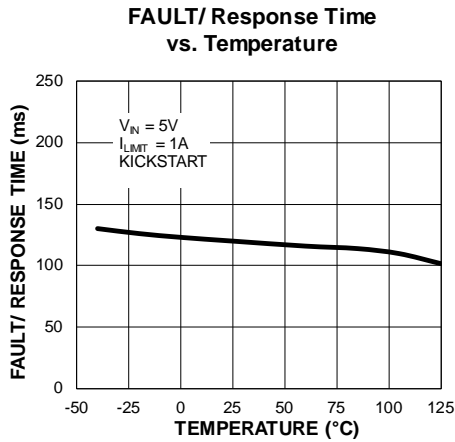
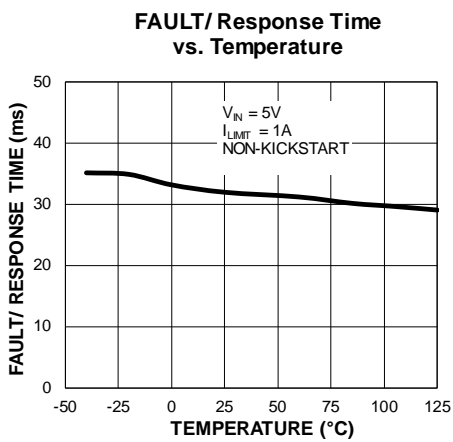
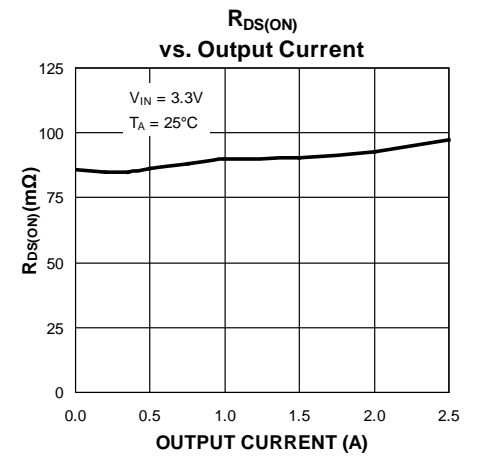
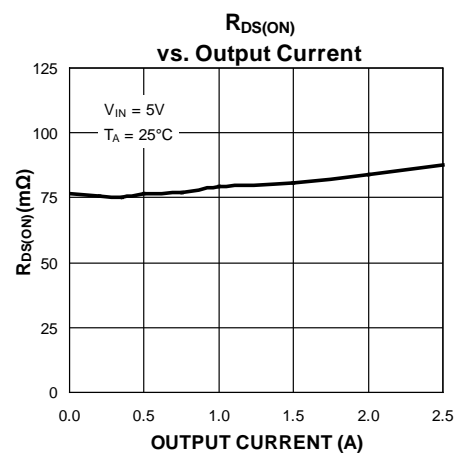
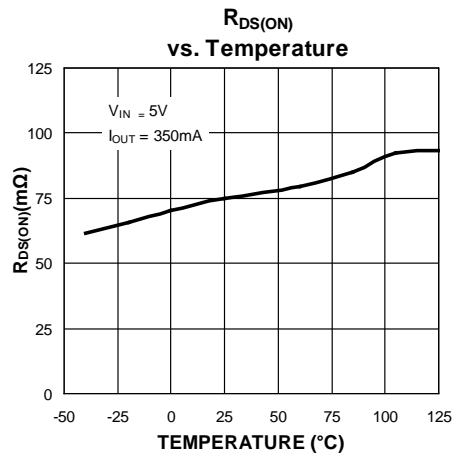
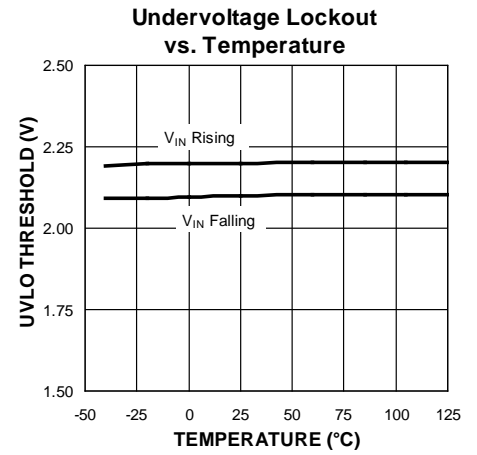
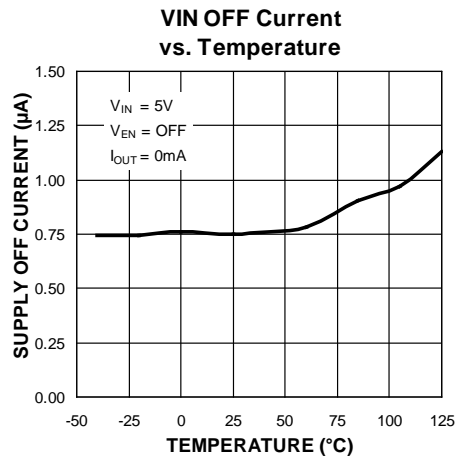
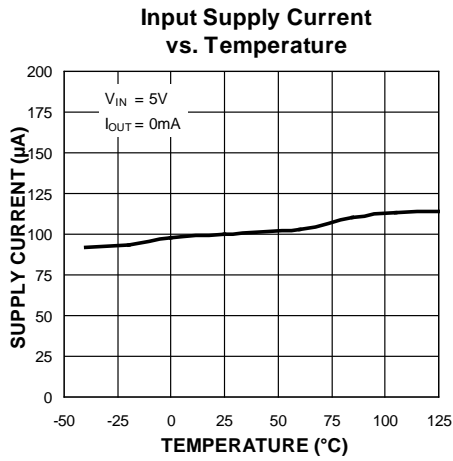
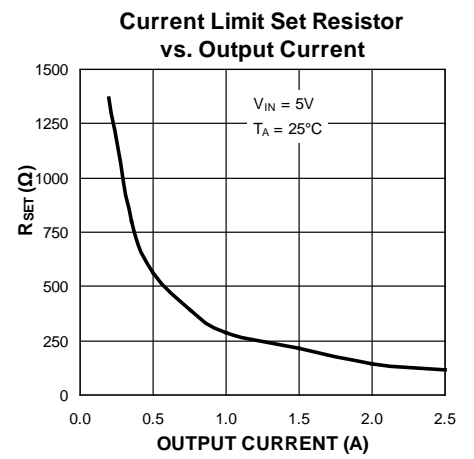
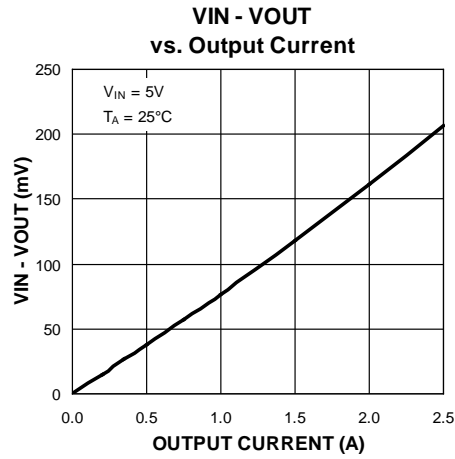
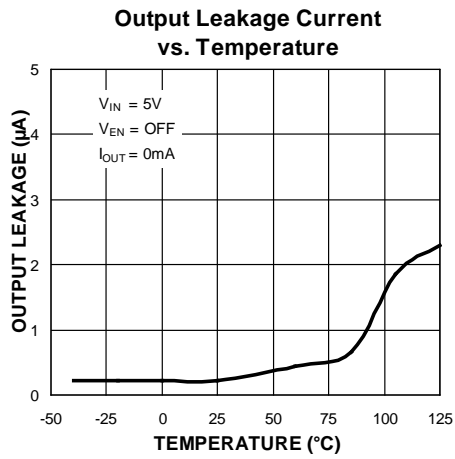

Figure 4. Overcurrent Fault Flag Delay (Kickstart)

Typical Characteristics



Typical Characteristics (Continued)



Functional Characteristics

Soft-Start Turn-On

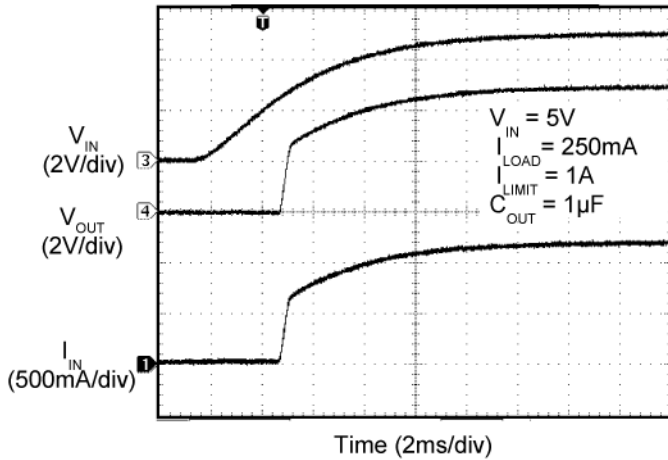

Soft-Start Turn-Off

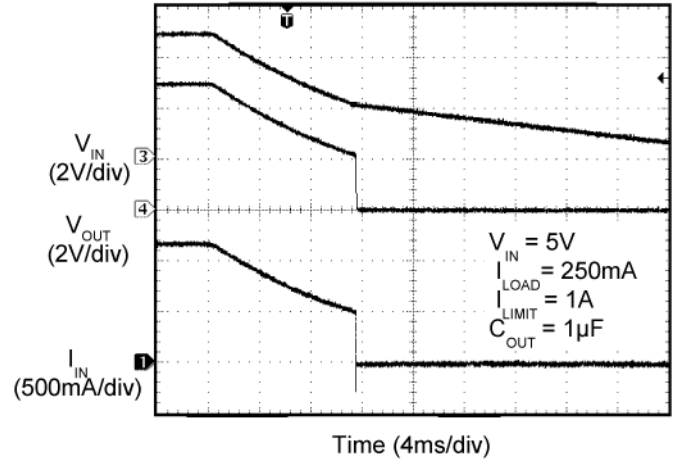

Enable Turn-On

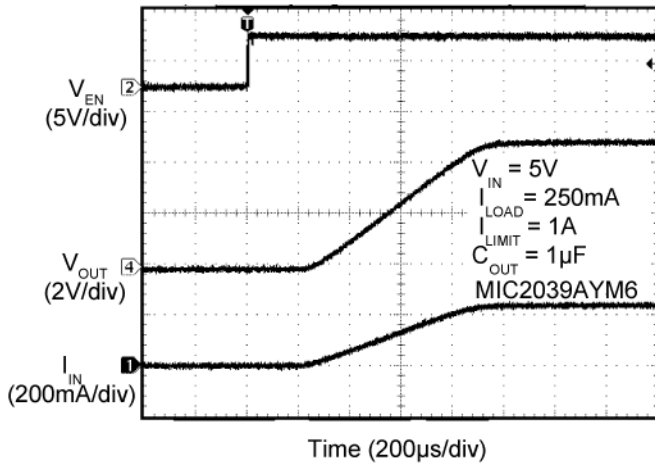

Enable Turn-Off

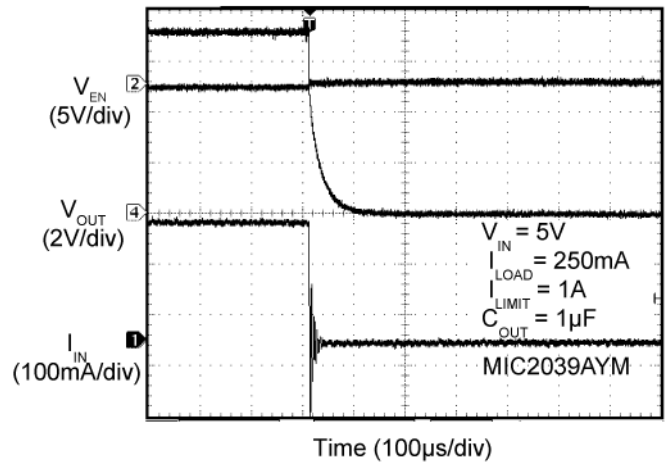

Turn-On Into Short Circuit

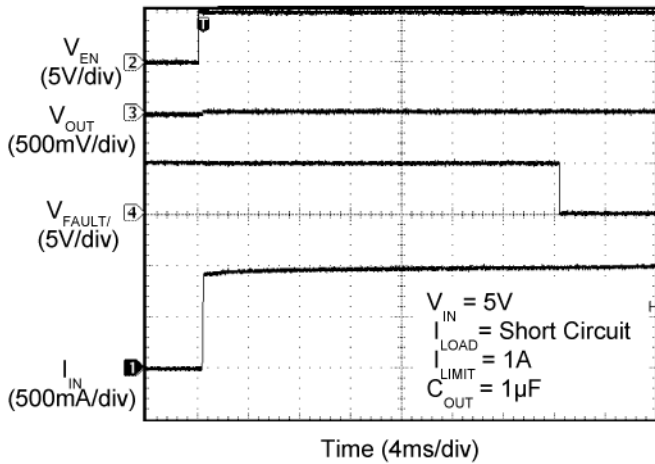

Turn-On Into Short (Kickstart)

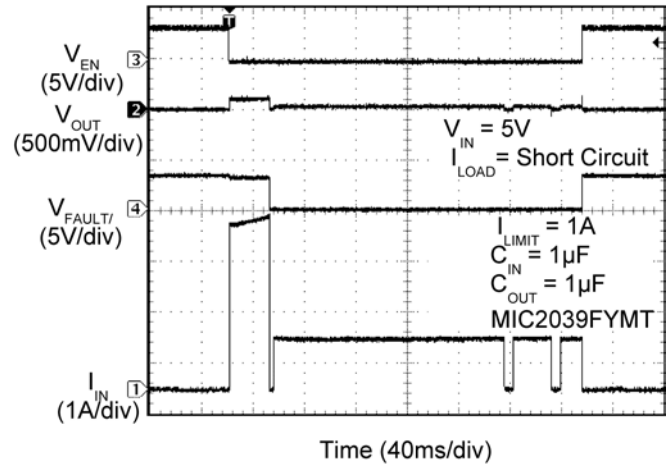

Functional Characteristics (Continued)

Current Limit Response

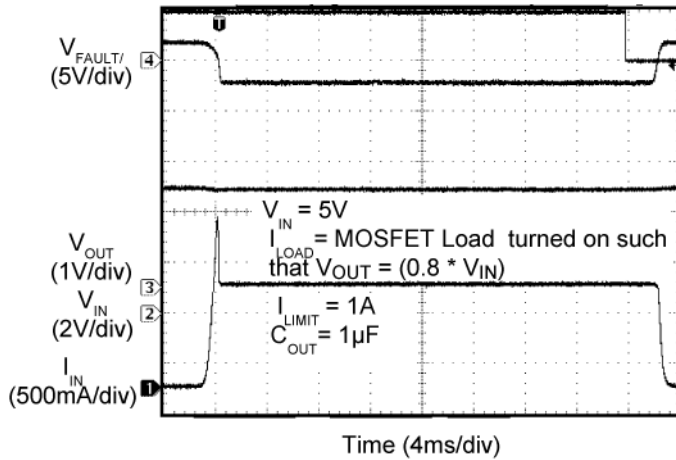

Output Recovery from Short Circuit

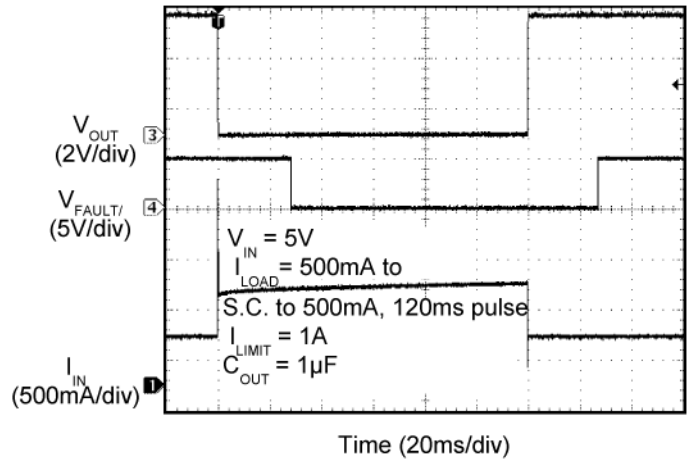

Output Recovery from S.C. - Kickstart

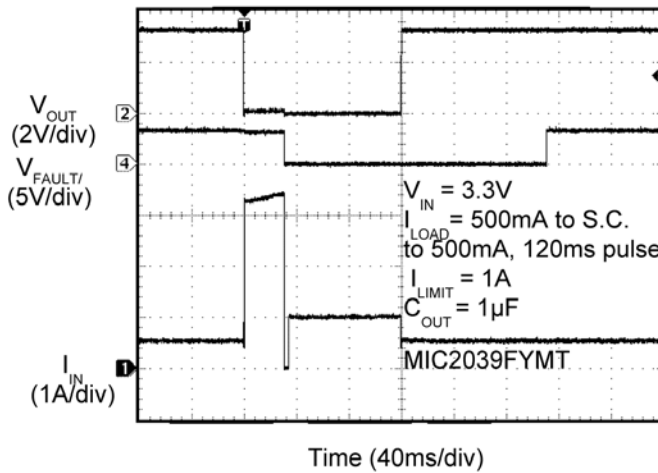

85ms Stepped Load Pulse - Kickstart

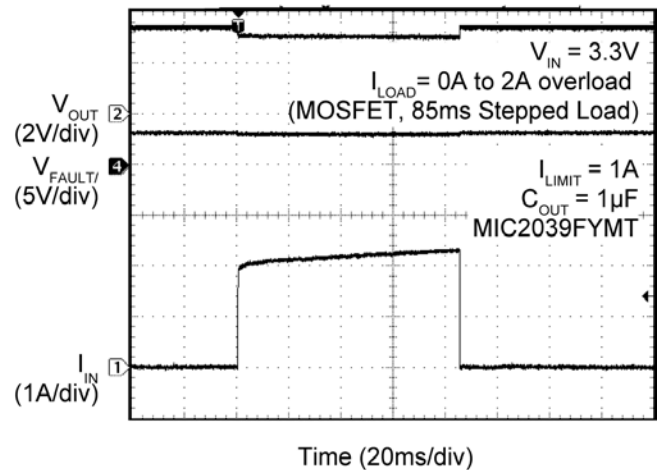

160ms Stepped Load Pulse - Kickstart

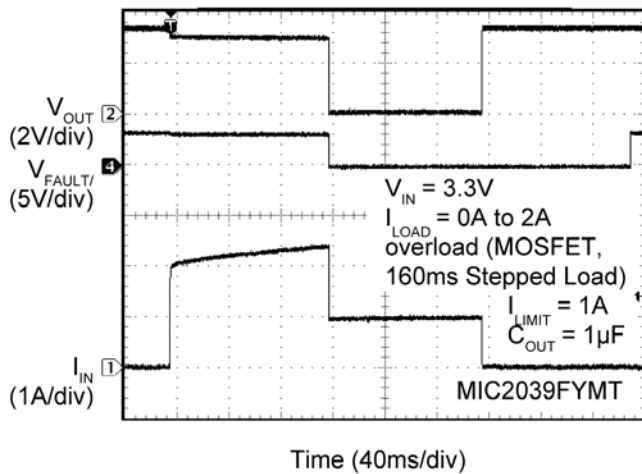

Output Thermal Shutdown & Recovery

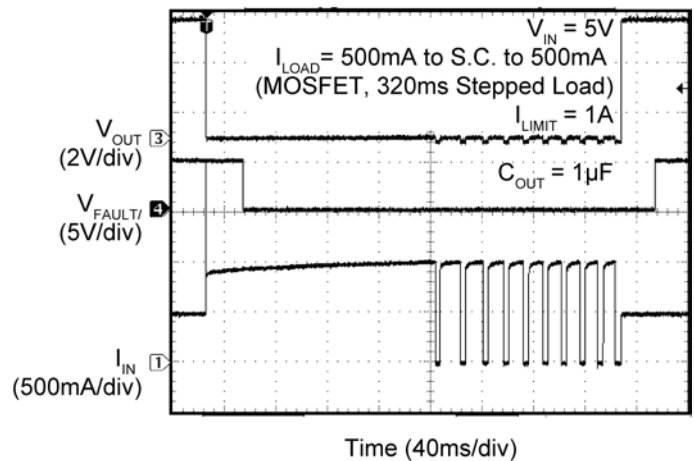

Functional Characteristics (Continued)

Output Thermal Shutdown & Recovery - Kickstart

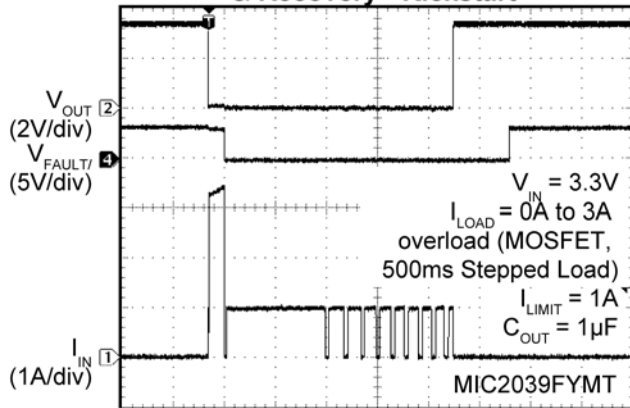

Time (100ms/div)

1.5A Overload Response

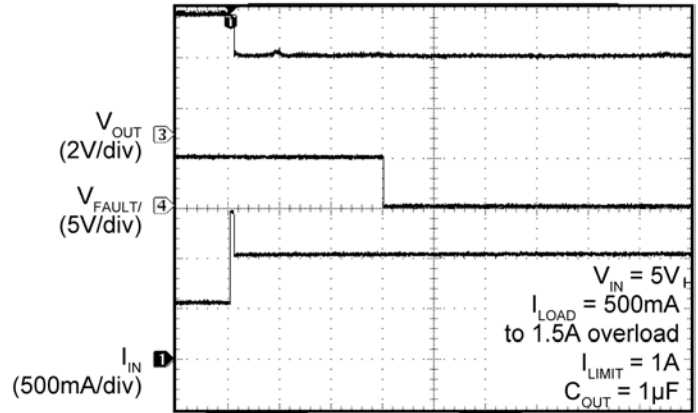

Time (10ms/div)

3A Overload Response - Kickstart

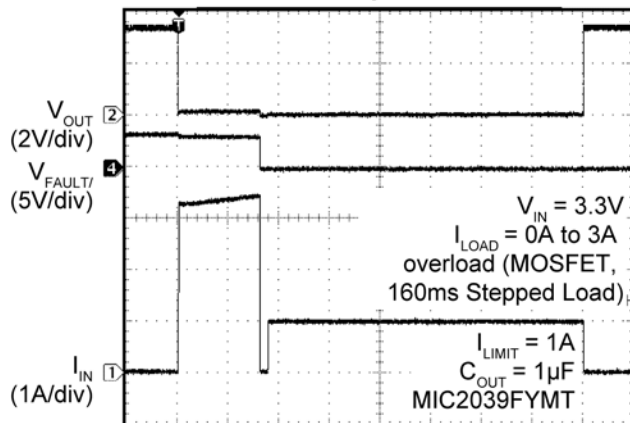

Time (20ms/div)

Turn-On Into 12% Overload - 500mA I_{LIMIT}

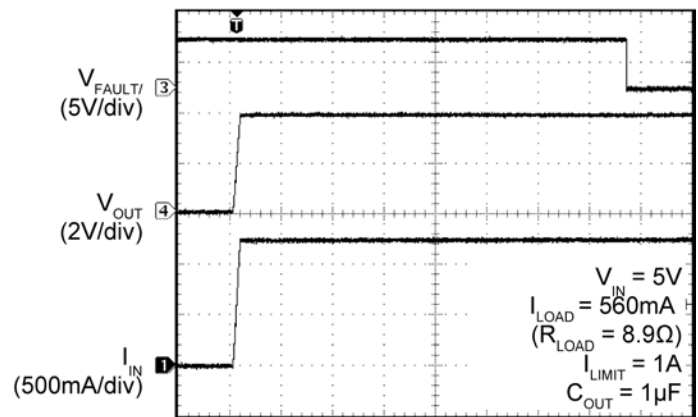

Time (4ms/div)

Turn-On Into 25% Overload - 1A I_{LIMIT}

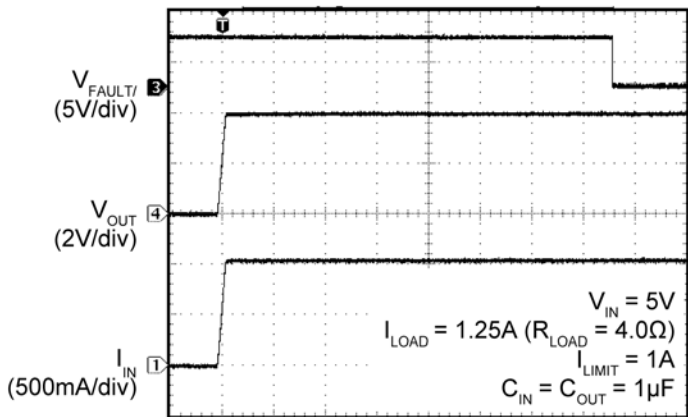

Time (4ms/div)

Turn-On Into Minimal Overload - 1.5A I_{LIMIT}

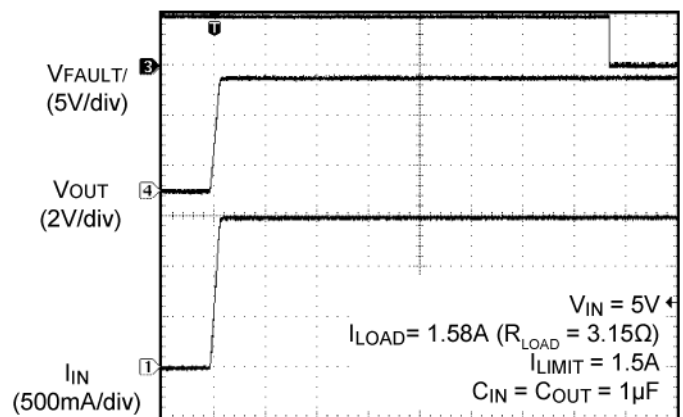

Time (4ms/div)

Functional Diagram

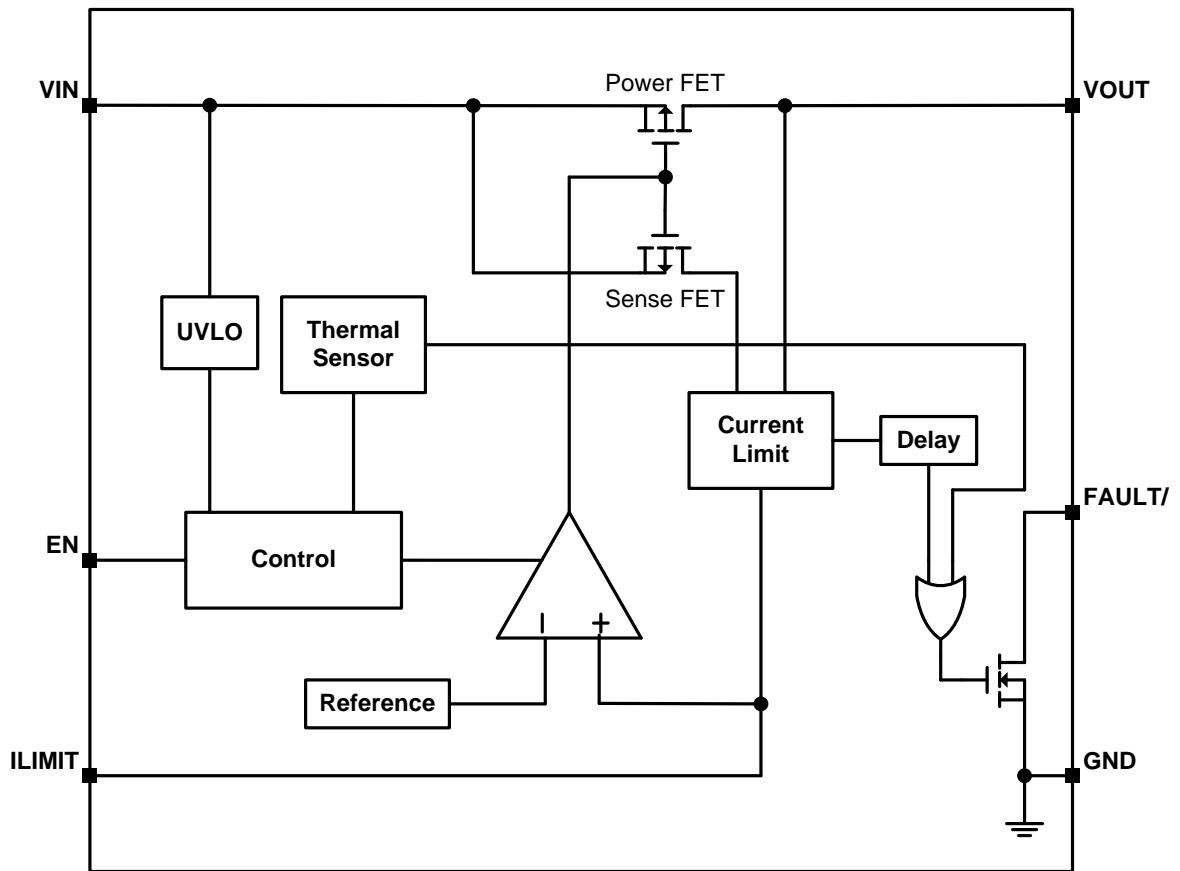

Figure 5. MIC2039 Block Diagram

Functional Description

The MIC2039 is a high-side MOSFET power-distribution switch that provides increased system reliability by using 5% current limit accuracy. The MIC2039 is internally current limited and has thermal shutdown, which protects the device and system.

The MIC2039 has a soft-start circuit that minimizes inrush current by slowing the turn-on time. Additionally, the MIC2039 has an optional Kickstart feature, which momentarily overrides the normal current-limiting function to allow higher inrush and/or transient currents.

Soft-Start

Soft-start reduces the power-supply input surge current at startup by controlling the output voltage rise time. The input surge appears while the output capacitor is charged up. A slower output rise time draws a lower input surge current.

KICKSTART Inrush Overcurrent Filter

The MIC2039EYxx and MIC2039FYxx are equipped with a secondary current limit that allows high inrush current transients to pass for a set period before the primary current-limit circuitry becomes active. The FAULT/ status flag does not assert during the Kickstart period (typically 120ms), which eliminates any false (FAULT/) assertions. The Kickstart function is active during initial startup or while operating in steady state.

Input Capacitor

Micrel recommends a 1 μ F to 10 μ F ceramic input capacitor for most applications.

Place the input capacitor on the same side of the board and next to the MIC2039 to minimize the voltage ringing during transient and short-circuit conditions. Using two vias for each end of the capacitor to connect to the power and ground plane is also recommended.

Micrel recommends X7R or X5R dielectric ceramic capacitors because of their temperature performance. X7R-type capacitors change capacitance by 15% over their operating temperature range and are the most stable type of ceramic capacitors. Z5U and Y5V dielectric capacitors change value by as much as 50% and 60%, respectively, over their operating temperature ranges. To use a ceramic chip capacitor with Y5V dielectric, the value must be much higher than an X7R ceramic or a tantalum capacitor to ensure the same capacitance value over the operating temperature range.

Output Capacitor

The output capacitor type and placement criteria are the same as for the input capacitor. See the "Input Capacitor" section for a detailed description.

Enable

The MIC2039 offers either an active-high or active-low enable input (EN) that allows ON/OFF control of the switch output. The current through the device reduces to near "zero" when the device is shut down, with only microamperes of leakage current. The EN input can be directly tied to V_{IN} or driven by a voltage that is equal to or less than V_{IN} ; do not leave this pin floating.

Adjustable Current Limit

The MIC2039 current limit is adjustable from 0.2A to 2.5A by connecting a resistor from the ILIMIT pin to GND. The following equation determines the resistor:

$$R_{LIMIT} \cong 289 / I_{LIMIT} \quad \text{Eq. 1}$$

where I_{LIMIT} is the typical current limit from the electrical table. If the output current exceeds the set current limit, the MIC2039 switch enters constant current limit mode. The maximum allowable current limit can be less than the full specified and/or expected current if the MIC2039 is not mounted on a circuit board with sufficiently low thermal resistance. Table 1 shows resistor values (1%) for select current limit settings.

I_{LIMIT}	0.2A	0.5A	1.0A	2A	2.5A
R_{LIMIT}	1.45k Ω	576 Ω	287 Ω	145 Ω	115 Ω

Table 1. Resistor Selection for Adjustable Current Limit

Thermal Design

To help reduce the thermal resistance, the ePad (underneath the IC) should be soldered to the PCB ground. The placement of thermal vias either underneath or near the ePad is highly recommended. Thermal design requires the following application-specific parameters:

- Maximum ambient temperature (T_A)
- Output current (I_{OUT})
- Input voltage (V_{IN})
- Current limit (I_{LIMIT})

When the MIC2039 is in constant current limit mode, it may exceed the overtemperature threshold. If this occurs, the overtemperature condition will shut down the MIC2039 switch and the fault status flag will go active (assert low). After the switch cools down, it automatically turns on again. The user can maximize the MIC2039 power dissipation by either lowering the thermal resistance on the exposed pad (only the DFN package has an exposed pad) on the printed circuit board, or by limiting the maximum allowable ambient temperature.

Thermal Measurements

It is always wise to measure the IC's case temperature to make sure that it is within its operating limits. Although this might seem like an elementary task, it is very easy to get false results. The most common mistake is to use the standard thermal couple that comes with the thermal voltage meter. This thermal couple wire gauge is large, typically 22 gauge, and behaves like a heatsink, resulting in a lower case measurement.

There are two suggested methods for measuring the IC case temperature: a thermal couple or an infrared thermometer. If a thermal couple is used, it must be constructed of 36 gauge wire or higher to minimize the wire heatsinking effect. In addition, the thermal couple tip must be covered in either thermal grease or thermal glue to make sure that the thermal couple junction is making good contact to the case of the IC. Thermal couple 5SC-TT-K-36-36 from Omega is adequate for most applications.

To avoid using messy thermal couple grease or glue, an infrared thermometer is recommended. Most infrared thermometers' spot size is too large for an accurate reading on small form factor ICs. However, an IR thermometer from Optris has a 1mm spot size, which makes it ideal for the 2mm × 2mm thin DFN package. Also, get the optional stand. The stand makes it easy to hold the beam on the IC for long periods of time.

Evaluation Board Schematic

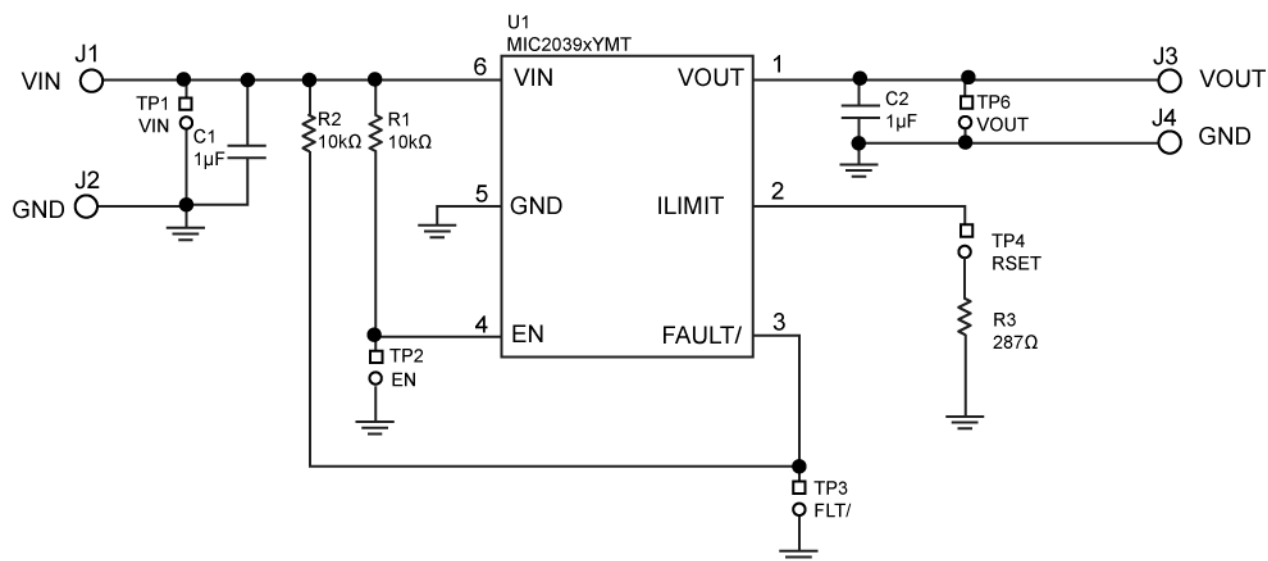

Bill of Materials

Item	Part Number	Manufacturer	Description	Qty.
C1, C2	C1608X5R0J105K	TDK ⁽⁹⁾	1µF/6.3V ceramic capacitor, X5R, 0603	2
	06036D105KAT2A	AVX ⁽¹⁰⁾		
R1, R2	CRCW060310K0FKEA	Vishay/Dale ⁽¹¹⁾	10kΩ, film resistor, 0603, 1%	2
R3	CRCW06032870FKEA	Vishay/Dale	287Ω film resistor, 0603, 1%	1
U1	MIC2039xYMT	Micrel ⁽¹²⁾	High-accuracy, high-side, adjustable current-limit power switch	1

Notes:

- 9. TDK: www.tdk.com.
- 10. AVX: www.avx.com.
- 11. Vishay: www.vishay.com.
- 12. Micrel, Inc.: www.micrel.com

PCB Layout (MIC2039xYMT Evaluation Board)

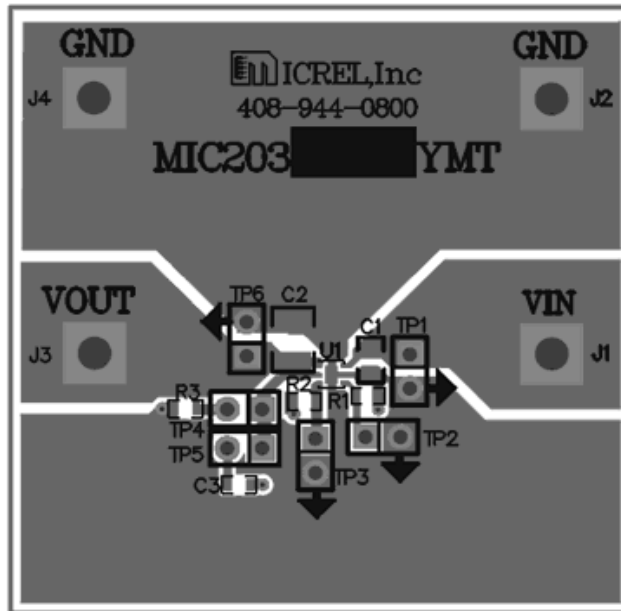

MIC2039xYMT Evaluation Board – Top Layer

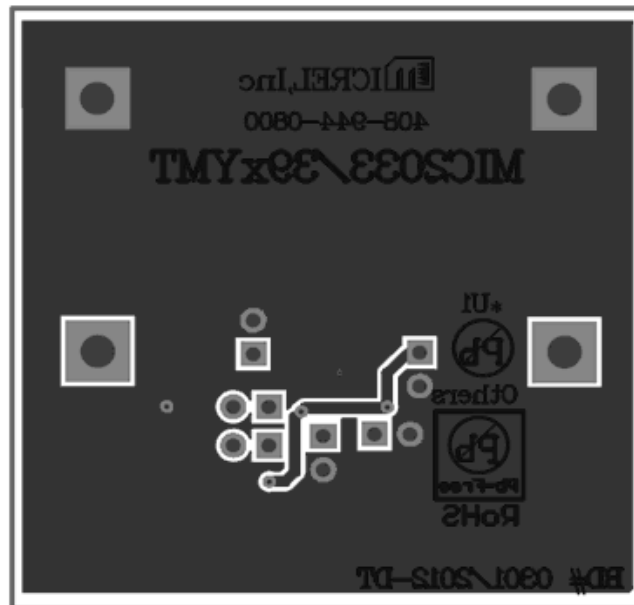

MIC2039xYMT Evaluation Board – Bottom Layer

PCB Layout (MIC2039xYM6 Evaluation Board)

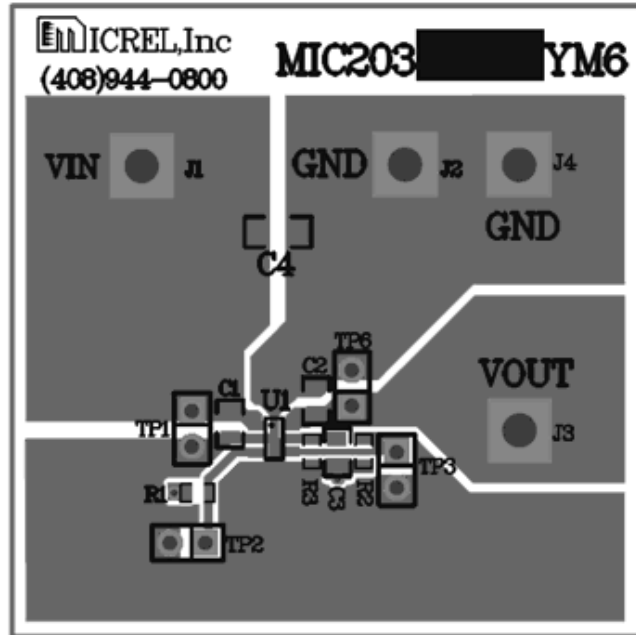

MIC2039xYM6 Evaluation Board – Top Layer

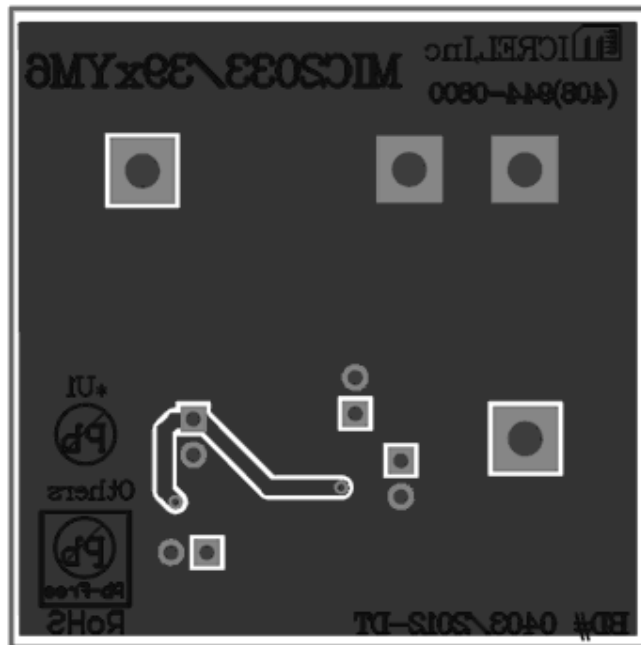

MIC2039xYM6 Evaluation Board – Bottom Layer

Package Information⁽¹³⁾

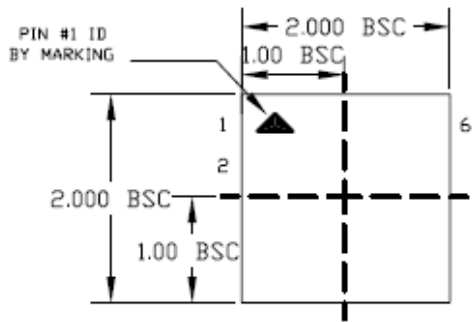

TOP VIEW

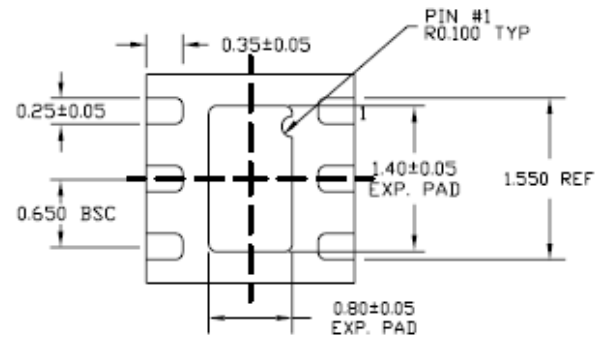

BOTTOM VIEW

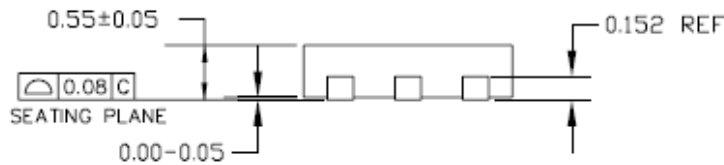

SIDE VIEW

6-Pin 2mm x 2mm Thin DFN (MT)

Note:

13. Package information is correct as of the publication date. For updates and most current information, go to www.micrel.com.

Package Information⁽¹³⁾ (Continued)

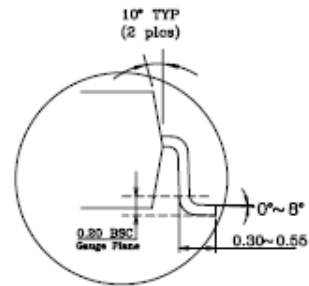
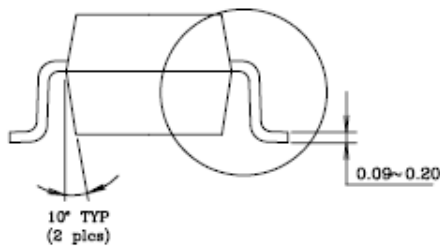
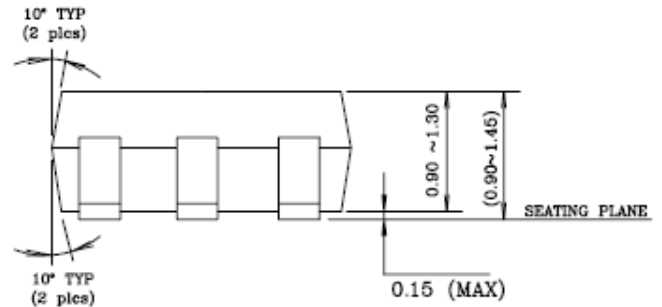
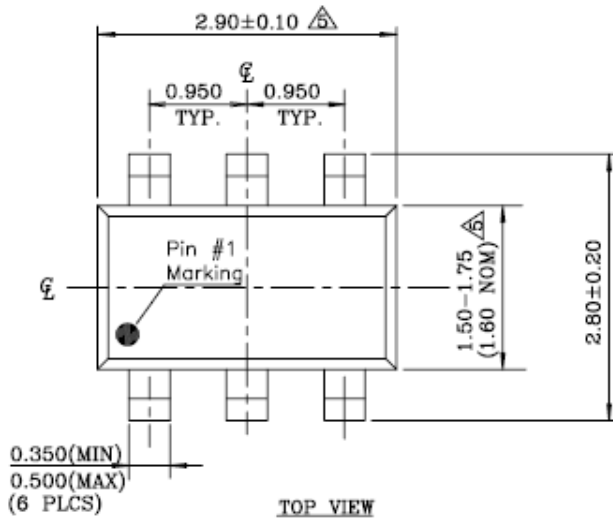

NOTE:

1. Dimensions and tolerances are as per ANSI Y14.5M, 1982.
 2. Package surface to be mirror finish.
 3. Die is facing up for mold. Die is facing down for trim/form, ie. reverse trim/form.
 4. The footlength measuring is based on the gauge plane method.
- △ Dimension are exclusive of mold flash & gate burr.

SOT23-6L (M6)

MICREL, INC. 2180 FORTUNE DRIVE SAN JOSE, CA 95131 USATEL +1 (408) 944-0800 FAX +1 (408) 474-1000 WEB <http://www.micrel.com>

Micrel makes no representations or warranties with respect to the accuracy or completeness of the information furnished in this data sheet. This information is not intended as a warranty and Micrel does not assume responsibility for its use. Micrel reserves the right to change circuitry, specifications and descriptions at any time without notice. No license, whether express, implied, arising by estoppel or otherwise, to any intellectual property rights is granted by this document. Except as provided in Micrel's terms and conditions of sale for such products, Micrel assumes no liability whatsoever, and Micrel disclaims any express or implied warranty relating to the sale and/or use of Micrel products including liability or warranties relating to fitness for a particular purpose, merchantability, or infringement of any patent, copyright or other intellectual property right

Micrel Products are not designed or authorized for use as components in life support appliances, devices or systems where malfunction of a product can reasonably be expected to result in personal injury. Life support devices or systems are devices or systems that (a) are intended for surgical implant into the body or (b) support or sustain life, and whose failure to perform can be reasonably expected to result in a significant injury to the user. A Purchaser's use or sale of Micrel Products for use in life support appliances, devices or systems is a Purchaser's own risk and Purchaser agrees to fully indemnify Micrel for any damages resulting from such use or sale.

© 2012 Micrel, Incorporated.



Стандарт Электрон Связь

Мы молодая и активно развивающаяся компания в области поставок электронных компонентов. Мы поставляем электронные компоненты отечественного и импортного производства напрямую от производителей и с крупнейших складов мира.

Благодаря сотрудничеству с мировыми поставщиками мы осуществляем комплексные и плановые поставки широчайшего спектра электронных компонентов.

Собственная эффективная логистика и склад в обеспечивает надежную поставку продукции в точно указанные сроки по всей России.

Мы осуществляем техническую поддержку нашим клиентам и предпродажную проверку качества продукции. На все поставляемые продукты мы предоставляем гарантию .

Осуществляем поставки продукции под контролем ВП МО РФ на предприятия военно-промышленного комплекса России , а также работаем в рамках 275 ФЗ с открытием отдельных счетов в уполномоченном банке. Система менеджмента качества компании соответствует требованиям ГОСТ ISO 9001.

Минимальные сроки поставки, гибкие цены, неограниченный ассортимент и индивидуальный подход к клиентам являются основой для выстраивания долгосрочного и эффективного сотрудничества с предприятиями радиоэлектронной промышленности, предприятиями ВПК и научно-исследовательскими институтами России.

С нами вы становитесь еще успешнее!

Наши контакты:

Телефон: +7 812 627 14 35

Электронная почта: sales@st-electron.ru

Адрес: 198099, Санкт-Петербург,
Промышленная ул, дом № 19, литера Н,
помещение 100-Н Офис 331