

General Description

The MAX13253 evaluation kit (EV kit) is a fully assembled and tested PCB that demonstrates the MAX13253 low-EMI push-pull transformer driver. The EV kit operates from a single 3.0V to 5.5V supply and the on-board 1CT:1.3CT turns-ratio transformer sets the output voltage.

The EV kit provides up to 90% overall efficiency at 5V with up to 4.5W output power using a push-pull isolated DC-DC converter. Undervoltage lockout, current limiting, and thermal shutdown provide for a robust isolated supply. The surface-mount transformer provides galvanic isolation with the output powered from a push-pull rectifier circuit, reducing the output-voltage ripple.

The EV kit circuit is configured as a push-pull rectifier, with an output voltage that follows the input voltage. The EV kit is also configurable for other topologies including bipolar outputs and full-wave rectification.

Features and Benefits

- 3.0V to 5.5V Operating Voltage Range
- Up to 90% Efficiency
- Push-Pull Rectified Output
- Configurable Bipolar Outputs or Full-Wave Rectifier
- Internal or External Clock Operation
- Selectable Spread-Spectrum Option for Controlled EMI
- Proven PCB Layout
- Fully Assembled and Tested

Ordering Information appears at end of data sheet.

Component List

DESIGNATION	QTY	DESCRIPTION
C1, C2	2	1 μ F \pm 10%, 25V X7R ceramic capacitors (0603) Murata GRM188R71E105K
C3, C5	2	10 μ F \pm 10%, 25V X7R ceramic capacitors (1206) Murata GRM31CR71E106K
C4	0	Not installed, ceramic capacitor (1206)
D1	1	Red LED (1206)
D2, D3	2	30V, 2A Schottky diodes (SMA) Diodes Inc. B230A-13-F
D4, D5	0	Not installed, Schottky diodes (SMA)
J1, J3, J4	3	3-pin headers

DESIGNATION	QTY	DESCRIPTION
J2, J5	2	2-pin headers
R1	1	560 Ω \pm 5% resistor (0603)
R2	1	0 Ω \pm 5% resistor (0603)
R3	1	1k Ω \pm 5% resistor (0603)
TX1	1	1CT:1.3CT turns-ratio transformer (8 Gull Wing) Halo TGM-H240V8LF
U1	1	1A spread-spectrum push-pull transformer driver (10 TDFN-EP*) Maxim MAX13253ATB+
—	5	Shunts
—	1	PCB: MAX13253 EVALUATION KIT

*EP = Exposed pad.

Component Suppliers

SUPPLIER	PHONE	WEBSITE
Diodes Incorporated	972-987-3900	www.diodes.com
Halo Electronics, Inc.	650-903-3800	www.haloelectronics.com
Murata Electronics, North America, Inc.	770-436-1300	www.murata-northamerica.com

Note: Indicate that you are using the MAX13253 when contacting these component suppliers.

Quick Start

Required Equipment

- MAX13253 EV kit
- 5.0V, 2A DC power supply
- Electronic load capable of 1A
- Ammeter
- Voltmeter

Procedure

The EV kit is fully assembled and tested. Follow the steps below to verify board operation. **Caution: Do not turn on the power supply until all connections are completed.**

- 1) Verify that jumpers J1–J5 are in their default positions, as shown in Table 1.
- 2) Set the DC power supply to 5.0V.
- 3) Set the electronic load to 500mA and disable the output.
- 4) Connect the voltmeter between the +VOUT and SGND PCB pads on the EV kit.
- 5) Connect the ammeter between the +VOUT PCB pad on the EV kit and the positive terminal on the electronic load. The negative terminal on the electronic load is connected to the SGND PCB pad on the EV kit.
- 6) Connect the power supply between the VDD and GND PCB pads on the EV kit.
- 7) Turn on the power supply.
- 8) Enable the electronic load.
- 9) Verify that the ammeter reads approximately 500mA.

- 10) Verify that the voltmeter reads approximately 5.5V.

Detailed Description

The MAX13253 EV kit is a low-EMI, isolated push-pull DC-DC converter that provides an unregulated output with respect to the isolated ground. The maximum load is limited by the device and winding ratio of the transformer.

The device is an integrated primary-side controller and push-pull driver for isolated power-supply circuits. The device contains an on-board oscillator, protection circuitry, and internal MOSFETs to provide up to 1A of current to the transformer’s primary winding. The device can be operated using the internal pin-selectable oscillator, or driven by an external clock to synchronize multiple devices.

The device operates from a single-supply voltage and includes UVLO and an active-low enable input for controlled startup. If the input voltage at VDD falls below 2.55V, or the EN input is pulled above 2.0V, the device shuts down and T1 and T2 are high impedance.

Clock Source

The device has two modes of operation, internal oscillator or external clock.

Using the Internal Oscillator and Spread-Spectrum Functionality

The device includes an internal oscillator with a guaranteed 50% duty cycle. To use the internal oscillator, place a shunt across pins 1-2 on jumper J2. Place a shunt across pins 1-2 on jumper J3 to set the T1/T2 switching frequency to 600kHz (typ). Place a shunt across pins 2-3 on J3 to set the T1/T2 switching frequency to 250kHz (typ).

Table 1. Jumper Description Table

JUMPER	SHUNT POSITION	DESCRIPTION
J1	1-2	$\overline{\text{EN}}$ connected to VDD.
	2-3*	$\overline{\text{EN}}$ connected to GND. Device enabled.
J2	Installed*	CLK connected to GND. Internal oscillator enabled.
	Not installed	CLK open. External oscillator enabled. Apply a clock signal to the CLK PCB pad on the EV kit.
J3	1-2	HICLK connected to VDD. T1/T2 switch at 600kHz.
	2-3*	HICLK connected to GND. T1/T2 switch at 250kHz.
J4	1-2	SPRD connected to VDD. Spread-spectrum functionality enabled.
	2-3*	SPRD connected to GND. Spread-spectrum functionality disabled.
J5	Not installed*	+VOUT is not shorted to SGND.
	Installed	+VOUT is shorted to SGND.

*Default position.

The device features pin-selectable spread-spectrum functionality on the internal oscillator for controlled EMI. Use jumper J4 on the EV kit to enable or disable the spread-spectrum functionality when the internal oscillator is enabled. Place a shunt across pins 1-2 on J4 to enable the ±4% frequency spread on the internal oscillator. Place a shunt across pins 2-3 or leave J4 open to disable spread spectrum.

Using the External Oscillator

When using the external clock, remove the shunt from J2 and apply a clock signal on the CLK PCB pad on the EV kit. An internal flip-flop divides the external clock by two, generating a switching signal with a guaranteed 50% duty cycle. As a result, the T1/T2 outputs switch at one-half the external clock frequency.

Overcurrent Limiting

The device features overcurrent limiting to protect the IC from excessive currents when charging large capacitive loads or driving into short circuits. Current limiting is achieved in two stages: internal circuitry monitors the driver output current and detects when the peak current rises above 2A. When the 2A limit is exceeded, internal protection circuitry is immediately enabled, reducing the output current and regulating it to the 1.4A (typ) current-limit threshold. The device monitors the driver current on a cycle-by-cycle basis, and the driver output current is regulated to the current-limit threshold until the short is removed.

The device can dissipate large amounts of power during overcurrent limiting, causing the IC to enter thermal shutdown. Ensure that the expected maximum operating current is less than 1A for continuous operation.

Evaluating Other Transformer Configurations

The EV kit PCB layout provides an easy method to reconfigure transformer TX1 secondary windings for other configurations, including bipolar outputs and full-wave rectifier. Use Table 2 to reconfigure the EV kit for the appropriate output configuration.

Using the MAX13253EVKIT with Other Transformers

The EV kit comes with the 1CT:1.3CT TGM-H240V8LF transformer from Halo Electronics installed on TX1, but the EV kit can also be used with other transformers. Table 3 is a list of available transformers from Halo Electronics designed for the MAX13253 that have other winding-ratios and/or higher isolation ratings. Contact Halo Electronics to obtain samples of any of these transformers.

Note that the EV kit is designed for 4500VRMS isolation operation, with 600 mils (15.24mm) spacing between the primary ground (GND) and secondary ground (SGND) planes. Test points GND and SGND are provided on the PCB for probing the respective ground planes, or to connect the GND and SGND planes together for non-isolated evaluation of the circuit.

Table 2. Output Configurations

CONFIGURATION	D2	D3	D4	D5	C3	C4	R2
Full-wave rectifier	Installed	Installed	Installed	Installed	Installed	0Ω resistor	Not installed
Bipolar outputs	Installed	Installed	Installed	Installed	Installed	Installed	Installed
Push-pull rectifier*	Installed	Installed	Not installed	Not installed	Installed	Not installed	0Ω

*Default position.

Table 3. Available Transformers for the MAX13253

PART	TURNS RATIO	ISOLATION VOLTAGE
TGM-H240V8LF	1CT:1.3CT	1500V _{RMS}
TGM-H260V8LF	1CT:2CT	1500V _{RMS}
TGM-H280V8LF	1CT:2.67CT	1500V _{RMS}
TGMR-H540V8LF	1CT:1.375CT	4500V _{RMS}
TGMR-H560V8LF	1CT:2CT	4500V _{RMS}
TGMR-H580V8LF	1CT:2.67CT	4500V _{RMS}

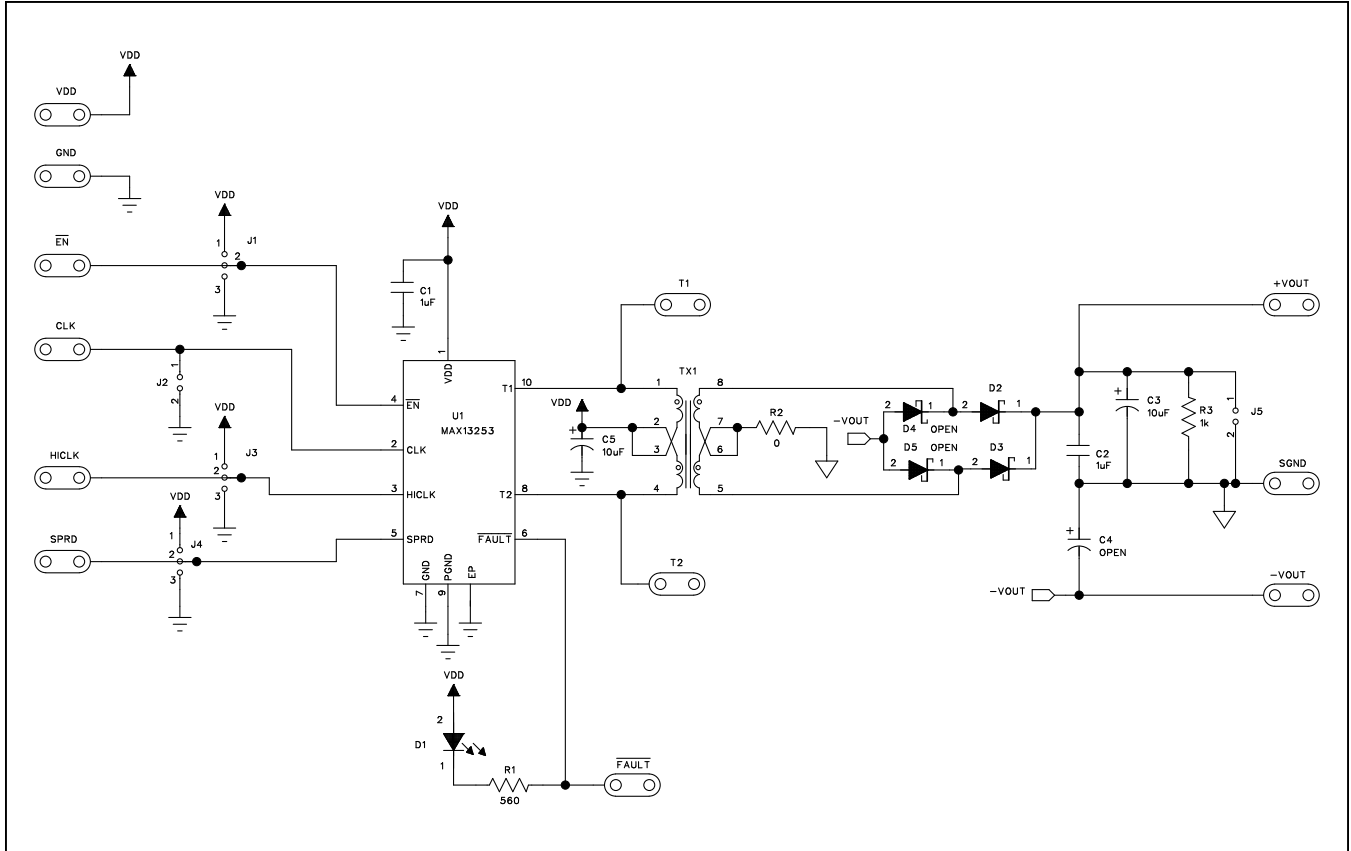

Figure 1. MAX13253 EV Kit Schematic

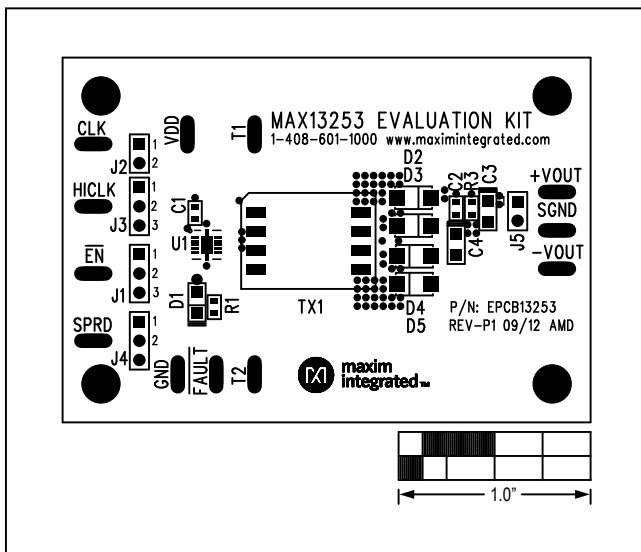

Figure 2. MAX13253 EV Kit Component Placement Guide—Component Side

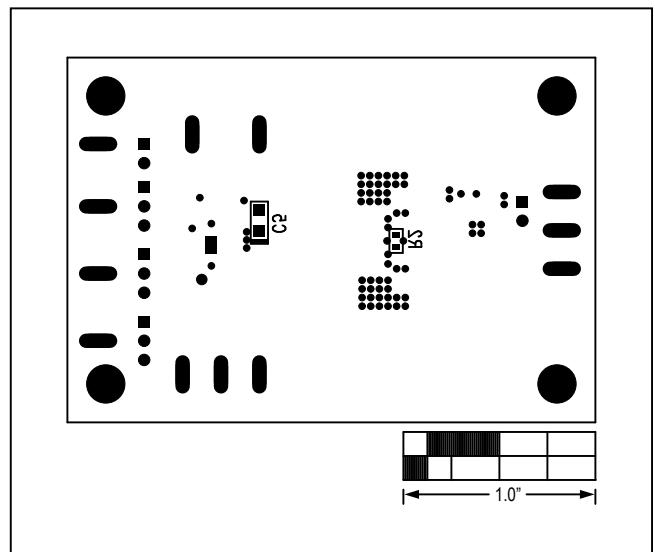

Figure 3. MAX13253 EV Kit Component Placement Guide—Solder Side

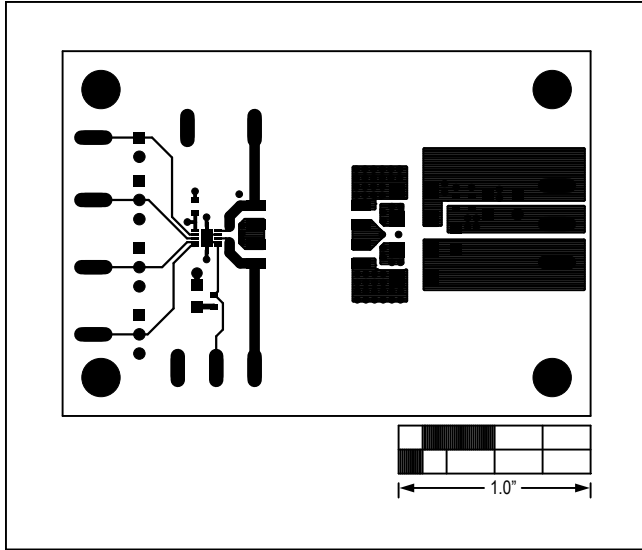

Figure 4. MAX13253 EV Kit PCB Layout—Component Side

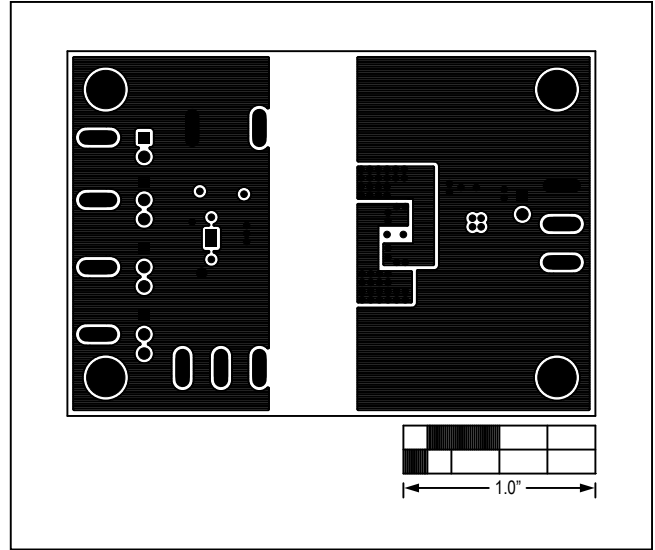

Figure 6. MAX13253 EV Kit PCB Layout—PWR

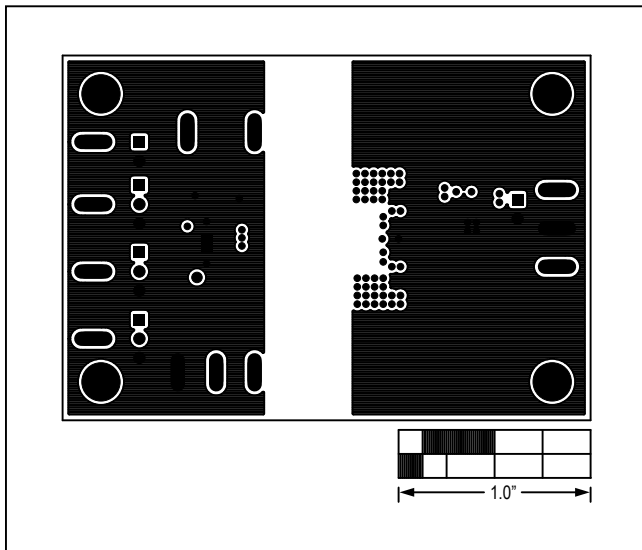

Figure 5. MAX13253 EV Kit PCB Layout—GND

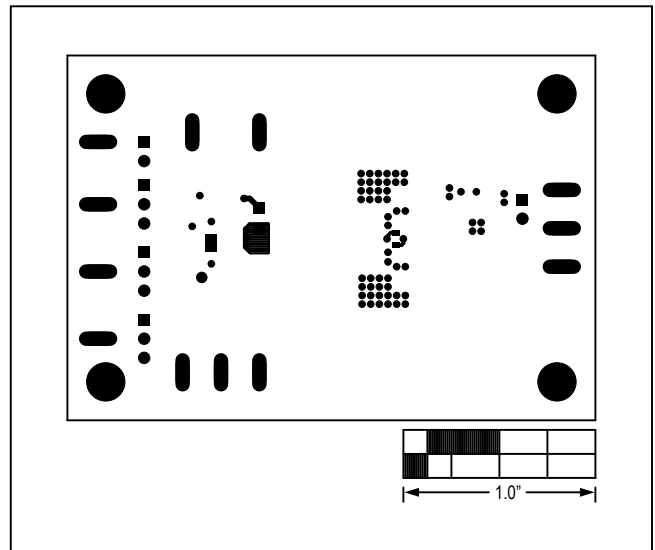

Figure 7. MAX13253 EV Kit PCB Layout—Solder Side

Ordering Information

PART	TYPE
MAX13253EVKIT#	EV Kit

#Denotes RoHS compliant.

Revision History

REVISION NUMBER	REVISION DATE	DESCRIPTION	PAGES CHANGED
0	3/13	Initial release	—

For pricing, delivery, and ordering information, please contact Maxim Direct at 1-888-629-4642, or visit Maxim Integrated's website at www.maximintegrated.com.

Maxim Integrated cannot assume responsibility for use of any circuitry other than circuitry entirely embodied in a Maxim Integrated product. No circuit patent licenses are implied. Maxim Integrated reserves the right to change the circuitry and specifications without notice at any time.



Стандарт Электрон Связь

Мы молодая и активно развивающаяся компания в области поставок электронных компонентов. Мы поставляем электронные компоненты отечественного и импортного производства напрямую от производителей и с крупнейших складов мира.

Благодаря сотрудничеству с мировыми поставщиками мы осуществляем комплексные и плановые поставки широчайшего спектра электронных компонентов.

Собственная эффективная логистика и склад в обеспечивает надежную поставку продукции в точно указанные сроки по всей России.

Мы осуществляем техническую поддержку нашим клиентам и предпродажную проверку качества продукции. На все поставляемые продукты мы предоставляем гарантию .

Осуществляем поставки продукции под контролем ВП МО РФ на предприятия военно-промышленного комплекса России , а также работаем в рамках 275 ФЗ с открытием отдельных счетов в уполномоченном банке. Система менеджмента качества компании соответствует требованиям ГОСТ ISO 9001.

Минимальные сроки поставки, гибкие цены, неограниченный ассортимент и индивидуальный подход к клиентам являются основой для выстраивания долгосрочного и эффективного сотрудничества с предприятиями радиоэлектронной промышленности, предприятиями ВПК и научно-исследовательскими институтами России.

С нами вы становитесь еще успешнее!

Наши контакты:

Телефон: +7 812 627 14 35

Электронная почта: sales@st-electron.ru

Адрес: 198099, Санкт-Петербург,
Промышленная ул, дом № 19, литера Н,
помещение 100-Н Офис 331