

**Description**

The APX4558 device is a dual low noise operational amplifier. The wide bandwidth and low noise make it very suited to audio applications.

The device is short-circuit protected, and the internal frequency compensation ensures stability without external components.

**Pin Assignments**

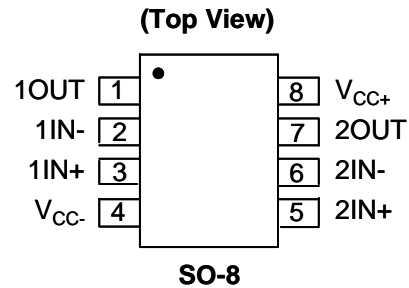

**Features**

- Unity-Gain Bandwidth . . . 3 MHz typical
- Gain and Phase match between amplifiers
- Low Noise . . . 8 nV/ $\sqrt{\text{Hz}}$  typical at 1 kHz
- Wide Common-Mode and Differential voltage ranges
- No frequency compensation required
- Low power consumption
- No latch-up
- Green mold compound (No Br, Sb) (Note 1)

**Applications**

- Audio pre amps
- RCA line out buffers

Notes: 1. EU Directive 2002/95/EC (RoHS). All applicable RoHS exemptions applied. Please visit our website at [http://www.diodes.com/products/lead\\_free.html](http://www.diodes.com/products/lead_free.html).

**Schematic Diagram**

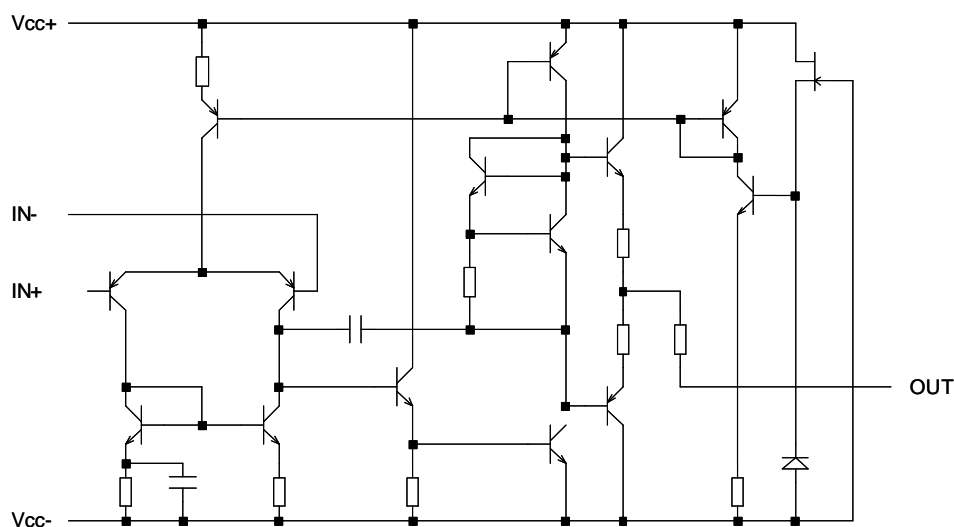

### Pin Descriptions

Pin #	Name	Description
1	1OUT	Amplifier 1 output
2	1IN-	Amplifier 1 inverting input
3	1IN+	Amplifier 1 non-inverting input
4	V <sub>CC-</sub>	Negative supply pin for amplifier 1 and amplifier 2
5	2IN+	Amplifier 2 non-inverting input
6	2IN-	Amplifier 2 inverting input
7	2OUT	Amplifier 2 output
8	V <sub>CC+</sub>	Positive supply pin for amplifier 1 and amplifier 2.

### Absolute Maximum Ratings (Note 2)

Symbol	Parameter	Rating	Unit
V <sub>CC+</sub>	Supply voltage (Note 3)	18	V
V <sub>CC-</sub>		-18	
V <sub>ID</sub>	Differential input voltage (Note 4)	±30	V
V <sub>I</sub>	Input voltage (any input) (Note 3, 5)	±15	V
	Duration of output short circuit to ground, one amplifier at a time (Note 6)	Unlimited	
T <sub>J</sub>	Junction Temperature (Note 7)	150	°C
T <sub>STG</sub>	Storage Temperature	-65 to 150	°C

- Notes:
- Stresses beyond those listed under Absolute Maximum Ratings may cause permanent damage to the device. These are stress ratings only, and functional operation of the device at these or any other conditions beyond those indicated under Recommended Operating Conditions is not implied. Exposure to absolute-maximum-rated conditions for extended periods may affect device reliability.
  - All voltage values, unless otherwise noted, are with respect to the midpoint between V<sub>CC+</sub> and V<sub>CC-</sub>.
  - Differential voltages are at IN+ with respect to IN-.
  - The magnitude of the input voltage must never exceed the magnitude of the supply voltage or 15 V, whichever is less.
  - Temperature and/or supply voltages must be limited to ensure that the dissipation rating is not exceeded.
  - Maximum power dissipation is a function of T<sub>J</sub> (max), θ<sub>JA</sub>, and T<sub>A</sub>. The maximum allowable power dissipation at any allowable ambient temperature is P<sub>D</sub> = (T<sub>J</sub> (max) - T<sub>A</sub>)/θ<sub>JA</sub>. Operating at the absolute maximum T<sub>J</sub> of 150°C can affect reliability.

### Recommended Operating Conditions

Symbol	Parameter		Min	Max	Unit
V <sub>CC+</sub>	Supply voltage (Note 3)		5	15	V
V <sub>CC-</sub>			-5	-15	
T <sub>A</sub>	Operating Ambient Temperature Range	APX4558	0	70	°C
		APX4558I	-40	105	

### Electrical Characteristics ( $V_{CC\pm} = \pm 15V$ , $T_A = 25C$ , unless otherwise stated)

Symbol	Parameter	Conditions	$T_A$	Min	Typ.	Max	Unit
<b>AC Characteristics</b>							
$V_{IO}$	Input offset voltage	$V_O = 0V$	25°C		0.5	6	mV
			Full temp			7.5	
$I_{IO}$	Input offset current	$V_O = 0V$	25°C		5	200	nA
			Full temp			300	
$I_{IB}$	Input bias current	$V_O = 0V$	25°C		150	500	nA
			Full temp			800	
$V_{ICR}$	Common-mode input voltage range		25°C	$\pm 12$	$\pm 14$		V
$V_{OM}$	Maximum output voltage swing	$R_L = 10k\Omega$	25°C	$\pm 12$	$\pm 14$		V
			25°C	$\pm 10$	$\pm 13$		
			Full temp	$\pm 10$			
$A_{VD}$	Large-signal differential voltage amplification	$R_L \geq 2k\Omega$ $V_O = \pm 10V$	25°C	20	300		V/mV
			Full temp	15			
$R_{IN}$	Input resistance		25°C	0.3	5		M $\Omega$
CMRR	Common-mode rejection ratio	$V_{IN} = V_{ICR(Min)}$	25°C	70	90		dB
PSRR	Power supply rejection ratio	$V_{CC\pm} = \pm 15V$ to $\pm 9V$	25°C	76	90		dB
$I_{CC}$	Supply current both amplifiers	$V_O = 0V$ , No load	25°C		2.5	5.6	mA
			$T_A$ min		3	6.6	
			$T_A$ max		2.3	5	
<b>AC Characteristics</b>							
$B_1$	Unity-gain bandwidth		25°C		3		MHz
SR	Slew rate at unity gain	$V_I = \pm 10V$ , $R_L = 2k\Omega$ , $C_L = 100pF$	25°C	1.1	1.7		V/ $\mu s$
$v_n$	Equivalent input noise voltage (closed loop)	$G=100$ , $R_S = 100\Omega$ $F = 1kHz$ , $BW = 1Hz$	25°C		8		nV/ $\sqrt{Hz}$
$V_{O1}/V_{O2}$	Crosstalk attenuation	Open loop $G = 100$	25°C		$R_S = 1k\Omega$	85	dB
					$f = 10kHz$	105	
$t_r$	Rise time overshoot	$V_I = 20mV$ , $R_L = 2k\Omega$ , $C_L = 100pF$	25°C		0.13		$\mu s$
			25°C		5		%
<b>Power and Thermal Characteristics</b>							
$P_D$	Total power dissipation both amplifiers	$V_O = 0V$ , No load	25°C		75	170	mW
			$T_A$ min		90	200	
			$T_A$ max		70	150	
$\theta_{JA}$	Thermal Resistance Junction-to-Ambient	SO-8 (Note 8)			130		°C/W
$\theta_{JC}$	Thermal Resistance Junction-to-Case	SO-8 Note 8)			15		°C/W

Notes: 8. Test condition for SO-8: Device mounted on FR-4 substrate PC board, with minimum recommended pad layout  
9. Full temp is specified as 0 to 70°C for the APX4558 and -40 to 105°C for the APX48558I

**Typical Performance Characteristics**

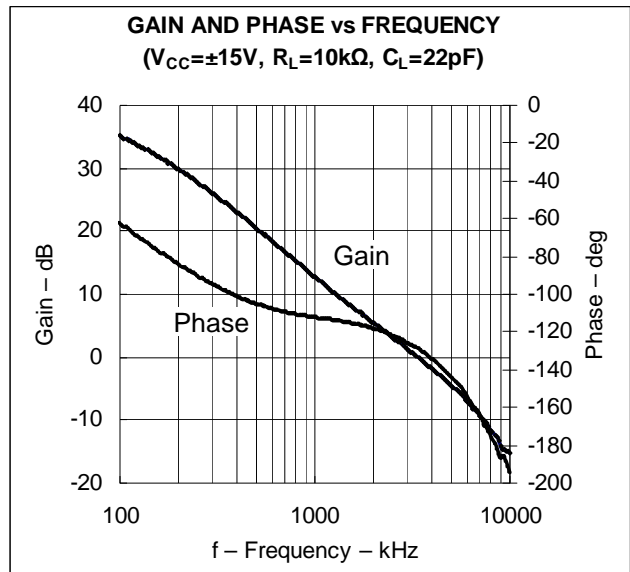
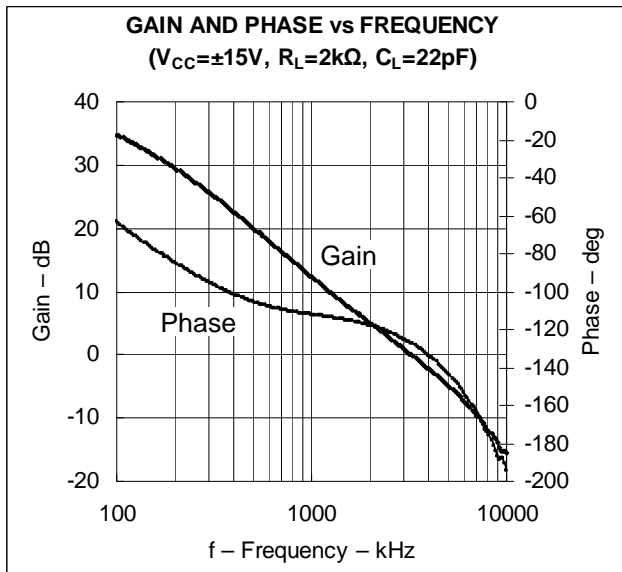
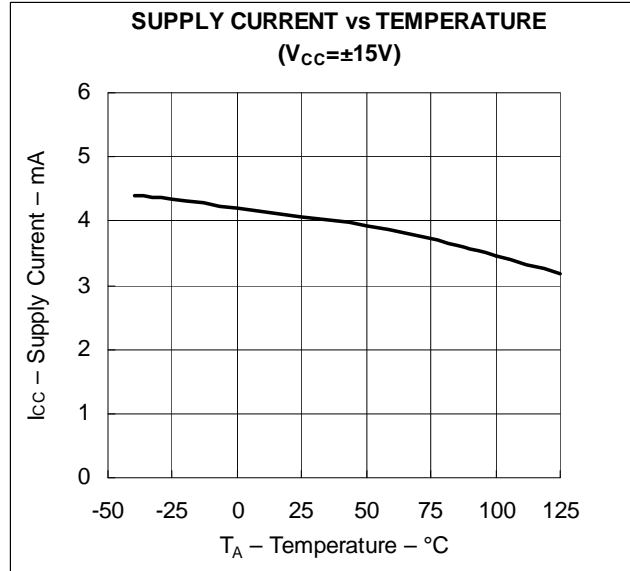
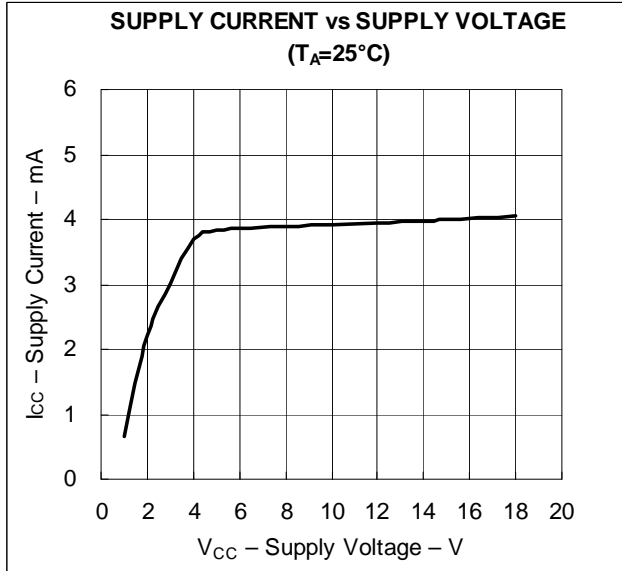

**Typical Performance Characteristics (Continued)**

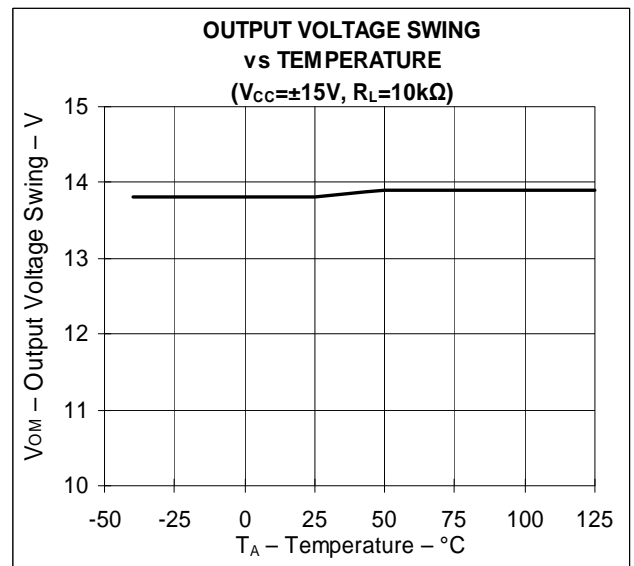
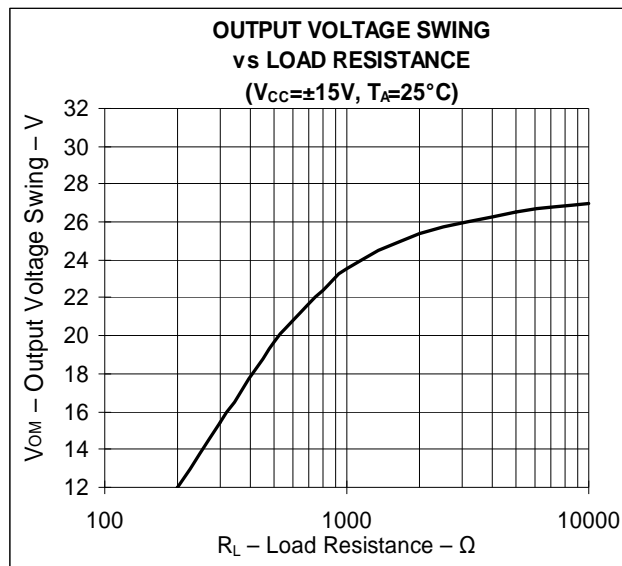
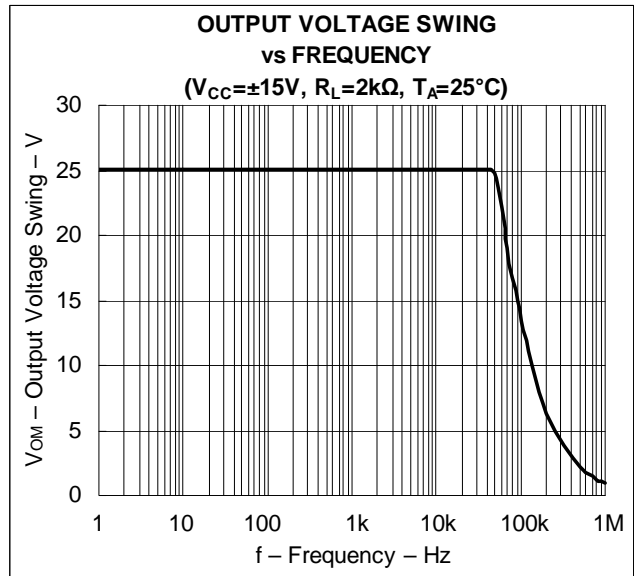
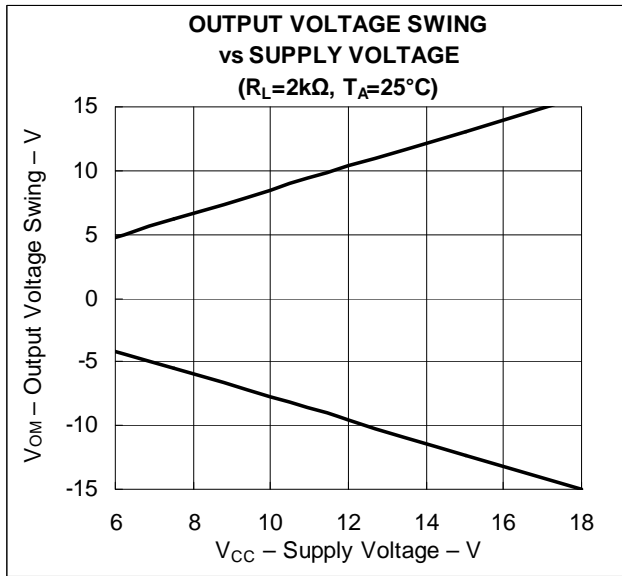

**Typical Performance Characteristics (Continued)**

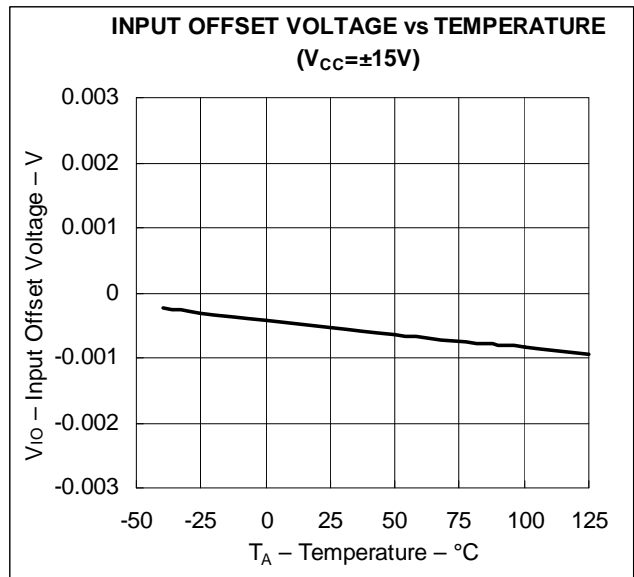
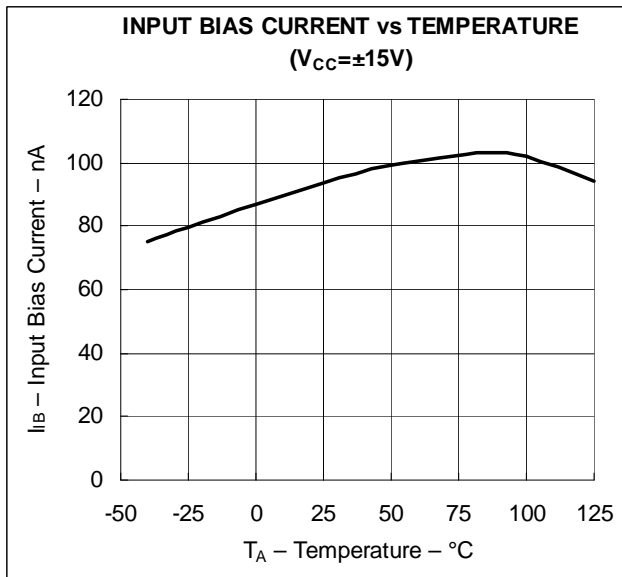
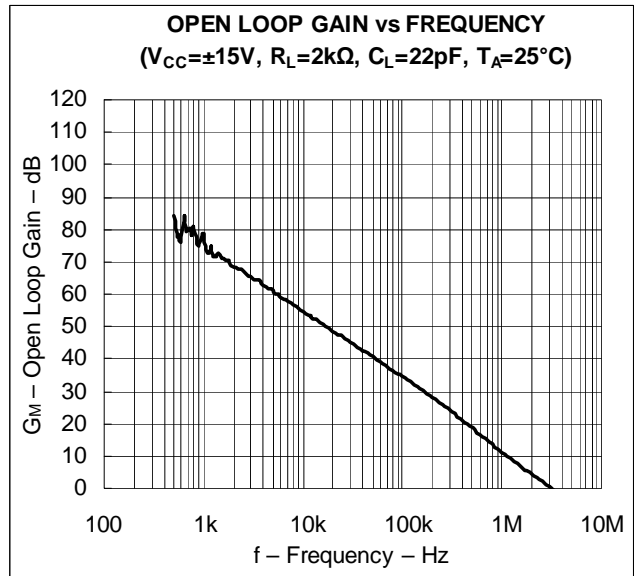
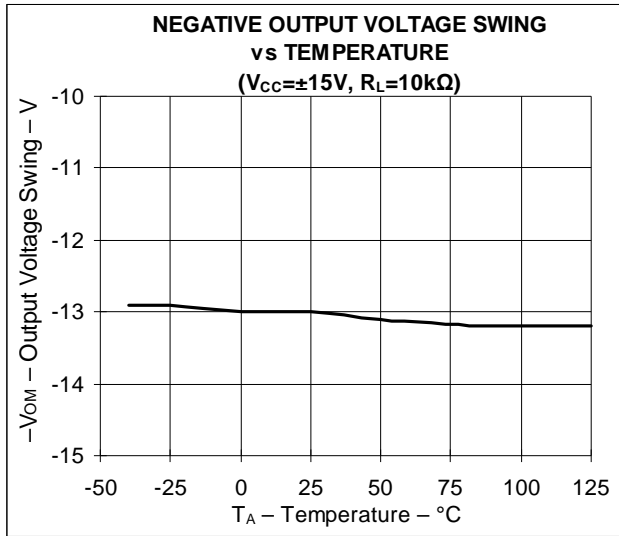

**Typical Performance Characteristics (Continued)**

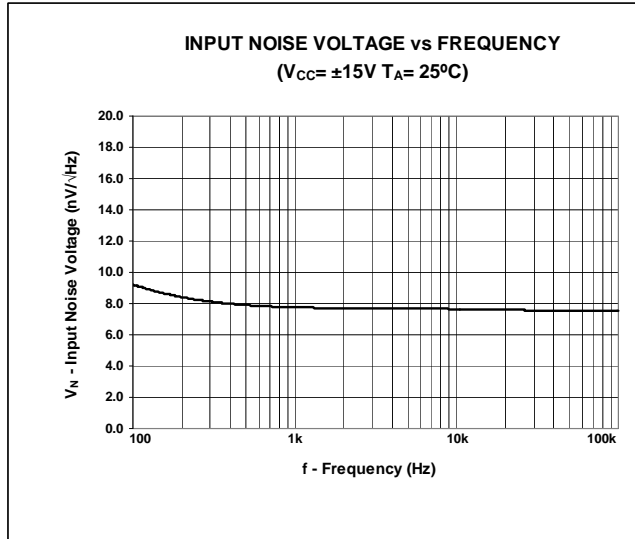

NEW PRODUCT

**Ordering Information**

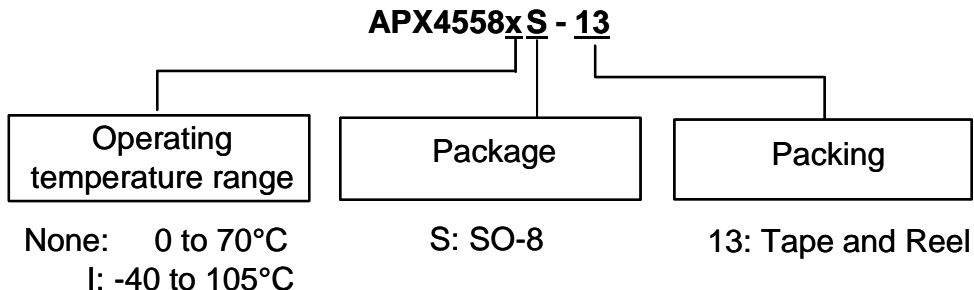

Device	Package Code	Packaging (Note 10)	13" Tape and Reel	
			Quantity	Part Number Suffix
APX4558S-13	S	SO-8	2500/Tape & Reel	-13
APX4558IS-13	S	SO-8	2500/Tape & Reel	-13



Notes: 10. Pad layout as shown on Diodes Inc. suggested pad layout document AP02001, which can be found on our website at <http://www.diodes.com/datasheets/ap02001.pdf>.

**Marking Information**

**SO-8**

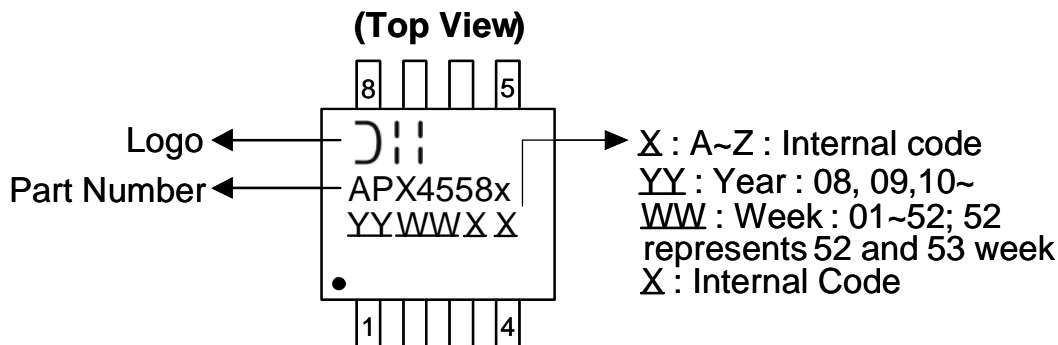

NEW PRODUCT



**Package Outline Dimensions (All Dimensions in mm)**

**SO-8**

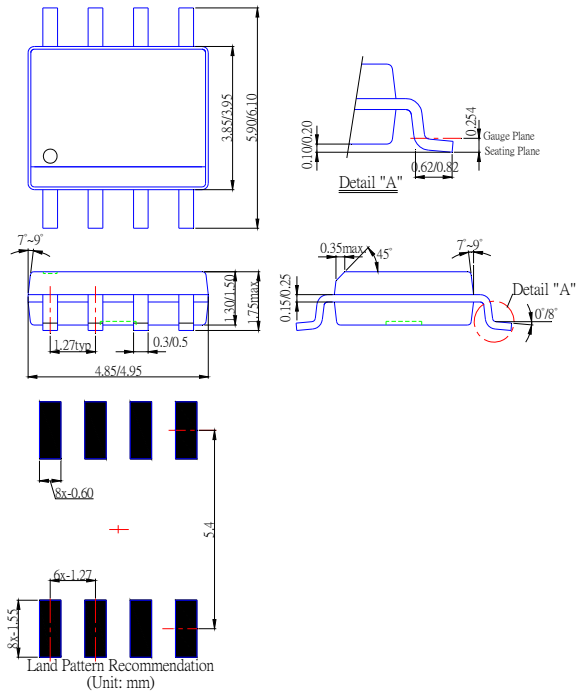

NEW PRODUCT

### IMPORTANT NOTICE

DIODES INCORPORATED MAKES NO WARRANTY OF ANY KIND, EXPRESS OR IMPLIED, WITH REGARDS TO THIS DOCUMENT, INCLUDING, BUT NOT LIMITED TO, THE IMPLIED WARRANTIES OF MERCHANTABILITY AND FITNESS FOR A PARTICULAR PURPOSE (AND THEIR EQUIVALENTS UNDER THE LAWS OF ANY JURISDICTION).

Diodes Incorporated and its subsidiaries reserve the right to make modifications, enhancements, improvements, corrections or other changes without further notice to this document and any product described herein. Diodes Incorporated does not assume any liability arising out of the application or use of this document or any product described herein; neither does Diodes Incorporated convey any license under its patent or trademark rights, nor the rights of others. Any Customer or user of this document or products described herein in such applications shall assume all risks of such use and will agree to hold Diodes Incorporated and all the companies whose products are represented on Diodes Incorporated website, harmless against all damages.

Diodes Incorporated does not warrant or accept any liability whatsoever in respect of any products purchased through unauthorized sales channel.

Should Customers purchase or use Diodes Incorporated products for any unintended or unauthorized application, Customers shall indemnify and hold Diodes Incorporated and its representatives harmless against all claims, damages, expenses, and attorney fees arising out of, directly or indirectly, any claim of personal injury or death associated with such unintended or unauthorized application.

Products described herein may be covered by one or more United States, international or foreign patents pending. Product names and markings noted herein may also be covered by one or more United States, international or foreign trademarks.

### LIFE SUPPORT

Diodes Incorporated products are specifically not authorized for use as critical components in life support devices or systems without the express written approval of the Chief Executive Officer of Diodes Incorporated. As used herein:

A. Life support devices or systems are devices or systems which:

1. are intended to implant into the body, or
2. support or sustain life and whose failure to perform when properly used in accordance with instructions for use provided in the labeling can be reasonably expected to result in significant injury to the user.

B. A critical component is any component in a life support device or system whose failure to perform can be reasonably expected to cause the failure of the life support device or to affect its safety or effectiveness.

Customers represent that they have all necessary expertise in the safety and regulatory ramifications of their life support devices or systems, and acknowledge and agree that they are solely responsible for all legal, regulatory and safety-related requirements concerning their products and any use of Diodes Incorporated products in such safety-critical, life support devices or systems, notwithstanding any devices- or systems-related information or support that may be provided by Diodes Incorporated. Further, Customers must fully indemnify Diodes Incorporated and its representatives against any damages arising out of the use of Diodes Incorporated products in such safety-critical, life support devices or systems.

Copyright © 2011, Diodes Incorporated

[www.diodes.com](http://www.diodes.com)



## Стандарт Электрон Связь

Мы молодая и активно развивающаяся компания в области поставок электронных компонентов. Мы поставляем электронные компоненты отечественного и импортного производства напрямую от производителей и с крупнейших складов мира.

Благодаря сотрудничеству с мировыми поставщиками мы осуществляем комплексные и плановые поставки широчайшего спектра электронных компонентов.

Собственная эффективная логистика и склад в обеспечивает надежную поставку продукции в точно указанные сроки по всей России.

Мы осуществляем техническую поддержку нашим клиентам и предпродажную проверку качества продукции. На все поставляемые продукты мы предоставляем гарантию .

Осуществляем поставки продукции под контролем ВП МО РФ на предприятия военно-промышленного комплекса России , а также работаем в рамках 275 ФЗ с открытием отдельных счетов в уполномоченном банке. Система менеджмента качества компании соответствует требованиям ГОСТ ISO 9001.

Минимальные сроки поставки, гибкие цены, неограниченный ассортимент и индивидуальный подход к клиентам являются основой для выстраивания долгосрочного и эффективного сотрудничества с предприятиями радиоэлектронной промышленности, предприятиями ВПК и научно-исследовательскими институтами России.

С нами вы становитесь еще успешнее!

### Наши контакты:

**Телефон:** +7 812 627 14 35

**Электронная почта:** [sales@st-electron.ru](mailto:sales@st-electron.ru)

**Адрес:** 198099, Санкт-Петербург,  
Промышленная ул, дом № 19, литера Н,  
помещение 100-Н Офис 331