

Rail-to-Rail Input/Output, 10 MHz Op Amps

Features

- Rail-to-Rail Input/Output
- Wide Bandwidth: 10 MHz (typical)
- Low Noise: 8.7 nV/ $\sqrt{\text{Hz}}$, at 10 kHz (typical)
- Low Offset Voltage:
 - Industrial Temperature: $\pm 500 \mu\text{V}$ (maximum)
 - Extended Temperature: $\pm 250 \mu\text{V}$ (maximum)
- Mid-Supply V_{REF} : MCP6021 and MCP6023
- Low Supply Current: 1 mA (typical)
- Total Harmonic Distortion:
 - 0.00053% (typical, $G = 1 \text{ V/V}$)
- Unity Gain Stable
- Power Supply Range: 2.5V to 5.5V
- Temperature Range:
 - Industrial: -40°C to $+85^\circ\text{C}$
 - Extended: -40°C to $+125^\circ\text{C}$

Applications

- Automotive
- Multi-Pole Active Filters
- Audio Processing
- DAC Buffer
- Test Equipment
- Medical Instrumentation

Design Aids

- SPICE Macro Models
- FilterLab[®] Software
- Mindi[™] Circuit Designer & Simulator
- Microchip Advanced Part Selector (MAPS)
- Analog Demonstration and Evaluation Boards
- Application Notes

Typical Application

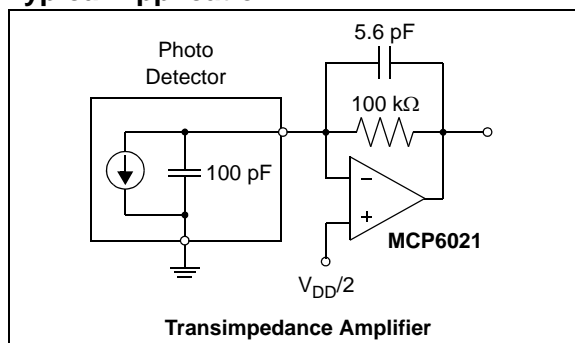

Description

The MCP6021, MCP6021R, MCP6022, MCP6023 and MCP6024 from Microchip Technology Inc. are rail-to-rail input and output op amps with high performance. Key specifications include: wide bandwidth (10 MHz), low noise (8.7 nV/ $\sqrt{\text{Hz}}$), low input offset voltage and low distortion (0.00053% THD+N). The MCP6023 also offers a Chip Select pin (CS) that gives power savings when the part is not in use.

The single MCP6021 and MCP6021R are available in SOT-23-5. The single MCP6021, single MCP6023 and dual MCP6022 are available in 8-lead PDIP, SOIC and TSSOP. The Extended Temperature single MCP6021 is available in 8-lead MSOP. The quad MCP6024 is offered in 14-lead PDIP, SOIC and TSSOP packages.

The MCP6021/1R/2/3/4 family is available in Industrial and Extended temperature ranges. It has a power supply range of 2.5V to 5.5V.

Package Types

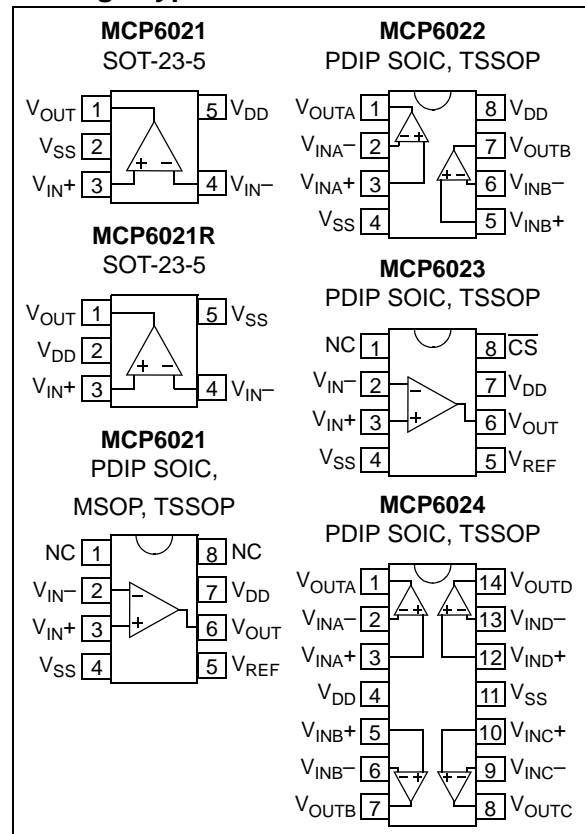

MCP6021/1R/2/3/4

NOTES:

1.0 ELECTRICAL CHARACTERISTICS

Absolute Maximum Ratings †

$V_{DD} - V_{SS}$	7.0V
Current at Analog Input Pins (V_{IN+} , V_{IN-})	± 2 mA
Analog Inputs (V_{IN+} , V_{IN-}) ††	$V_{SS} - 1.0V$ to $V_{DD} + 1.0V$
All Other Inputs and Outputs	$V_{SS} - 0.3V$ to $V_{DD} + 0.3V$
Difference Input Voltage	$ V_{DD} - V_{SS} $
Output Short Circuit Current	Continuous
Current at Output and Supply Pins	± 30 mA
Storage Temperature	-65° C to $+150^{\circ}$ C
Maximum Junction Temperature (T_J)	$+150^{\circ}$ C
ESD Protection On All Pins (HBM; MM)	≥ 2 kV; 200V

† **Notice:** Stresses above those listed under “Absolute Maximum Ratings” may cause permanent damage to the device. This is a stress rating only and functional operation of the device at those or any other conditions above those indicated in the operational listings of this specification is not implied. Exposure to maximum rating conditions for extended periods may affect device reliability.

†† See Section 4.1.2 “ Input Voltage and Current Limits”.

DC ELECTRICAL CHARACTERISTICS

Electrical Specifications: Unless otherwise indicated, $T_A = +25^{\circ}$ C, $V_{DD} = +2.5V$ to $+5.5V$, $V_{SS} = GND$, $V_{CM} = V_{DD}/2$, $V_{OUT} \approx V_{DD}/2$ and $R_L = 10$ k Ω to $V_{DD}/2$.

Parameters	Sym	Min	Typ	Max	Units	Conditions
Input Offset						
Input Offset Voltage:						
Industrial Temperature Parts	V_{OS}	-500	—	+500	μ V	$V_{CM} = 0V$
Extended Temperature Parts	V_{OS}	-250	—	+250	μ V	$V_{CM} = 0V$, $V_{DD} = 5.0V$
Extended Temperature Parts	V_{OS}	-2.5	—	+2.5	mV	$V_{CM} = 0V$, $V_{DD} = 5.0V$ $T_A = -40^{\circ}$ C to $+125^{\circ}$ C
Input Offset Voltage Temperature Drift	$\Delta V_{OS}/\Delta T_A$	—	± 3.5	—	μ V/ $^{\circ}$ C	$T_A = -40^{\circ}$ C to $+125^{\circ}$ C
Power Supply Rejection Ratio	PSRR	74	90	—	dB	$V_{CM} = 0V$
Input Current and Impedance						
Input Bias Current	I_B	—	1	—	pA	
Industrial Temperature Parts	I_B	—	30	150	pA	$T_A = +85^{\circ}$ C
Extended Temperature Parts	I_B	—	640	5,000	pA	$T_A = +125^{\circ}$ C
Input Offset Current	I_{OS}	—	± 1	—	pA	
Common-Mode Input Impedance	Z_{CM}	—	$10^{13} 6$	—	ΩpF	
Differential Input Impedance	Z_{DIFF}	—	$10^{13} 3$	—	ΩpF	
Common-Mode						
Common-Mode Input Range	V_{CMR}	$V_{SS}-0.3$	—	$V_{DD}+0.3$	V	
Common-Mode Rejection Ratio	CMRR	74	90	—	dB	$V_{DD} = 5V$, $V_{CM} = -0.3V$ to $5.3V$
	CMRR	70	85	—	dB	$V_{DD} = 5V$, $V_{CM} = 3.0V$ to $5.3V$
	CMRR	74	90	—	dB	$V_{DD} = 5V$, $V_{CM} = -0.3V$ to $3.0V$
Voltage Reference (MCP6021 and MCP6023 only)						
V_{REF} Accuracy ($V_{REF} - V_{DD}/2$)	V_{REF_ACC}	-50	—	+50	mV	
V_{REF} Temperature Drift	$\Delta V_{REF}/\Delta T_A$	—	± 100	—	μ V/ $^{\circ}$ C	$T_A = -40^{\circ}$ C to $+125^{\circ}$ C
Open-Loop Gain						
DC Open-Loop Gain (Large Signal)	A_{OL}	90	110	—	dB	$V_{CM} = 0V$, $V_{OUT} = V_{SS}+0.3V$ to $V_{DD}-0.3V$
Output						
Maximum Output Voltage Swing	V_{OL} , V_{OH}	$V_{SS}+15$	—	$V_{DD}-20$	mV	0.5V input overdrive
Output Short Circuit Current	I_{SC}	—	± 30	—	mA	$V_{DD} = 2.5V$
	I_{SC}	—	± 22	—	mA	$V_{DD} = 5.5V$

MCP6021/1R/2/3/4

AC ELECTRICAL CHARACTERISTICS

Electrical Specifications: Unless otherwise indicated, $T_A = +25^\circ\text{C}$, $V_{DD} = +2.5\text{V}$ to $+5.5\text{V}$, $V_{SS} = \text{GND}$, $V_{CM} = V_{DD}/2$, $V_{OUT} \approx V_{DD}/2$, $R_L = 10\text{ k}\Omega$ to $V_{DD}/2$ and $C_L = 60\text{ pF}$.						
Parameters	Sym	Min	Typ	Max	Units	Conditions
Power Supply						
Supply Voltage	V_{DD}	2.5	—	5.5	V	
Quiescent Current per Amplifier	I_Q	0.5	1.0	1.35	mA	$I_O = 0$
AC Response						
Gain Bandwidth Product	GBWP	—	10	—	MHz	
Phase Margin	PM	—	65	—	°	$G = +1\text{ V/V}$
Settling Time, 0.2%	t_{SETTLE}	—	250	—	ns	$G = +1\text{ V/V}$, $V_{OUT} = 100\text{ mV}_{P-P}$
Slew Rate	SR	—	7.0	—	V/ μs	
Total Harmonic Distortion Plus Noise						
$f = 1\text{ kHz}$, $G = +1\text{ V/V}$	THD+N	—	0.00053	—	%	$V_{OUT} = 0.25\text{V}$ to 3.25V ($1.75\text{V} \pm 1.50\text{V}_{PK}$), $V_{DD} = 5.0\text{V}$, $BW = 22\text{ kHz}$
$f = 1\text{ kHz}$, $G = +1\text{ V/V}$, $R_L = 600\Omega$	THD+N	—	0.00064	—	%	$V_{OUT} = 0.25\text{V}$ to 3.25V ($1.75\text{V} \pm 1.50\text{V}_{PK}$), $V_{DD} = 5.0\text{V}$, $BW = 22\text{ kHz}$
$f = 1\text{ kHz}$, $G = +1\text{ V/V}$	THD+N	—	0.0014	—	%	$V_{OUT} = 4\text{V}_{P-P}$, $V_{DD} = 5.0\text{V}$, $BW = 22\text{ kHz}$
$f = 1\text{ kHz}$, $G = +10\text{ V/V}$	THD+N	—	0.0009	—	%	$V_{OUT} = 4\text{V}_{P-P}$, $V_{DD} = 5.0\text{V}$, $BW = 22\text{ kHz}$
$f = 1\text{ kHz}$, $G = +100\text{ V/V}$	THD+N	—	0.005	—	%	$V_{OUT} = 4\text{V}_{P-P}$, $V_{DD} = 5.0\text{V}$, $BW = 22\text{ kHz}$
Noise						
Input Noise Voltage	E_{ni}	—	2.9	—	μV_{p-p}	$f = 0.1\text{ Hz}$ to 10 Hz
Input Noise Voltage Density	e_{ni}	—	8.7	—	$\text{nV}/\sqrt{\text{Hz}}$	$f = 10\text{ kHz}$
Input Noise Current Density	i_{ni}	—	3	—	$\text{fA}/\sqrt{\text{Hz}}$	$f = 1\text{ kHz}$

MCP6023 CHIP SELECT ($\overline{\text{CS}}$) ELECTRICAL CHARACTERISTICS

Electrical Specifications: Unless otherwise indicated, $T_A = +25^\circ\text{C}$, $V_{DD} = +2.5\text{V}$ to $+5.5\text{V}$, $V_{SS} = \text{GND}$, $V_{CM} = V_{DD}/2$, $V_{OUT} \approx V_{DD}/2$, $R_L = 10\text{ k}\Omega$ to $V_{DD}/2$ and $C_L = 60\text{ pF}$.						
Parameters	Sym	Min	Typ	Max	Units	Conditions
$\overline{\text{CS}}$ Low Specifications						
$\overline{\text{CS}}$ Logic Threshold, Low	V_{IL}	V_{SS}	—	$0.2 V_{DD}$	V	
$\overline{\text{CS}}$ Input Current, Low	I_{CSL}	-1.0	0.01	—	μA	$\overline{\text{CS}} = V_{SS}$
$\overline{\text{CS}}$ High Specifications						
$\overline{\text{CS}}$ Logic Threshold, High	V_{IH}	$0.8 V_{DD}$	—	V_{DD}	V	
$\overline{\text{CS}}$ Input Current, High	I_{CSH}	—	0.01	2.0	μA	$\overline{\text{CS}} = V_{DD}$
GND Current	I_{SS}	-2	-0.05	—	μA	$\overline{\text{CS}} = V_{DD}$
Amplifier Output Leakage	$I_{O(LEAK)}$	—	0.01	—	μA	$\overline{\text{CS}} = V_{DD}$
$\overline{\text{CS}}$ Dynamic Specifications						
$\overline{\text{CS}}$ Low to Amplifier Output Turn-on Time	t_{ON}	—	2	10	μs	$G = +1$, $V_{IN} = V_{SS}$, $\overline{\text{CS}} = 0.2V_{DD}$ to $V_{OUT} = 0.45V_{DD}$ time
$\overline{\text{CS}}$ High to Amplifier Output High-Z Time	t_{OFF}	—	0.01	—	μs	$G = +1$, $V_{IN} = V_{SS}$, $\overline{\text{CS}} = 0.8V_{DD}$ to $V_{OUT} = 0.05V_{DD}$ time
Hysteresis	V_{HYST}	—	0.6	—	V	$V_{DD} = 5.0\text{V}$, Internal Switch

TEMPERATURE CHARACTERISTICS

Electrical Specifications: Unless otherwise indicated, $V_{DD} = +2.5V$ to $+5.5V$ and $V_{SS} = GND$.						
Parameters	Sym	Min	Typ	Max	Units	Conditions
Temperature Ranges						
Industrial Temperature Range	T_A	-40	—	+85	$^{\circ}C$	
Extended Temperature Range	T_A	-40	—	+125	$^{\circ}C$	
Operating Temperature Range	T_A	-40	—	+125	$^{\circ}C$	Note 1
Storage Temperature Range	T_A	-65	—	+150	$^{\circ}C$	
Thermal Package Resistances						
Thermal Resistance, 5L-SOT-23	θ_{JA}	—	256	—	$^{\circ}C/W$	
Thermal Resistance, 8L-PDIP	θ_{JA}	—	85	—	$^{\circ}C/W$	
Thermal Resistance, 8L-SOIC	θ_{JA}	—	163	—	$^{\circ}C/W$	
Thermal Resistance, 8L-MSOP	θ_{JA}	—	206	—	$^{\circ}C/W$	
Thermal Resistance, 8L-TSSOP	θ_{JA}	—	124	—	$^{\circ}C/W$	
Thermal Resistance, 14L-PDIP	θ_{JA}	—	70	—	$^{\circ}C/W$	
Thermal Resistance, 14L-SOIC	θ_{JA}	—	120	—	$^{\circ}C/W$	
Thermal Resistance, 14L-TSSOP	θ_{JA}	—	100	—	$^{\circ}C/W$	

Note 1: The industrial temperature devices operate over this extended temperature range, but with reduced performance. In any case, the internal junction temperature (T_J) must not exceed the absolute maximum specification of $150^{\circ}C$.



FIGURE 1-1: Timing diagram for the \overline{CS} pin on the MCP6023.

1.1 Test Circuits

The test circuits used for the DC and AC tests are shown in [Figure 1-2](#) and [Figure 1-3](#). The bypass capacitors are laid out according to the rules discussed in [Section 4.7 “Supply Bypass”](#).



FIGURE 1-2: AC and DC Test Circuit for Most Non-Inverting Gain Conditions.



FIGURE 1-3: AC and DC Test Circuit for Most Inverting Gain Conditions.

MCP6021/1R/2/3/4

NOTES:

2.0 TYPICAL PERFORMANCE CURVES

Note: The graphs and tables provided following this note are a statistical summary based on a limited number of samples and are provided for informational purposes only. The performance characteristics listed herein are not tested or guaranteed. In some graphs or tables, the data presented may be outside the specified operating range (e.g., outside specified power supply range) and therefore outside the warranted range.

Note: Unless otherwise indicated, $T_A = +25^\circ\text{C}$, $V_{DD} = +2.5\text{V}$ to $+5.5\text{V}$, $V_{SS} = \text{GND}$, $V_{CM} = V_{DD}/2$, $V_{OUT} \approx V_{DD}/2$, $R_L = 10\text{ k}\Omega$ to $V_{DD}/2$ and $C_L = 60\text{ pF}$.



FIGURE 2-1: Input Offset Voltage, (Industrial Temperature Parts).



FIGURE 2-4: Input Offset Voltage Drift, (Industrial Temperature Parts).



FIGURE 2-2: Input Offset Voltage, (Extended Temperature Parts).



FIGURE 2-5: Input Offset Voltage Drift, (Extended Temperature Parts).



FIGURE 2-3: Input Offset Voltage vs. Common Mode Input Voltage with $V_{DD} = 2.5\text{V}$.



FIGURE 2-6: Input Offset Voltage vs. Common Mode Input Voltage with $V_{DD} = 5.5\text{V}$.

MCP6021/1R/2/3/4

Note: Unless otherwise indicated, $T_A = +25^\circ\text{C}$, $V_{DD} = +2.5\text{V}$ to $+5.5\text{V}$, $V_{SS} = \text{GND}$, $V_{CM} = V_{DD}/2$, $V_{OUT} \approx V_{DD}/2$, $R_L = 10\text{ k}\Omega$ to $V_{DD}/2$ and $C_L = 60\text{ pF}$.



FIGURE 2-7: Input Offset Voltage vs. Temperature.



FIGURE 2-10: Input Offset Voltage vs. Output Voltage.



FIGURE 2-8: Input Noise Voltage Density vs. Frequency.



FIGURE 2-11: Input Noise Voltage Density vs. Common Mode Input Voltage.

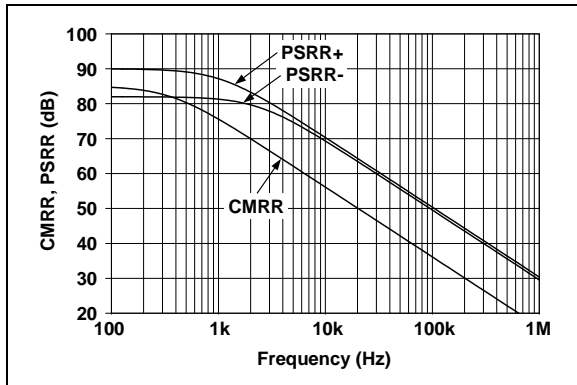

FIGURE 2-9: CMRR, PSRR vs. Frequency.

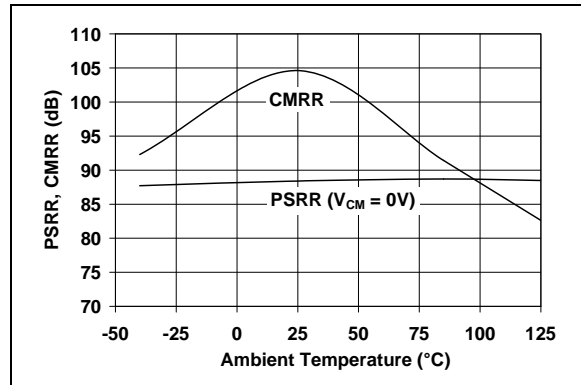

FIGURE 2-12: CMRR, PSRR vs. Temperature.

Note: Unless otherwise indicated, $T_A = +25^\circ\text{C}$, $V_{DD} = +2.5\text{V}$ to $+5.5\text{V}$, $V_{SS} = \text{GND}$, $V_{CM} = V_{DD}/2$, $V_{OUT} \approx V_{DD}/2$, $R_L = 10\text{ k}\Omega$ to $V_{DD}/2$ and $C_L = 60\text{ pF}$.



FIGURE 2-13: Input Bias, Offset Currents vs. Common Mode Input Voltage.



FIGURE 2-16: Input Bias, Offset Currents vs. Temperature.



FIGURE 2-14: Quiescent Current vs. Supply Voltage.



FIGURE 2-17: Quiescent Current vs. Temperature.



FIGURE 2-15: Output Short-Circuit Current vs. Supply Voltage.



FIGURE 2-18: Open-Loop Gain, Phase vs. Frequency.

MCP6021/1R/2/3/4

Note: Unless otherwise indicated, $T_A = +25^\circ\text{C}$, $V_{DD} = +2.5\text{V}$ to $+5.5\text{V}$, $V_{SS} = \text{GND}$, $V_{CM} = V_{DD}/2$, $V_{OUT} \approx V_{DD}/2$, $R_L = 10\text{ k}\Omega$ to $V_{DD}/2$ and $C_L = 60\text{ pF}$.



FIGURE 2-19: DC Open-Loop Gain vs. Load Resistance.

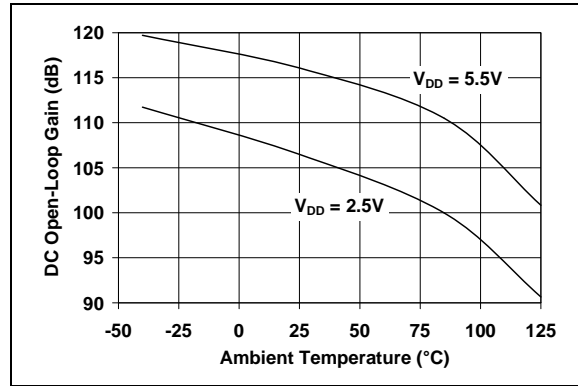

FIGURE 2-22: DC Open-Loop Gain vs. Temperature.



FIGURE 2-20: Small Signal DC Open-Loop Gain vs. Output Voltage Headroom.

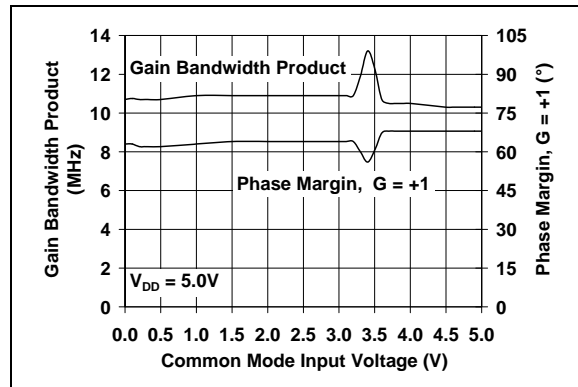

FIGURE 2-23: Gain Bandwidth Product, Phase Margin vs. Common Mode Input Voltage.



FIGURE 2-21: Gain Bandwidth Product, Phase Margin vs. Temperature.

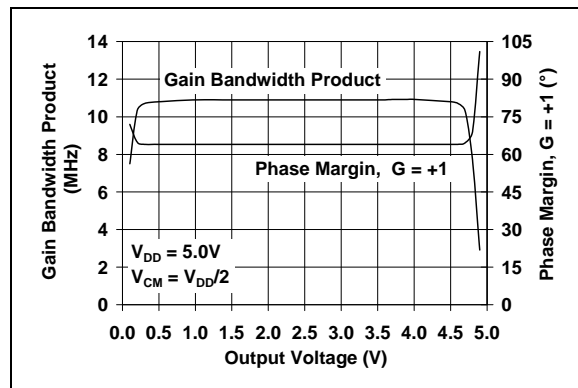

FIGURE 2-24: Gain Bandwidth Product, Phase Margin vs. Output Voltage.

MCP6021/1R/2/3/4

Note: Unless otherwise indicated, $T_A = +25^\circ\text{C}$, $V_{DD} = +2.5\text{V}$ to $+5.5\text{V}$, $V_{SS} = \text{GND}$, $V_{CM} = V_{DD}/2$, $V_{OUT} \approx V_{DD}/2$, $R_L = 10\text{ k}\Omega$ to $V_{DD}/2$ and $C_L = 60\text{ pF}$.



FIGURE 2-25: Slew Rate vs. Temperature.



FIGURE 2-28: Maximum Output Voltage Swing vs. Frequency.



FIGURE 2-26: Total Harmonic Distortion plus Noise vs. Output Voltage with $f = 1\text{ kHz}$.



FIGURE 2-29: Total Harmonic Distortion plus Noise vs. Output Voltage with $f = 20\text{ kHz}$.



FIGURE 2-27: The MCP6021/1R/2/3/4 family shows no phase reversal under overdrive.



FIGURE 2-30: Channel-to-Channel Separation vs. Frequency (MCP6022 and MCP6024 only).

MCP6021/1R/2/3/4

Note: Unless otherwise indicated, $T_A = +25^\circ\text{C}$, $V_{DD} = +2.5\text{V to } +5.5\text{V}$, $V_{SS} = \text{GND}$, $V_{CM} = V_{DD}/2$, $V_{OUT} \approx V_{DD}/2$, $R_L = 10\text{ k}\Omega$ to $V_{DD}/2$ and $C_L = 60\text{ pF}$.



FIGURE 2-31: Output Voltage Headroom vs. Output Current.



FIGURE 2-34: Output Voltage Headroom vs. Temperature.



FIGURE 2-32: Small-Signal Non-inverting Pulse Response.



FIGURE 2-35: Small-Signal Inverting Pulse Response.

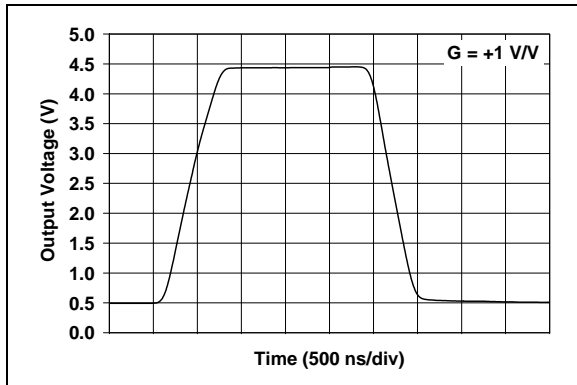

FIGURE 2-33: Large-Signal Non-inverting Pulse Response.

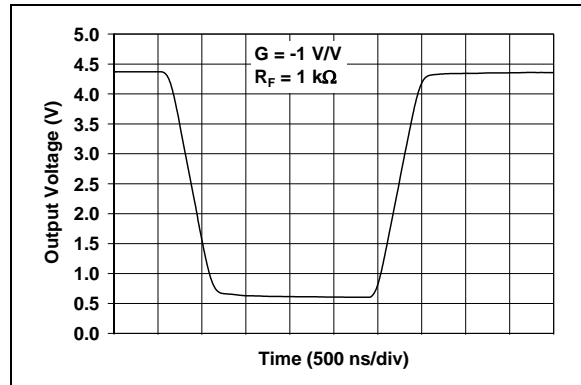

FIGURE 2-36: Large-Signal Inverting Pulse Response.

Note: Unless otherwise indicated, $T_A = +25^\circ\text{C}$, $V_{DD} = +2.5\text{V}$ to $+5.5\text{V}$, $V_{SS} = \text{GND}$, $V_{CM} = V_{DD}/2$, $V_{OUT} \approx V_{DD}/2$, $R_L = 10\text{ k}\Omega$ to $V_{DD}/2$ and $C_L = 60\text{ pF}$.



FIGURE 2-37: V_{REF} Accuracy vs. Supply Voltage (MCP6021 and MCP6023 only).



FIGURE 2-40: V_{REF} Accuracy vs. Temperature (MCP6021 and MCP6023 only).



FIGURE 2-38: Chip Select ($\overline{\text{CS}}$) Hysteresis (MCP6023 only) with $V_{DD} = 2.5\text{V}$.



FIGURE 2-41: Chip Select ($\overline{\text{CS}}$) Hysteresis (MCP6023 only) with $V_{DD} = 5.5\text{V}$.



FIGURE 2-39: Chip Select ($\overline{\text{CS}}$) to Amplifier Output Response Time (MCP6023 only).



FIGURE 2-42: Measured Input Current vs. Input Voltage (below V_{SS}).

MCP6021/1R/2/3/4

NOTES:

3.0 PIN DESCRIPTIONS

Descriptions of the pins are listed in [Table 3-1](#).

TABLE 3-1: PIN FUNCTION TABLE

MCP6021		MCP6021R	MCP6022	MCP6023	MCP6024	Symbol	Description
PDIP, SOIC, MSOP, TSSOP (Note 1)	SOT-23-5	SOT-23-5 (Note 2)	PDIP, SOIC, TSSOP	PDIP, SOIC, TSSOP	PDIP, SOIC, TSSOP		
6	1	1	1	6	1	V_{OUT}, V_{OUTA}	Analog Output (op amp A)
2	4	4	2	2	2	V_{IN-}, V_{INA-}	Inverting Input (op amp A)
3	3	3	3	3	3	V_{IN+}, V_{INA+}	Non-inverting Input (op amp A)
7	5	2	8	7	4	V_{DD}	Positive Power Supply
—	—	—	5	—	5	V_{INB+}	Non-inverting Input (op amp B)
—	—	—	6	—	6	V_{INB-}	Inverting Input (op amp B)
—	—	—	7	—	7	V_{OUTB}	Analog Output (op amp B)
—	—	—	—	—	8	V_{OUTC}	Analog Output (op amp C)
—	—	—	—	—	9	V_{INC-}	Inverting Input (op amp C)
—	—	—	—	—	10	V_{INC+}	Non-inverting Input (op amp C)
4	2	5	4	4	11	V_{SS}	Negative Power Supply
—	—	—	—	—	12	V_{IND+}	Non-inverting Input (op amp D)
—	—	—	—	—	13	V_{IND-}	Inverting Input (op amp D)
—	—	—	—	—	14	V_{OUTD}	Analog Output (op amp D)
5	—	—	—	5	—	V_{REF}	Reference Voltage
—	—	—	—	8	—	\overline{CS}	Chip Select
1, 8	—	—	—	1	—	NC	No Internal Connection

Note 1: The MCP6021 in the 8-pin TSSOP package is only available for I-temp (Industrial Temperature) parts.

Note 2: The MCP6021R is only available in the 5-pin SOT-23 package, and for E-temp (Extended Temperature) parts.

3.1 Analog Outputs

The op amp output pins are low-impedance voltage sources.

3.2 Analog Inputs

The op amp non-inverting and inverting inputs are high-impedance CMOS inputs with low bias currents.

3.3 Reference Voltage (V_{REF}) MCP6021 and MCP6023

Mid-supply reference voltage provided by the single op amps (except in SOT-23-5 package). This is an unbuffered, resistor voltage divider internal to the part.

3.4 Chip Select Digital Input (\overline{CS})

This is a CMOS, Schmitt-triggered input that places the part into a low power mode of operation.

3.5 Power Supply (V_{SS} and V_{DD})

The positive power supply pin (V_{DD}) is 2.5V to 6.0V higher than the negative power supply pin (V_{SS}). For normal operation, the other pins are at voltages between V_{SS} and V_{DD} .

Typically, these parts are used in a single (positive) supply configuration. In this case, V_{SS} is connected to ground and V_{DD} is connected to the supply. V_{DD} will need a bypass capacitor.

MCP6021/1R/2/3/4

NOTES:

4.0 APPLICATIONS INFORMATION

The MCP6021/1R/2/3/4 family of operational amplifiers are fabricated on Microchip's state-of-the-art CMOS process. They are unity-gain stable and suitable for a wide range of general-purpose applications.

4.1 Rail-to-Rail Input

4.1.1 PHASE REVERSAL

The MCP6021/1R/2/3/4 op amp is designed to prevent phase reversal when the input pins exceed the supply voltages. Figure 2-42 shows the input voltage exceeding the supply voltage without any phase reversal.

4.1.2 INPUT VOLTAGE AND CURRENT LIMITS

The ESD protection on the inputs can be depicted as shown in Figure 4-1. This structure was chosen to protect the input transistors, and to minimize input bias current (I_B). The input ESD diodes clamp the inputs when they try to go more than one diode drop below V_{SS} . They also clamp any voltages that go too far above V_{DD} ; their breakdown voltage is high enough to allow normal operation, and low enough to bypass quick ESD events within the specified limits.



FIGURE 4-1: Simplified Analog Input ESD Structures.

In order to prevent damage and/or improper operation of these op amps, the circuit they are in must limit the currents and voltages at the V_{IN+} and V_{IN-} pins (see **Absolute Maximum Ratings** † at the beginning of **Section 1.0 “Electrical Characteristics”**). Figure 4-2 shows the recommended approach to protecting these inputs. The internal ESD diodes prevent the input pins (V_{IN+} and V_{IN-}) from going too far below ground, and the resistors R_1 and R_2 limit the possible current drawn out of the input pins. Diodes D_1 and D_2 prevent the input pins (V_{IN+} and V_{IN-}) from going too far above V_{DD} , and dump any currents onto V_{DD} . When implemented as shown, resistors R_1 and R_2 also limit the current through D_1 and D_2 .



FIGURE 4-2: Protecting the Analog Inputs.

It is also possible to connect the diodes to the left of resistors R_1 and R_2 . In this case, current through the diodes D_1 and D_2 needs to be limited by some other mechanism. The resistors then serve as in-rush current limiters; the DC current into the input pins (V_{IN+} and V_{IN-}) should be very small.

A significant amount of current can flow out of the inputs when the common mode voltage (V_{CM}) is below ground (V_{SS}); see Figure 2-42. Applications that are high impedance may need to limit the useable voltage range.

4.1.3 NORMAL OPERATION

The input stage of the MCP6021/1R/2/3/4 op amps use two differential CMOS input stages in parallel. One operates at low common mode input voltage (V_{CM}), while the other operates at high V_{CM} . With this topology, the device operates with V_{cm} up to 0.3V above V_{DD} and 0.3V below V_{SS} .

4.2 Rail-to-Rail Output

The Maximum Output Voltage Swing is the maximum swing possible under a particular output load. According to the specification table, the output can reach within 20 mV of either supply rail when $R_L = 10 \text{ k}\Omega$. See Figure 2-31 and Figure 2-34 for more information concerning typical performance.

4.3 Capacitive Loads

Driving large capacitive loads can cause stability problems for voltage feedback op amps. As the load capacitance increases, the feedback loop's phase margin decreases, and the closed loop bandwidth is reduced. This produces gain-peaking in the frequency response, with overshoot and ringing in the step response.

MCP6021/1R/2/3/4

When driving large capacitive loads with these op amps (e.g., > 60 pF when $G = +1$), a small series resistor at the output (R_{ISO} in Figure 4-3) improves the feedback loop's phase margin (stability) by making the load resistive at higher frequencies. The bandwidth will be generally lower than the bandwidth with no capacitive load.



FIGURE 4-3: Output Resistor R_{ISO} Stabilizes Large Capacitive Loads.

Figure 4-4 gives recommended R_{ISO} values for different capacitive loads and gains. The x-axis is the normalized load capacitance (C_L/G_N), where G_N is the circuit's noise gain. For non-inverting gains, G_N and the Signal Gain are equal. For inverting gains, G_N is $1+|\text{Signal Gain}|$ (e.g., -1 V/V gives $G_N = +2$ V/V).



FIGURE 4-4: Recommended R_{ISO} values for capacitive loads.

After selecting R_{ISO} for your circuit, double-check the resulting frequency response peaking and step response overshoot. Modify R_{ISO} 's value until the response is reasonable. Evaluation on the bench and simulations with the MCP6021/1R/2/3/4 Spice macro model are helpful.

4.4 Gain Peaking

Figure 2-35 and Figure 2-36 use $R_F = 1$ k Ω to avoid (frequency response) gain peaking and (step response) overshoot. The capacitance to ground at the inverting input (C_G) is the op amp's common mode input capacitance plus board parasitic capacitance. C_G is in parallel with R_G , which causes an increase in gain at high frequencies for non-inverting gains greater than

1 V/V (unity gain). C_G also reduces the phase margin of the feedback loop for both non-inverting and inverting gains.



FIGURE 4-5: Non-inverting Gain Circuit with Parasitic Capacitance.

The largest value of R_F in Figure 4-5 that should be used is a function of noise gain (see G_N in Section 4.3 "Capacitive Loads") and C_G . Figure 4-6 shows results for various conditions. Other compensation techniques may be used, but they tend to be more complicated to the design.



FIGURE 4-6: Non-inverting gain circuit with parasitic capacitance.

4.5 MCP6023 Chip Select (\overline{CS})

The MCP6023 is a single amplifier with chip select (\overline{CS}). When \overline{CS} is pulled high, the supply current drops to 10 nA (typical) and flows through the \overline{CS} pin to V_{SS} . When this happens, the amplifier output is put into a high-impedance state. By pulling \overline{CS} low, the amplifier is enabled. The \overline{CS} pin has an internal 5 M Ω (typical) pulldown resistor connected to V_{SS} , so it will go low if the \overline{CS} pin is left floating. Figure 1-1 and Figure 2-39 show the output voltage and supply current response to a \overline{CS} pulse.

4.6 MCP6021 and MCP6023 Reference Voltage

The single op amps (MCP6021 and MCP6023), not in the SOT-23-5 package, have an internal mid-supply reference voltage connected to the V_{REF} pin (see Figure 4-7). The MCP6021 has \overline{CS} internally tied to V_{SS} , which always keeps the op amp on and always provides a mid-supply reference. With the MCP6023, taking the \overline{CS} pin high conserves power by shutting down both the op amp and the V_{REF} circuitry. Taking the \overline{CS} pin low turns on the op amp and V_{REF} circuitry.



FIGURE 4-7: Simplified internal V_{REF} circuit (MCP6021 and MCP6023 only).

See Figure 4-8 for a non-inverting gain circuit using the internal mid-supply reference. The DC-blocking capacitor (C_B) also reduces noise by coupling the op amp input to the source.



FIGURE 4-8: Non-inverting gain circuit using V_{REF} (MCP6021 and MCP6023 only).

To use the internal mid-supply reference for an inverting gain circuit, connect the V_{REF} pin to the non-inverting input, as shown in Figure 4-9. The capacitor C_B helps reduce power supply noise on the output.



FIGURE 4-9: Inverting gain circuit using V_{REF} (MCP6021 and MCP6023 only).

If you don't need the mid-supply reference, leave the V_{REF} pin open.

4.7 Supply Bypass

With this family of operational amplifiers, the power supply pin (V_{DD} for single supply) should have a local bypass capacitor (i.e., 0.01 μF to 0.1 μF) within 2 mm for good, high-frequency performance. It also needs a bulk capacitor (i.e., 1 μF or larger) within 100 mm to provide large, slow currents. This bulk capacitor can be shared with nearby analog parts.

4.8 Unused Op Amps

An unused op amp in a quad package (MCP6024) should be configured as shown in Figure 4-10. These circuits prevent the output from toggling and causing crosstalk. Circuit A sets the op amp at its minimum noise gain. The resistor divider produces any desired reference voltage within the output voltage range of the op amp; the op amp buffers that reference voltage. Circuit B uses the minimum number of components and operates as a comparator, but it may draw more current.



FIGURE 4-10: Unused Op Amps.

MCP6021/1R/2/3/4

4.9 PCB Surface Leakage

In applications where low input bias current is critical, PCB (printed circuit board) surface-leakage effects need to be considered. Surface leakage is caused by humidity, dust or other contamination on the board. Under low humidity conditions, a typical resistance between nearby traces is $10^{12}\Omega$. A 5V difference would cause 5 pA of current to flow, which is greater than the MCP6021/1R/2/3/4 family's bias current at +25°C (1 pA, typical).

The easiest way to reduce surface leakage is to use a guard ring around sensitive pins (or traces). The guard ring is biased at the same voltage as the sensitive pin. [Figure 4-11](#) shows an example of this type of layout.

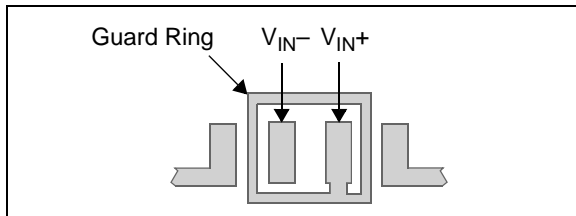

FIGURE 4-11: Example Guard Ring Layout.

1. Non-inverting Gain and Unity-Gain Buffer.
 - a) Connect the guard ring to the inverting input pin (V_{IN-}); this biases the guard ring to the common mode input voltage.
 - b) Connect the non-inverting pin (V_{IN+}) to the input with a wire that does not touch the PCB surface.
2. Inverting ([Figure 4-11](#)) and Transimpedance Gain Amplifiers (convert current to voltage, such as photo detectors).
 - a) Connect the guard ring to the non-inverting input pin (V_{IN+}). This biases the guard ring to the same reference voltage as the op amp's input (e.g., $V_{DD}/2$ or ground).
 - b) Connect the inverting pin (V_{IN-}) to the input with a wire that does not touch the PCB surface.

4.10 High Speed PCB Layout

Due to their speed capabilities, a little extra care in the PCB (Printed Circuit Board) layout can make a significant difference in the performance of these op amps. Good PC board layout techniques will help you achieve the performance shown in [Section 1.0 "Electrical Characteristics"](#) and [Section 2.0 "Typical Performance Curves"](#), while also helping you minimize EMC (Electro-Magnetic Compatibility) issues.

Use a solid ground plane and connect the bypass local capacitor(s) to this plane with minimal length traces. This cuts down inductive and capacitive crosstalk.

Separate digital from analog, low speed from high speed and low power from high power. This will reduce interference.

Keep sensitive traces short and straight. Separating them from interfering components and traces. This is especially important for high-frequency (low rise-time) signals.

Sometimes it helps to place guard traces next to victim traces. They should be on both sides of the victim trace, and as close as possible. Connect the guard trace to ground plane at both ends, and in the middle for long traces.

Use coax cables (or low inductance wiring) to route signal and power to and from the PCB.

4.11 Typical Applications

4.11.1 A/D CONVERTER DRIVER AND ANTI-ALIASING FILTER

[Figure 4-12](#) shows a third-order Butterworth filter that can be used as an A/D converter driver. It has a bandwidth of 20 kHz and a reasonable step response. It will work well for conversion rates of 80 ksp/s and greater (it has 29 dB attenuation at 60 kHz).



FIGURE 4-12: A/D Converter Driver and Anti-aliasing Filter with a 20 kHz Cutoff Frequency.

This filter can easily be adjusted to another bandwidth by multiplying all capacitors by the same factor. Alternatively, the resistors can all be scaled by another common factor to adjust the bandwidth.

4.11.2 OPTICAL DETECTOR AMPLIFIER

Figure 4-13 shows the MCP6021 op amp used as a transimpedance amplifier in a photo detector circuit. The photo detector looks like a capacitive current source, so the 100 k Ω resistor gains the input signal to a reasonable level. The 5.6 pF capacitor stabilizes this circuit and produces a flat frequency response with a bandwidth of 370 kHz.



FIGURE 4-13: *Transimpedance Amplifier for an Optical Detector.*

MCP6021/1R/2/3/4

NOTES:

5.0 DESIGN AIDS

Microchip provides the basic design tools needed for the MCP6021/1R/2/3/4 family of op amps.

5.1 SPICE Macro Model

The latest SPICE macro model available for the MCP6021/1R/2/3/4 op amps is on Microchip's web site at www.microchip.com. This model is intended as an initial design tool that works well in the op amp's linear region of operation at room temperature. Within the macro model file is information on its capabilities.

Bench testing is a very important part of any design and cannot be replaced with simulations. Also, simulation results using this macro model need to be validated by comparing them to the data sheet specifications and characteristic curves.

5.2 FilterLab® Software

Microchip's FilterLab® software is an innovative software tool that simplifies analog active filter (using op amps) design. Available at no cost from the Microchip web site at www.microchip.com/filterlab, the FilterLab design tool provides full schematic diagrams of the filter circuit with component values. It also outputs the filter circuit in SPICE format, which can be used with the macro model to simulate actual filter performance.

5.3 Mindi™ Circuit Designer & Simulator

Microchip's Mindi™ Circuit Designer & Simulator aids in the design of various circuits useful for active filter, amplifier and power-management applications. It is a free online circuit designer & simulator available from the Microchip web site at www.microchip.com/mindi. This interactive circuit designer & simulator enables designers to quickly generate circuit diagrams, simulate circuits. Circuits developed using the Mindi Circuit Designer & Simulator can be downloaded to a personal computer or workstation.

5.4 Microchip Advanced Part Selector (MAPS)

MAPS is a software tool that helps semiconductor professionals efficiently identify Microchip devices that fit a particular design requirement. Available at no cost from the Microchip web site at www.microchip.com/maps, the MAPS is an overall selection tool for Microchip's product portfolio that includes Analog, Memory, MCUs and DSCs. Using this tool you can define a filter to sort features for a parametric search of devices and export side-by-side technical comparison reports. Helpful links are also provided for Data sheets, Purchase, and Sampling of Microchip parts.

5.5 Analog Demonstration and Evaluation Boards

Microchip offers a broad spectrum of Analog Demonstration and Evaluation Boards that are designed to help you achieve faster time to market. For a complete listing of these boards and their corresponding user's guides and technical information, visit the Microchip web site at www.microchip.com/analogtools.

Some boards that are especially useful are:

- MCP6XXX Amplifier Evaluation Board 1
- MCP6XXX Amplifier Evaluation Board 2
- MCP6XXX Amplifier Evaluation Board 3
- MCP6XXX Amplifier Evaluation Board 4
- Active Filter Demo Board Kit
- 8-Pin SOIC/MSOP/TSSOP/DIP Evaluation Board, P/N: SOIC8EV
- 14-Pin SOIC/TSSOP/DIP Evaluation Board, P/N: SOIC14EV

5.6 Application Notes

The following Microchip Application Notes are available on the Microchip web site at www.microchip.com/appnotes and are recommended as supplemental reference resources.

- **ADN003:** "Select the Right Operational Amplifier for your Filtering Circuits", DS21821
- **AN722:** "Operational Amplifier Topologies and DC Specifications", DS00722
- **AN723:** "Operational Amplifier AC Specifications and Applications", DS00723
- **AN884:** "Driving Capacitive Loads With Op Amps", DS00884
- **AN990:** "Analog Sensor Conditioning Circuits – An Overview", DS00990
- **AN1177:** "Op Amp Precision Design: DC Errors", DS01177
- **AN1228:** "Op Amp Precision Design: Random Noise", DS01228

These application notes and others are listed in the design guide:

"Signal Chain Design Guide", DS21825

MCP6021/1R/2/3/4

NOTES:

6.0 PACKAGING INFORMATION

6.1 Package Marking Information

5-Lead SOT-23 (MCP6021/MCP6021R)

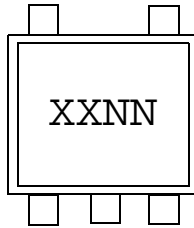

Device	E-Temp Code
MCP6021	EYNN
MCP6021R	EZNN

Note: Applies to 5-Lead SOT-23

Example: (E-temp)

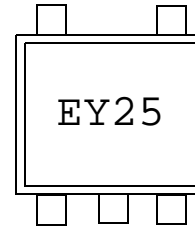

8-Lead PDIP (300 mil)

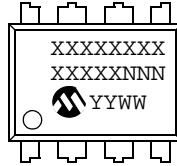

Example:

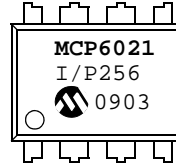

OR

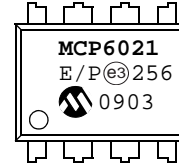

8-Lead SOIC (150 mil)

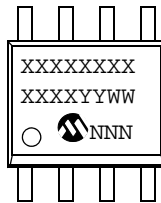

Example:

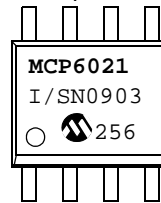

OR

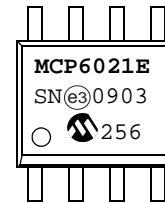

8-Lead MSOP

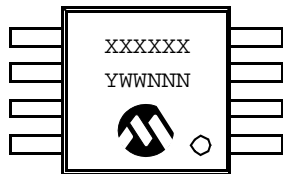

Example:

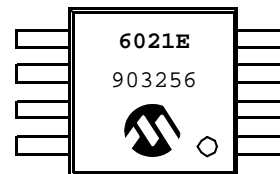

8-Lead TSSOP



Example:



Legend:	XX...X	Customer-specific information
	Y	Year code (last digit of calendar year)
	YY	Year code (last 2 digits of calendar year)
	WW	Week code (week of January 1 is week '01')
	NNN	Alphanumeric traceability code
	(e3)	Pb-free JEDEC designator for Matte Tin (Sn)
	*	This package is Pb-free. The Pb-free JEDEC designator (e3) can be found on the outer packaging for this package.

Note: In the event the full Microchip part number cannot be marked on one line, it will be carried over to the next line, thus limiting the number of available characters for customer-specific information.

MCP6021/1R/2/3/4

Package Marking Information (Continued)

14-Lead PDIP (300 mil) (MCP6024)



Example:



OR



14-Lead SOIC (150 mil) (MCP6024)



Example:



OR



14-Lead TSSOP (MCP6024)



Example:



5-Lead Plastic Small Outline Transistor (OT) [SOT-23]

Note: For the most current package drawings, please see the Microchip Packaging Specification located at <http://www.microchip.com/packaging>



Dimension Limits	Units	MILLIMETERS		
		MIN	NOM	MAX
Number of Pins	N	5		
Lead Pitch	e	0.95 BSC		
Outside Lead Pitch	e1	1.90 BSC		
Overall Height	A	0.90	–	1.45
Molded Package Thickness	A2	0.89	–	1.30
Standoff	A1	0.00	–	0.15
Overall Width	E	2.20	–	3.20
Molded Package Width	E1	1.30	–	1.80
Overall Length	D	2.70	–	3.10
Foot Length	L	0.10	–	0.60
Footprint	L1	0.35	–	0.80
Foot Angle	ϕ	0°	–	30°
Lead Thickness	c	0.08	–	0.26
Lead Width	b	0.20	–	0.51

Notes:

- Dimensions D and E1 do not include mold flash or protrusions. Mold flash or protrusions shall not exceed 0.127 mm per side.
- Dimensioning and tolerancing per ASME Y14.5M.

BSC: Basic Dimension. Theoretically exact value shown without tolerances.

Microchip Technology Drawing C04-091B

MCP6021/1R/2/3/4

8-Lead Plastic Dual In-Line (P) – 300 mil Body [PDIP]

Note: For the most current package drawings, please see the Microchip Packaging Specification located at <http://www.microchip.com/packaging>



Dimension Limits	Units	INCHES		
		MIN	NOM	MAX
Number of Pins	N	8		
Pitch	e	.100 BSC		
Top to Seating Plane	A	–	–	.210
Molded Package Thickness	A2	.115	.130	.195
Base to Seating Plane	A1	.015	–	–
Shoulder to Shoulder Width	E	.290	.310	.325
Molded Package Width	E1	.240	.250	.280
Overall Length	D	.348	.365	.400
Tip to Seating Plane	L	.115	.130	.150
Lead Thickness	c	.008	.010	.015
Upper Lead Width	b1	.040	.060	.070
Lower Lead Width	b	.014	.018	.022
Overall Row Spacing §	eB	–	–	.430

Notes:

- Pin 1 visual index feature may vary, but must be located with the hatched area.
- § Significant Characteristic.
- Dimensions D and E1 do not include mold flash or protrusions. Mold flash or protrusions shall not exceed .010" per side.
- Dimensioning and tolerancing per ASME Y14.5M.

BSC: Basic Dimension. Theoretically exact value shown without tolerances.

Microchip Technology Drawing C04-018B

8-Lead Plastic Small Outline (SN) – Narrow, 3.90 mm Body [SOIC]

Note: For the most current package drawings, please see the Microchip Packaging Specification located at <http://www.microchip.com/packaging>



Dimension Limits	Units	MILLIMETERS		
		MIN	NOM	MAX
Number of Pins	N	8		
Pitch	e	1.27 BSC		
Overall Height	A	–	–	1.75
Molded Package Thickness	A2	1.25	–	–
Standoff §	A1	0.10	–	0.25
Overall Width	E	6.00 BSC		
Molded Package Width	E1	3.90 BSC		
Overall Length	D	4.90 BSC		
Chamfer (optional)	h	0.25	–	0.50
Foot Length	L	0.40	–	1.27
Footprint	L1	1.04 REF		
Foot Angle	ϕ	0°	–	8°
Lead Thickness	c	0.17	–	0.25
Lead Width	b	0.31	–	0.51
Mold Draft Angle Top	α	5°	–	15°
Mold Draft Angle Bottom	β	5°	–	15°

Notes:

- Pin 1 visual index feature may vary, but must be located within the hatched area.
- § Significant Characteristic.
- Dimensions D and E1 do not include mold flash or protrusions. Mold flash or protrusions shall not exceed 0.15 mm per side.
- Dimensioning and tolerancing per ASME Y14.5M.

BSC: Basic Dimension. Theoretically exact value shown without tolerances.

REF: Reference Dimension, usually without tolerance, for information purposes only.

Microchip Technology Drawing C04-057B

MCP6021/1R/2/3/4

8-Lead Plastic Small Outline (SN) – Narrow, 3.90 mm Body [SOIC]

Note: For the most current package drawings, please see the Microchip Packaging Specification located at <http://www.microchip.com/packaging>



RECOMMENDED LAND PATTERN

Dimension Limits	Units	MILLIMETERS		
		MIN	NOM	MAX
Contact Pitch	E	1.27 BSC		
Contact Pad Spacing	C		5.40	
Contact Pad Width (X8)	X1			0.60
Contact Pad Length (X8)	Y1			1.55

Notes:

1. Dimensioning and tolerancing per ASME Y14.5M

BSC: Basic Dimension. Theoretically exact value shown without tolerances.

Microchip Technology Drawing No. C04-2057A

8-Lead Plastic Micro Small Outline Package (MS) [MSOP]

Note: For the most current package drawings, please see the Microchip Packaging Specification located at <http://www.microchip.com/packaging>



Dimension Limits	Units	MILLIMETERS		
		MIN	NOM	MAX
Number of Pins	N	8		
Pitch	e	0.65 BSC		
Overall Height	A	–	–	1.10
Molded Package Thickness	A2	0.75	0.85	0.95
Standoff	A1	0.00	–	0.15
Overall Width	E	4.90 BSC		
Molded Package Width	E1	3.00 BSC		
Overall Length	D	3.00 BSC		
Foot Length	L	0.40	0.60	0.80
Footprint	L1	0.95 REF		
Foot Angle	ϕ	0°	–	8°
Lead Thickness	c	0.08	–	0.23
Lead Width	b	0.22	–	0.40

Notes:

- Pin 1 visual index feature may vary, but must be located within the hatched area.
- Dimensions D and E1 do not include mold flash or protrusions. Mold flash or protrusions shall not exceed 0.15 mm per side.
- Dimensioning and tolerancing per ASME Y14.5M.

BSC: Basic Dimension. Theoretically exact value shown without tolerances.

REF: Reference Dimension, usually without tolerance, for information purposes only.

Microchip Technology Drawing C04-111B

MCP6021/1R/2/3/4

14-Lead Plastic Dual In-Line (P) – 300 mil Body [PDIP]

Note: For the most current package drawings, please see the Microchip Packaging Specification located at <http://www.microchip.com/packaging>

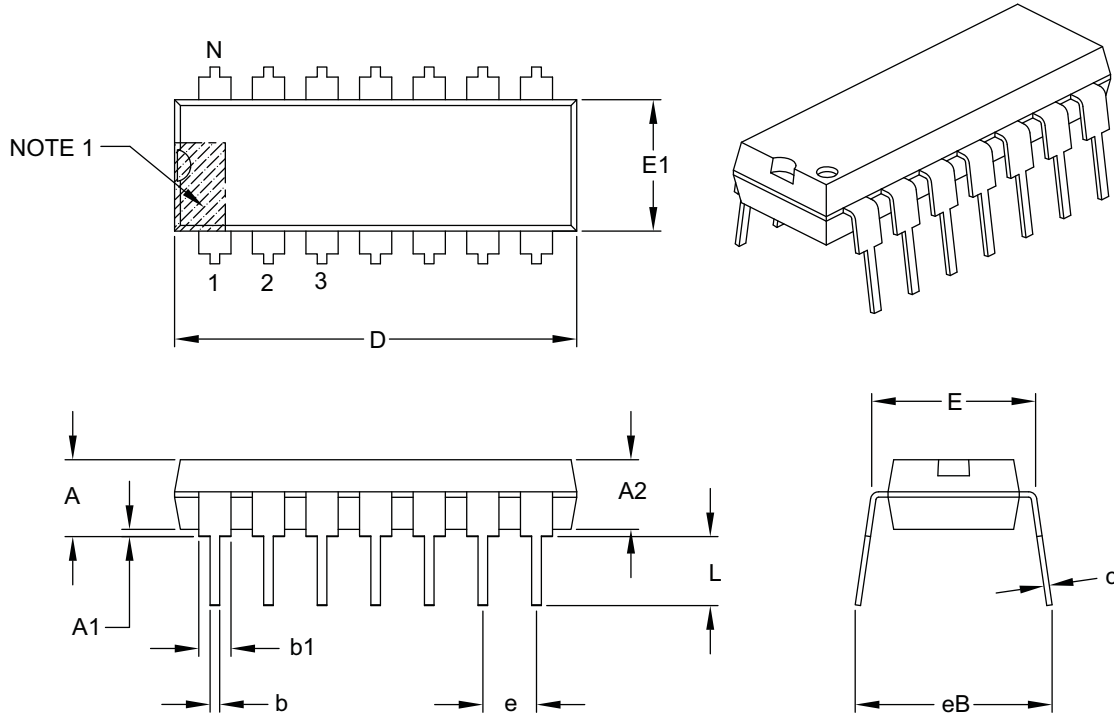

Dimension Limits	Units	INCHES		
		MIN	NOM	MAX
Number of Pins	N	14		
Pitch	e	.100 BSC		
Top to Seating Plane	A	–	–	.210
Molded Package Thickness	A2	.115	.130	.195
Base to Seating Plane	A1	.015	–	–
Shoulder to Shoulder Width	E	.290	.310	.325
Molded Package Width	E1	.240	.250	.280
Overall Length	D	.735	.750	.775
Tip to Seating Plane	L	.115	.130	.150
Lead Thickness	c	.008	.010	.015
Upper Lead Width	b1	.045	.060	.070
Lower Lead Width	b	.014	.018	.022
Overall Row Spacing §	eB	–	–	.430

Notes:

- Pin 1 visual index feature may vary, but must be located with the hatched area.
- § Significant Characteristic.
- Dimensions D and E1 do not include mold flash or protrusions. Mold flash or protrusions shall not exceed .010" per side.
- Dimensioning and tolerancing per ASME Y14.5M.

BSC: Basic Dimension. Theoretically exact value shown without tolerances.

Microchip Technology Drawing C04-005B

14-Lead Plastic Small Outline (SL) – Narrow, 3.90 mm Body [SOIC]

Note: For the most current package drawings, please see the Microchip Packaging Specification located at <http://www.microchip.com/packaging>



Dimension Limits	Units	MILLIMETERS		
		MIN	NOM	MAX
Number of Pins	N	14		
Pitch	e	1.27 BSC		
Overall Height	A	–	–	1.75
Molded Package Thickness	A2	1.25	–	–
Standoff §	A1	0.10	–	0.25
Overall Width	E	6.00 BSC		
Molded Package Width	E1	3.90 BSC		
Overall Length	D	8.65 BSC		
Chamfer (optional)	h	0.25	–	0.50
Foot Length	L	0.40	–	1.27
Footprint	L1	1.04 REF		
Foot Angle	φ	0°	–	8°
Lead Thickness	c	0.17	–	0.25
Lead Width	b	0.31	–	0.51
Mold Draft Angle Top	α	5°	–	15°
Mold Draft Angle Bottom	β	5°	–	15°

Notes:

- Pin 1 visual index feature may vary, but must be located within the hatched area.
- § Significant Characteristic.
- Dimensions D and E1 do not include mold flash or protrusions. Mold flash or protrusions shall not exceed 0.15 mm per side.
- Dimensioning and tolerancing per ASME Y14.5M.

BSC: Basic Dimension. Theoretically exact value shown without tolerances.

REF: Reference Dimension, usually without tolerance, for information purposes only.

Microchip Technology Drawing C04-065B

MCP6021/1R/2/3/4

14-Lead Plastic Small Outline (SL) - Narrow, 3.90 mm Body [SOIC]

Note: For the most current package drawings, please see the Microchip Packaging Specification located at <http://www.microchip.com/packaging>



RECOMMENDED LAND PATTERN

Dimension Limits	Units	MILLIMETERS		
		MIN	NOM	MAX
Contact Pitch	E	1.27 BSC		
Contact Pad Spacing	C		5.40	
Contact Pad Width	X			0.60
Contact Pad Length	Y			1.50
Distance Between Pads	Gx	0.67		
Distance Between Pads	G	3.90		

Notes:

1. Dimensioning and tolerancing per ASME Y14.5M

BSC: Basic Dimension. Theoretically exact value shown without tolerances.

Microchip Technology Drawing No. C04-2065A

14-Lead Plastic Thin Shrink Small Outline (ST) – 4.4 mm Body [TSSOP]

Note: For the most current package drawings, please see the Microchip Packaging Specification located at <http://www.microchip.com/packaging>



Dimension Limits	Units	MILLIMETERS		
		MIN	NOM	MAX
Number of Pins	N	14		
Pitch	e	0.65 BSC		
Overall Height	A	–	–	1.20
Molded Package Thickness	A2	0.80	1.00	1.05
Standoff	A1	0.05	–	0.15
Overall Width	E	6.40 BSC		
Molded Package Width	E1	4.30	4.40	4.50
Molded Package Length	D	4.90	5.00	5.10
Foot Length	L	0.45	0.60	0.75
Footprint	L1	1.00 REF		
Foot Angle	ϕ	0°	–	8°
Lead Thickness	c	0.09	–	0.20
Lead Width	b	0.19	–	0.30

Notes:

- Pin 1 visual index feature may vary, but must be located within the hatched area.
- Dimensions D and E1 do not include mold flash or protrusions. Mold flash or protrusions shall not exceed 0.15 mm per side.
- Dimensioning and tolerancing per ASME Y14.5M.

BSC: Basic Dimension. Theoretically exact value shown without tolerances.

REF: Reference Dimension, usually without tolerance, for information purposes only.

Microchip Technology Drawing C04-087B

MCP6021/1R/2/3/4

NOTES:

APPENDIX A: REVISION HISTORY

Revision D (February 2009)

The following is the list of modifications:

1. Changed all references to 6.0V back to 5.5V throughout document.
2. **Design Aids:** Name change for Mindi Simulation Tool.
3. **Section 1.0 “Electrical Characteristics”, DC Electrical Specifications:** Corrected “Maximum Output Voltage Swing” condition from 0.9V Input Overdrive to 0.5V Input Overdrive.
4. **Section 1.0 “Electrical Characteristics”, AC Electrical Specifications:** Changed Phase Margin condition from $G = +1$ to $G = +1 V/V$.
5. **Section 1.0 “Electrical Characteristics”, AC Electrical Specifications:** Changed Settling Time, 0.2% condition from $G = +1$ to $G = +1 V/V$.
6. **Section 1.0 “Electrical Characteristics”:** Added Section 1.1 Test Circuits.
7. **Section 5.0 “Design AIDS”:** Name change for Mindi Simulation Tool. Added new boards to **Section 5.5 “Analog Demonstration and Evaluation Boards”** and new application notes to **Section 5.6 “Application Notes”**.
8. Updates **Appendix A: “Revision History”**

Revision C (March 2006)

The following is the list of modifications:

1. Added SOT-23-5 package option for single op amps MCP6021 and MCP6021R (E-temp only).
2. Added MSOP-8 package option for E-temp single op amp (MCP6021).
3. Corrected package drawing on front page for dual op amp (MCP6022).
4. Clarified spec conditions (I_{SC} , PM and THD+N) in **Section 2.0 “Typical Performance Curves”**.
5. Added **Section 3.0 “Pin Descriptions”**.
6. Updated **Section 4.0 “Applications information”** for THD+N, unused op amps, and gain peaking discussions.
7. Corrected and updated package marking information in **Section 6.0 “Packaging Information”**.
8. Added **Appendix A: “Revision History”**.

Revision B (November 2003)

- Second Release of this Document

Revision A (November 2001)

- Original Release of this Document.

MCP6021/1R/2/3/4

NOTES:

PRODUCT IDENTIFICATION SYSTEM

To order or obtain information, e.g., on pricing or delivery, refer to the factory or the listed sales office.

<u>PART NO.</u>	<u>X</u>	<u>/XX</u>	
Device	Temperature Range	Package	
Device:	MCP6021	Single Op Amp	
	MCP6021T	Single Op Amp (Tape and Reel for SOT-23, SOIC, TSSOP, MSOP)	
	MCP6021R	Single Op Amp	
	MCP6021RT	Single Op Amp (Tape and Reel for SOT-23)	
	MCP6022	Dual Op Amp	
	MCP6022T	Dual Op Amp (Tape and Reel for SOIC and TSSOP)	
	MCP6023	Single Op Amp w/ \overline{CS}	
	MCP6023T	Single Op Amp w/ \overline{CS} (Tape and Reel for SOIC and TSSOP)	
	MCP6024	Quad Op Amp	
	MCP6024T	Quad Op Amp (Tape and Reel for SOIC and TSSOP)	
Temperature Range:	I	= -40°C to +85°C	
	E	= -40°C to +125°C	
Package:	OT	= Plastic Small Outline Transistor (SOT-23), 5-lead (MCP6021, E-Temp; MCP6021R, E-Temp)	
	MS	= Plastic MSOP, 8-lead (MCP6021, E-Temp)	
	P	= Plastic DIP (300 mil Body), 8-lead, 14-lead	
	SN	= Plastic SOIC (150mil Body), 8-lead	
	SL	= Plastic SOIC (150 mil Body), 14-lead	
	ST	= Plastic TSSOP, 8-lead (MCP6021, I-Temp; MCP6022, I-Temp, E-Temp; MCP6023, I-Temp, E-Temp;)	
	ST	= Plastic TSSOP, 14-lead	

Examples:

- a) MCP6021T-E/OT: Tape and Reel, Extended temperature, 5LD SOT-23.
- b) MCP6021-E/P: Extended temperature, 8LD PDIP.
- c) MCP6021-E/SN: Extended temperature, 8LD SOIC.
- a) MCP6021RT-E/OT: Tape and Reel, Extended temperature, 5LD SOT-23.
- a) MCP6022-I/P: Industrial temperature, 8LD PDIP.
- b) MCP6022-E/P: Extended temperature, 8LD PDIP.
- c) MCP6022T-E/ST: Tape and Reel, Extended temperature, 8LD TSSOP.
- a) MCP6023-I/P: Industrial temperature, 8LD PDIP.
- b) MCP6023-E/P: Extended temperature, 8LD PDIP.
- c) MCP6023-E/SN: Extended temperature, 8LD SOIC.
- a) MCP6024-I/SL: Industrial temperature, 14LD SOIC.
- b) MCP6024-E/SL: Extended temperature, 14LD SOIC.
- c) MCP6024T-E/ST: Tape and Reel, Extended temperature, 14LD TSSOP.

MCP6021/1R/2/3/4

NOTES:

Note the following details of the code protection feature on Microchip devices:

- Microchip products meet the specification contained in their particular Microchip Data Sheet.
- Microchip believes that its family of products is one of the most secure families of its kind on the market today, when used in the intended manner and under normal conditions.
- There are dishonest and possibly illegal methods used to breach the code protection feature. All of these methods, to our knowledge, require using the Microchip products in a manner outside the operating specifications contained in Microchip's Data Sheets. Most likely, the person doing so is engaged in theft of intellectual property.
- Microchip is willing to work with the customer who is concerned about the integrity of their code.
- Neither Microchip nor any other semiconductor manufacturer can guarantee the security of their code. Code protection does not mean that we are guaranteeing the product as “unbreakable.”

Code protection is constantly evolving. We at Microchip are committed to continuously improving the code protection features of our products. Attempts to break Microchip's code protection feature may be a violation of the Digital Millennium Copyright Act. If such acts allow unauthorized access to your software or other copyrighted work, you may have a right to sue for relief under that Act.

Information contained in this publication regarding device applications and the like is provided only for your convenience and may be superseded by updates. It is your responsibility to ensure that your application meets with your specifications. MICROCHIP MAKES NO REPRESENTATIONS OR WARRANTIES OF ANY KIND WHETHER EXPRESS OR IMPLIED, WRITTEN OR ORAL, STATUTORY OR OTHERWISE, RELATED TO THE INFORMATION, INCLUDING BUT NOT LIMITED TO ITS CONDITION, QUALITY, PERFORMANCE, MERCHANTABILITY OR FITNESS FOR PURPOSE. Microchip disclaims all liability arising from this information and its use. Use of Microchip devices in life support and/or safety applications is entirely at the buyer's risk, and the buyer agrees to defend, indemnify and hold harmless Microchip from any and all damages, claims, suits, or expenses resulting from such use. No licenses are conveyed, implicitly or otherwise, under any Microchip intellectual property rights.

Trademarks

The Microchip name and logo, the Microchip logo, Accuron, dsPIC, KEELOQ, KEELOQ logo, MPLAB, PIC, PICmicro, PICSTART, rfPIC, SmartShunt and UNI/O are registered trademarks of Microchip Technology Incorporated in the U.S.A. and other countries.

FilterLab, Linear Active Thermistor, MXDEV, MXLAB, SEEVAL, SmartSensor and The Embedded Control Solutions Company are registered trademarks of Microchip Technology Incorporated in the U.S.A.

Analog-for-the-Digital Age, Application Maestro, CodeGuard, dsPICDEM, dsPICDEM.net, dsPICworks, dsSPEAK, ECAN, ECONOMONITOR, FanSense, In-Circuit Serial Programming, ICSP, ICEPIC, Mindi, MiWi, MPASM, MPLAB Certified logo, MPLIB, MPLINK, mTouch, PICkit, PICDEM, PICDEM.net, PICtail, PIC³² logo, PowerCal, PowerInfo, PowerMate, PowerTool, REAL ICE, rfLAB, Select Mode, Total Endurance, WiperLock and ZENA are trademarks of Microchip Technology Incorporated in the U.S.A. and other countries.

SQTP is a service mark of Microchip Technology Incorporated in the U.S.A.

All other trademarks mentioned herein are property of their respective companies.

© 2009, Microchip Technology Incorporated, Printed in the U.S.A., All Rights Reserved.

 Printed on recycled paper.

QUALITY MANAGEMENT SYSTEM
CERTIFIED BY DNV
== ISO/TS 16949:2002 ==

Microchip received ISO/TS-16949:2002 certification for its worldwide headquarters, design and wafer fabrication facilities in Chandler and Tempe, Arizona; Gresham, Oregon and design centers in California and India. The Company's quality system processes and procedures are for its PIC® MCUs and dsPIC® DSCs, KEELOQ® code hopping devices, Serial EEPROMs, microperipherals, nonvolatile memory and analog products. In addition, Microchip's quality system for the design and manufacture of development systems is ISO 9001:2000 certified.



Worldwide Sales and Service

AMERICAS

Corporate Office

2355 West Chandler Blvd.
Chandler, AZ 85224-6199
Tel: 480-792-7200
Fax: 480-792-7277
Technical Support:
<http://support.microchip.com>
Web Address:
www.microchip.com

Atlanta

Duluth, GA
Tel: 678-957-9614
Fax: 678-957-1455

Boston

Westborough, MA
Tel: 774-760-0087
Fax: 774-760-0088

Chicago

Itasca, IL
Tel: 630-285-0071
Fax: 630-285-0075

Cleveland

Independence, OH
Tel: 216-447-0464
Fax: 216-447-0643

Dallas

Addison, TX
Tel: 972-818-7423
Fax: 972-818-2924

Detroit

Farmington Hills, MI
Tel: 248-538-2250
Fax: 248-538-2260

Kokomo

Kokomo, IN
Tel: 765-864-8360
Fax: 765-864-8387

Los Angeles

Mission Viejo, CA
Tel: 949-462-9523
Fax: 949-462-9608

Santa Clara

Santa Clara, CA
Tel: 408-961-6444
Fax: 408-961-6445

Toronto

Mississauga, Ontario,
Canada
Tel: 905-673-0699
Fax: 905-673-6509

ASIA/PACIFIC

Asia Pacific Office

Suites 3707-14, 37th Floor
Tower 6, The Gateway
Harbour City, Kowloon
Hong Kong
Tel: 852-2401-1200
Fax: 852-2401-3431

Australia - Sydney

Tel: 61-2-9868-6733
Fax: 61-2-9868-6755

China - Beijing

Tel: 86-10-8528-2100
Fax: 86-10-8528-2104

China - Chengdu

Tel: 86-28-8665-5511
Fax: 86-28-8665-7889

China - Hong Kong SAR

Tel: 852-2401-1200
Fax: 852-2401-3431

China - Nanjing

Tel: 86-25-8473-2460
Fax: 86-25-8473-2470

China - Qingdao

Tel: 86-532-8502-7355
Fax: 86-532-8502-7205

China - Shanghai

Tel: 86-21-5407-5533
Fax: 86-21-5407-5066

China - Shenyang

Tel: 86-24-2334-2829
Fax: 86-24-2334-2393

China - Shenzhen

Tel: 86-755-8203-2660
Fax: 86-755-8203-1760

China - Wuhan

Tel: 86-27-5980-5300
Fax: 86-27-5980-5118

China - Xiamen

Tel: 86-592-2388138
Fax: 86-592-2388130

China - Xian

Tel: 86-29-8833-7252
Fax: 86-29-8833-7256

China - Zhuhai

Tel: 86-756-3210040
Fax: 86-756-3210049

ASIA/PACIFIC

India - Bangalore

Tel: 91-80-3090-4444
Fax: 91-80-3090-4080

India - New Delhi

Tel: 91-11-4160-8631
Fax: 91-11-4160-8632

India - Pune

Tel: 91-20-2566-1512
Fax: 91-20-2566-1513

Japan - Yokohama

Tel: 81-45-471- 6166
Fax: 81-45-471-6122

Korea - Daegu

Tel: 82-53-744-4301
Fax: 82-53-744-4302

Korea - Seoul

Tel: 82-2-554-7200
Fax: 82-2-558-5932 or
82-2-558-5934

Malaysia - Kuala Lumpur

Tel: 60-3-6201-9857
Fax: 60-3-6201-9859

Malaysia - Penang

Tel: 60-4-227-8870
Fax: 60-4-227-4068

Philippines - Manila

Tel: 63-2-634-9065
Fax: 63-2-634-9069

Singapore

Tel: 65-6334-8870
Fax: 65-6334-8850

Taiwan - Hsin Chu

Tel: 886-3-572-9526
Fax: 886-3-572-6459

Taiwan - Kaohsiung

Tel: 886-7-536-4818
Fax: 886-7-536-4803

Taiwan - Taipei

Tel: 886-2-2500-6610
Fax: 886-2-2508-0102

Thailand - Bangkok

Tel: 66-2-694-1351
Fax: 66-2-694-1350

EUROPE

Austria - Wels

Tel: 43-7242-2244-39
Fax: 43-7242-2244-393

Denmark - Copenhagen

Tel: 45-4450-2828
Fax: 45-4485-2829

France - Paris

Tel: 33-1-69-53-63-20
Fax: 33-1-69-30-90-79

Germany - Munich

Tel: 49-89-627-144-0
Fax: 49-89-627-144-44

Italy - Milan

Tel: 39-0331-742611
Fax: 39-0331-466781

Netherlands - Drunen

Tel: 31-416-690399
Fax: 31-416-690340

Spain - Madrid

Tel: 34-91-708-08-90
Fax: 34-91-708-08-91

UK - Wokingham

Tel: 44-118-921-5869
Fax: 44-118-921-5820



Стандарт Электрон Связь

Мы молодая и активно развивающаяся компания в области поставок электронных компонентов. Мы поставляем электронные компоненты отечественного и импортного производства напрямую от производителей и с крупнейших складов мира.

Благодаря сотрудничеству с мировыми поставщиками мы осуществляем комплексные и плановые поставки широчайшего спектра электронных компонентов.

Собственная эффективная логистика и склад в обеспечивает надежную поставку продукции в точно указанные сроки по всей России.

Мы осуществляем техническую поддержку нашим клиентам и предпродажную проверку качества продукции. На все поставляемые продукты мы предоставляем гарантию .

Осуществляем поставки продукции под контролем ВП МО РФ на предприятия военно-промышленного комплекса России , а также работаем в рамках 275 ФЗ с открытием отдельных счетов в уполномоченном банке. Система менеджмента качества компании соответствует требованиям ГОСТ ISO 9001.

Минимальные сроки поставки, гибкие цены, неограниченный ассортимент и индивидуальный подход к клиентам являются основой для выстраивания долгосрочного и эффективного сотрудничества с предприятиями радиоэлектронной промышленности, предприятиями ВПК и научно-исследовательскими институтами России.

С нами вы становитесь еще успешнее!

Наши контакты:

Телефон: +7 812 627 14 35

Электронная почта: sales@st-electron.ru

Адрес: 198099, Санкт-Петербург,
Промышленная ул, дом № 19, литера Н,
помещение 100-Н Офис 331