

# ZXMS6003G

## 60V N-channel self protected enhancement mode IntelliFET™ MOSFET with programmable current limit

### Summary

<b>Continuous drain source voltage</b>	<b><math>V_{DS} = 60V</math></b>
<b>On-state resistance</b>	<b>500mΩ</b>
<b>Nominal load current (<math>V_{IN} = 5V</math>)</b>	<b>1.4A</b>
<b>Clamping energy</b>	<b>550mJ</b>

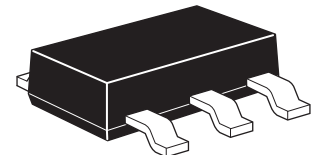

### Description

Self protected low side MOSFET. Monolithic over temperature, over current, over voltage (active clamp) and ESD protected logic level functionality. Intended as a general purpose switch, with status indication and programmable current limit.

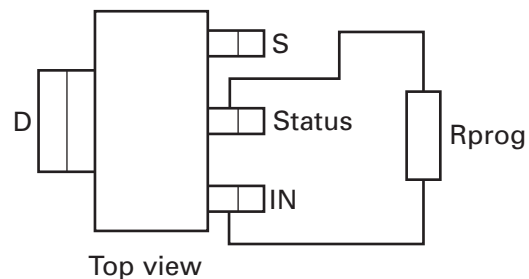

**Note:** Rprog must be connected between the Status and IN pins

### Features

- Current limit programmable via external resistor
- Status pin (analog status indication)
- Short circuit protection with auto restart
- Over voltage protection (active clamp)
- Thermal shutdown with auto restart
- Over-current protection
- Input Protection (ESD)
- Load dump protection (actively protects load)
- Logic Level Input
- High continuous current rating

### Ordering information

Device	Part mark	Reel size (inches)	Tape width (mm)	Quantity per reel
ZXMS6003GTA	ZXMS6003	7	12	1,000

## Functional block diagram

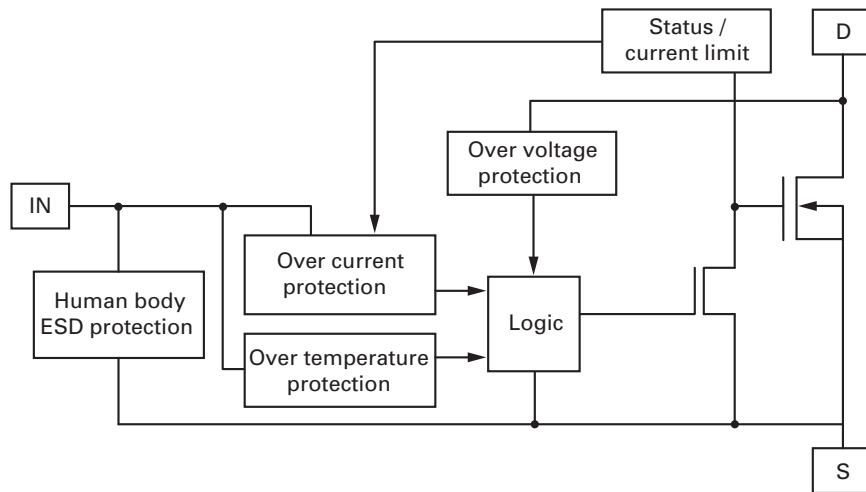

## Applications and information

- Especially suited for loads with a high in-rush current such as lamps and motors.
  - All types of resistive, inductive and capacitive loads in switching applications.
  - $\mu\text{C}$  compatible power switch for 12V and 24V DC applications.
  - Automotive rated.
  - Replaces electromechanical relays and discrete circuits.
  - Linear mode capability - the current-limiting protection circuitry is designed to de-activate at low  $V_{\text{DS}}$ , in order not to compromise the load current during normal operation. The design max. DC operating current is therefore determined by the thermal capability of the package/board combination, rather than by the protection circuitry.
- Note:** This does not compromise the product's ability to self-protect during short-circuit load conditions.
- The current limit is programmable via an external resistor  $R_{\text{prog}}$  connected between Status and IN pins.
  - Status pin voltage reflects the gate drive being applied internally to the power MOSFET.  
 With  $V_{\text{IN}} = 5\text{V}$  and  $R_{\text{prog}} = 24\text{k}\Omega$ :  
 Status voltage  $\sim 5\text{V}$  indicates normal operation.  
 Status voltage  $\sim (2-3)\text{V}$  indicates that the device is in current-limiting mode.  
 Status voltage  $< 1\text{V}$  indicates that the device is in thermal shutdown.

**Current Limiting and Over Temp Shutdown Status Indication at Vin=5V**

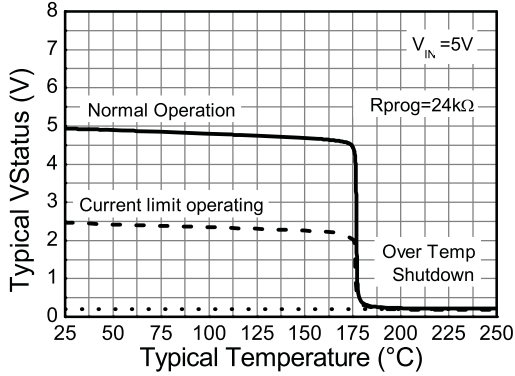

**Current Limiting and Over Temp Shutdown Status Indication at Vin=10V**

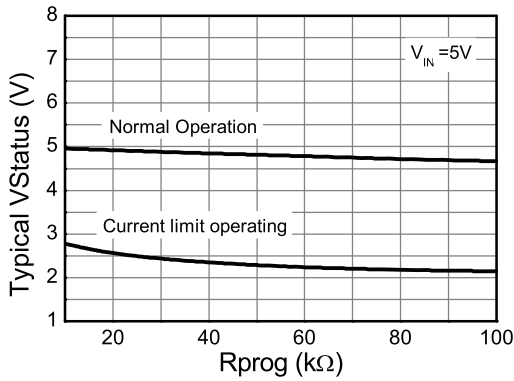
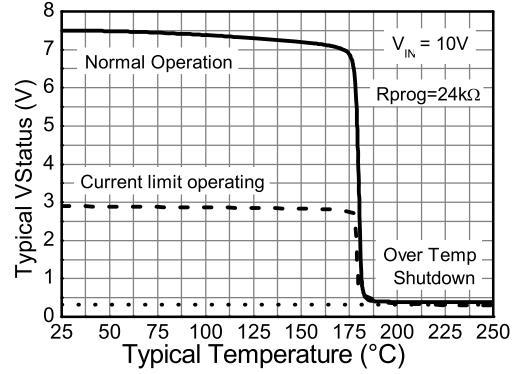

**VStatus vs Rprog @ Vin=5V**

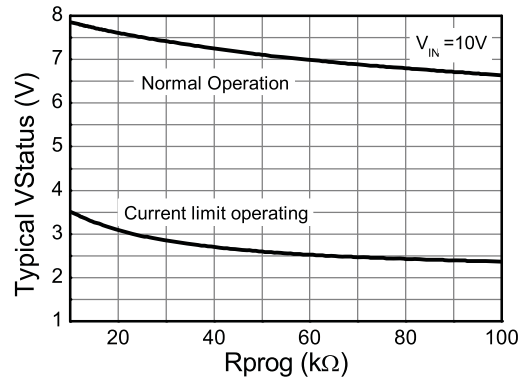

**VStatus vs Rprog @ Vin=10V**

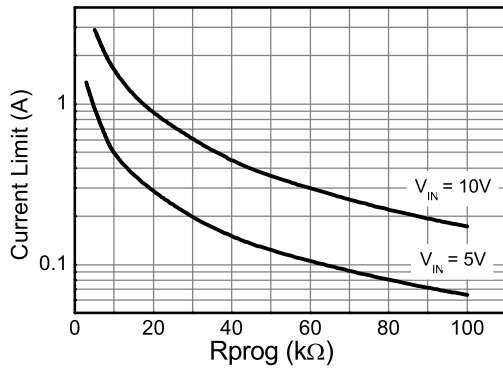

**Current Limit vs Rprog**

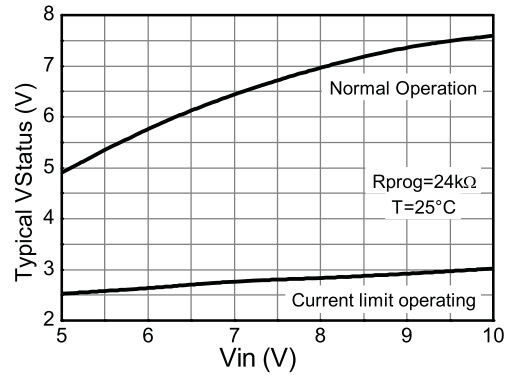

**VStatus vs Vin**

## Absolute maximum ratings

Parameter	Symbol	Limit	Unit
Continuous drain-source voltage	$V_{DS}$	60	V
Drain-source voltage for short circuit protection $V_{IN}=5V^{(a)}$	$V_{DS(SC)}$	36	V
Drain-source voltage for short circuit protection $V_{IN}=10V^{(a)}$	$V_{DS(SC)}$	20	V
Continuous input voltage	$V_{IN}$	-0.2 ... +10	V
Peak input voltage	$V_{IN}$	-0.2 ... +20	V
Operating temperature range	$T_{j,r}$	-40 to +150	°C
Storage temperature range	$T_{stg}$	-55 to +150	°C
Power dissipation @ $T_{amb}=25^{\circ}C^{(a)}$	$P_D$	2.5	W
Continuous drain current @ $V_{IN}=10V$ ; $T_{amb}=25^{\circ}C^{(b)}$	$I_D$	1.6	A
Continuous drain current @ $V_{IN}=5V$ ; $T_{amb}=25^{\circ}C^{(b)}$	$I_D$	1.4	A
Continuous source current (body diode) <sup>(b)</sup>	$I_S$	3	A
Pulsed source current (body diode) <sup>(c)</sup>	$I_S$	8	A
Unclamped single pulse inductive energy	$E_{AS}$	550	mJ
Load dump protection	$V_{LoadDump}$	80	V
Electrostatic discharge (human body model)	$V_{ESD}$	4000	V
DIN humidity category, DIN 40 040		E	
IEC climatic category, DIN IEC 68-1		40/150/56	

## Thermal resistance

Parameter	Symbol	Limit	Unit
Junction to ambient	$R_{\theta JA}$	50	°C/W
Junction to ambient	$R_{\theta JA}$	28	°C/W

### NOTES:

(a) For  $I_{D(LIM)} < 1.2A$  (see safe operating area curve).

(b) For a device surface mounted on 50mm x 50mm x 1.6mm FR4 board with a high coverage of single sided 2oz weight copper.

(c) For a device surface mounted on FR4 board and measured at  $t \leq 10s$ .

## Characteristics

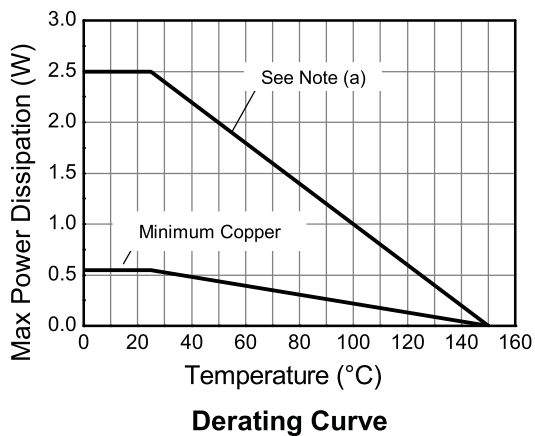
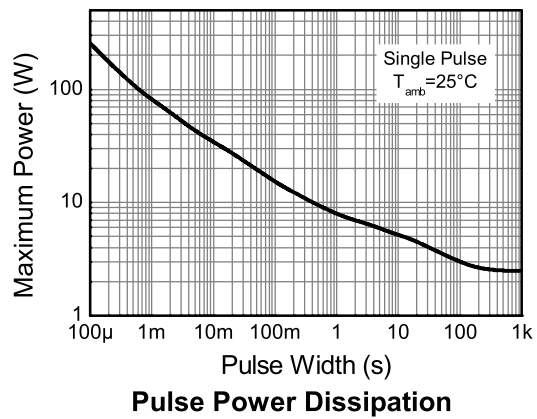
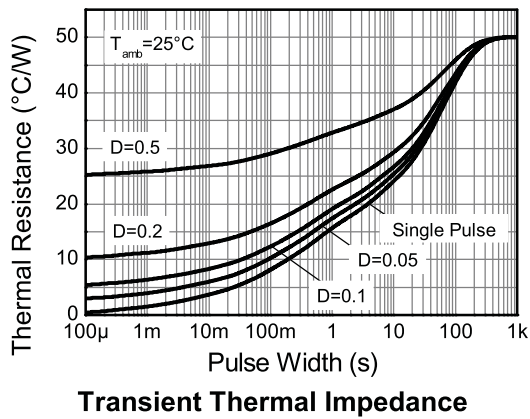
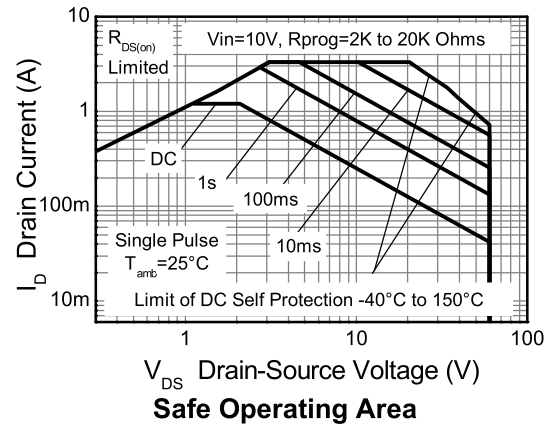
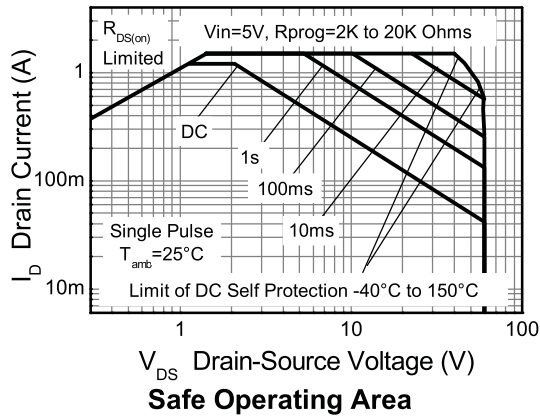

# ZXMS6003G

## Electrical characteristics (at $T_{amb} = 25^{\circ}\text{C}$ unless otherwise stated)

Parameter	Symbol	Min	Typ	Max	Unit	Conditions
<b>Static Characteristics</b>						
Drain-source clamp voltage	$V_{DS(AZ)}$	60	70	75	V	$I_D=10\text{mA}$
Off state drain current	$I_{DSS}$		0.1	3	$\mu\text{A}$	$V_{DS}=12\text{V}, V_{IN}=0\text{V}$
Off state drain current	$I_{DSS}$		3	15	$\mu\text{A}$	$V_{DS}=32\text{V}, V_{IN}=0\text{V}$
Input threshold voltage (*)	$V_{IN(th)}$	1	2.1		V	$V_{DS}=V_{GS}, I_D=1\text{mA}$
Input current	$I_{IN}$		0.7	1.2	mA	$V_{IN}=+5\text{V}$
Input current	$I_{IN}$		1.5	2.7	mA	$V_{IN}=+7\text{V}$
Input current	$I_{IN}$		4	7	mA	$V_{IN}=+10\text{V}$
Static drain-source on-state resistance	$R_{DS(on)}$		520	675	$\text{m}\Omega$	$V_{IN}=5\text{V}, I_D=0.2\text{A}$
Static drain-source on-state resistance	$R_{DS(on)}$		385	500	$\text{m}\Omega$	$V_{IN}=10\text{V}, I_D=0.5\text{A}$
Current limit (†)	$I_{D(LIM)}$	0.2	0.3	0.4	A	$V_{IN}=5\text{V}, V_{ds}=10\text{V}$ $R_{prog}=20\text{k}$
Current limit(†)	$I_{D(LIM)}$	0.7	0.9	1.2	A	$V_{IN}=10\text{V}, V_{ds}=10\text{V},$ $R_{prog}=20\text{k}$
<b>Dynamic characteristics</b>						
Turn-on time ( $V_{IN}$ to 90% $I_D$ )	$t_{on}$		3.0	10	$\mu\text{s}$	$R_{prog}=20\text{k}, R_L=22\Omega,$ $V_{IN}=0$ to 10V, $V_{DD}=12\text{V}$
Turn-off time ( $V_{IN}$ to 90% $I_D$ )	$t_{off}$		13	20	$\mu\text{s}$	$R_{prog}=20\text{k}, R_L=22\Omega,$ $V_{IN}=10\text{V}$ to 0V, $V_{DD}=12\text{V}$
Slew rate on (70 to 50% $V_{DD}$ )	$-dV_{DS}/dt_{on}$		8	20	V/ $\mu\text{s}$	$R_{prog}=20\text{k}, R_L=22\Omega,$ $V_{IN}=0$ to 10V, $V_{DD}=12\text{V}$
Slew rate off (50 to 70% $V_{DD}$ )	$DV_{DS}/dt_{on}$		3.2	10	V/ $\mu\text{s}$	$R_{prog}=20\text{k}, R_L=22\Omega,$ $V_{IN}=10\text{V}$ to 0V, $V_{DD}=12\text{V}$

### NOTES:

(\*) Protection features may operate outside spec for  $V_{IN}<4.5\text{V}$

(†) The drain current is limited to a reduced value when  $V_{ds}$  exceeds a safe level.

# ZXMS6003G

## Electrical characteristics (at $T_{amb} = 25^{\circ}\text{C}$ unless otherwise stated) (cont.)

Parameter	Symbol	Min	Typ	Max	Unit	Conditions
<b>Protection functions<sup>(‡)</sup></b>						
Required input voltage for over temperature protection	$V_{PROT}$	4.5			V	
Thermal overload trip temperature	$T_{JT}$	150	175		$^{\circ}\text{C}$	
Thermal hysteresis			1		$^{\circ}\text{C}$	
Unclamped single pulse inductive energy $T_j=25^{\circ}\text{C}$	$E_{AS}$	550			mJ	$I_{D(ISO)}=0.7\text{A}$ , $V_{DD}=32\text{V}$
Unclamped single pulse inductive energy $T_j=150^{\circ}\text{C}$	$E_{AS}$	200			mJ	$I_{D(ISO)}=0.7\text{A}$ , $V_{DD}=32\text{V}$
<b>Status flag</b>						
Normal operation	$V_{STATUS}$		4.95		V	$V_{IN} = 5\text{V}$
Current limit operating	$V_{STATUS}$		2.5		V	$V_{IN} = 5\text{V}$
Thermal shutdown activated	$V_{STATUS}$		0.2	1	V	$V_{IN} = 5\text{V}$
Normal operation	$V_{STATUS}$		8.0		V	$V_{IN} = 10\text{V}$
Current limit operation	$V_{STATUS}$		3.0		V	$V_{IN} = 10\text{V}$
Thermal shutdown activated	$V_{STATUS}$		0.35	1	V	$V_{IN} = 10\text{V}$
<b>Inverse diode</b>						
Source drain voltage	$V_{SD}$			1	V	$V_{IN}=0\text{V}$ , $-I_D=1.4\text{A}$

### NOTES:

(‡) Integrated protection functions are designed to prevent IC destruction under fault conditions described in the datasheet. Fault conditions are considered as "outside" normal operating range. Protection functions are not designed for continuous, repetitive operation.

## Typical characteristics

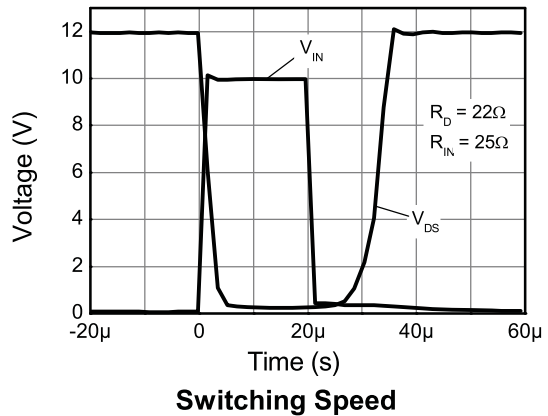
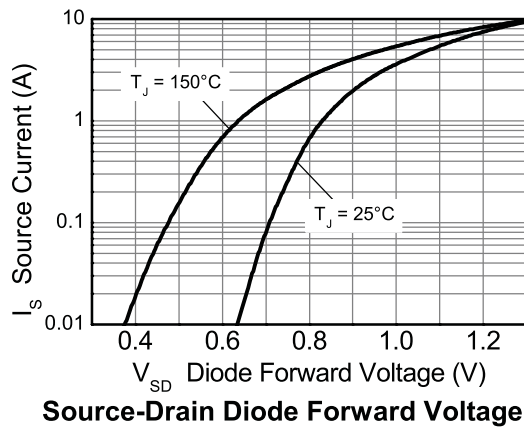
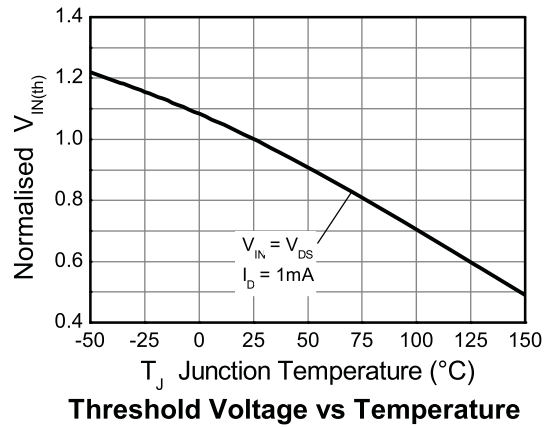
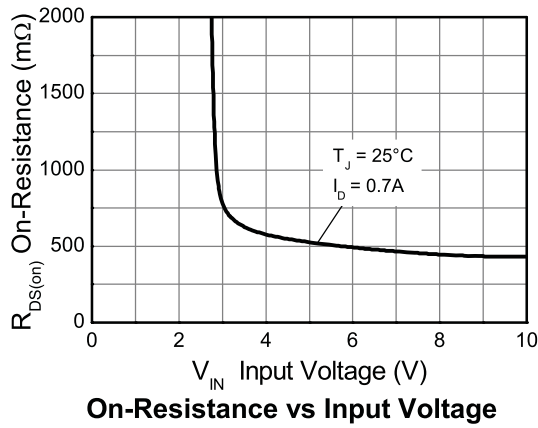
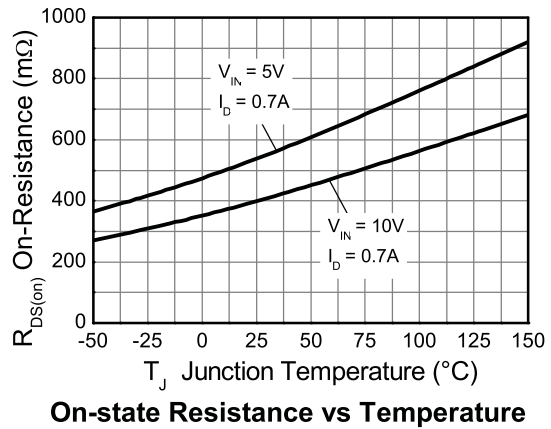
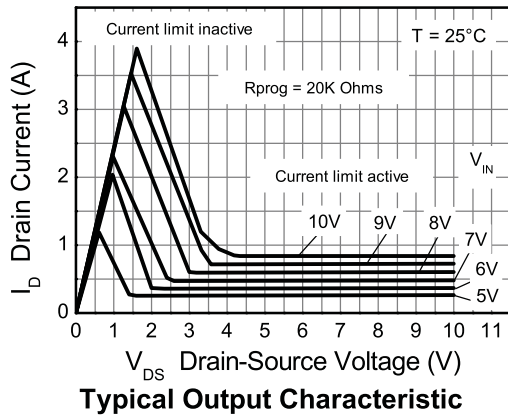

# ZXMS6003G

## Package outline - SOT223

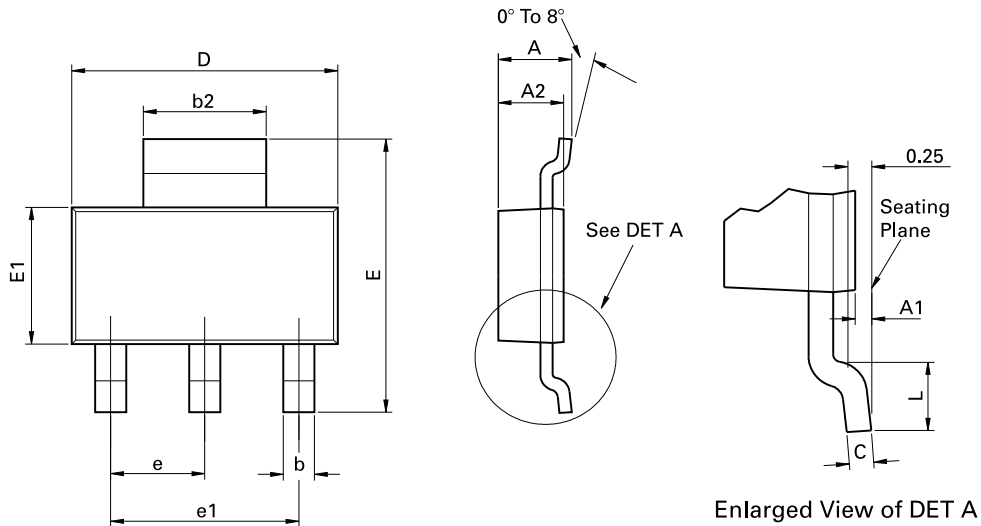

Conforms to JEDEC TO-261 AA Issue B

DIM	Millimeters		Inches		DIM	Millimeters		Inches	
	Min	Max	Min	Max		Min	Max	Min	Max
A	-	1.80	-	0.071	e	2.30 BSC		0.0905 BSC	
A1	0.02	0.10	0.0008	0.004	e1	4.60 BSC		0.181 BSC	
b	0.66	0.84	0.026	0.033	E	6.70	7.30	0.264	0.287
b2	2.90	3.10	0.114	0.122	E1	3.30	3.70	0.130	0.146
C	0.23	0.33	0.009	0.013	L	0.90	-	0.355	-
D	6.30	6.70	0.248	0.264	-	-	-	-	-

**Note:** Controlling dimensions are in millimeters. Approximate dimensions are provided in inches

## Definitions

### Product change

Zetex Semiconductors reserves the right to alter, without notice, specifications, design, price or conditions of supply of any product or service. Customers are solely responsible for obtaining the latest relevant information before placing orders.

### Applications disclaimer

The circuits in this design/application note are offered as design ideas. It is the responsibility of the user to ensure that the circuit is fit for the user's application and meets with the user's requirements. No representation or warranty is given and no liability whatsoever is assumed by Zetex with respect to the accuracy or use of such information, or infringement of patents or other intellectual property rights arising from such use or otherwise. Zetex does not assume any legal responsibility or will not be held legally liable (whether in contract, tort (including negligence), breach of statutory duty, restriction or otherwise) for any damages, loss of profit, business, contract, opportunity or consequential loss in the use of these circuit applications, under any circumstances.

### Life support

Zetex products are specifically not authorized for use as critical components in life support devices or systems without the express written approval of the Chief Executive Officer of Zetex Semiconductors plc. As used herein:

A. Life support devices or systems are devices or systems which:

1. are intended to implant into the body

or

2. support or sustain life and whose failure to perform when properly used in accordance with instructions for use provided in the labelling can be reasonably expected to result in significant injury to the user.

B. A critical component is any component in a life support device or system whose failure to perform can be reasonably expected to cause the failure of the life support device or to affect its safety or effectiveness.

### Reproduction

The product specifications contained in this publication are issued to provide outline information only which (unless agreed by the company in writing) may not be used, applied or reproduced for any purpose or form part of any order or contract or be regarded as a representation relating to the products or services concerned.

### Terms and Conditions

All products are sold subjects to Zetex' terms and conditions of sale, and this disclaimer (save in the event of a conflict between the two when the terms of the contract shall prevail) according to region, supplied at the time of order acknowledgement.

For the latest information on technology, delivery terms and conditions and prices, please contact your nearest Zetex sales office.

### Quality of product

Zetex is an ISO 9001 and TS16949 certified semiconductor manufacturer.

To ensure quality of service and products we strongly advise the purchase of parts directly from Zetex Semiconductors or one of our regionally authorized distributors. For a complete listing of authorized distributors please visit: [www.zetex.com/salesnetwork](http://www.zetex.com/salesnetwork)

Zetex Semiconductors does not warrant or accept any liability whatsoever in respect of any parts purchased through unauthorized sales channels.

### ESD (Electrostatic discharge)

Semiconductor devices are susceptible to damage by ESD. Suitable precautions should be taken when handling and transporting devices. The possible damage to devices depends on the circumstances of the handling and transporting, and the nature of the device. The extent of damage can vary from immediate functional or parametric malfunction to degradation of function or performance in use over time. Devices suspected of being affected should be replaced.

### Green compliance

Zetex Semiconductors is committed to environmental excellence in all aspects of its operations which includes meeting or exceeding regulatory requirements with respect to the use of hazardous substances. Numerous successful programs have been implemented to reduce the use of hazardous substances and/or emissions.

All Zetex components are compliant with the RoHS directive, and through this it is supporting its customers in their compliance with WEEE and ELV directives.

### Product status key:

"Preview"	Future device intended for production at some point. Samples may be available
"Active"	Product status recommended for new designs
"Last time buy (LTB)"	Device will be discontinued and last time buy period and delivery is in effect
"Not recommended for new designs"	Device is still in production to support existing designs and production
"Obsolete"	Production has been discontinued

### Datasheet status key:

"Draft version"	This term denotes a very early datasheet version and contains highly provisional information, which may change in any manner without notice.
"Provisional version"	This term denotes a pre-release datasheet. It provides a clear indication of anticipated performance. However, changes to the test conditions and specifications may occur, at any time and without notice.
"Issue"	This term denotes an issued datasheet containing finalized specifications. However, changes to specifications may occur, at any time and without notice.

### Zetex sales offices

Europe	Americas	Asia Pacific	Corporate Headquarters
Zetex GmbH Kustermann-park Balanstraße 59 D-81541 München Germany Telephone: (49) 89 45 49 49 0 Fax: (49) 89 45 49 49 49 europe.sales@zetex.com	Zetex Inc 700 Veterans Memorial Highway Hauppauge, NY 11788 USA Telephone: (1) 631 360 2222 Fax: (1) 631 360 8222 usa.sales@zetex.com	Zetex (Asia Ltd) 3701-04 Metroplaza Tower 1 Hing Fong Road, Kwai Fong Hong Kong Telephone: (852) 26100 611 Fax: (852) 24250 494 asia.sales@zetex.com	Zetex Semiconductors plc Zetex Technology Park, Chadderton Oldham, OL9 9LL United Kingdom Telephone: (44) 161 622 4444 Fax: (44) 161 622 4446 hq@zetex.com

© 2007 Published by Zetex Semiconductors plc



## Стандарт Электрон Связь

Мы молодая и активно развивающаяся компания в области поставок электронных компонентов. Мы поставляем электронные компоненты отечественного и импортного производства напрямую от производителей и с крупнейших складов мира.

Благодаря сотрудничеству с мировыми поставщиками мы осуществляем комплексные и плановые поставки широчайшего спектра электронных компонентов.

Собственная эффективная логистика и склад в обеспечивает надежную поставку продукции в точно указанные сроки по всей России.

Мы осуществляем техническую поддержку нашим клиентам и предпродажную проверку качества продукции. На все поставляемые продукты мы предоставляем гарантию .

Осуществляем поставки продукции под контролем ВП МО РФ на предприятия военно-промышленного комплекса России , а также работаем в рамках 275 ФЗ с открытием отдельных счетов в уполномоченном банке. Система менеджмента качества компании соответствует требованиям ГОСТ ISO 9001.

Минимальные сроки поставки, гибкие цены, неограниченный ассортимент и индивидуальный подход к клиентам являются основой для выстраивания долгосрочного и эффективного сотрудничества с предприятиями радиоэлектронной промышленности, предприятиями ВПК и научно-исследовательскими институтами России.

С нами вы становитесь еще успешнее!

### Наши контакты:

**Телефон:** +7 812 627 14 35

**Электронная почта:** [sales@st-electron.ru](mailto:sales@st-electron.ru)

**Адрес:** 198099, Санкт-Петербург,  
Промышленная ул, дом № 19, литера Н,  
помещение 100-Н Офис 331