



Is Now Part of



**ON Semiconductor®**

To learn more about ON Semiconductor, please visit our website at  
[www.onsemi.com](http://www.onsemi.com)

Please note: As part of the Fairchild Semiconductor integration, some of the Fairchild orderable part numbers will need to change in order to meet ON Semiconductor's system requirements. Since the ON Semiconductor product management systems do not have the ability to manage part nomenclature that utilizes an underscore (\_), the underscore (\_) in the Fairchild part numbers will be changed to a dash (-). This document may contain device numbers with an underscore (\_). Please check the ON Semiconductor website to verify the updated device numbers. The most current and up-to-date ordering information can be found at [www.onsemi.com](http://www.onsemi.com). Please email any questions regarding the system integration to [Fairchild\\_questions@onsemi.com](mailto:Fairchild_questions@onsemi.com).

ON Semiconductor and the ON Semiconductor logo are trademarks of Semiconductor Components Industries, LLC dba ON Semiconductor or its subsidiaries in the United States and/or other countries. ON Semiconductor owns the rights to a number of patents, trademarks, copyrights, trade secrets, and other intellectual property. A listing of ON Semiconductor's product/patent coverage may be accessed at [www.onsemi.com/site/pdf/Patent-Marking.pdf](http://www.onsemi.com/site/pdf/Patent-Marking.pdf). ON Semiconductor reserves the right to make changes without further notice to any products herein. ON Semiconductor makes no warranty, representation or guarantee regarding the suitability of its products for any particular purpose, nor does ON Semiconductor assume any liability arising out of the application or use of any product or circuit, and specifically disclaims any and all liability, including without limitation special, consequential or incidental damages. Buyer is responsible for its products and applications using ON Semiconductor products, including compliance with all laws, regulations and safety requirements or standards, regardless of any support or applications information provided by ON Semiconductor. "Typical" parameters which may be provided in ON Semiconductor data sheets and/or specifications can and do vary in different applications and actual performance may vary over time. All operating parameters, including "Typicals" must be validated for each customer application by customer's technical experts. ON Semiconductor does not convey any license under its patent rights nor the rights of others. ON Semiconductor products are not designed, intended, or authorized for use as a critical component in life support systems or any FDA Class 3 medical devices or medical devices with a same or similar classification in a foreign jurisdiction or any devices intended for implantation in the human body. Should Buyer purchase or use ON Semiconductor products for any such unintended or unauthorized application, Buyer shall indemnify and hold ON Semiconductor and its officers, employees, subsidiaries, affiliates, and distributors harmless against all claims, costs, damages, and expenses, and reasonable attorney fees arising out of, directly or indirectly, any claim of personal injury or death associated with such unintended or unauthorized use, even if such claim alleges that ON Semiconductor was negligent regarding the design or manufacture of the part. ON Semiconductor is an Equal Opportunity/Affirmative Action Employer. This literature is subject to all applicable copyright laws and is not for resale in any manner.



# FAN73893 3-Phase Half-Bridge Gate-Drive IC

## Features

- Floating Channel for Bootstrap Operation to +600 V
- Typically 350 mA/650 mA Sourcing/Sinking Current-Driving Capability for All Channels
- Extended Allowable Negative  $V_S$  Swing to -9.8 V for Signal Propagation at  $V_{DD}=V_{BS}=15$  V
- Outputs Out of Phase with Input Signals
- Over-Current Shutdown Turns Off All Six Drivers
- Matched Propagation Delay for All Channels
- 3.3 V and 5.0 V Input Logic Compatible
- Adjustable Fault-Clear Timing
- Signal Interlocking of Every Phase to Prevent Cross-Conduction
- Common-Mode  $dV_S/dt$  Noise-Canceling Circuit
- Built-in Advanced Input Filter
- Built-in Soft Turn-Off Function
- Built-in UVLO Functions for All Channels

## Description

The FAN73893 is a monolithic three-phase half-bridge gate-drive IC designed for high-voltage, high-speed, driving MOSFETs and IGBTs operating up to +600 V.

Fairchild's high-voltage process and common-mode noise-canceling technique provide stable operation of high-side drivers under high- $dV_S/dt$  noise circumstances.

An advanced level-shift circuit allows high-side gate driver operation up to  $V_S = -9.8$  V (typical) for  $V_{BS} = 15$  V.

The protection functions include under-voltage lockout, inter-lock function and inverter over-current trip with an automatic fault-clear function. Over-current protection that terminates all six outputs can be derived from an external current-sense resistor. An open-drain fault signal is provided to indicate that an over-current or under-voltage shutdown has occurred. The UVLO circuits prevent malfunction when  $V_{DD}$  and  $V_{BS}$  are lower than the threshold voltage.

Output drivers typically source and sink 350 mA and 650 mA, respectively; which is suitable for three-phase half-bridge applications in motor drive systems.

## Applications

- 3-Phase Motor Inverter Driver
- Air Conditioner, Washing Machine, Refrigerator, Dish Washer
- Industrial Inverter – Sewing Machine, Power Tool
- General-Purpose Three-Phase Inverter

## 28-SOIC



## Ordering Information

Part Number	Package	Operating Temperature	Packing Method
FAN73893MX <sup>(1)</sup>	28-Lead, Small Outline Integrated Circuit, (SOIC)	-40 to +125°C	Tape & Reel

### Note:

1. These devices passed wave-soldering test by JESD22A-111.

### Typical Application Diagram

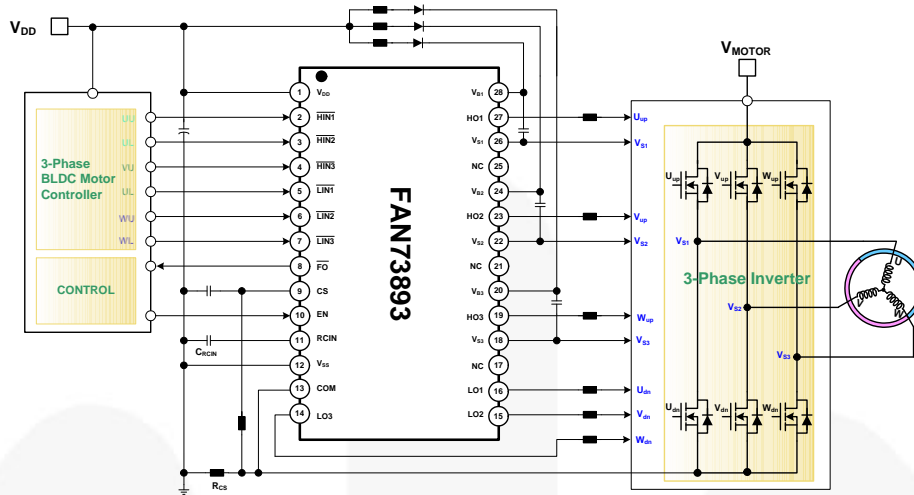

Figure 1. 3-Phase BLDC Motor Drive Application

### Internal Block Diagram

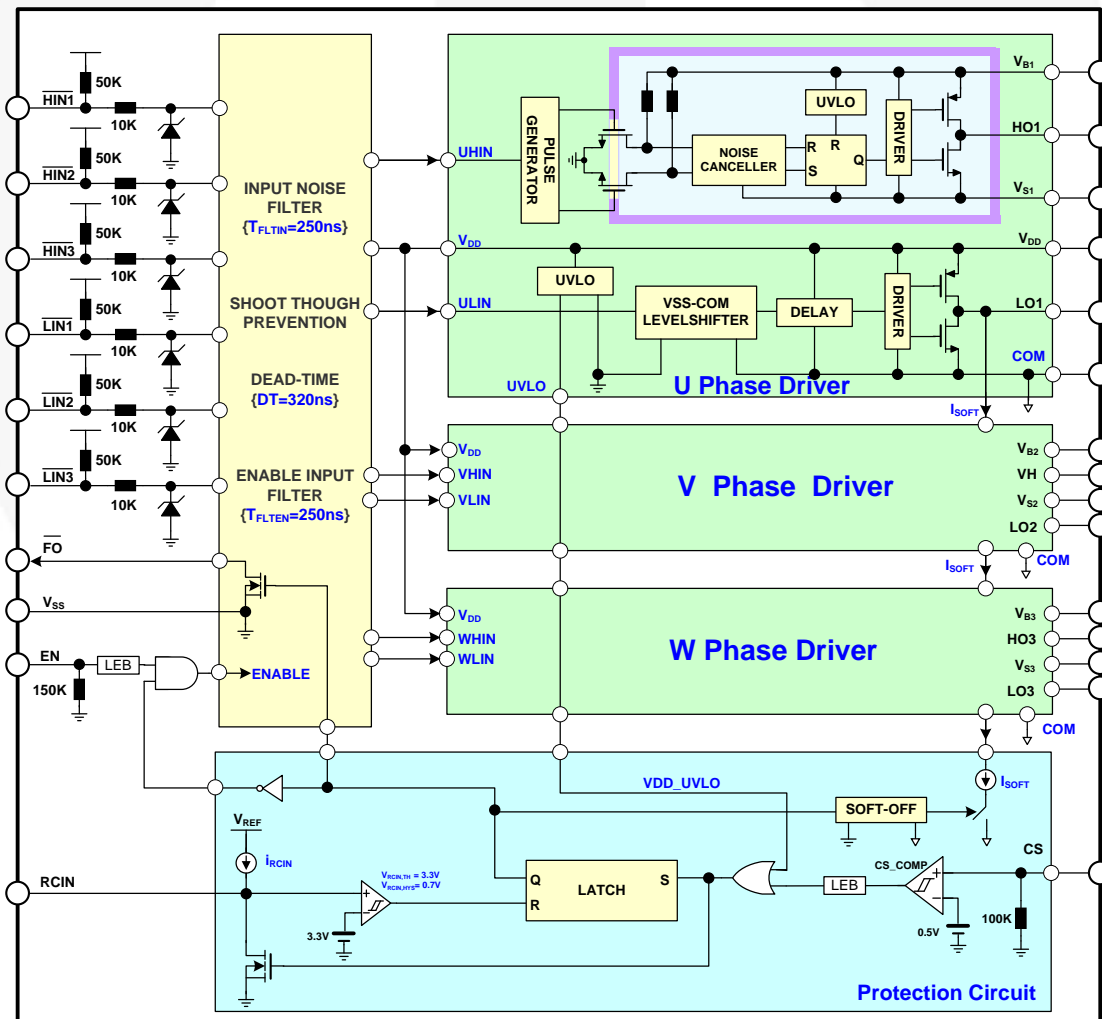

Figure 2. Functional Block Diagram

## Pin Configuration

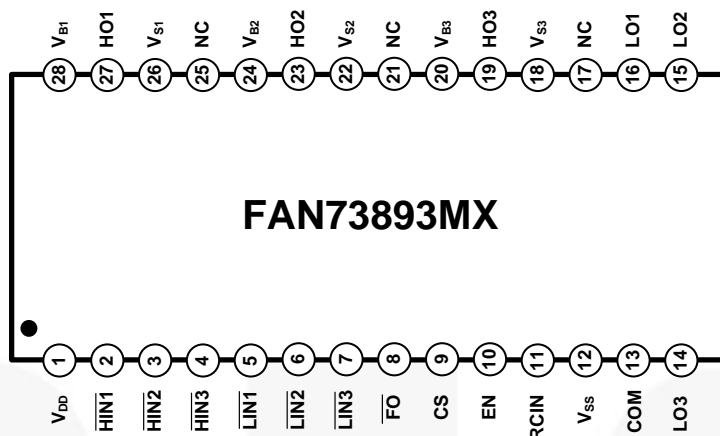

Figure 3. Pin Assignments

## Pin Definitions

Pin	Name	Description
1	$V_{DD}$	Logic and low-side gate driver power supply voltage
2	$\overline{HIN1}$	Logic Input 1 for high-side gate 1 driver
3	$\overline{HIN2}$	Logic Input 2 for high-side gate 2 driver
4	$\overline{HIN3}$	Logic Input 3 for high-side gate 3 driver
5	$\overline{LIN1}$	Logic Input 1 for low-side gate 1 driver
6	$\overline{LIN2}$	Logic Input 2 for low-side gate 2 driver
7	$\overline{LIN3}$	Logic Input 3 for low-side gate 3 driver
8	$\overline{FO}$	Fault output with open drain (indicates over-current and low-side under-voltage)
9	CS	Analog input for over-current shutdown
10	EN	Logic input for shutdown functionality
11	RCIN	An external RC network input used to define the fault-clear delay
12	$V_{SS}$	Logic ground
13	COM	Low-side driver return
14	LO3	Low-side gate driver 3 output
15	LO2	Low-side gate driver 2 output
16	LO1	Low-side gate driver 1 output
17, 21, 25	NC	No connect
18	$V_{S3}$	High-side driver 3 floating supply offset voltage
19	HO3	High-side driver 3 gate driver output
20	$V_{B3}$	High-side driver 3 floating supply
22	$V_{S2}$	High-side driver 2 floating supply offset voltage
23	HO2	High-side driver 2 gate driver output
24	$V_{B2}$	High-side driver 2 floating supply
26	$V_{S1}$	High-side driver 1 floating supply offset voltage
27	HO1	High-side driver 1 gate driver output
28	$V_{B1}$	High-side driver 1 floating supply

## Absolute Maximum Ratings

Stresses exceeding the Absolute Maximum Ratings may damage the device. The device may not function or be operable above the recommended operating conditions and stressing the parts to these levels is not recommended. In addition, extended exposure to stresses above the recommended operating conditions may affect device reliability. The absolute maximum ratings are stress ratings only.  $T_A=25^{\circ}\text{C}$ , unless otherwise specified.

Symbol	Parameter	Min.	Max.	Unit
$V_S$	High-Side Floating Offset Voltage	$V_{B1,2,3}-25$	$V_{B1,2,3}+0.3$	V
$V_B$	High-Side Floating Supply Voltage	-0.3	625.0	V
$V_{DD}$	Low-Side and Logic-Fixed supply voltage	-0.3	25.0	V
$V_{HO}$	High-Side Floating Output Voltage $V_{HO1,2,3}$	$V_{S1,2,3}-0.3$	$V_{B1,2,3}+0.3$	V
$V_{LO}$	Low-Side Floating Output Voltage $V_{LO1,2,3}$	-0.3	$V_{DD}+0.3$	V
$V_{IN}$	Input Voltage ( $\overline{HINx}$ , $\overline{LINx}$ , CS, and EN) <sup>(2)</sup>	$V_{SS} - 0.3$	$V_{SS} + 5.5$	V
$V_{FO}$	Fault Output Voltage ( $\overline{FO}$ )	-0.3	$V_{DD}+0.3$	V
dVs/dt	Allowable Offset Voltage Slew Rate		$\pm 50$	V/ns
$P_D$	Power Dissipation <sup>(3,4)</sup>		1.4	W
$\theta_{JA}$	Thermal Resistance		70	$^{\circ}\text{C/W}$
$T_J$	Junction Temperature		150	$^{\circ}\text{C}$
$T_{STG}$	Storage Temperature	-55	150	$^{\circ}\text{C}$

### Notes:

- All input voltage ( $\overline{HINx}$  ,  $\overline{LINx}$  , CS, and EN) are referenced to  $V_{SS}$  and do not exceed maximum voltage rating.
- Mounted on 76.2 x 114.3 x 1.6mm PCB (FR-4 glass epoxy material). Refer to the following standards:  
*JESD51-2: Integral circuit's thermal test method environmental conditions, natural convection;*  
*JESD51-3: Low effective thermal conductivity test board for leaded surface-mount packages.*
- Do not exceed maximum power dissipation ( $P_D$ ) under any circumstances.

## Recommended Operating Conditions

The Recommended Operating Conditions table defines the conditions for actual device operation. Recommended operating conditions are specified to ensure optimal performance to the datasheet specifications. Fairchild does not recommend exceeding them or designing to Absolute Maximum Ratings.

Symbol	Parameter	Min.	Max.	Unit
$V_{B1,2,3}$	High-Side Floating Supply Voltage	$V_{S1,2,3}+10$	$V_{S1,2,3}+20$	V
$V_{S1,2,3}$	High-Side Floating Supply Offset Voltage	$6-V_{DD}$	600	V
$V_{DD}$	Low-Side and Logic Fixed Supply Voltage	10	20	V
$V_{HO1,2,3}$	High-Side Output Voltage	$V_{S1,2,3}$	$V_{B1,2,3}$	V
$V_{LO1,2,3}$	Low-Side Output Voltage	COM	$V_{DD}$	V
$V_{FO}$	Fault Output Voltage ( $\overline{FO}$ )	$V_{SS}$	$V_{DD}$	V
$V_{CS}$	Current-Sense Pin Input Voltage	$V_{SS}$	$V_{SS} + 5$	V
$V_{IN}$	Logic Input Voltage ( $\overline{HIN1,2,3}$ and $\overline{LIN1,2,3}$ )	$V_{SS}$	$V_{SS} + 5$	V
$V_{SS}$	Logic Ground	-5	5	V
$T_A$	Ambient Temperature	-40	+125	$^{\circ}\text{C}$

## Electrical Characteristics

$V_{BIAS}$  ( $V_{DD}$ ,  $V_{BS1,2,3}$ ) = 15.0 V and  $T_A$  = 25°C unless otherwise specified. The  $V_{IN}$  and  $I_{IN}$  parameters are referenced to  $V_{SS}$  and are applicable to all six channels. The  $V_O$  and  $I_O$  parameters are referenced to  $V_{S1,2,3}$  and COM and are applicable to the respective output leads: HO1,2,3 and LO1,2,3. The  $V_{DDUV}$  parameters are referenced to  $V_{SS}$ . The  $V_{BSUV}$  parameters are referenced to  $V_{S1,2,3}$ .

Symbol	Parameter	Condition	Min.	Typ.	Max.	Unit
<b>Low-Side Power Supply Section</b>						
$I_{QDD}$	Quiescent $V_{DD}$ Supply Current	$V_{LIN1,2,3}=5$ V or open, EN=0 V		250	400	$\mu$ A
$I_{PDD}$	Operating $V_{DD}$ Supply Current	$f_{LIN1,2,3}=20$ kHz, rms Value		550	750	$\mu$ A
$V_{DDUV+}$	$V_{DD}$ Supply Under-Voltage Positive-Going Threshold	$V_{DD}=\text{Sweep}$	7.5	8.5	9.3	V
$V_{DDUV-}$	$V_{DD}$ Supply Under-Voltage Negative-Going Threshold	$V_{DD}=\text{Sweep}$	7.0	8.0	8.7	V
$V_{DDHYS}$	$V_{DD}$ Supply Under-Voltage Lockout Hysteresis	$V_{DD}=\text{Sweep}$		0.5		V
<b>Bootstrapped Power Supply Section</b>						
$V_{BSUV+}$	$V_{BS}$ Supply Under-Voltage Positive-Going Threshold	$V_{BS1,2,3}=\text{Sweep}$	7.5	8.5	9.3	V
$V_{BSUV-}$	$V_{BS}$ Supply Under-Voltage Negative-Going Threshold	$V_{BS1,2,3}=\text{Sweep}$	7.0	8.0	8.7	V
$V_{BSHYS}$	$V_{BS}$ Supply Under-Voltage Lockout Hysteresis	$V_{BS1,2,3}=\text{Sweep}$		0.5		V
$I_{LK}$	Offset Supply Leakage Current	$V_{B1,2,3}=V_{S1,2,3}=600$ V			10	$\mu$ A
$I_{QBS}$	Quiescent $V_{BS}$ Supply Current	$V_{HIN1,2,3}=0$ V or 5 V, EN=0 V	10	50	80	$\mu$ A
$I_{PBS}$	Operating $V_{BS}$ Supply Current	$f_{HIN1,2,3}=20$ kHz, rms Value	200	320	480	$\mu$ A
<b>Gate Driver Output Section</b>						
$V_{OH}$	High-Level Output voltage, $V_{BIAS}-V_O$	$I_O=0$ mA (No Load)			100	mV
$V_{OL}$	Low-Level Output voltage, $V_O$	$I_O=0$ mA (No Load)			100	mV
$I_{O+}$	Output HIGH Short-Circuit Pulse Current <sup>(5)</sup>	$V_O=0$ V, $V_{IN}=0$ V with $PW \leq 10$ $\mu$ s	250	350		mA
$I_{O-}$	Output LOW Short-Circuit Pulsed Current <sup>(5)</sup>	$V_O=15$ V, $V_{IN}=5$ V with $PW \leq 10$ $\mu$ s	500	650		mA
$V_S$	Allowable Negative $V_S$ Pin Voltage for HIN Signal Propagation to HO			-9.8	-9.0	V
<b>Logic Input Section</b>						
$V_{IH}$	Logic "0" Input Voltage $\overline{HIN1,2,3}$ , $\overline{LIN1,2,3}$		2.5			V
$V_{IL}$	Logic "1" Input Voltage $HIN1,2,3$ , $LIN1,2,3$				0.8	V
$I_{IN+}$	Logic Input Bias Current (HO=LO=HIGH)	$V_{IN}=0$ V	77	100	143	$\mu$ A
$I_{IN-}$	Logic Input Bias Current (HO=LO=LOW)	$V_{IN}=5$ V		8.5	25	$\mu$ A
$R_{IN}$	Logic Input Pull-Up Resistance		35	50	65	K $\Omega$
<b>Enable Control Section (EN)</b>						
$V_{EN+}$	Enable Positive-Going Threshold Voltage		2.5			V
$V_{EN-}$	Enable Negative-Going Threshold Voltage				0.8	V
$I_{EN+}$	Logic Enable "1" Input Bias Current	$V_{EN}=5$ V (Pull-Down=150 K $\Omega$ )	15	33	50	$\mu$ A
$I_{EN-}$	Logic Enable "0" Input Bias Current	$V_{EN}=0$ V			2	$\mu$ A
$R_{EN}$	Logic Input Pull-Down Resistance		100	150	333	K $\Omega$

## Electrical Characteristics

$V_{BIAS}$  ( $V_{DD}$ ,  $V_{BS1,2,3}$ ) = 15.0 V and  $T_A$  = 25°C unless otherwise specified. The  $V_{IN}$  and  $I_{IN}$  parameters are referenced to  $V_{SS}$  and are applicable to all six channels. The  $V_O$  and  $I_O$  parameters are referenced to  $V_{S1,2,3}$  and COM and are applicable to the respective output leads: HO1,2,3 and LO1,2,3. The  $V_{DDUV}$  parameters are referenced to  $V_{SS}$ . The  $V_{BSUV}$  parameters are referenced to  $V_{S1,2,3}$ .

Symbol	Parameter	Condition	Min.	Typ.	Max.	Unit
<b>Over-Current Protection Section</b>						
$V_{CSTH+}$	Over-Current Detect Positive Threshold		450	500	550	mV
$V_{CSTH-}$	Over-Current Detect Negative Threshold			440		mV
$V_{CSHYS}$	Over-Current Detect Hysteresis			60		mV
$I_{CSIN}$	Short-Circuit Input Current	$V_{CSIN}=1$ V	5	10	15	$\mu$ A
$I_{SOFT}$	Soft Turn-Off Sink Current		25	40	55	mA
<b>Fault Output Section</b>						
$V_{RCINTH+}$	RCIN Positive-Going Threshold Voltage		2.7	3.3	3.9	V
$V_{RCINTH-}$	RCIN Negative-Going Threshold Voltage <sup>(5)</sup>			2.6		V
$V_{RCINHYS}$	RCIN Hysteresis Voltage <sup>(5)</sup>			0.7		V
$I_{RCIN}$	RCIN Internal Current Source	$C_{RCIN}=2$ nF	3	5	7	$\mu$ A
$V_{FOL}$	Fault Output Low Level Voltage	$V_{CS}=1$ V, $I_{FO}=1.5$ mA		0.2	0.5	V
$R_{DSRCIN}$	RCIN On Resistance	$I_{RCIN}=1.5$ mA	50	75	100	$\Omega$
$R_{DSFO}$	Fault Output On Resistance	$I_{FO}=1.5$ mA	90	130	170	$\Omega$

### Note:

5. These parameters are guaranteed by design.

## Dynamic Electrical Characteristics

$T_A=25^\circ\text{C}$ ,  $V_{BIAS}$  ( $V_{DD}$ ,  $V_{BS1,2,3}$ ) =15.0 V,  $V_{S1,2,3} = \text{COM} = V_{SS}$ ,  $C_{RCIN}=2$  nF, and  $C_{Load} = 1000$  pF unless otherwise specified.

Symbol	Parameter	Conditions	Min.	Typ.	Max.	Unit
$t_{ON}$	Turn-On Propagation Delay	$V_{LIN1,2,3}=V_{HIN1,2,3}=0$ V, $V_{S1,2,3}=0$ V	350	500	650	ns
$t_{OFF}$	Turn-Off Propagation Delay	$V_{LIN1,2,3}=V_{HIN1,2,3}=5$ V, $V_{S1,2,3}=0$ V	350	500	650	ns
$t_R$	Turn-On Rise Time	$V_{LIN1,2,3}=V_{HIN1,2,3}=0$ V	20	50	100	ns
$t_F$	Turn-Off Fall Time	$V_{LIN1,2,3}=V_{HIN1,2,3}=5$ V	10	30	80	ns
$t_{EN}$	Enable LOW to Output Shutdown Delay		400	500	600	ns
$t_{CSBLT}$	CS Pin Leading-Edge Blanking Time		400	650	850	ns
$t_{CSFO}$	Time from CS Triggering to $\overline{FO}$	From $V_{CSC}=1$ V to $\overline{FO}$ Turn-Off		850	1300	ns
$t_{CSOFF}$	Time from CS Triggering to Low-Side Gate Outputs Turn-Off	From $V_{CSC}=1$ V to Starting Gate Turn-Off		850	1300	ns
$t_{FLTIN}$	Input Filtering Time <sup>(6)</sup> ( $\overline{HINx}$ , $\overline{LINx}$ , EN)		170	250	330	ns
$t_{FLTCLR}$	Fault-Clear Time	$C_{RCIN} = 2$ nF		1.30	2.35	ms
DT	Dead Time		230	320	400	ns
MDT	Dead-Time Matching (All Six Channels)				50	ns
MT	Delay Matching (All Six Channels)				50	ns
PM	Output Pulse-Width Matching <sup>(7)</sup>	$PW_{IN} > 1$ $\mu$ s		50	100	ns

### Notes:

6. The minimum width of the input pulse should exceed 500 ns to ensure the filtering time of the input filter is exceeded.  
 7. PM is defined as  $PW_{IN}-PW_{OUT}$ .

## Typical Characteristics

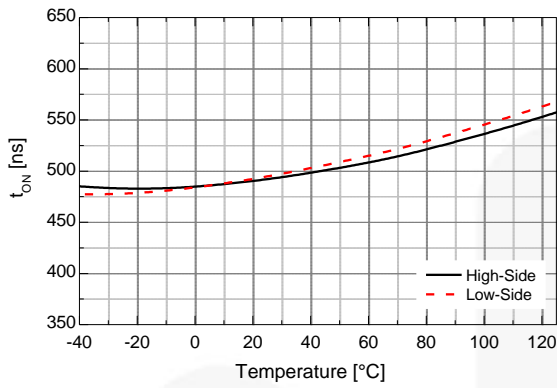

**Figure 4. Turn-On Propagation Delay vs. Temperature**

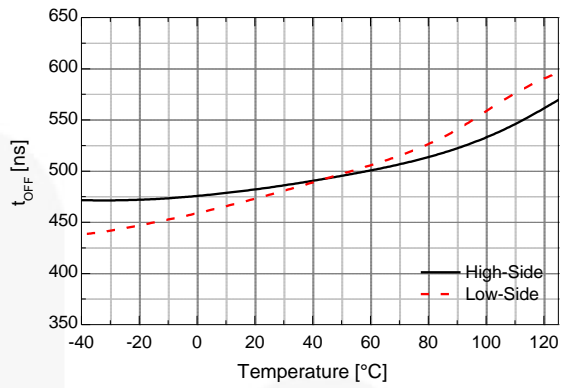

**Figure 5. Turn-Off Propagation Delay vs. Temperature**

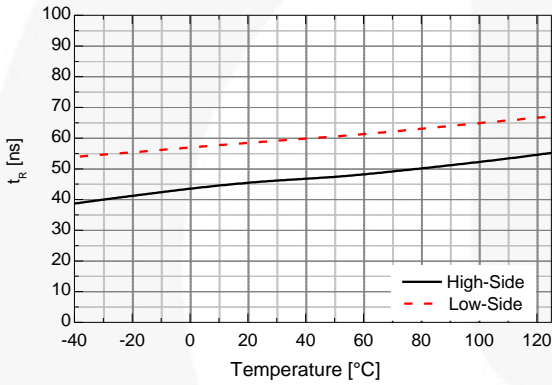

**Figure 6. Turn-On Rise Time vs. Temperature**

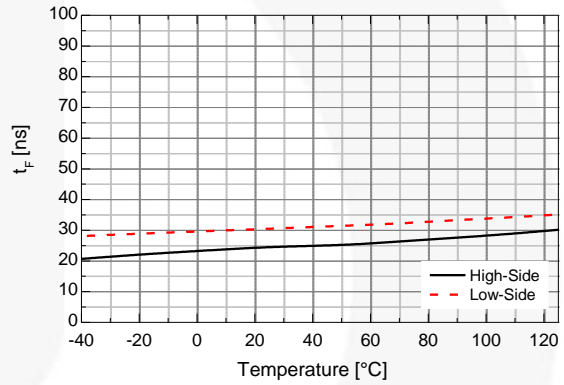

**Figure 7. Turn-Off Fall Time vs. Temperature**

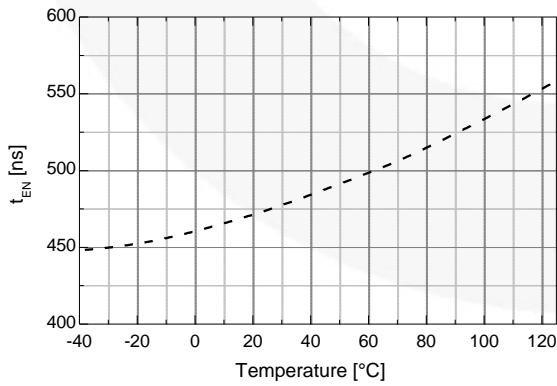

**Figure 8. Enable LOW to Output Shutdown Delay vs. Temperature**

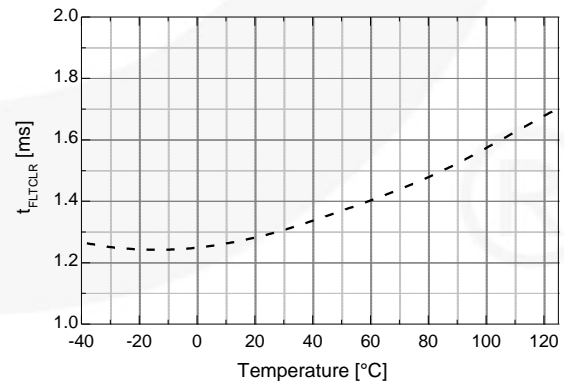

**Figure 9. Fault-Clear Time vs. Temperature**



Typical Characteristics (Continued)

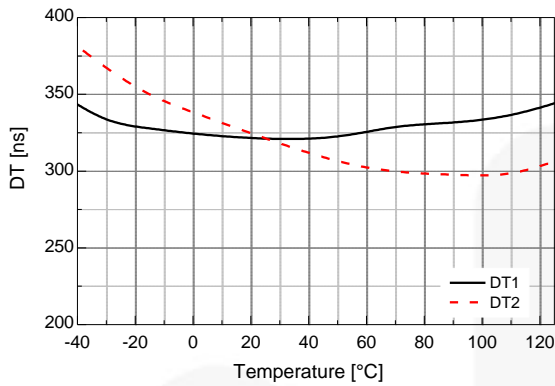

Figure 10. Dead Time vs. Temperature

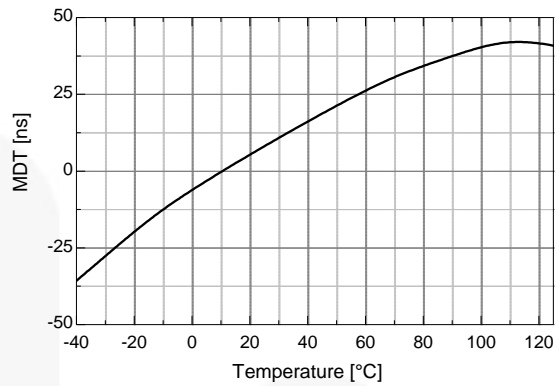

Figure 11. Dead-Time Matching vs. Temperature

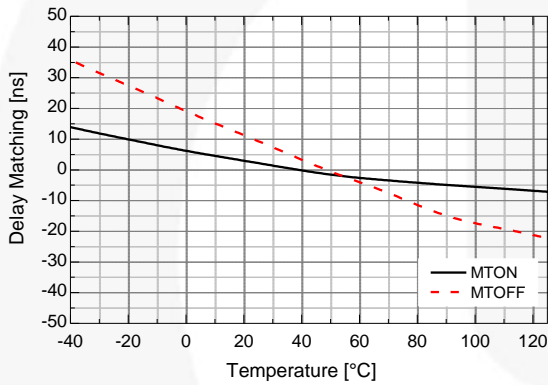

Figure 12. Delay Matching vs. Temperature

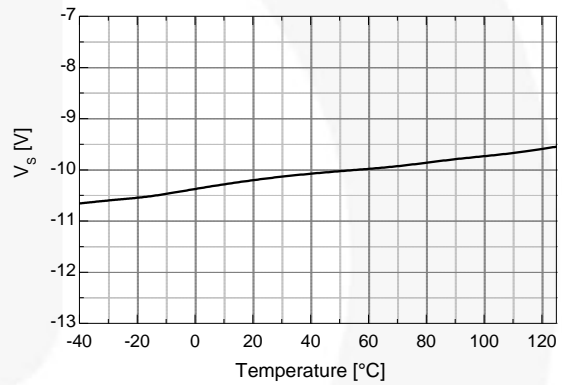

Figure 13. Allowable Negative  $V_S$  Voltage vs. Temperature

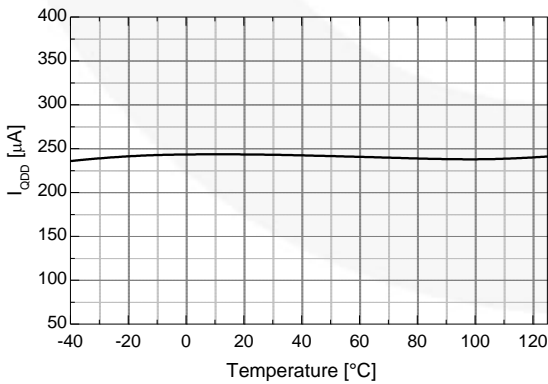

Figure 14. Quiescent  $V_{DD}$  Supply Current vs. Temperature

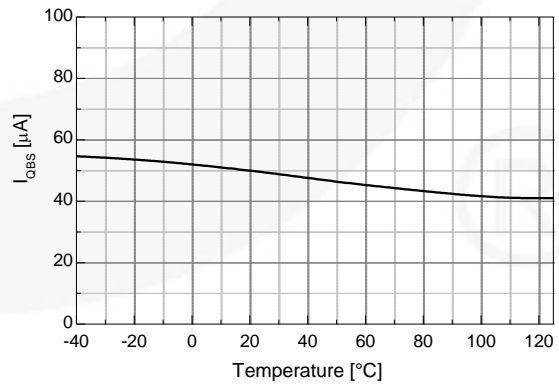

Figure 15. Quiescent  $V_{BS}$  Supply Current vs. Temperature

Typical Characteristics (Continued)

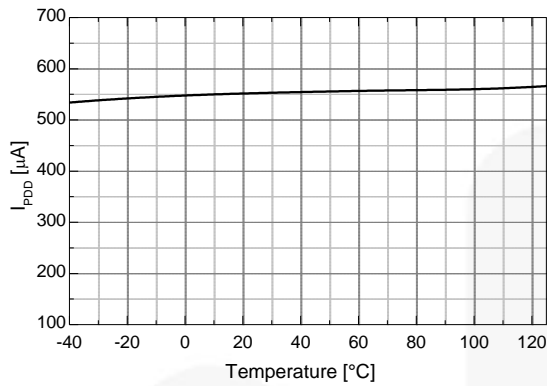

Figure 16. Operating  $V_{DD}$  Supply Current vs. Temperature

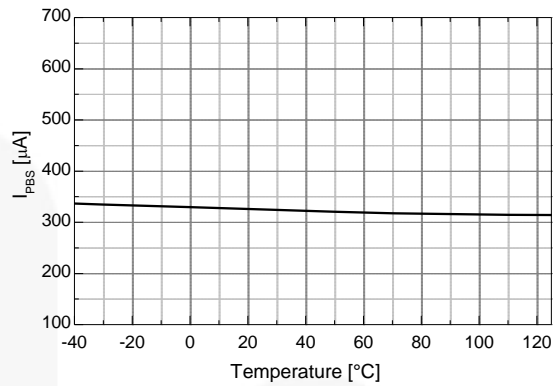

Figure 17. Operating  $V_{BS}$  Supply Current vs. Temperature

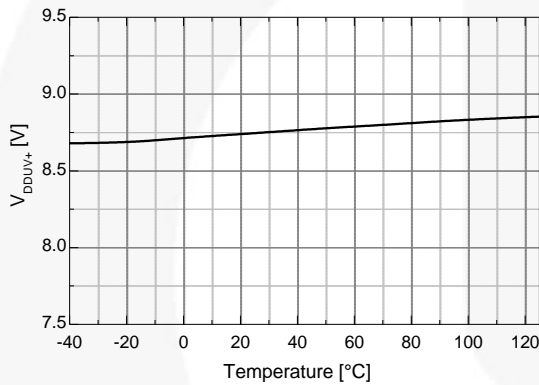

Figure 18.  $V_{DD}$  UVLO+ vs. Temperature

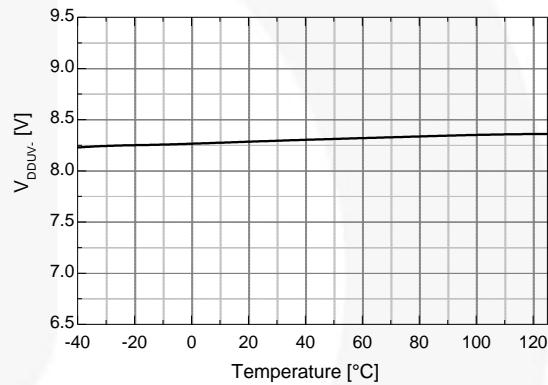

Figure 19.  $V_{DD}$  UVLO- vs. Temperature

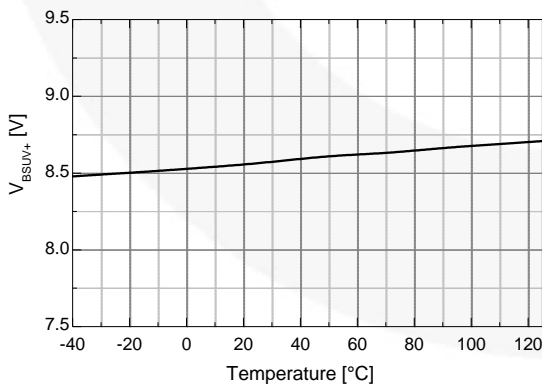

Figure 20.  $V_{BS}$  UVLO+ vs. Temperature

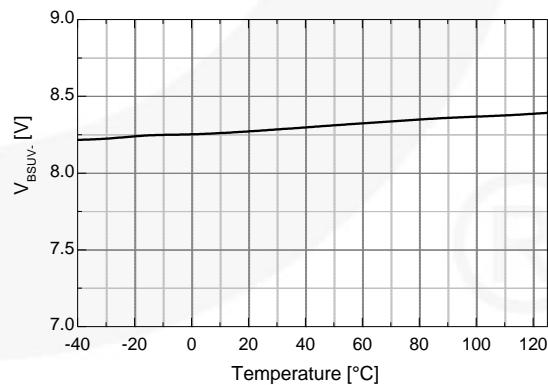

Figure 21.  $V_{BS}$  UVLO- vs. Temperature

Typical Characteristics (Continued)

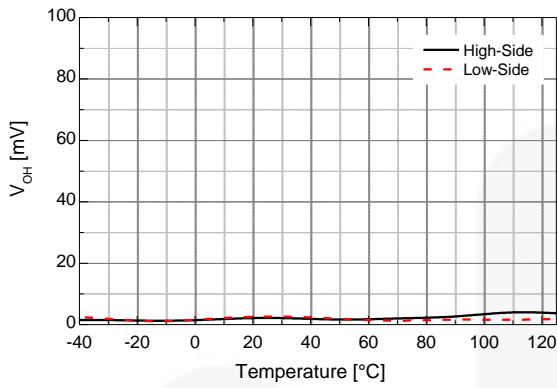

Figure 22. High-Level Output Voltage vs. Temperature

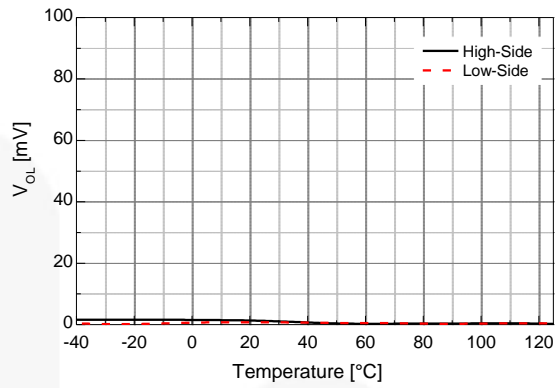

Figure 23. Low-Level Output Voltage vs. Temperature

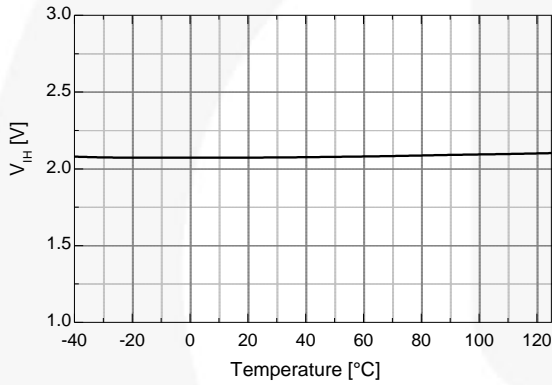

Figure 24. Logic HIGH Input Voltage vs. Temperature

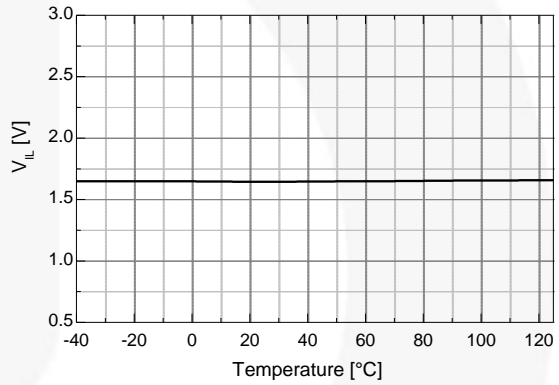

Figure 25. Logic LOW Input Voltage vs. Temperature

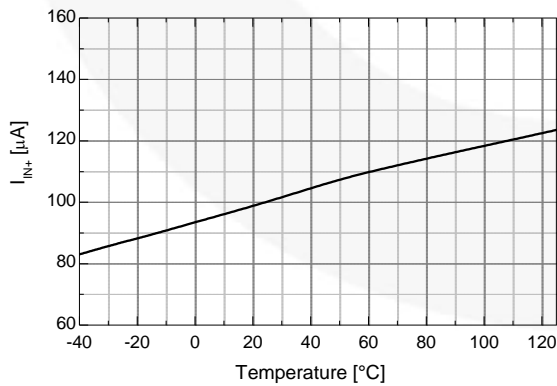

Figure 26. Logic Input HIGH Bias Current vs. Temperature

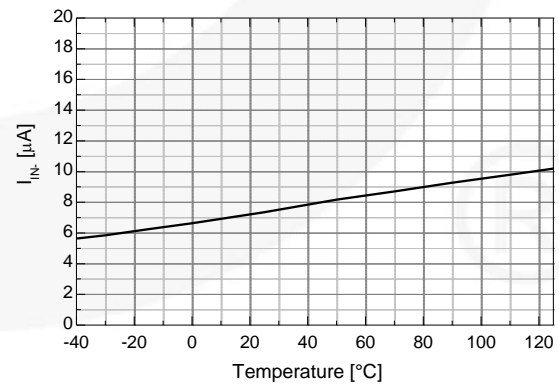

Figure 27. Logic Input LOW Bias Current vs. Temperature

Typical Characteristics (Continued)

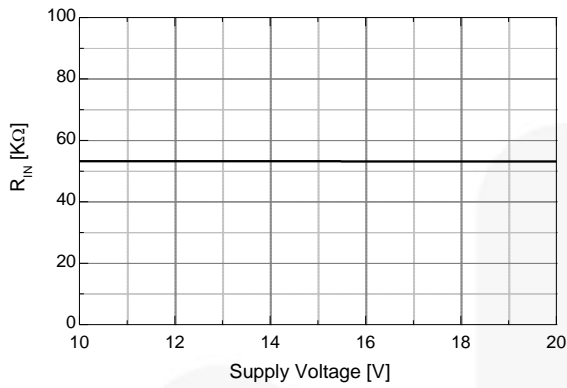

Figure 28. Input Pull-Down Resistance vs. Supply Voltage

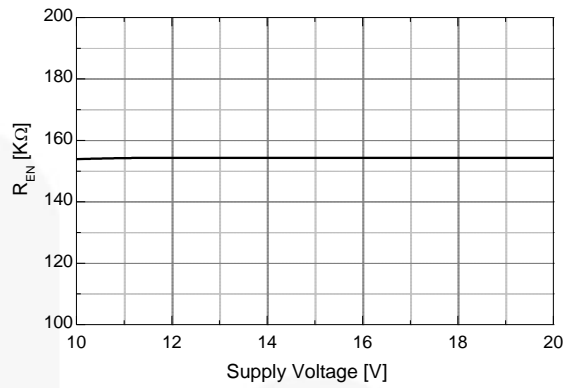

Figure 29. Enable Pin Pull-Down Resistance vs. Supply Voltage

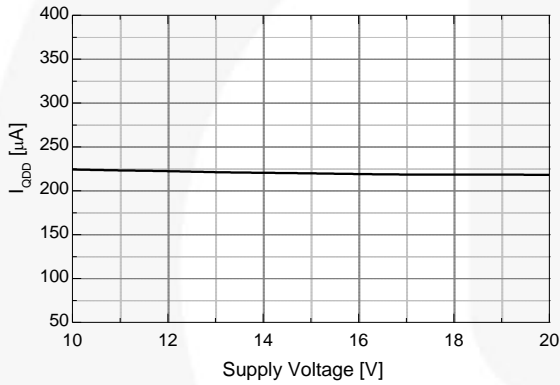

Figure 30. Quiescent  $V_{DD}$  Supply Current vs. Supply Voltage

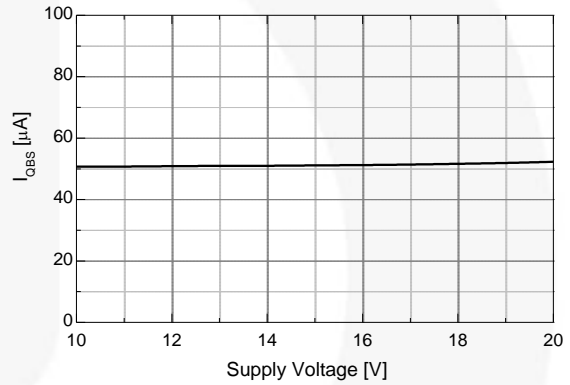

Figure 31. Quiescent  $V_{BS}$  Supply Current vs. Supply Voltage

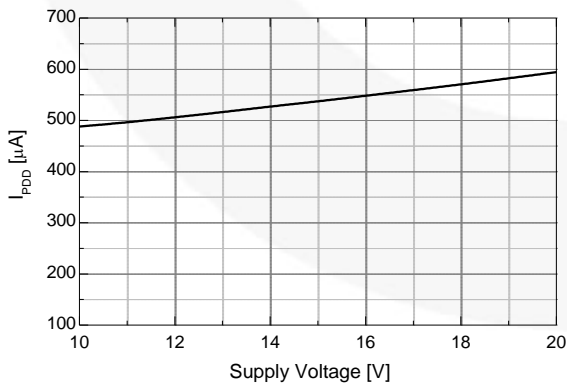

Figure 32. Operating  $V_{DD}$  Supply Current vs. Supply Voltage

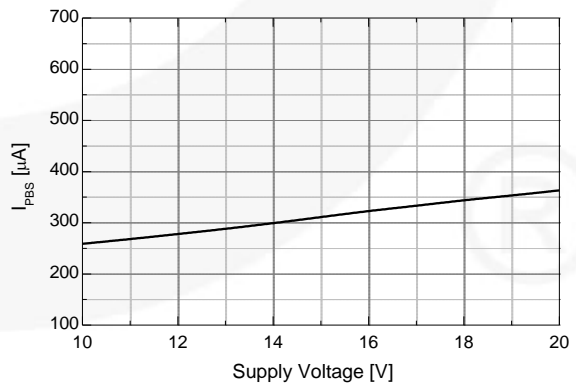

Figure 33. Operating  $V_{BS}$  Supply Current vs. Supply Voltage

### Switching Time Definitions

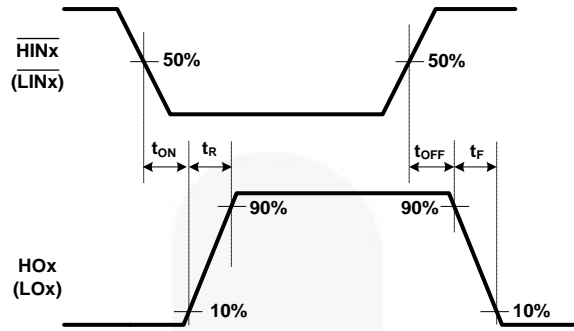

Figure 34. Switching Time Waveform Definitions

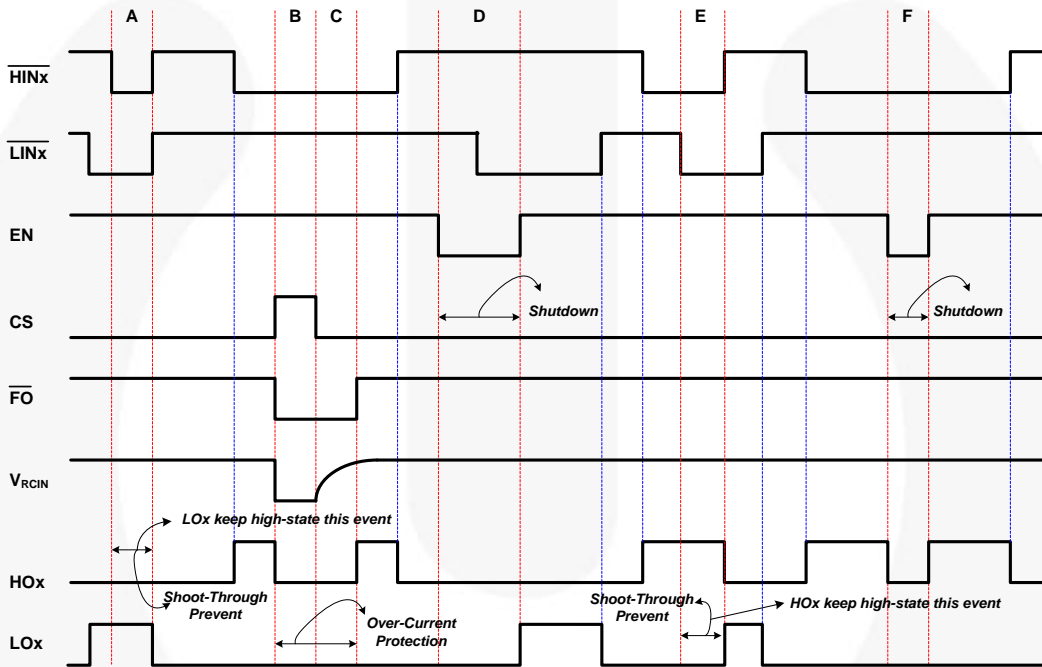

Figure 35. Input / Output Timing Diagram

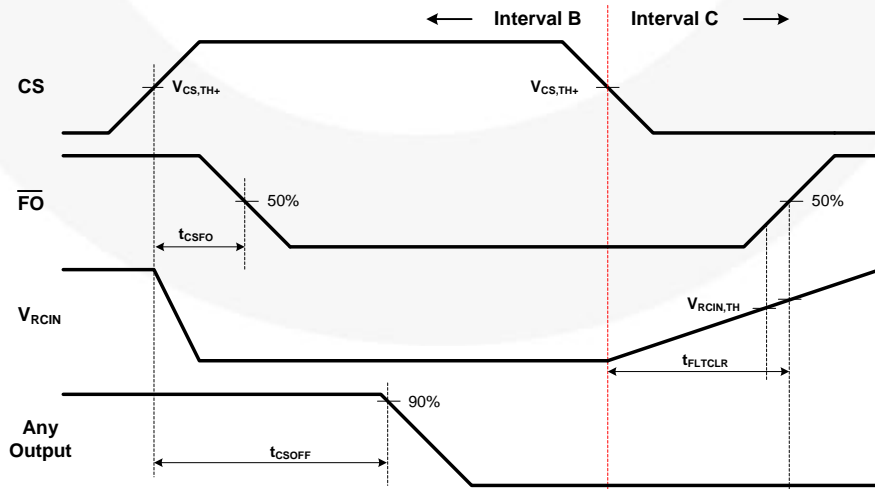

Figure 36. Detailed View of B and C Intervals During Over-Current Protection

## Applications Information

### 1. Dead Time

Dead time is automatically inserted whenever the dead time of the external two input signals (between  $\overline{\text{HINx}}$  and  $\overline{\text{LINx}}$  signals) is shorter than internal fixed dead times ( $\text{DT1}$  and  $\text{DT2}$ ). Otherwise, external dead times larger than internal dead times are not modified by the gate driver and internal dead-time waveform definition is shown in Figure 37.

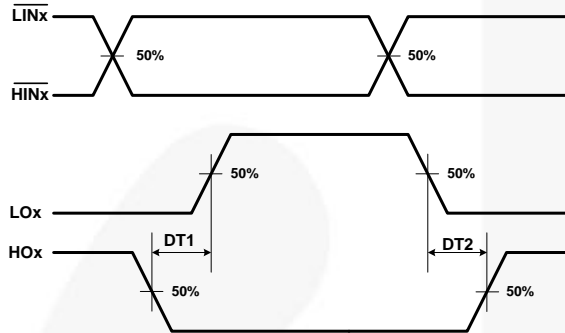

Figure 37. Internal Dead-Time Definitions

### 2. Protection Function

#### 2.1 Fault Out ( $\overline{\text{FO}}$ ) and Under-Voltage Lockout

The high- and low-side drivers include Under-Voltage Lockout (UVLO) protection circuitry that monitors the supply voltage for  $V_{\text{DD}}$  and  $V_{\text{BS}}$  independently. It can be designed to prevent malfunction when  $V_{\text{DD}}$  and  $V_{\text{BS}}$  are lower than the specified threshold voltage. The UVLO hysteresis prevents chattering during power-supply transitions. Moreover, the fault signal (power supply voltage  $\overline{\text{FO}}$ ) goes to LOW state to operate reliably during power-on events when the power supply ( $V_{\text{DD}}$ ) is below the under-voltage lockout high threshold voltage for the circuit (during  $t_1 \sim t_2$ ). The UVLO circuit is not otherwise activated; shown Figure 38. If  $V_{\text{DD}}$  is lower than 3.5 V, the fault signal cannot be driven to LOW state because  $V_{\text{DD}}$  is not enough to drive internal circuit.

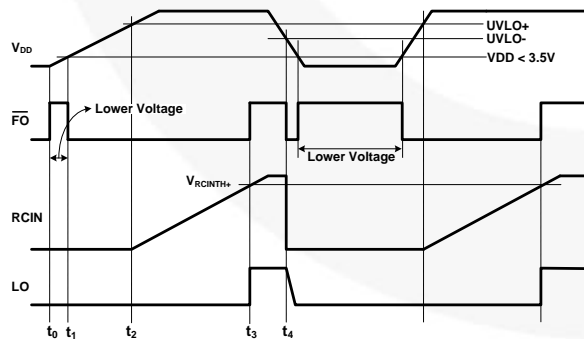

Figure 38. Waveforms for Under-Voltage Lockout

### 2.2 Shoot-Through Protection

The shoot-through protection circuitry prevents both high- and low-side switches from conducting at the same time, as shown Figure 39.

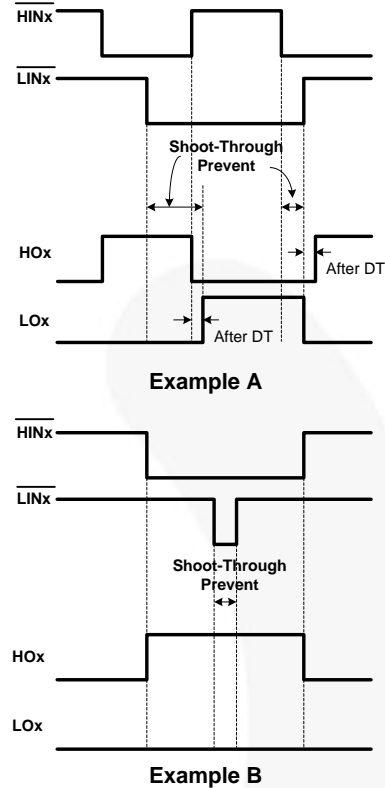
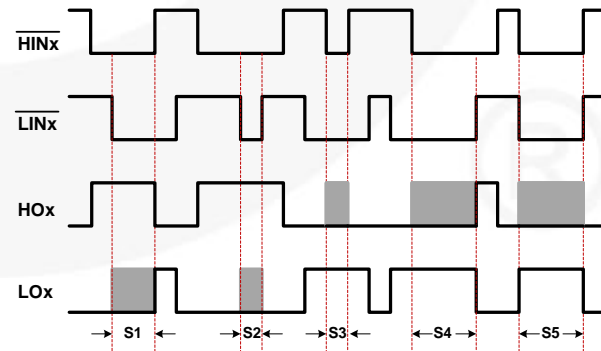

Figure 39. Shoot-Through Protection

An interlock function is a device used to prevent both high- and low-side switches from conducting at the same time as shown Figure 40. In most applications an interlock is used to help prevent a device from harming its operator or damaging itself by when two input signals of a same leg are activated simultaneously, only one output is activated.



- S1 : High-side first → First input output mode
- S2 : Low-side noise → No LOx output mode
- S3 : High-side noise → No HOx output mode
- S4 : Low-side first → First input output mode
- S5 : In-phase mode → No HOx output

Figure 40. Interlock Function

### 2.3 Enable Input

When the EN pin is in HIGH state, the gate driver operates normally. When a condition occurs that should shut down the gate driver, the EN pin should be LOW. The enable circuitry has an input filter; the minimum input duration is specified by  $t_{FLTIN}$  (typically 250 ns).

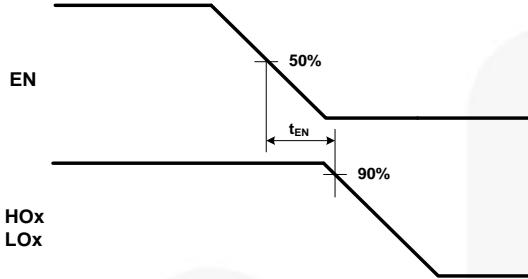

**Figure 41. Output Enable Timing Waveform**

### 2.4 Fault-Out (FO) and Over-Current Protection

FAN73893 provides an integrated fault output (FO) and an adjustable fault-clear timer ( $t_{FLTCLR}$ ). There are two situations that cause the gate driver to report a fault via the FO pin. The first is an under-voltage condition of low-side gate driver supply voltage ( $V_{DD}$ ) and the second is when the current-sense pin (CS) recognizes a fault. If a fault condition occurs, the FO pin is internally pulled to COM, the fault-clear timer is activated, and all outputs (HO1, 2, 3 and LO1, 2, 3) of the gate driver are turned off. The fault output stays LOW until the fault condition has been removed and the fault-clear timer expires. Once the fault-clear timer expires, the voltage on the FO pin returns to pull-up voltage.

The fault-clear time ( $t_{FLTCLR}$ ) is determined by an internal current source ( $I_{RCIN}=5 \mu A$ ) and an external  $C_{RCIN}$  at the RCIN pin, as shown as:

$$t_{FLTCLR} = \frac{C_{RCIN} \times V_{RCIN,TH}}{I_{RCIN}} \quad [s] \quad (1)$$

The  $R_{DSRCIN}$  of the MOSFET is a characteristic discharge curve with respect to the external capacitor  $C_{RCIN}$ . The time constant is defined by the external capacitor  $C_{RCIN}$  and the  $R_{DSRCIN}$  of the MOSFET.

The output of current-sense comparator (CS\_COMP) passes a noise filter, which inhibits an over-current shutdown caused by parasitic voltage spikes of  $V_{CS}$ .

This corresponds to a voltage level at the comparator of  $V_{CSTH+} - V_{CSHYS} = 500 \text{ mV} - 60 \text{ mV} = 440 \text{ mV}$ , where  $V_{CSHYS}=60 \text{ mV}$  is the hysteresis of the current comparator (CS\_COMP), as shown in Figure 42.

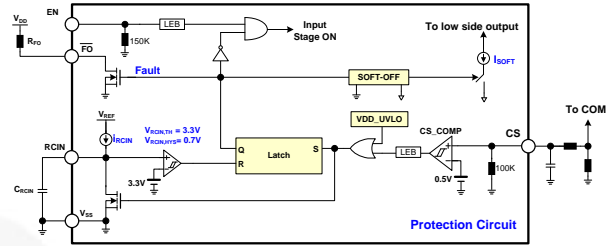

**Figure 42. Over-Current Protection**

Figure 43 shows the waveform definitions of RCIN, FO, and the low-side driver; which uses a soft turn-off method when an under-voltage condition of the low-side gate driver supply voltage ( $V_{DD}$ ) or the current-sense pin (CS) recognizes a fault. If a fault condition occurs, the FO Pin is internally pulled to COM and all outputs (HO1,2,3 and LO1,2,3) of the gate driver are turned off. Low-side outputs decline linearly by the internal sink current source ( $I_{SOFT}=40 \text{ mA}$ ) for soft turn-off, as shown in Figure 43.

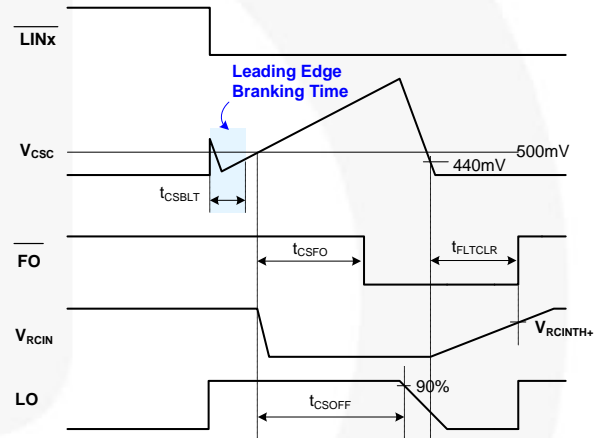

**Figure 43. RCIN and Fault-Clear Waveform Definition**

## 3. Noise Filter

### 3.1 Input Noise Filter

Figure 44 shows the input noise filter method, which has symmetry duration between the input signal ( $t_{INPUT}$ ) and the output signal ( $t_{OUTPUT}$ ) and helps to reject noise spikes and short pulses. This input filter is applied to the HINx, LINx, and EN inputs. The upper pair of waveforms (Example A) shows an input signal duration ( $t_{INPUT}$ ) much longer than input filter time ( $t_{FLTIN}$ ); it is approximately the same duration between the input signal time ( $t_{INPUT}$ ) and the output signal time ( $t_{OUTPUT}$ ). The lower pair of waveforms (Example B) shows an input signal time ( $t_{INPUT}$ ) slightly longer than input filter time ( $t_{FLTIN}$ ); it is approximately the same duration between input signal time ( $t_{INPUT}$ ) and the output signal time ( $t_{OUTPUT}$ ).

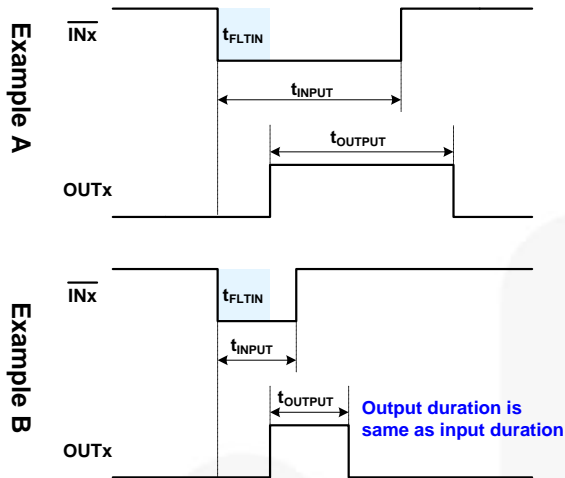

Figure 44. Input Noise Filter Definition

**3.2. Short-Pulsed Input Noise Rejection Method**

The input filter circuitry provides protection against short-pulsed input signals (  $HINx$  ,  $LINx$  , and  $EN$  ) on the input signal lines by applied noise signal.

If the input signal duration is less than input filter time ( $t_{FLTIN}$ ), the output does not change states.

Example A and B of the Figure 45 show the input and output waveforms with short-pulsed noise spikes with a duration less than input filter time; the output does not change states.

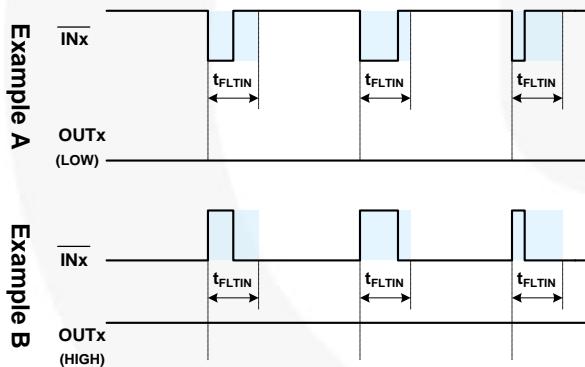

Figure 45. Noise Rejecting Input Filter Definition

Figure 46 shows the characteristics of the input filters while receiving narrow ON and OFF pulses. If input signal pulse duration,  $PW_{IN}$ , is less than input filter time,  $t_{FLTIN}$ ; the output pulse,  $PW_{OUT}$ , is zero. The input signal is rejected by input filter. Once the input signal pulse duration,  $PW_{IN}$ , exceeds input filter time,  $t_{FLTIN}$ , the output pulse durations,  $PW_{OUT}$ , matches the input pulse durations,  $PW_{IN}$ . FAN73893 input filter time,  $t_{FLTIN}$ , is about 250 ns for the high- and low-side outputs.

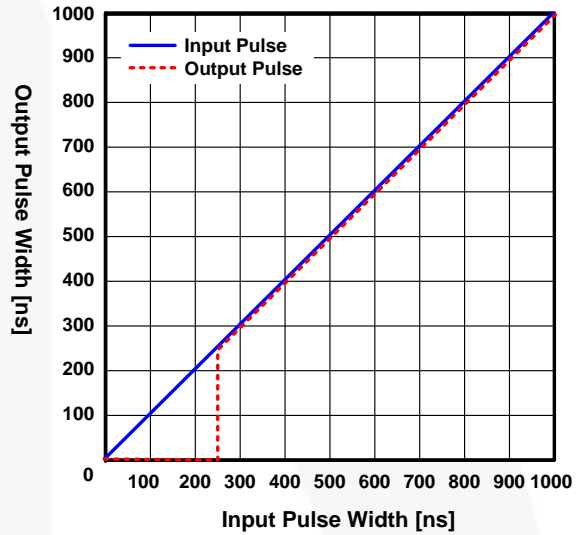

Figure 46. Input Filter Characteristic of Narrow ON





ON Semiconductor and  are trademarks of Semiconductor Components Industries, LLC dba ON Semiconductor or its subsidiaries in the United States and/or other countries. ON Semiconductor owns the rights to a number of patents, trademarks, copyrights, trade secrets, and other intellectual property. A listing of ON Semiconductor's product/patent coverage may be accessed at [www.onsemi.com/site/pdf/Patent-Marking.pdf](http://www.onsemi.com/site/pdf/Patent-Marking.pdf). ON Semiconductor reserves the right to make changes without further notice to any products herein. ON Semiconductor makes no warranty, representation or guarantee regarding the suitability of its products for any particular purpose, nor does ON Semiconductor assume any liability arising out of the application or use of any product or circuit, and specifically disclaims any and all liability, including without limitation special, consequential or incidental damages. Buyer is responsible for its products and applications using ON Semiconductor products, including compliance with all laws, regulations and safety requirements or standards, regardless of any support or applications information provided by ON Semiconductor. "Typical" parameters which may be provided in ON Semiconductor data sheets and/or specifications can and do vary in different applications and actual performance may vary over time. All operating parameters, including "Typicals" must be validated for each customer application by customer's technical experts. ON Semiconductor does not convey any license under its patent rights nor the rights of others. ON Semiconductor products are not designed, intended, or authorized for use as a critical component in life support systems or any FDA Class 3 medical devices or medical devices with a same or similar classification in a foreign jurisdiction or any devices intended for implantation in the human body. Should Buyer purchase or use ON Semiconductor products for any such unintended or unauthorized application, Buyer shall indemnify and hold ON Semiconductor and its officers, employees, subsidiaries, affiliates, and distributors harmless against all claims, costs, damages, and expenses, and reasonable attorney fees arising out of, directly or indirectly, any claim of personal injury or death associated with such unintended or unauthorized use, even if such claim alleges that ON Semiconductor was negligent regarding the design or manufacture of the part. ON Semiconductor is an Equal Opportunity/Affirmative Action Employer. This literature is subject to all applicable copyright laws and is not for resale in any manner.

## PUBLICATION ORDERING INFORMATION

### LITERATURE FULFILLMENT:

Literature Distribution Center for ON Semiconductor  
19521 E. 32nd Pkwy, Aurora, Colorado 80011 USA  
**Phone:** 303-675-2175 or 800-344-3860 Toll Free USA/Canada  
**Fax:** 303-675-2176 or 800-344-3867 Toll Free USA/Canada  
**Email:** [orderlit@onsemi.com](mailto:orderlit@onsemi.com)

**N. American Technical Support:** 800-282-9855 Toll Free  
USA/Canada  
**Europe, Middle East and Africa Technical Support:**  
Phone: 421 33 790 2910  
**Japan Customer Focus Center**  
Phone: 81-3-5817-1050

**ON Semiconductor Website:** [www.onsemi.com](http://www.onsemi.com)  
**Order Literature:** <http://www.onsemi.com/orderlit>  
For additional information, please contact your local  
Sales Representative

# Mouser Electronics

Authorized Distributor

Click to View Pricing, Inventory, Delivery & Lifecycle Information:

[ON Semiconductor:](#)

[FAN73893MX](#)



## Стандарт Электрон Связь

Мы молодая и активно развивающаяся компания в области поставок электронных компонентов. Мы поставляем электронные компоненты отечественного и импортного производства напрямую от производителей и с крупнейших складов мира.

Благодаря сотрудничеству с мировыми поставщиками мы осуществляем комплексные и плановые поставки широчайшего спектра электронных компонентов.

Собственная эффективная логистика и склад в обеспечивает надежную поставку продукции в точно указанные сроки по всей России.

Мы осуществляем техническую поддержку нашим клиентам и предпродажную проверку качества продукции. На все поставляемые продукты мы предоставляем гарантию .

Осуществляем поставки продукции под контролем ВП МО РФ на предприятия военно-промышленного комплекса России , а также работаем в рамках 275 ФЗ с открытием отдельных счетов в уполномоченном банке. Система менеджмента качества компании соответствует требованиям ГОСТ ISO 9001.

Минимальные сроки поставки, гибкие цены, неограниченный ассортимент и индивидуальный подход к клиентам являются основой для выстраивания долгосрочного и эффективного сотрудничества с предприятиями радиоэлектронной промышленности, предприятиями ВПК и научно-исследовательскими институтами России.

С нами вы становитесь еще успешнее!

### Наши контакты:

**Телефон:** +7 812 627 14 35

**Электронная почта:** [sales@st-electron.ru](mailto:sales@st-electron.ru)

**Адрес:** 198099, Санкт-Петербург,  
Промышленная ул, дом № 19, литера Н,  
помещение 100-Н Офис 331