

High Performance Schottky Rectifier, 2 x 15 A

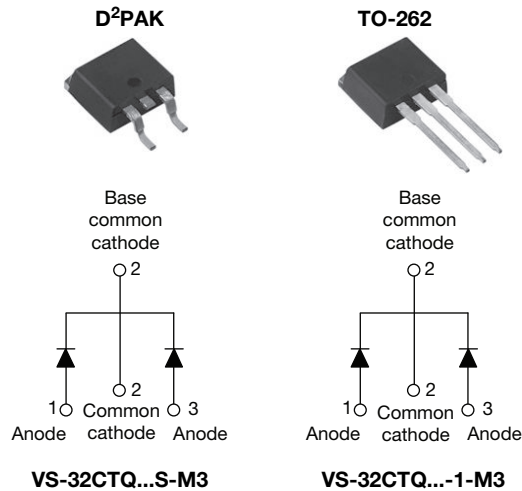

FEATURES

- 150 °C T_J operation
- Low forward voltage drop
- High frequency operation
- High purity, high temperature epoxy encapsulation for enhanced mechanical strength and moisture resistance
- Guard ring for enhanced ruggedness and long term reliability
- Meets MSL level 1, per J-STD-020, LF maximum peak of 260 °C
- AEC-Q101 qualified meets JESD 201 class 1A whisker test
- Material categorization: for definitions of compliance please see www.vishay.com/doc?99912



RoHS
COMPLIANT
HALOGEN
FREE

DESCRIPTION

The VS-32CTQ... Schottky rectifier series has been optimized for low reverse leakage at high temperature. The proprietary barrier technology allows for reliable operation up to 150 °C junction temperature. Typical applications are in switching power supplies, converters, freewheeling diodes, and reverse battery protection.

PRODUCT SUMMARY

| | |
|----------------------------------|---|
| I _{F(AV)} | 2 x 15 A |
| V _R | 25 V, 30 V |
| V _F at I _F | 0.40 V |
| I _{RM} max. | 97 mA at 125°C |
| T _J max. | 150 °C |
| E _{AS} | 13 mJ |
| Package | TO-263AB (D ² PAK), TO-262AA |
| Diode variation | Common cathode |

MAJOR RATINGS AND CHARACTERISTICS

| SYMBOL | CHARACTERISTICS | VALUES | UNITS |
|--------------------|--|-------------|-------|
| I _{F(AV)} | Rectangular waveform | 30 | A |
| V _R RRM | | 25/30 | V |
| I _{FSM} | t _p = 5 μs sine | 900 | A |
| V _F | 15 A _{pk} , T _J = 125 °C | 0.40 | V |
| T _J | Range | -55 to +150 | °C |

VOLTAGE RATINGS

| PARAMETER | SYMBOL | VS-32CTQ025SHM3 VS-32CTQ025-1HM3 | VS-32CTQ030SHM3 VS-32CTQ030-1HM3 | UNITS |
|--------------------------------------|------------------|-------------------------------------|-------------------------------------|-------|
| Maximum DC reverse voltage | V _R | 25 | 30 | V |
| Maximum working peak reverse voltage | V _{RWM} | | | |



| ABSOLUTE MAXIMUM RATINGS | | | | | |
|---|-------------|---|---|--------|-------|
| PARAMETER | SYMBOL | TEST CONDITIONS | | VALUES | UNITS |
| Maximum average forward current See fig. 5 | $I_{F(AV)}$ | 50 % duty cycle at $T_C = 115\text{ }^\circ\text{C}$, rectangular waveform | | 30 | A |
| Maximum peak one cycle non-repetitive surge current See fig. 7 | I_{FSM} | 5 μs sine or 3 μs rect. pulse | Following any rated load condition and with rated V_{RRM} applied | 900 | |
| | | 10 ms sine or 6 ms rect. pulse | | 250 | |
| Non-repetitive avalanche energy | E_{AS} | $T_J = 25\text{ }^\circ\text{C}$, $I_{AS} = 1.20\text{ A}$, $L = 11.10\text{ mH}$ | | 13 | mJ |
| Repetitive avalanche current | I_{AR} | Current decaying linearly to zero in 1 μs Frequency limited by T_J maximum $V_A = 1.5 \times V_R$ typical | | 3 | A |

| ELECTRICAL SPECIFICATIONS | | | | | |
|---|----------------|--|-----------------------------------|--------|------------------|
| PARAMETER | SYMBOL | TEST CONDITIONS | | VALUES | UNITS |
| Maximum forward voltage drop See fig. 1 | $V_{FM}^{(1)}$ | 15 A | $T_J = 25\text{ }^\circ\text{C}$ | 0.49 | V |
| | | 30 A | | 0.58 | |
| | | 15 A | $T_J = 125\text{ }^\circ\text{C}$ | 0.40 | |
| | | 30 A | | 0.53 | |
| Maximum reverse leakage current See fig. 2 | $I_{RM}^{(1)}$ | $T_J = 25\text{ }^\circ\text{C}$ | $V_R = \text{Rated } V_R$ | 1.75 | mA |
| | | $T_J = 125\text{ }^\circ\text{C}$ | | 97 | |
| Threshold voltage | $V_{F(TO)}$ | $T_J = T_J$ maximum | | 0.233 | V |
| Forward slope resistance | r_t | | | 9.09 | $\text{m}\Omega$ |
| Maximum junction capacitance per leg | C_T | $V_R = 5\text{ }V_{DC}$ (test signal range 100 kHz to 1 MHz), $25\text{ }^\circ\text{C}$ | | 1300 | pF |
| Typical series inductance per leg | L_S | Measured lead to lead 5 mm from package body | | 8.0 | nH |
| Maximum voltage rate of change | dV/dt | Rated V_R | | 10 000 | $V/\mu\text{s}$ |

Note

⁽¹⁾ Pulse width < 300 μs , duty cycle < 2 %

| THERMAL - MECHANICAL SPECIFICATIONS | | | | | |
|--|----------------|--------------------------------------|--|-------------|--|
| PARAMETER | SYMBOL | TEST CONDITIONS | | VALUES | UNITS |
| Maximum junction and storage temperature range | T_J, T_{Stg} | | | -55 to +150 | $^\circ\text{C}$ |
| Maximum thermal resistance, junction to case per leg | R_{thJC} | DC operation See fig. 4 | | 3.25 | $^\circ\text{C}/\text{W}$ |
| Typical thermal resistance, case to heatsink | R_{thCS} | Mounting surface, smooth and greased | | 0.50 | |
| Approximate weight | | | | 2 | g |
| | | | | 0.07 | oz. |
| Mounting torque | minimum | | | 6 (5) | $\text{kgf} \cdot \text{cm}$ ($\text{lbf} \cdot \text{in}$) |
| | maximum | | | 12 (10) | |
| Marking device | | Case style D ² PAK | | 32CTQ025SH | |
| | | | | 32CTQ030SH | |
| | | Case style TO-262 | | 32CTQ025-1H | |
| | | | | 32CTQ030-1H | |

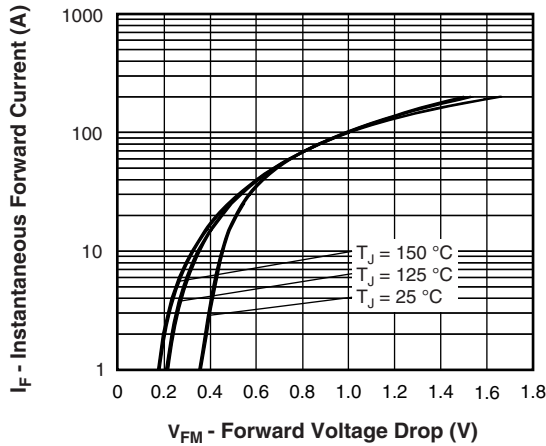

Fig. 1 - Maximum Forward Voltage Drop Characteristics

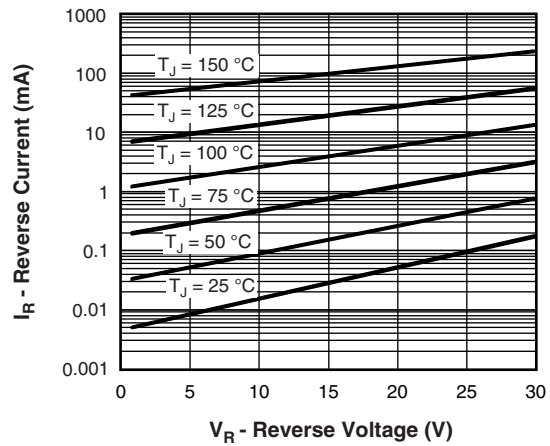

Fig. 2 - Typical Values of Reverse Current vs. Reverse Voltage

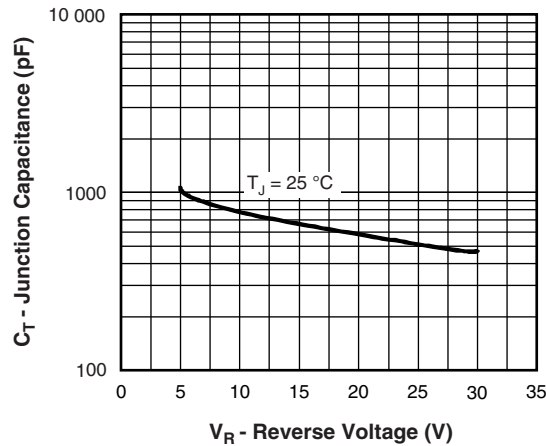

Fig. 3 - Typical Junction Capacitance vs. Reverse Voltage

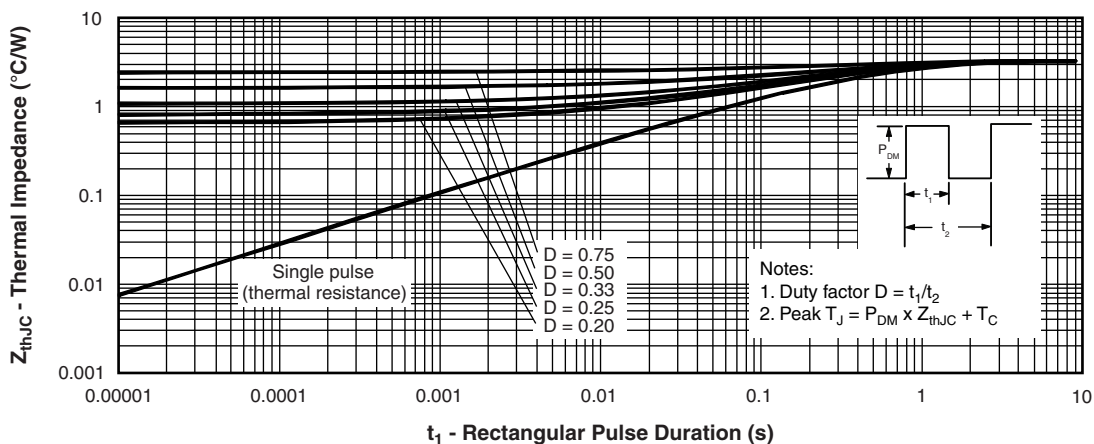

Fig. 4 - Maximum Thermal Impedance Z_{thJC} Characteristics

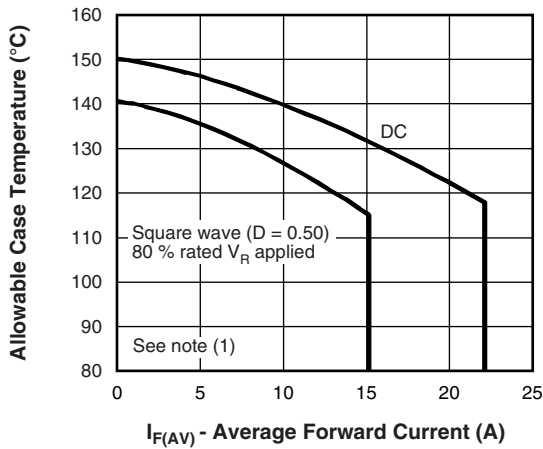

Fig. 5 - Maximum Allowable Case Temperature vs. Average Forward Current

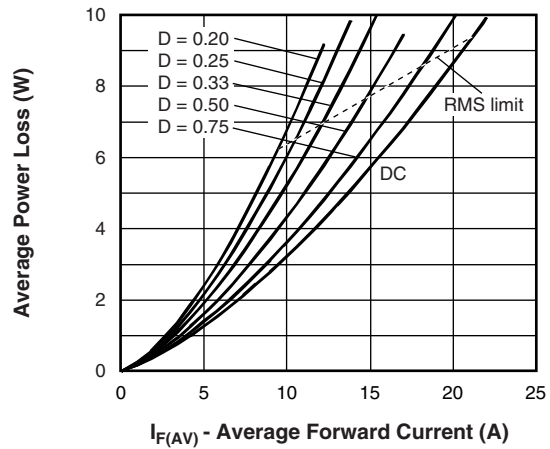

Fig. 6 - Forward Power Loss Characteristics

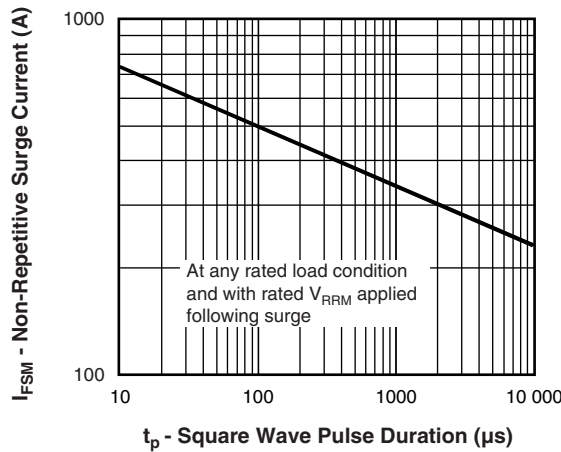

Fig. 7 - Maximum Non-Repetitive Surge Current

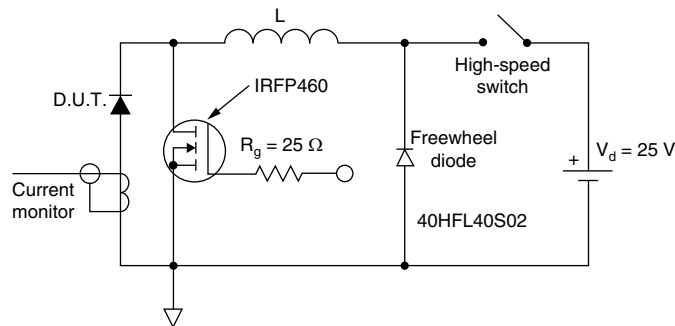

Fig. 8 - Unclamped Inductive Test Circuit

Note

- (1) Formula used: $T_C = T_J - (P_d + P_{dREV}) \times R_{thJC}$;
 P_d = Forward power loss = $I_{F(AV)} \times V_{FM}$ at $(I_{F(AV)}/D)$ (see fig. 6);
 P_{dREV} = Inverse power loss = $V_{R1} \times I_R (1 - D)$; I_R at $V_{R1} = 80\%$ rated V_R



ORDERING INFORMATION TABLE

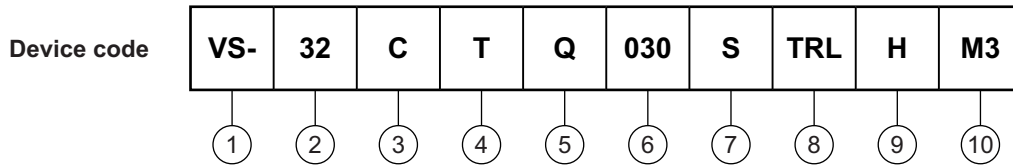

- 1** - Vishay Semiconductors product
- 2** - Current rating (30 A)
- 3** - Circuit configuration: C = common cathode
- 4** - T = TO-220
- 5** - Schottky "Q" series
- 6** - Voltage ratings ————

| |
|------------|
| 025 = 25 V |
| 030 = 30 V |
- 7** -
 - S = D²PAK
 - -1 = TO-262
- 8** -
 - None = tube
 - TRL = tape and reel (left oriented - for D²PAK only)
 - TRR = tape and reel (right oriented - for D²PAK only)
- 9** - H = AEC-Q101 qualified
- 10** - M3 = halogen-free, RoHS-compliant, and termination lead (Pb)-free

| ORDERING INFORMATION | | | |
|----------------------|------------------|------------------------|--------------------------|
| PREFERRED P/N | QUANTITY PER T/R | MINIMUM ORDER QUANTITY | PACKAGING DESCRIPTION |
| VS-32CTQ025SHM3 | 50 | 1000 | Antistatic plastic tubes |
| VS-32CTQ025STRRH3 | 800 | 800 | 13" diameter reel |
| VS-32CTQ025STRLH3 | 800 | 800 | 13" diameter reel |
| VS-32CTQ025-1HM3 | 50 | 1000 | Antistatic plastic tubes |
| VS-32CTQ030SHM3 | 50 | 1000 | Antistatic plastic tubes |
| VS-32CTQ030STRRH3 | 800 | 800 | 13" diameter reel |
| VS-32CTQ030STRLH3 | 800 | 800 | 13" diameter reel |
| VS-32CTQ030-1HM3 | 50 | 1000 | Antistatic plastic tubes |

| LINKS TO RELATED DOCUMENTS | | |
|----------------------------|-------------------------------|--|
| Dimensions | TO-263AB (D ² PAK) | www.vishay.com/doc?95046 |
| Dimensions | TO-262AA | www.vishay.com/doc?95419 |
| Part marking information | TO-263AB (D ² PAK) | www.vishay.com/doc?95444 |
| Part marking information | TO-262AA | www.vishay.com/doc?95443 |
| Packaging information | | www.vishay.com/doc?95032 |

D²PAK

DIMENSIONS in millimeters and inches

Conforms to JEDEC[®] outline D²PAK (SMD-220)



| SYMBOL | MILLIMETERS | | INCHES | | NOTES | SYMBOL | MILLIMETERS | | INCHES | | NOTES |
|--------|-------------|-------|--------|-------|-------|--------|-------------|-------|-----------|-------|-------|
| | MIN. | MAX. | MIN. | MAX. | | | MIN. | MAX. | MIN. | MAX. | |
| A | 4.06 | 4.83 | 0.160 | 0.190 | | D1 | 6.86 | 8.00 | 0.270 | 0.315 | 3 |
| A1 | 0.00 | 0.254 | 0.000 | 0.010 | | E | 9.65 | 10.67 | 0.380 | 0.420 | 2, 3 |
| b | 0.51 | 0.99 | 0.020 | 0.039 | | E1 | 7.90 | 8.80 | 0.311 | 0.346 | 3 |
| b1 | 0.51 | 0.89 | 0.020 | 0.035 | 4 | e | 2.54 BSC | | 0.100 BSC | | |
| b2 | 1.14 | 1.78 | 0.045 | 0.070 | | H | 14.61 | 15.88 | 0.575 | 0.625 | |
| b3 | 1.14 | 1.73 | 0.045 | 0.068 | 4 | L | 1.78 | 2.79 | 0.070 | 0.110 | |
| c | 0.38 | 0.74 | 0.015 | 0.029 | | L1 | - | 1.65 | - | 0.066 | 3 |
| c1 | 0.38 | 0.58 | 0.015 | 0.023 | 4 | L2 | 1.27 | 1.78 | 0.050 | 0.070 | |
| c2 | 1.14 | 1.65 | 0.045 | 0.065 | | L3 | 0.25 BSC | | 0.010 BSC | | |
| D | 8.51 | 9.65 | 0.335 | 0.380 | 2 | L4 | 4.78 | 5.28 | 0.188 | 0.208 | |

Notes

- Dimensioning and tolerancing per ASME Y14.5 M-1994
- Dimension D and E do not include mold flash. Mold flash shall not exceed 0.127 mm (0.005") per side. These dimensions are measured at the outmost extremes of the plastic body
- Thermal pad contour optional within dimension E, L1, D1 and E1
- Dimension b1 and c1 apply to base metal only
- Datum A and B to be determined at datum plane H
- Controlling dimension: inch
- Outline conforms to JEDEC[®] outline TO-263AB

TO-262

DIMENSIONS in millimeters and inches



| SYMBOL | MILLIMETERS | | INCHES | | NOTES |
|--------|-------------|-------|-----------|-------|-------|
| | MIN. | MAX. | MIN. | MAX. | |
| A | 4.06 | 4.83 | 0.160 | 0.190 | |
| A1 | 2.03 | 3.02 | 0.080 | 0.119 | |
| b | 0.51 | 0.99 | 0.020 | 0.039 | |
| b1 | 0.51 | 0.89 | 0.020 | 0.035 | 4 |
| b2 | 1.14 | 1.78 | 0.045 | 0.070 | |
| b3 | 1.14 | 1.73 | 0.045 | 0.068 | 4 |
| c | 0.38 | 0.74 | 0.015 | 0.029 | |
| c1 | 0.38 | 0.58 | 0.015 | 0.023 | 4 |
| c2 | 1.14 | 1.65 | 0.045 | 0.065 | |
| D | 8.51 | 9.65 | 0.335 | 0.380 | 2 |
| D1 | 6.86 | 8.00 | 0.270 | 0.315 | 3 |
| E | 9.65 | 10.67 | 0.380 | 0.420 | 2, 3 |
| E1 | 7.90 | 8.80 | 0.311 | 0.346 | 3 |
| e | 2.54 BSC | | 0.100 BSC | | |
| L | 13.46 | 14.10 | 0.530 | 0.555 | |
| L1 | - | 1.65 | - | 0.065 | 3 |
| L2 | 3.56 | 3.71 | 0.140 | 0.146 | |

Notes

- (1) Dimensioning and tolerancing as per ASME Y14.5M-1994
- (2) Dimension D and E do not include mold flash. Mold flash shall not exceed 0.127 mm (0.005") per side. These dimensions are measured at the outmost extremes of the plastic body
- (3) Thermal pad contour optional within dimension E, L1, D1 and E1
- (4) Dimension b1 and c1 apply to base metal only
- (5) Controlling dimension: inches
- (6) Outline conform to JEDEC TO-262 except A1 (maximum), b (minimum) and D1 (minimum) where dimensions derived the actual package outline



Disclaimer

ALL PRODUCT, PRODUCT SPECIFICATIONS AND DATA ARE SUBJECT TO CHANGE WITHOUT NOTICE TO IMPROVE RELIABILITY, FUNCTION OR DESIGN OR OTHERWISE.

Vishay Intertechnology, Inc., its affiliates, agents, and employees, and all persons acting on its or their behalf (collectively, "Vishay"), disclaim any and all liability for any errors, inaccuracies or incompleteness contained in any datasheet or in any other disclosure relating to any product.

Vishay makes no warranty, representation or guarantee regarding the suitability of the products for any particular purpose or the continuing production of any product. To the maximum extent permitted by applicable law, Vishay disclaims (i) any and all liability arising out of the application or use of any product, (ii) any and all liability, including without limitation special, consequential or incidental damages, and (iii) any and all implied warranties, including warranties of fitness for particular purpose, non-infringement and merchantability.

Statements regarding the suitability of products for certain types of applications are based on Vishay's knowledge of typical requirements that are often placed on Vishay products in generic applications. Such statements are not binding statements about the suitability of products for a particular application. It is the customer's responsibility to validate that a particular product with the properties described in the product specification is suitable for use in a particular application. Parameters provided in datasheets and/or specifications may vary in different applications and performance may vary over time. All operating parameters, including typical parameters, must be validated for each customer application by the customer's technical experts. Product specifications do not expand or otherwise modify Vishay's terms and conditions of purchase, including but not limited to the warranty expressed therein.

Except as expressly indicated in writing, Vishay products are not designed for use in medical, life-saving, or life-sustaining applications or for any other application in which the failure of the Vishay product could result in personal injury or death. Customers using or selling Vishay products not expressly indicated for use in such applications do so at their own risk. Please contact authorized Vishay personnel to obtain written terms and conditions regarding products designed for such applications.

No license, express or implied, by estoppel or otherwise, to any intellectual property rights is granted by this document or by any conduct of Vishay. Product names and markings noted herein may be trademarks of their respective owners.

Material Category Policy

Vishay Intertechnology, Inc. hereby certifies that all its products that are identified as RoHS-Compliant fulfill the definitions and restrictions defined under Directive 2011/65/EU of The European Parliament and of the Council of June 8, 2011 on the restriction of the use of certain hazardous substances in electrical and electronic equipment (EEE) - recast, unless otherwise specified as non-compliant.

Please note that some Vishay documentation may still make reference to RoHS Directive 2002/95/EC. We confirm that all the products identified as being compliant to Directive 2002/95/EC conform to Directive 2011/65/EU.

Vishay Intertechnology, Inc. hereby certifies that all its products that are identified as Halogen-Free follow Halogen-Free requirements as per JEDEC JS709A standards. Please note that some Vishay documentation may still make reference to the IEC 61249-2-21 definition. We confirm that all the products identified as being compliant to IEC 61249-2-21 conform to JEDEC JS709A standards.



**Стандарт
Электрон
Связь**

Мы молодая и активно развивающаяся компания в области поставок электронных компонентов. Мы поставляем электронные компоненты отечественного и импортного производства напрямую от производителей и с крупнейших складов мира.

Благодаря сотрудничеству с мировыми поставщиками мы осуществляем комплексные и плановые поставки широчайшего спектра электронных компонентов.

Собственная эффективная логистика и склад в обеспечивает надежную поставку продукции в точно указанные сроки по всей России.

Мы осуществляем техническую поддержку нашим клиентам и предпродажную проверку качества продукции. На все поставляемые продукты мы предоставляем гарантию .

Осуществляем поставки продукции под контролем ВП МО РФ на предприятия военно-промышленного комплекса России , а также работаем в рамках 275 ФЗ с открытием отдельных счетов в уполномоченном банке. Система менеджмента качества компании соответствует требованиям ГОСТ ISO 9001.

Минимальные сроки поставки, гибкие цены, неограниченный ассортимент и индивидуальный подход к клиентам являются основой для выстраивания долгосрочного и эффективного сотрудничества с предприятиями радиоэлектронной промышленности, предприятиями ВПК и научно-исследовательскими институтами России.

С нами вы становитесь еще успешнее!

Наши контакты:

Телефон: +7 812 627 14 35

Электронная почта: sales@st-electron.ru

Адрес: 198099, Санкт-Петербург,
Промышленная ул, дом № 19, литера Н,
помещение 100-Н Офис 331