

IB series

Snap-in sealed pushbutton switches •
bushing Ø 12 mm • momentary



DISTINCTIVE FEATURES

Snap-in models

Compact, lightweight

Tactile feedback

Sealed to IP54



ENVIRONMENTAL SPECIFICATIONS

- Front panel sealing according to IEC 60529 : IP54
- Shock resistance : 100 g according to IEC 512-4, test 6c
- Vibration resistance : 10-500 Hz - 10 g according to IEC 512-4, test 6d
- Salt spray : IEC 512-6, test 11f
- Operating temperature : -40 °C to +85 °C (-40 °F to +185 °F)



ELECTRICAL SPECIFICATIONS

- Max. current/voltage rating with resistive load :
400 mA 32 VAC - 100 mA 48 VDC
- Initial contact resistance : 50 mΩ max.
- Insulation resistance : 1 GΩ min. at 500 VDC
- Dielectric strength : 1,000 Vrms
- Electrical life at full load : 500,000 cycles



GENERAL SPECIFICATIONS

- Panel thickness : 0.8 mm (.031) min. - 1.8 mm (.071) max.
- Total travel : 1.7 mm (.066) ± 0.3 mm
- Typical operating force : 4 N ± 3 N
- Low level or mechanical life : 1,000,000 cycles
- Soldering : 300 °C (572 °F) max. for 3 seconds

The company reserves the right to change specifications without notice.



IB series

Snap-in sealed pushbutton switches •
bushing Ø 12 mm • momentary



MATERIALS

- Case : thermoplastic UL94-V0
- Actuator : polyamide 6/6
- Bushing/bezel : polyamide 6/6
- Contacts : silver, gold plated
- Terminal seal : epoxy

APEM products may be recycled at end-of-life for the re-claiming of valuable metal components.

AGENCY APPROVAL



2 A 125 VAC/250 VAC
File E83438

Availability : consult factory for details of approved models.

Marking : to order switches marked UL, complete appropriate box of ordering format.



TERMINALS

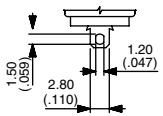

Solder lug S

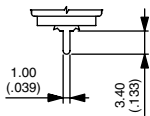

Straight P

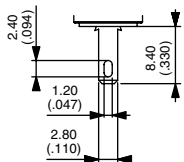

Quick-connect Z



ELECTRICAL FUNCTIONS

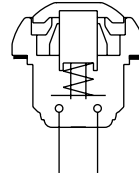

Function 3 (NO)



MOUNTING STANDARD BEZEL

PANEL CUT-OUT

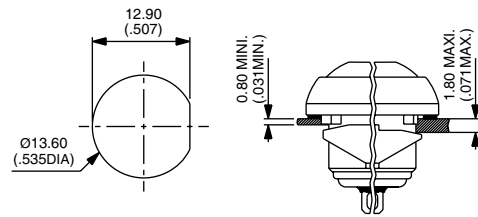

MATRIX MOUNTING

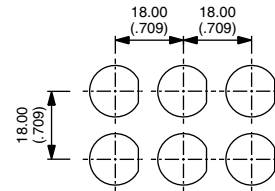

MOUNTING REDUCED MODEL

PANEL CUT-OUT

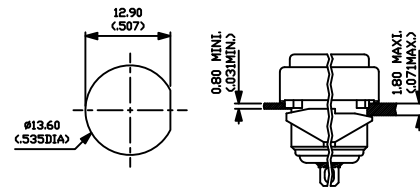

MATRIX MOUNTING

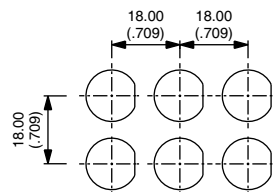

IB series

Snap-in sealed pushbutton switches •
bushing Ø 12 mm • momentary



BUILD YOUR PART NUMBER

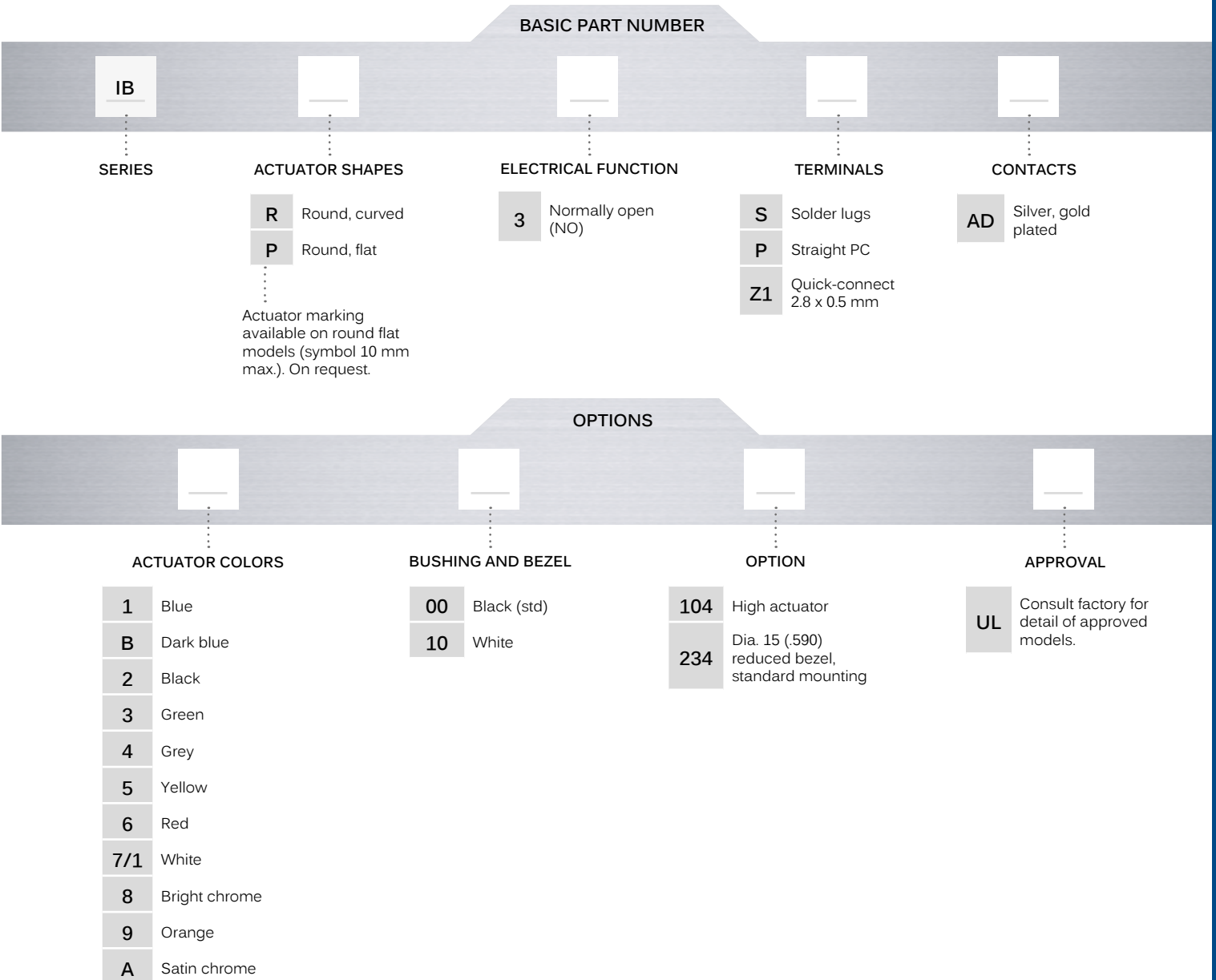

ABOUT THIS SERIES

On the following pages, you will find successively basic part numbers of switches and options in the same order as in above chart.

- Notice** : please note that not all combinations of above numbers are available. Refer to the following pages for further information.
- A sealing boot** is available to protect the switches against frost and sand (P/N U5125). See "Sealing Boots" section of website.
- Mounting accessories** : Standard hardware supplied : 1 flat seal. Plastic nut 17 mm (.669) across flats, thickness 4 mm (.157) available on request. Part number U4248.

IB series

Snap-in sealed pushbutton switches •
bushing Ø 12 mm • momentary

SOLDER LUG TERMINALS



Curved actuator
IBR3SAD  Normally Open

Flat actuator
IBP3SAD  Normally Open

→ FLAT

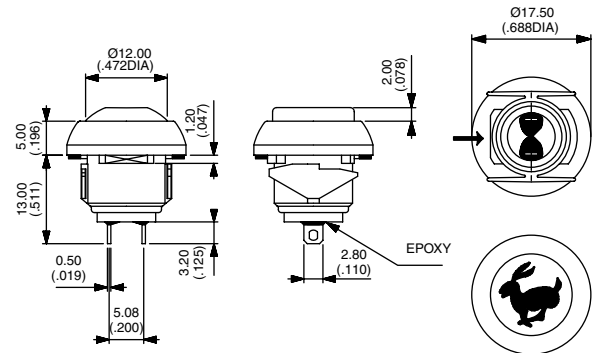

Also available with straight PC : **IB•3PAD** or quick-connect terminals : **IB•3Z1AD**

ACTUATOR COLORS

BASIC P/N



- 1 Blue
- B Dark blue
- 2 Black
- 3 Green
- 4 Grey
- 5 Yellow
- 6 Red
- 7/1 White
- 8 Bright chrome
- 9 Orange
- A Satin chrome

BUSHING AND BEZEL

BASIC P/N



- 00 Black (standard)
- 10 White

IB series

Snap-in sealed pushbutton switches •
bushing \varnothing 12 mm • momentary

OPTIONS



- 104 High actuator
- 234 Dia. 15 (.590) reduced bezel, standard mounting

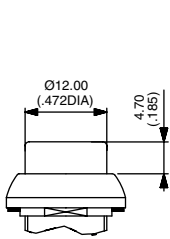

104 IBR

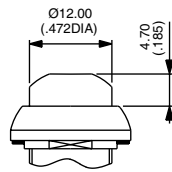

104 IBP

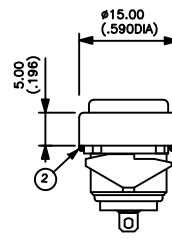

234

AGENCY APPROVAL



- UL**
Availability : consult factory for details of approved models.
Marking : to order switches marked UL, complete appropriate box of ordering format.



Стандарт Электрон Связь

Мы молодая и активно развивающаяся компания в области поставок электронных компонентов. Мы поставляем электронные компоненты отечественного и импортного производства напрямую от производителей и с крупнейших складов мира.

Благодаря сотрудничеству с мировыми поставщиками мы осуществляем комплексные и плановые поставки широчайшего спектра электронных компонентов.

Собственная эффективная логистика и склад в обеспечивает надежную поставку продукции в точно указанные сроки по всей России.

Мы осуществляем техническую поддержку нашим клиентам и предпродажную проверку качества продукции. На все поставляемые продукты мы предоставляем гарантию .

Осуществляем поставки продукции под контролем ВП МО РФ на предприятия военно-промышленного комплекса России , а также работаем в рамках 275 ФЗ с открытием отдельных счетов в уполномоченном банке. Система менеджмента качества компании соответствует требованиям ГОСТ ISO 9001.

Минимальные сроки поставки, гибкие цены, неограниченный ассортимент и индивидуальный подход к клиентам являются основой для выстраивания долгосрочного и эффективного сотрудничества с предприятиями радиоэлектронной промышленности, предприятиями ВПК и научно-исследовательскими институтами России.

С нами вы становитесь еще успешнее!

Наши контакты:

Телефон: +7 812 627 14 35

Электронная почта: sales@st-electron.ru

Адрес: 198099, Санкт-Петербург,
Промышленная ул, дом № 19, литера Н,
помещение 100-Н Офис 331