

## FEATURES

- **Smallest Pin-Compatible Quad DACs:**  
 LTC2609: 16 Bits  
 LTC2619: 14 Bits  
 LTC2629: 12 Bits
- **Guaranteed Monotonic Over Temperature**
- **Separate Reference Inputs**
- **27 Selectable Addresses**
- 400kHz I<sup>2</sup>C™ Interface
- Wide 2.7V to 5.5V Supply Range
- Low Power Operation: 250µA per DAC at 3V
- Individual Channel Power Down to 1µA (Max)
- High Rail-to-Rail Output Drive (±15mA, Min)
- Ultralow Crosstalk Between DACs (5µV)
- LTC2609/LTC2619/LTC2629: Power-On Reset to Zero-Scale
- LTC2609-1/LTC2619-1/LTC2629-1: Power-On Reset to Mid-Scale
- Tiny 16-Lead Narrow SSOP Package

## APPLICATIONS

- Mobile Communications
- Process Control and Industrial Automation
- Automatic Test Equipment and Instrumentation

## DESCRIPTION

The LTC<sup>®</sup>2609/LTC2619/LTC2629 are quad 16-, 14- and 12-bit, 2.7V to 5.5V rail-to-rail voltage output DACs in a 16-lead SSOP package. They have built-in high performance output buffers and are guaranteed monotonic.

These parts establish new board-density benchmarks for 16- and 14-bit DACs and advance performance standards for output drive and load regulation in single-supply, voltage-output DACs.

The parts use a 2-wire, I<sup>2</sup>C compatible serial interface. The LTC2609/LTC2619/LTC2629 operate in both the standard mode (clock rate of 100kHz) and the fast mode (clock rate of 400kHz).

The LTC2609/LTC2619/LTC2629 incorporate a power-on reset circuit. During power-up, the voltage outputs rise less than 10mV above zero-scale; after power-up, they stay at zero-scale until a valid write and update take place. The power-on reset circuit resets the LTC2609-1/LTC2619-1/LTC2629-1 to mid-scale. The voltage outputs stay at mid-scale until a valid write and update take place.

LT, LT, LTC, LTM, Linear Technology and the Linear logo are registered trademarks of Linear Technology Corporation. All other trademarks are the property of their respective owners. Protected by U.S. Patents including 5396245. Patent pending.

## BLOCK DIAGRAM

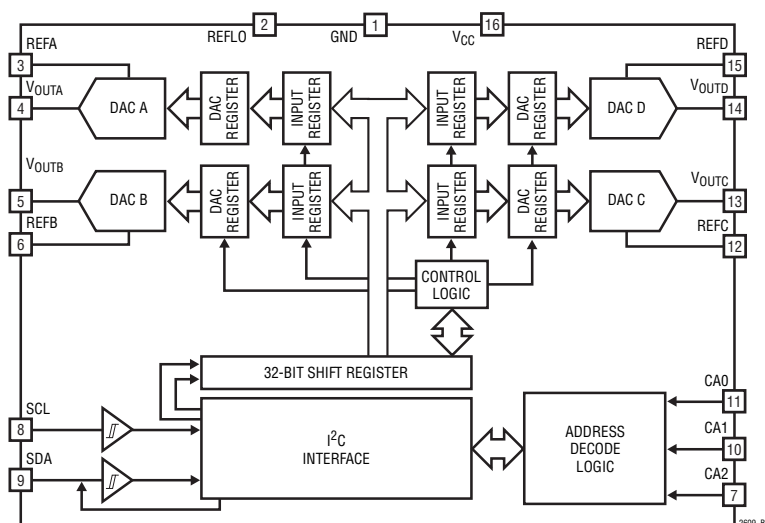

**Differential Nonlinearity  
(LTC2609)**

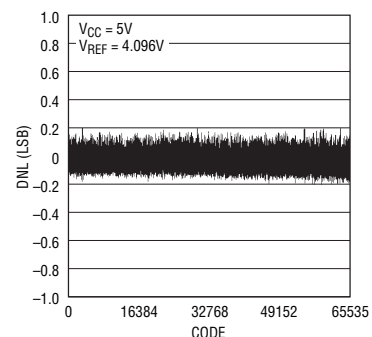

# LTC2609/LTC2619/LTC2629

## ABSOLUTE MAXIMUM RATINGS (Note 1)

Any Pin to GND .....	-0.3V to 6V
Any Pin to $V_{CC}$ .....	-6V to 0.3V
Maximum Junction Temperature.....	125°C
Storage Temperature Range.....	-65°C to 125°C
Lead Temperature (Soldering, 10 sec) .....	300°C
Operating Temperature Range:	
LTC2609C/LTC2619C/LTC2629C	
LTC2609C-1/LTC2619C-1/LTC2629C-1 ....	0°C to 70°C
LTC2609I/LTC2619I/LTC2629I	
LTC2609I-1/LTC2619I-1/LTC2629I-1 ....	-40°C to 85°C

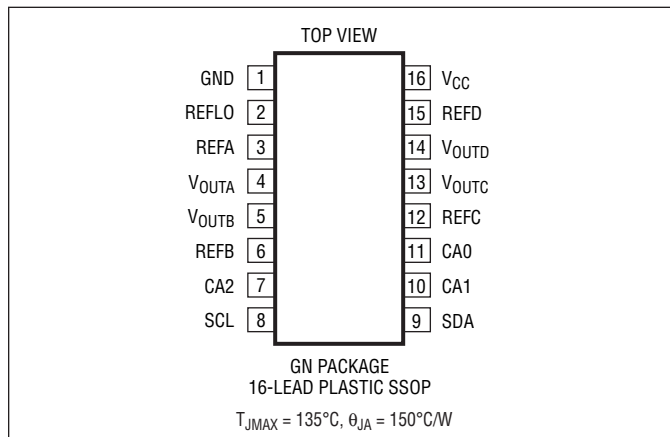

## ORDER INFORMATION

LEAD FREE FINISH	TAPE AND REEL	PART MARKING*	PACKAGE DESCRIPTION	TEMPERATURE RANGE
LTC2609CGN#PBF	LTC2609CGN#TRPBF	2609	16-Lead Plastic SSOP	0°C to 70°C
LTC2609CGN-1#PBF	LTC2609CGN-1#TRPBF	26091	16-Lead Plastic SSOP	0°C to 70°C
LTC2609IGN#PBF	LTC2609IGN#TRPBF	2609I	16-Lead Plastic SSOP	-40°C to 85°C
LTC2609IGN-1#PBF	LTC2609IGN-1#TRPBF	2619I1	16-Lead Plastic SSOP	-40°C to 85°C
LTC2619CGN#PBF	LTC2619CGN#TRPBF	2619	16-Lead Plastic SSOP	0°C to 70°C
LTC2619CGN-1#PBF	LTC2619CGN-1#TRPBF	26191	16-Lead Plastic SSOP	0°C to 70°C
LTC2619IGN#PBF	LTC2619IGN#TRPBF	2619I	16-Lead Plastic SSOP	-40°C to 85°C
LTC2619IGN-1#PBF	LTC2619IGN-1#TRPBF	2619I1	16-Lead Plastic SSOP	-40°C to 85°C
LTC2629CGN#PBF	LTC2629CGN#TRPBF	2629	16-Lead Plastic SSOP	0°C to 70°C
LTC2629CGN-1#PBF	LTC2629CGN-1#TRPBF	26291	16-Lead Plastic SSOP	0°C to 70°C
LTC2629IGN#PBF	LTC2629IGN#TRPBF	2629I	16-Lead Plastic SSOP	-40°C to 85°C
LTC2629IGN-1#PBF	LTC2629IGN-1#TRPBF	2629I1	16-Lead Plastic SSOP	-40°C to 85°C

Consult LTC Marketing for parts specified with wider operating temperature ranges. \*The temperature grade is identified by a label on the shipping container.

For more information on lead free part marking, go to: <http://www.linear.com/leadfree/>

For more information on tape and reel specifications, go to: <http://www.linear.com/tapeandreel/>

**ELECTRICAL CHARACTERISTICS** The ● denotes the specifications which apply over the full operating temperature range, otherwise specifications are at  $T_A = 25^\circ\text{C}$ . REFA = REFB = REFC = REFD = 4.096V ( $V_{CC} = 5\text{V}$ ), REFA = REFB = REFC = REFD = 2.048V ( $V_{CC} = 2.7\text{V}$ ). REFLO = 0V,  $V_{OUT}$  = unloaded, unless otherwise noted.

SYMBOL	PARAMETER	CONDITIONS	LTC2629/LTC2629-1			LTC2619/LTC2619-1			LTC2609/LTC2609-1			UNITS
			MIN	TYP	MAX	MIN	TYP	MAX	MIN	TYP	MAX	
<b>DC Performance</b>												
	Resolution		●	12		14		16			Bits	
	Monotonicity	(Note 2)	●	12		14		16			Bits	
DNL	Differential Nonlinearity	(Note 2)	●		±0.5		±1		±1		LSB	
INL	Integral Nonlinearity	(Note 2)	●	±1	±4	±4	±16	±16	±64		LSB	
	Load Regulation	$V_{REF} = V_{CC} = 5\text{V}$ , Mid-Scale $I_{OUT} = 0\text{mA}$ to 15mA Sourcing	●	0.02	0.125	0.1	0.5	0.3	2		LSB/mA	
		$I_{OUT} = 0\text{mA}$ to 15mA Sinking	●	0.02	0.125	0.1	0.5	0.4	2		LSB/mA	
		$V_{REF} = V_{CC} = 2.7\text{V}$ , Mid-Scale $I_{OUT} = 0\text{mA}$ to 7.5mA Sourcing	●	0.04	0.25	0.2	1	0.7	4		LSB/mA	
		$I_{OUT} = 0\text{mA}$ to 7.5mA Sinking	●	0.05	0.25	0.2	1	0.8	4		LSB/mA	
ZSE	Zero-Scale Error	Code = 0	●	1.5	9	1.5	9	1.5	9		mV	
$V_{OS}$	Offset Error	(Note 4)	●	±1	±9	±1	±9	±1	±9		mV	
	$V_{OS}$ Temperature Coefficient			±6		±6		±6			$\mu\text{V}/^\circ\text{C}$	
GE	Gain Error		●	±0.1	±0.7	±0.1	±0.7	±0.1	±0.7		%FSR	
	Gain Temperature Coefficient			±3		±3		±3			ppm/ $^\circ\text{C}$	

The ● denotes the specifications which apply over the full operating temperature range, otherwise specifications are at  $T_A = 25^\circ\text{C}$ . REFA = REFB = REFC = REFD = 4.096V ( $V_{CC} = 5\text{V}$ ), REFA = REFB = REFC = REFD = 2.048V ( $V_{CC} = 2.7\text{V}$ ). REFLO = 0V,  $V_{OUT}$  = unloaded, unless otherwise noted. (Note 9)

SYMBOL	PARAMETER	CONDITIONS		MIN	TYP	MAX	UNITS
PSR	Power Supply Rejection	$V_{CC} \pm 10\%$			-80		dB
$R_{OUT}$	DC Output Impedance	$V_{REF} = V_{CC} = 5\text{V}$ , Mid-Scale; $-15\text{mA} \leq I_{OUT} \leq 15\text{mA}$	●		0.030	0.15	$\Omega$
		$V_{REF} = V_{CC} = 2.7\text{V}$ , Mid-Scale; $-7.5\text{mA} \leq I_{OUT} \leq 7.5\text{mA}$	●		0.035	0.15	$\Omega$
	DC Crosstalk (Note 10)	Due to Full-Scale Output Change (Note 11)			±5		$\mu\text{V}$
		Due to Load Current Change			±4		$\mu\text{V}/\text{mA}$
		Due to Powering Down (Per Channel)			±4		$\mu\text{V}$
ISC	Short-Circuit Output Current	$V_{CC} = 5.5\text{V}$ , $V_{REF} = 5.5\text{V}$ Code: Zero-Scale; Forcing Output to $V_{CC}$ Code: Full-Scale; Forcing Output to GND	●	15	36	60	mA
			●	15	36	60	mA
		$V_{CC} = 2.7\text{V}$ , $V_{REF} = 2.7\text{V}$ Code: Zero-Scale; Forcing Output to $V_{CC}$ Code: Full-Scale; Forcing Output to GND	●	7.5	22	50	mA
			●	7.5	30	50	mA

**Reference Input**

	Input Voltage Range		●	0		$V_{CC}$	V
	Resistance	Normal Mode	●	88	125	160	k $\Omega$
	Capacitance				14		pF
$I_{REF}$	Reference Current, Power Down Mode	DAC Powered Down	●		0.001	1	$\mu\text{A}$

**Power Supply**

$V_{CC}$	Positive Supply Voltage	For Specified Performance	●	2.7		5.5	V
$I_{CC}$	Supply Current	$V_{CC} = 5\text{V}$ (Note 3)	●		1.25	2	mA
		$V_{CC} = 3\text{V}$ (Note 3)	●		1	1.6	mA
		DAC Powered Down (Note 3) $V_{CC} = 5\text{V}$	●		0.35	1	$\mu\text{A}$
		DAC Powered Down (Note 3) $V_{CC} = 3\text{V}$	●		0.15	1	$\mu\text{A}$

# LTC2609/LTC2619/LTC2629

**ELECTRICAL CHARACTERISTICS** The ● denotes the specifications which apply over the full operating temperature range, otherwise specifications are at  $T_A = 25^\circ\text{C}$ . REFA = REFB = REFC = REFD = 4.096V ( $V_{CC} = 5\text{V}$ ), REFA = REFB = REFC = REFD = 2.048V ( $V_{CC} = 2.7\text{V}$ ). REFLO = 0V,  $V_{OUT}$  = unloaded, unless otherwise noted. (Note 9)

## Digital I/O (Note 9)

$V_{IL}$	Low Level Input Voltage (SDA and SCL)		●		$0.3V_{CC}$	V
$V_{IH}$	High Level Input Voltage (SDA and SCL)		●	$0.7V_{CC}$		V
$V_{IL(CAn)}$	Low Level Input Voltage on $CA_n$ ( $n = 0, 1, 2$ )	See Test Circuit 1	●		$0.15V_{CC}$	V
$V_{IH(CAn)}$	High Level Input Voltage on $CA_n$ ( $n = 0, 1, 2$ )	See Test Circuit 1	●	$0.85V_{CC}$		V
$R_{INH}$	Resistance from $CA_n$ ( $n = 0, 1, 2$ ) to $V_{CC}$ to Set $CA_n = V_{CC}$	See Test Circuit 2	●		10	k $\Omega$
$R_{INL}$	Resistance from $CA_n$ ( $n = 0, 1, 2$ ) to GND to Set $CA_n = \text{GND}$	See Test Circuit 2	●		10	k $\Omega$
$R_{INF}$	Resistance from $CA_n$ ( $n = 0, 1, 2$ ) to $V_{CC}$ or GND to Set $CA_n = \text{Float}$	See Test Circuit 2	●	2		M $\Omega$
$V_{OL}$	Low Level Output Voltage	Sink Current = 3mA	●	0	0.4	V
$t_{OF}$	Output Fall Time	$V_O = V_{IH(MIN)}$ to $V_O = V_{IL(MAX)}$ , $C_B = 10\text{pF}$ to 400pF (Note 7)	●	$20 + 0.1C_B$	250	ns
$t_{SP}$	Pulse Width of Spikes Suppressed by Input Filter		●	0	50	ns
$I_{IN}$	Input Leakage	$0.1V_{CC} \leq V_{IN} \leq 0.9V_{CC}$	●		1	$\mu\text{A}$
$C_{IN}$	I/O Pin Capacitance	(Note 12)	●		10	pF
$C_B$	Capacitive Load for Each Bus Line		●		400	pF
$C_{CAX}$	External Capacitive Load on Address Pins $CA_n$ ( $n = 0, 1, 2$ )		●		10	pF

The ● denotes the specifications which apply over the full operating temperature range, otherwise specifications are at  $T_A = 25^\circ\text{C}$ . REFA = REFB = REFC = REFD = 4.096V ( $V_{CC} = 5\text{V}$ ), REFA = REFB = REFC = REFD = 2.048V ( $V_{CC} = 2.7\text{V}$ ). REFLO = 0V,  $V_{OUT}$  = unloaded, unless otherwise noted.

SYMBOL	PARAMETER	CONDITIONS	LTC2629/LTC2629-1			LTC2619/LTC2619-1			LTC2609/LTC2609-1			UNITS
			MIN	TYP	MAX	MIN	TYP	MAX	MIN	TYP	MAX	
<b>AC Performance</b>												
$t_s$	Settling Time (Note 5)	$\pm 0.024\%$ ( $\pm 1\text{LSB}$ at 12 Bits)	7			7			7			$\mu\text{s}$
		$\pm 0.006\%$ ( $\pm 1\text{LSB}$ at 14 Bits)				9			9			$\mu\text{s}$
		$\pm 0.0015\%$ ( $\pm 1\text{LSB}$ at 16 Bits)							10			$\mu\text{s}$
$e_n$	Settling Time for 1LSB Step (Note 6)	$\pm 0.024\%$ ( $\pm 1\text{LSB}$ at 12 Bits)	2.7			2.7			2.7			$\mu\text{s}$
		$\pm 0.006\%$ ( $\pm 1\text{LSB}$ at 14 Bits)				4.8			4.8			$\mu\text{s}$
		$\pm 0.0015\%$ ( $\pm 1\text{LSB}$ at 16 Bits)							5.2			$\mu\text{s}$
	Voltage Output Slew Rate		0.7			0.7			0.7			V/ $\mu\text{s}$
	Capacitive Load Driving		1000			1000			1000			pF
	Glitch Impulse	At Mid-Scale Transition	12			12			12			nV • s
	Multiplying Bandwidth		180			180			180			kHz
$e_n$	Output Voltage Noise Density	At $f = 1\text{kHz}$	120			120			120			nV/ $\sqrt{\text{Hz}}$
		At $f = 10\text{kHz}$	100			100			100			nV/ $\sqrt{\text{Hz}}$
	Output Voltage Noise	0.1Hz to 10Hz	15			15			15			$\mu\text{V}_{\text{p-p}}$

## TIMING CHARACTERISTICS

The ● denotes the specifications which apply over the full operating temperature range, otherwise specifications are at  $T_A = 25^\circ\text{C}$ . (See Figure 1) (Notes 8, 9)

SYMBOL	PARAMETER	CONDITIONS	MIN	TYP	MAX	UNITS
<b><math>V_{CC} = 2.7\text{V}</math> to <math>5.5\text{V}</math></b>						
$f_{SCL}$	SCL Clock Frequency		●	0	400	kHz
$t_{HD(STA)}$	Hold Time (Repeated) Start Condition		●	0.6		$\mu\text{s}$
$t_{LOW}$	Low Period of the SCL Clock Pin		●	1.3		$\mu\text{s}$
$t_{HIGH}$	High Period of the SCL Clock Pin		●	0.6		$\mu\text{s}$
$t_{SU(STA)}$	Set-Up Time for a Repeated Start Condition		●	0.6		$\mu\text{s}$
$t_{HD(DAT)}$	Data Hold Time		●	0	0.9	$\mu\text{s}$
$t_{SU(DAT)}$	Data Set-Up Time		●	100		ns
$t_r$	Rise Time of Both SDA and SCL Signals	(Note 7)	●	$20 + 0.1C_B$	300	ns
$t_f$	Fall Time of Both SDA and SCL Signals	(Note 7)	●	$20 + 0.1C_B$	300	ns
$t_{SU(STO)}$	Set-Up Time for Stop Condition		●	0.6		$\mu\text{s}$
$t_{BUF}$	Bus Free Time Between a Stop and Start Condition		●	1.3		$\mu\text{s}$
$t_1$	Falling Edge of 9th Clock of the 3rd Input Byte to LDAC High or Low Transition		●	400		ns
$t_2$	LDAC Low Pulse Width		●	20		ns

**Note 1:** Stresses beyond those listed under Absolute Maximum Ratings may cause permanent damage to the device. Exposure to any Absolute Maximum Rating condition for extended periods may affect device reliability and lifetime.

**Note 2:** Linearity and monotonicity are defined from code  $k_L$  to code  $2^N - 1$ , where  $N$  is the resolution and  $k_L$  is given by  $k_L = 0.016(2^N/V_{REF})$ , rounded to the nearest whole code. For  $V_{REF} = 4.096\text{V}$  and  $N = 16$ ,  $k_L = 256$  and linearity is defined from code 256 to code 65,535.

**Note 3:** SDA, SCL at 0V or  $V_{CC}$ , CA0, CA1 and CA2 floating.

**Note 4:** Inferred from measurement at code  $k_L$  (see Note 2) and at full-Scale.

**Note 5:**  $V_{CC} = 5\text{V}$ ,  $V_{REF} = 4.096\text{V}$ . DAC is stepped 1/4 scale to 3/4 scale and 3/4 scale to 1/4 scale. Load is 2k in parallel with 200pF to GND.

**Note 6:**  $V_{CC} = 5\text{V}$ ,  $V_{REF} = 4.096\text{V}$ . DAC is stepped  $\pm 1\text{LSB}$  between half scale and half scale - 1. Load is 2k in parallel with 200pF to GND.

**Note 7:**  $C_B$  = capacitance of one bus line in pF.

**Note 8:** All values refer to  $V_{IH(MIN)}$  and  $V_{IL(MAX)}$  levels.

**Note 9:** These specifications apply to LTC2609/LTC2609-1, LTC2619/LTC2619-1, LTC2629/LTC2629-1.

**Note 10:** DC crosstalk is measured with  $V_{CC} = 5\text{V}$ , REFA = REFB = REFC = REFD = 4.096V, with the measured DAC at mid-scale, unless otherwise noted.

**Note 11:**  $R_L = 2\text{k}\Omega$  to GND or  $V_{CC}$ .

**Note 12:** Guaranteed by design and not production tested.

## TYPICAL PERFORMANCE CHARACTERISTICS

### LTC2609

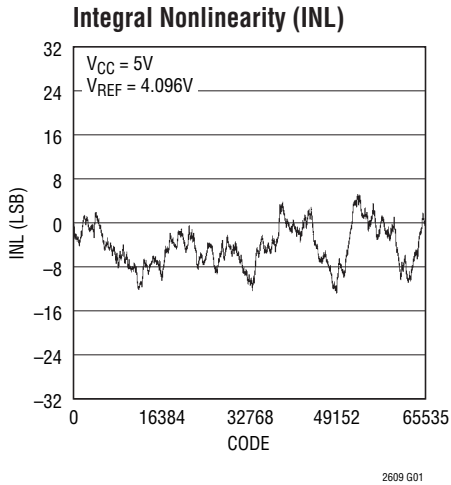

2609 G01

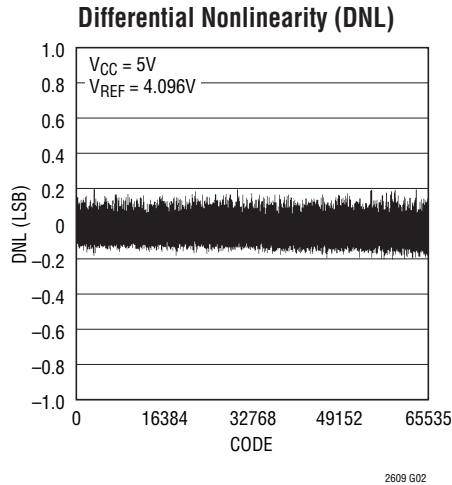

2609 G02

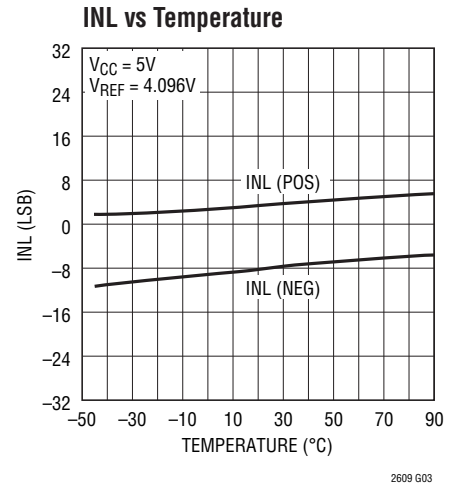

2609 G03

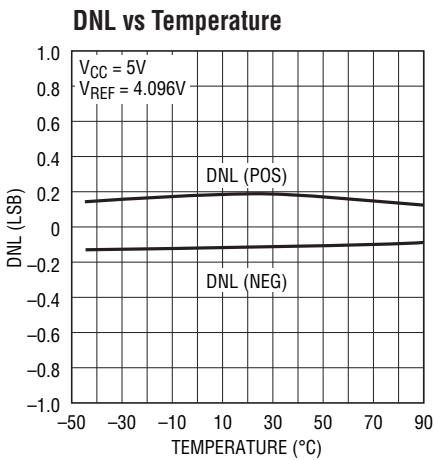

2609 G04

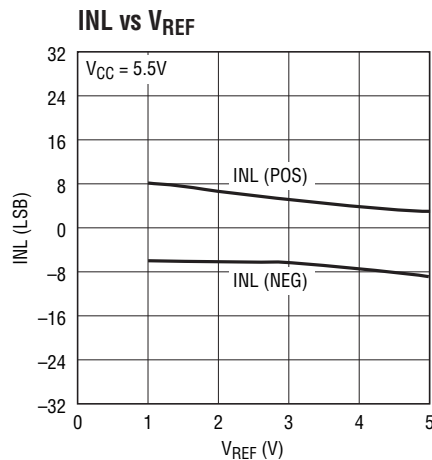

2609 G05

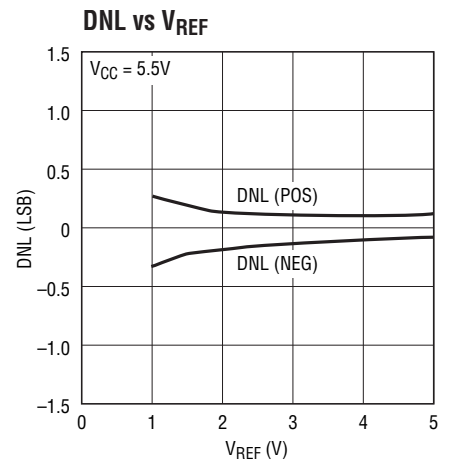

2609 G06

### Settling to $\pm 1LSB$

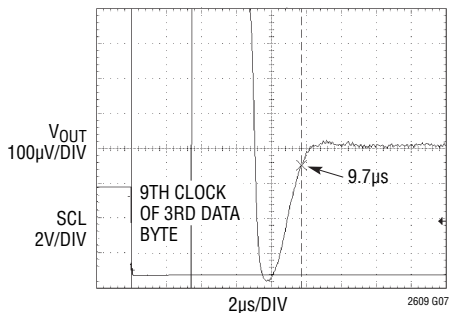

2609 G07

$V_{CC} = 5V$ ,  $V_{REF} = 4.096V$   
 1/4 SCALE TO 3/4 SCALE STEP  
 $R_L = 2k$ ,  $C_L = 200pF$   
 AVERAGE OF 2048 EVENTS

### Settling of Full-Scale Step

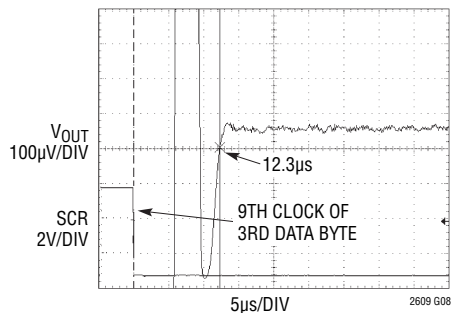

2609 G08

SETTLING TO  $\pm 1LSB$   
 $V_{CC} = 5V$ ,  $V_{REF} = 4.096V$   
 CODE 512 TO 65535 STEP  
 AVERAGE OF 2048 EVENTS

# TYPICAL PERFORMANCE CHARACTERISTICS

## LTC2619

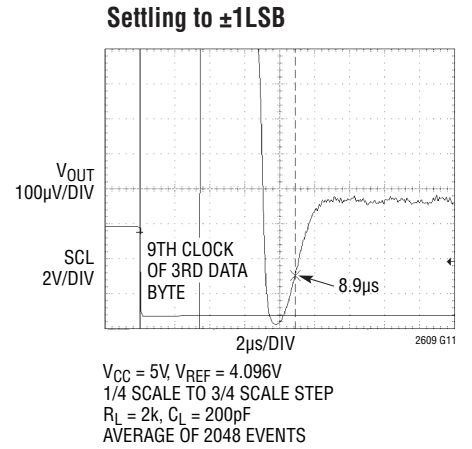
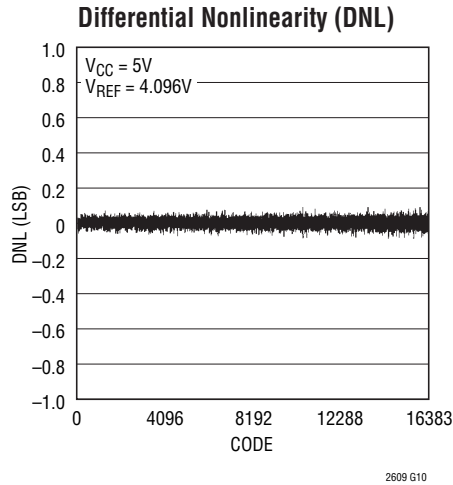
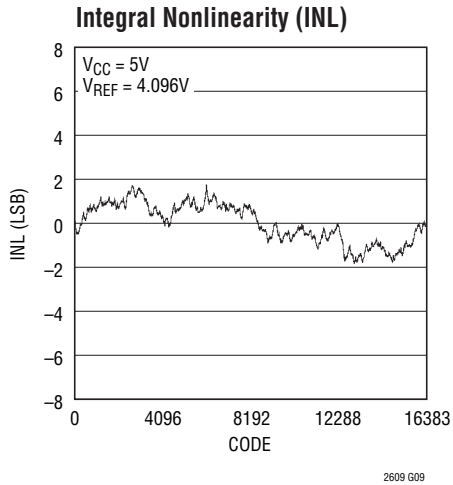

## LTC2629

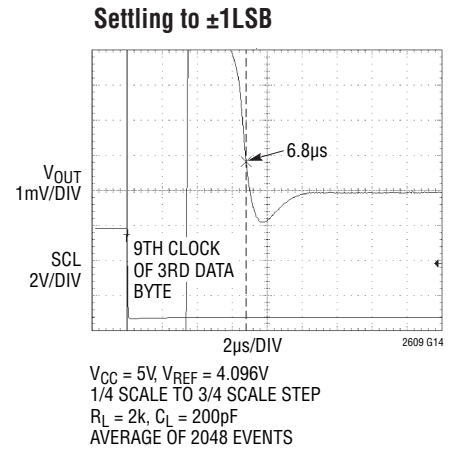
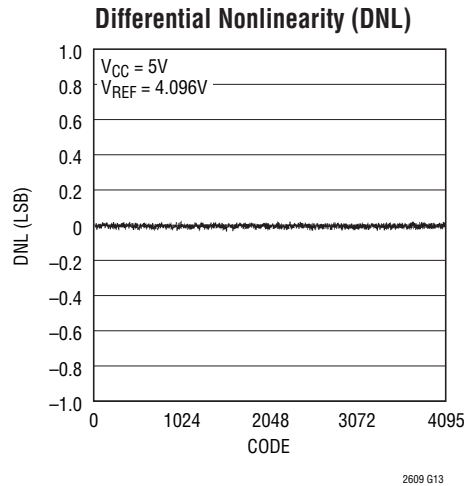
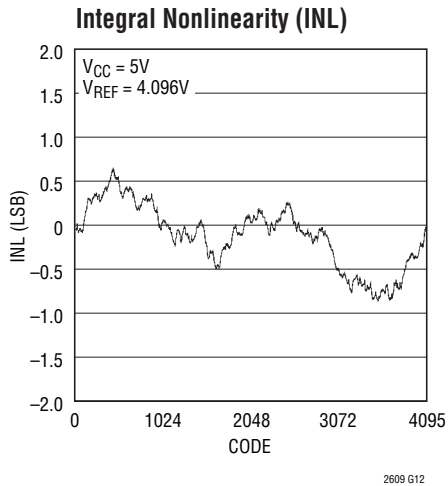

## TYPICAL PERFORMANCE CHARACTERISTICS

LTC2609/LTC2619/LTC2629

**Current Limiting**

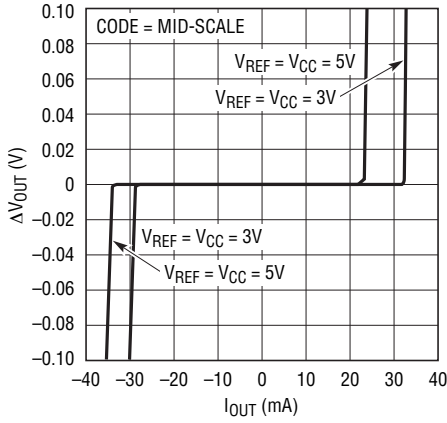

2609 G15

**Load Regulation**

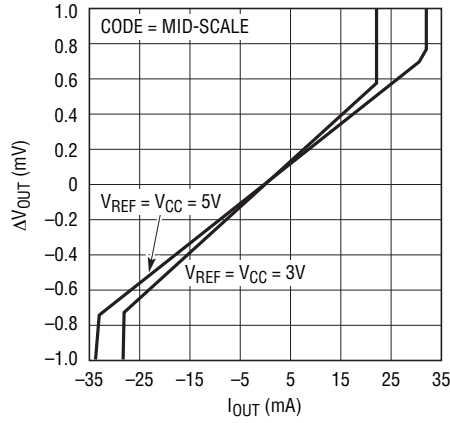

2609 G16

**Offset Error vs Temperature**

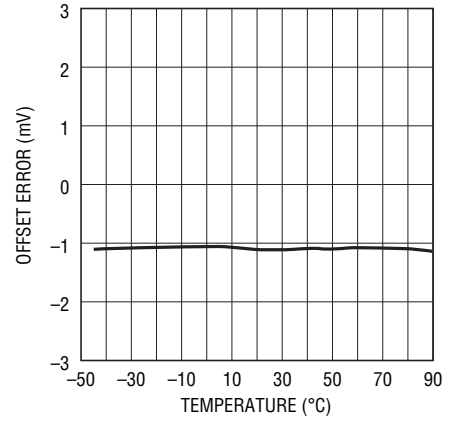

2609 G17

**Zero-Scale Error vs Temperature**

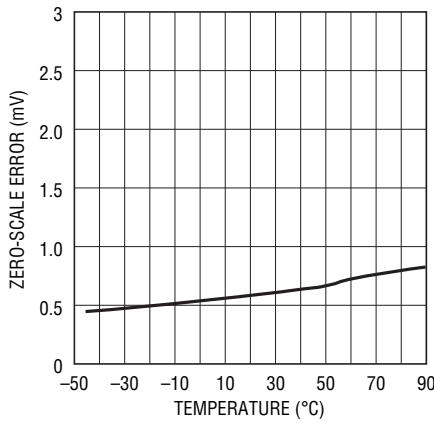

2609 G18

**Gain Error vs Temperature**

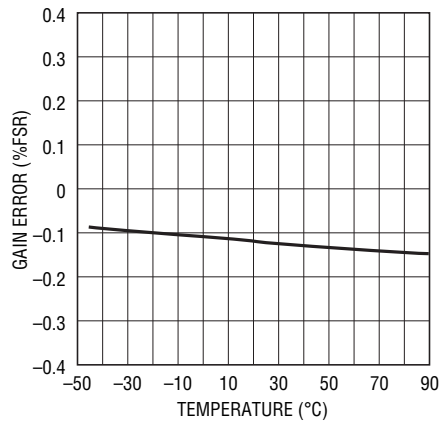

2609 G19

**Offset Error vs VCC**

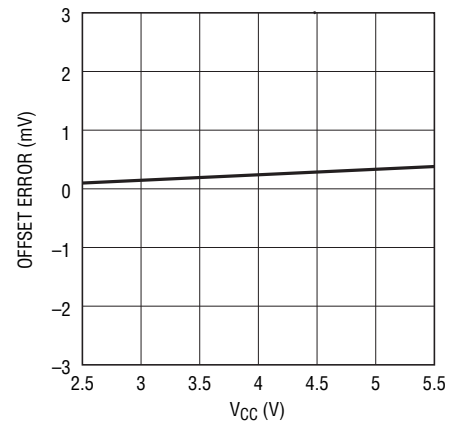

2609 G20

**Gain Error vs VCC**

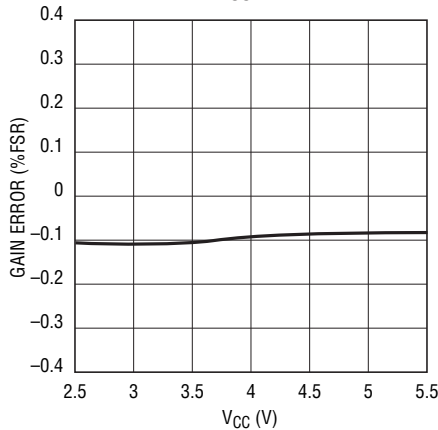

2609 G21

**ICC Shutdown vs VCC**

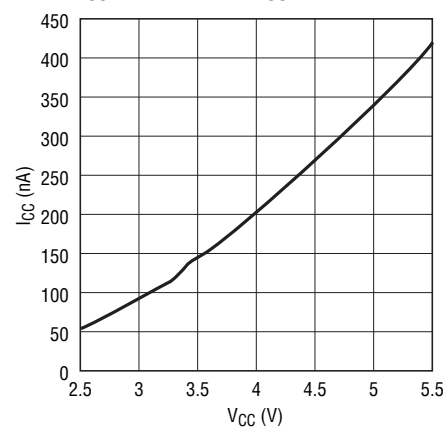

2609 G22



# TYPICAL PERFORMANCE CHARACTERISTICS

LTC2609/LTC2619/LTC2629

**Large-Signal Response**

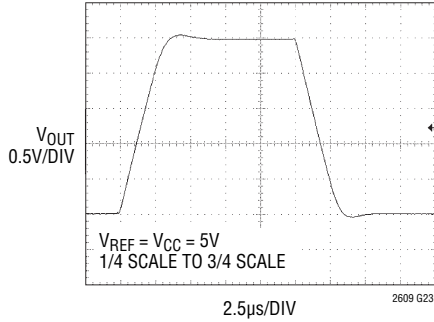

**Mid-Scale Glitch Impulse**

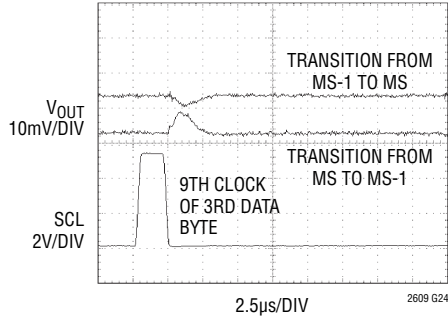

**Power-On Reset Glitch**

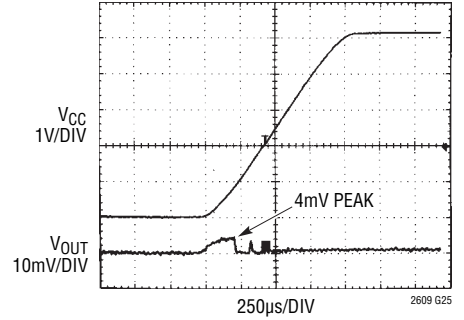

**Headroom at Rails vs Output Current**

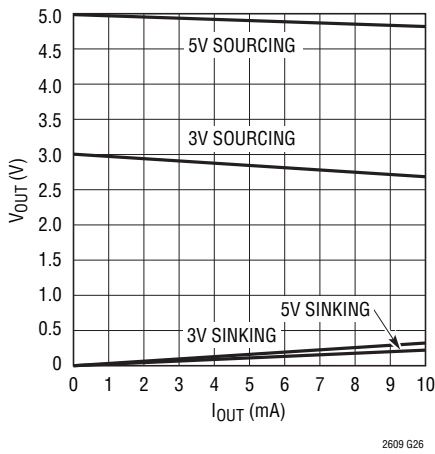

**Power-On Reset to Mid-Scale**

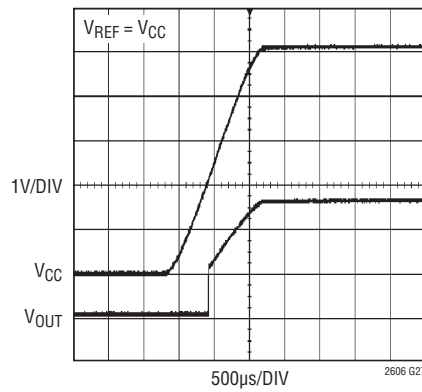

**Supply Current vs Logic Voltage**

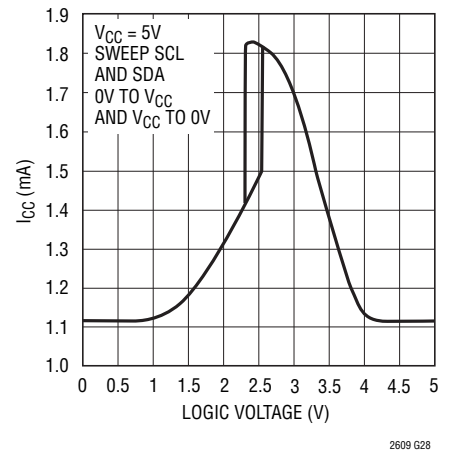

## TYPICAL PERFORMANCE CHARACTERISTICS

LTC2609/LTC2619/LTC2629

**Multiplying Bandwidth**

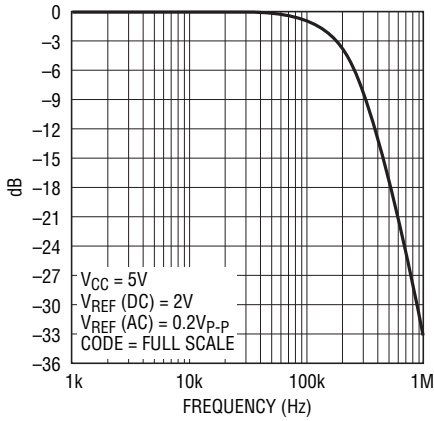

**Output Voltage Noise, 0.1Hz to 10Hz**

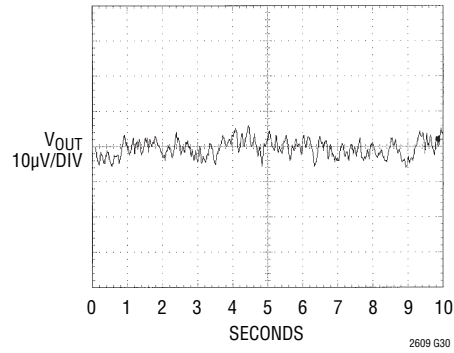

**Short-Circuit Output Current vs  $V_{OUT}$  (Sinking)**

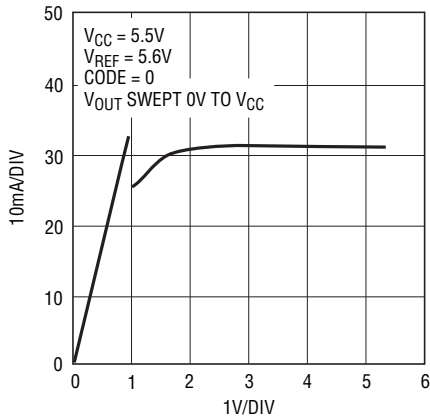

**Short-Circuit Output Current vs  $V_{OUT}$  (Sourcing)**

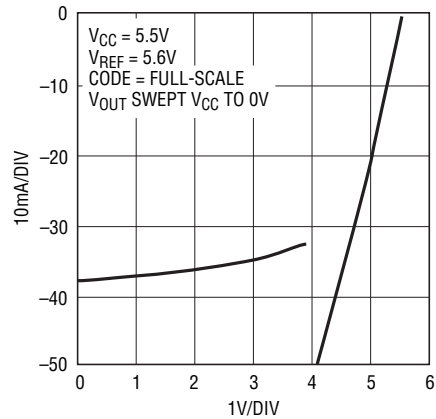

## PIN FUNCTIONS

**GND (Pin 1):** Analog Ground.

**REFLO (Pin 2):** Reference Low. The voltage at this pin sets the zero-scale (ZS) voltage of all DACs. This pin can be raised up to 1V above ground at  $V_{CC} = 5V$  or 100mV above ground at  $V_{CC} = 3V$ .

**REFA to REFD (Pins 3, 6, 12, 15):** Reference Voltage Inputs for each DAC.  $REFx$  sets the full-scale voltage of the DACs.  $REFLO \leq REFx \leq V_{CC}$ .

**$V_{OUTA}$  to  $V_{OUTD}$  (Pins 4, 5, 13, 14):** DAC Analog Voltage Outputs. The output range is from REFLO to  $REFx$ .

**CA2 (Pin 7):** Chip Address Bit 2. Tie this pin to  $V_{CC}$ , GND or leave it floating to select an I<sup>2</sup>C slave address for the part (Table 1).

**SCL (Pin 8):** Serial Clock Input Pin. Data is shifted into the SDA pin at the rising edges of the clock. This high impedance pin requires a pull-up resistor or current source to  $V_{CC}$ .

**SDA (Pin 9):** Serial Data Bidirectional Pin. Data is shifted into the SDA pin and acknowledged by the SDA pin. This pin is high impedance pin while data is shifted in and is an open-drain N-channel output during acknowledgment. SDA requires a pull-up resistor or current source to  $V_{CC}$ .

**CA1 (Pin 10):** Chip Address Bit 1. Tie this pin to  $V_{CC}$ , GND or leave it floating to select an I<sup>2</sup>C slave address for the part (Table 1).

**CA0 (Pin 11):** Chip Address Bit 0. Tie this pin to  $V_{CC}$ , GND or leave it floating to select an I<sup>2</sup>C slave address for the part (Table 1).

**$V_{CC}$  (Pin 16):** Supply Voltage Input.  $2.7V \leq V_{CC} \leq 5.5V$ .

**BLOCK DIAGRAM**

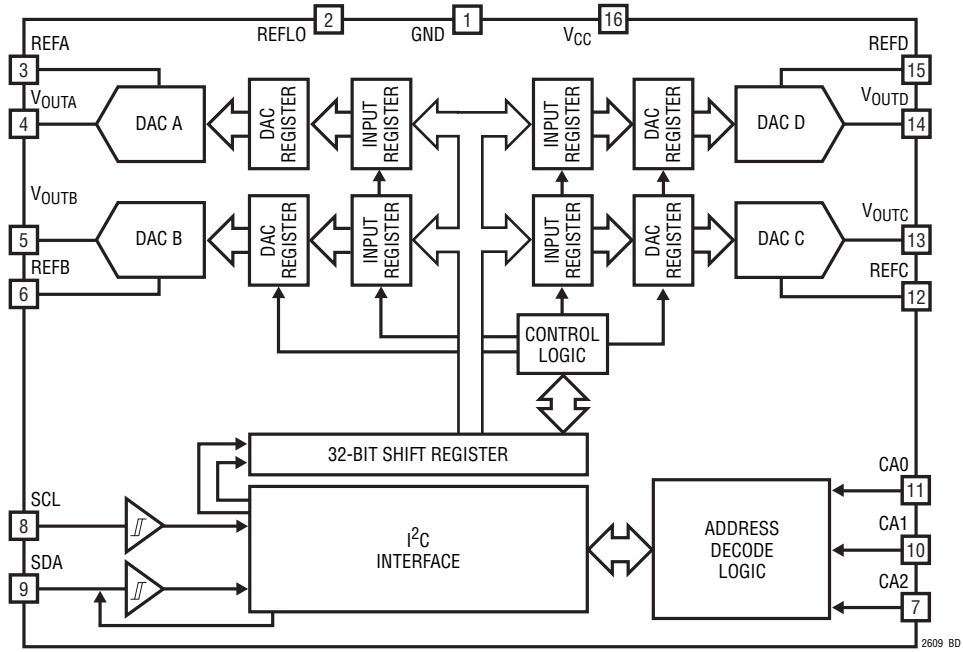

## TEST CIRCUITS

Test Circuit 1

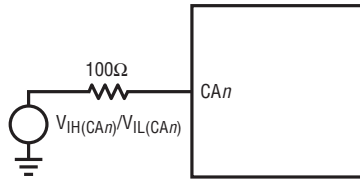

Test Circuit 2

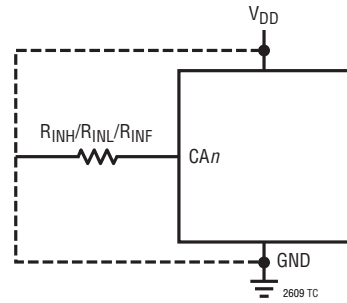

## TIMING DIAGRAM

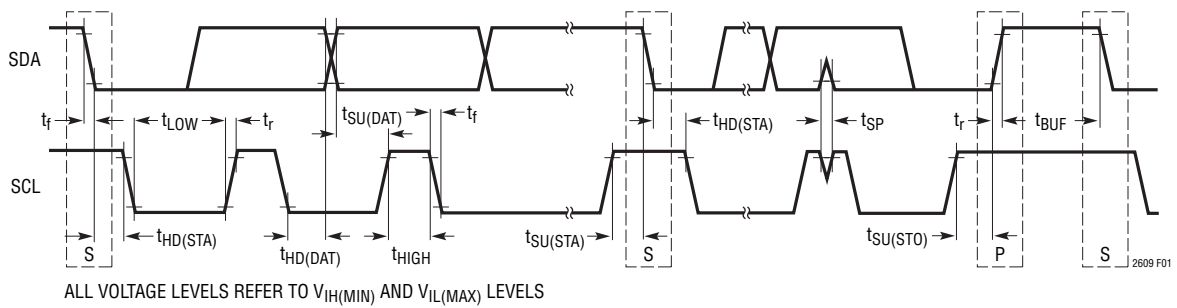

Figure 1

## OPERATION

### Power-On Reset

The LTC2609/LTC2619/LTC2629 clear the outputs to zero-scale when power is first applied, making system initialization consistent and repeatable. The LTC2609-1/LTC2619-1/LTC2629-1 set the voltage outputs to mid-scale when power is first applied.

For some applications, downstream circuits are active during DAC power-up and may be sensitive to nonzero outputs from the DAC during this time. The LTC2609/LTC2619/LTC2629 contain circuitry to reduce the power-on glitch; furthermore, the glitch amplitude can be made arbitrarily small by reducing the ramp rate of the power supply. For example, if the power supply is ramped to 5V in 1ms, the analog outputs rise less than 10mV above ground (typ) during power-on. See Power-On Reset Glitch in the Typical Performance Characteristics section.

### Power Supply Sequencing

The voltage at REF<sub>x</sub> (Pins 3, 6, 12 and 15) should be kept within the range  $-0.3V \leq \text{REF}_x \leq V_{CC} + 0.3V$  (see Absolute Maximum Ratings). Particular care should be taken to observe these limits during power supply turn-on and turn-off sequences, when the voltage at V<sub>CC</sub> (Pin 16) is in transition. The REF<sub>x</sub> pins can be clamped to stay below the maximum voltage by using Schottky diodes as shown in Figure 2, thereby easing sequencing constraints.

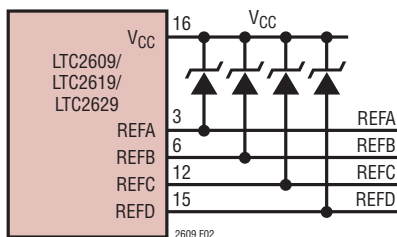

Figure 2. Use of Schottky Diodes for Power Supply Sequencing

### Transfer Function

The digital-to-analog transfer function is:

$$V_{\text{OUT(IDEAL)}} = \left( \frac{k}{2^N} \right) [\text{REF}_x - \text{REFLO}] + \text{REFLO}$$

where k is the decimal equivalent of the binary DAC input code, N is the resolution and REF<sub>x</sub> is the voltage at REF<sub>A</sub>, REF<sub>B</sub>, REF<sub>C</sub> and REF<sub>D</sub> (Pins 3, 6, 12 and 15).

### Serial Digital Interface

The LTC2609/LTC2619/LTC2629 communicate with a host using the standard 2-wire I<sup>2</sup>C interface. The Timing Diagram (Figure 1) shows the timing relationship of the signals on the bus. The two bus lines, SDA and SCL, must be high when the bus is not in use. External pull-up resistors or current sources are required on these lines. The value of these pull-up resistors is dependent on the power supply and can be obtained from the I<sup>2</sup>C specifications. For an I<sup>2</sup>C bus operating in the fast mode, an active pull-up will be necessary if the bus capacitance is greater than 200pF. The V<sub>CC</sub> power should not be removed from the LTC2609/LTC2619/LTC2629 when the I<sup>2</sup>C bus is active to avoid loading the I<sup>2</sup>C bus lines through the internal ESD protection diodes.

The LTC2609/LTC2619/LTC2629 are receive-only (slave) devices. The master can write to the LTC2609/LTC2619/LTC2629. The LTC2609/LTC2619/LTC2629 do not respond to a read from the master.

### The START (S) and STOP (P) Conditions

When the bus is not in use, both SCL and SDA must be high. A bus master signals the beginning of a communication to a slave device by transmitting a START condition. A START condition is generated by transitioning SDA from high to low while SCL is high.

When the master has finished communicating with the slave, it issues a STOP condition. A STOP condition is generated by transitioning SDA from low to high while SCL is high. The bus is then free for communication with another I<sup>2</sup>C device.

### Acknowledge

The Acknowledge signal is used for handshaking between the master and the slave. An Acknowledge (active LOW) generated by the slave lets the master know that the latest byte of information was received. The Acknowledge related clock pulse is generated by the master. The master releases the SDA line (HIGH) during the Acknowledge clock pulse. The slave-receiver must pull down the SDA bus line

## OPERATION

during the Acknowledge clock pulse so that it remains a stable LOW during the HIGH period of this clock pulse. The LTC2609/LTC2619/LTC2629 respond to a write by a master in this manner. The LTC2609/LTC2619/LTC2629 do not acknowledge a read (retains SDA HIGH during the period of the Acknowledge clock pulse).

### Chip Address

The state of CA0, CA1 and CA2 decides the slave address of the part. The pins CA0, CA1 and CA2 can be each set to any one of three states:  $V_{CC}$ , GND or float. This results in 27 selectable addresses for the part. The slave address assignments are shown in Table 1.

**Table 1. Slave Address Map**

CA2	CA1	CA0	SA6	SA5	SA4	SA3	SA2	SA1	SA0
GND	GND	GND	0	0	1	0	0	0	0
GND	GND	FLOAT	0	0	1	0	0	0	1
GND	GND	$V_{CC}$	0	0	1	0	0	1	0
GND	FLOAT	GND	0	0	1	0	0	1	1
GND	FLOAT	FLOAT	0	1	0	0	0	0	0
GND	FLOAT	$V_{CC}$	0	1	0	0	0	0	1
GND	$V_{CC}$	GND	0	1	0	0	0	1	0
GND	$V_{CC}$	FLOAT	0	1	0	0	0	1	1
GND	$V_{CC}$	$V_{CC}$	0	1	1	0	0	0	0
FLOAT	GND	GND	0	1	1	0	0	0	1
FLOAT	GND	FLOAT	0	1	1	0	0	1	0
FLOAT	GND	$V_{CC}$	0	1	1	0	0	1	1
FLOAT	FLOAT	GND	1	0	0	0	0	0	0
FLOAT	FLOAT	FLOAT	1	0	0	0	0	0	1
FLOAT	FLOAT	$V_{CC}$	1	0	0	0	0	1	0
FLOAT	$V_{CC}$	GND	1	0	0	0	0	1	1
FLOAT	$V_{CC}$	FLOAT	1	0	1	0	0	0	0
FLOAT	$V_{CC}$	$V_{CC}$	1	0	1	0	0	0	1
$V_{CC}$	GND	GND	1	0	1	0	0	1	0
$V_{CC}$	GND	FLOAT	1	0	1	0	0	1	1
$V_{CC}$	GND	$V_{CC}$	1	1	0	0	0	0	0
$V_{CC}$	FLOAT	GND	1	1	0	0	0	0	1
$V_{CC}$	FLOAT	FLOAT	1	1	0	0	0	1	0
$V_{CC}$	FLOAT	$V_{CC}$	1	1	0	0	0	1	1
$V_{CC}$	$V_{CC}$	GND	1	1	1	0	0	0	0
$V_{CC}$	$V_{CC}$	FLOAT	1	1	1	0	0	0	1
$V_{CC}$	$V_{CC}$	$V_{CC}$	1	1	1	0	0	1	0
GLOBAL ADDRESS			1	1	1	0	0	1	1

In addition to the address selected by the address pins, the parts also respond to a global address. This address allows a common write to all LTC2609, LTC2619 and LTC2629 parts to be accomplished with one 3-byte write transaction on the I<sup>2</sup>C bus. The global address is a 7-bit on-chip hardwired address and is not selectable by CA0, CA1 and CA2.

The addresses corresponding to the states of CA0, CA1 and CA2 and the global address are shown in Table 1. The maximum capacitive load allowed on the address pins (CA0, CA1 and CA2) is 10pF, as these pins are driven during address detection to determine if they are floating.

### Write Word Protocol

The master initiates communication with the LTC2609/LTC2619/LTC2629 with a START condition and a 7-bit slave address followed by the Write bit (W) = 0. The LTC2609/LTC2619/LTC2629 acknowledges by pulling the SDA pin low at the 9th clock if the 7-bit slave address matches the address of the parts (set by CA0, CA1 and CA2) or the global address. The master then transmits three bytes of data. The LTC2609/LTC2619/LTC2629 acknowledges each byte of data by pulling the SDA line low at the 9th clock of each data byte transmission. After receiving three complete bytes of data, the LTC2609/LTC2619/LTC2629 executes the command specified in the 24-bit input word.

If more than three data bytes are transmitted after a valid 7-bit slave address, the LTC2609/LTC2619/LTC2629 do not acknowledge the extra bytes of data (SDA is high during the 9th clock).

The format of the three data bytes is shown in Figure 3. The first byte of the input word consists of the 4-bit command and 4-bit DAC address. The next two bytes consist of the 16-bit data word. The 16-bit data word consists of the 16-, 14- or 12-bit input code, MSB to LSB, followed by 0, 2 or 4 don't care bits (LTC2609, LTC2619 and LTC2629 respectively). A typical LTC2609 write transaction is shown in Figure 4.

The command (C3-C0) and address (A3-A0) assignments are shown in Table 2. The first four commands in the table consist of write and update operations. A write operation

## OPERATION

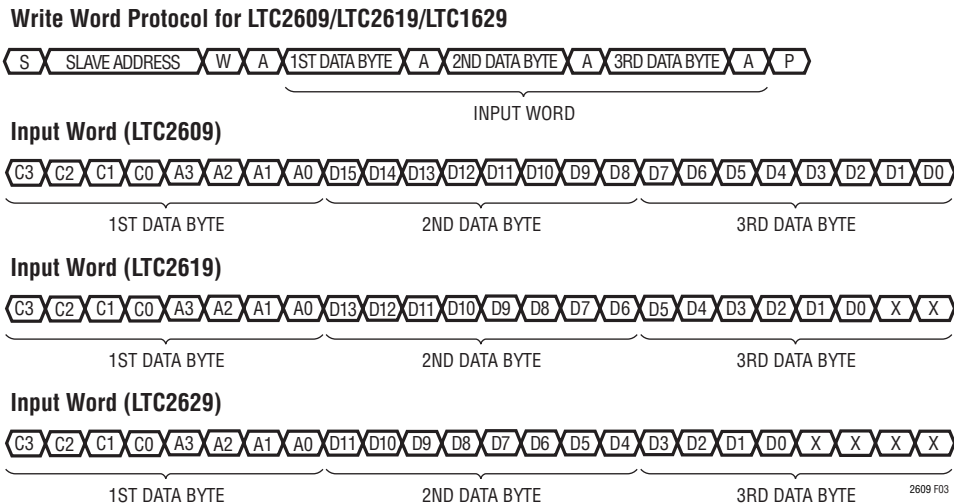

Figure 3

Table 2

COMMAND*				
C3	C2	C1	C0	
0	0	0	0	Write to Input Register n
0	0	0	1	Update (Power Up) DAC Register n
0	0	1	0	Write to Input Register n, Update (Power Up) All n
0	0	1	1	Write to and Update (Power Up) n
0	1	0	0	Power Down n
1	1	1	1	No Operation
ADDRESS (n)*				
A3	A2	A1	A0	
0	0	0	0	DAC A
0	0	0	1	DAC B
0	0	1	0	DAC C
0	0	1	1	DAC D
1	1	1	1	All DACs

\*Command and address codes not shown are reserved and should not be used.

loads a 16-bit data word from the 32-bit shift register into the input register of the selected DAC, n. An update operation copies the data word from the input register to the DAC register. Once copied into the DAC register, the data word becomes the active 16-, 14- or 12-bit input code, and is converted to an analog voltage at the DAC output. The update operation also powers up the selected DAC if it had been in power-down mode. The data path and registers are shown in the Block Diagram.

### Power-Down Mode

For power-constrained applications, power-down mode can be used to reduce the supply current whenever less than four outputs are needed. When in power-down, the buffer amplifiers, bias circuits and reference inputs are disabled, and draw essentially zero current. The DAC outputs are put into a high impedance state, and the output pins are passively pulled to REFLO through individual 90k resistors. Input- and DAC-register contents are not disturbed during power down.

Any channel or combination of channels can be put into power-down mode by using command 0100b in combination with the appropriate DAC address, (n). The 16-bit data word is ignored. The supply current is reduced by approximately 1/4 for each DAC powered down. The effective resistance at REF<sub>x</sub> (Pins 3, 6, 12 and 15) are at high impedance (typically > 1GΩ) when the corresponding DACs are powered down. Normal operation can be resumed by executing any command which includes a DAC update, as shown in Table 2.

The selected DAC is powered up as its voltage output is updated. When a DAC which is in a powered-down state is powered up and updated, normal settling is delayed. If less than four DACs are in a powered-down state prior to the update command, the power-up delay time is 5μs. If on the other hand, all four DACs are powered down, then the



## OPERATION

main bias generation circuit block has been automatically shut down in addition to the individual DAC amplifiers and reference inputs. In this case, the power-up delay time is  $12\mu\text{s}$  (for  $V_{CC} = 5\text{V}$ ) or  $30\mu\text{s}$  (for  $V_{CC} = 3\text{V}$ ).

### Voltage Output

The rail-to-rail amplifier has guaranteed load regulation when sourcing or sinking up to 15mA at 5V (7.5mA at 2.7V).

Load regulation is a measure of the amplifier's ability to maintain the rated voltage accuracy over a wide range of load conditions. The measured change in output voltage per milliampere of forced load current change is expressed in LSB/mA.

DC output impedance is equivalent to load regulation, and may be derived from it by simply calculating a change in units from LSB/mA to Ohms. The amplifier's DC output impedance is  $0.035\Omega$  when driving a load well away from the rails.

When drawing a load current from either rail, the output voltage headroom with respect to that rail is limited by the  $30\Omega$  typical channel resistance of the output devices; e.g., when sinking 1mA, the minimum output voltage =  $30\Omega \cdot 1\text{mA} = 30\text{mV}$ . See the graph Headroom at Rails vs Output Current in the Typical Performance Characteristics section.

The amplifier is stable driving capacitive loads of up to 1000pF.

### Board Layout

The excellent load regulation and DC crosstalk performance of these devices is achieved in part by keeping "signal" and "power" grounds separate.

The PC board should have separate areas for the analog and digital sections of the circuit. This keeps digital signals away from sensitive analog signals and facilitates the use of separate digital and analog ground planes which have minimal capacitive and resistive interaction with each other.

Digital and analog ground planes should be joined at only one point, establishing a system star ground as close to the device's ground pin as possible. Ideally, the analog ground plane should be located on the component side of the board, and should be allowed to run under the part to shield it from noise. Analog ground should be a continuous and uninterrupted plane, except for necessary lead pads and vias, with signal traces on another layer.

The GND pin functions as a return path for power supply currents in the device and should be connected to analog ground. Resistance from the GND pin to system star ground should be as low as possible. When a zero-scale DAC output voltage of zero is desired, REFLO (Pin 2) should be connected to system star ground.

### Rail-to-Rail Output Considerations

In any rail-to-rail voltage output device, the output is limited to voltages within the supply range.

Since the analog output of the device cannot go below ground, it may limit for the lowest codes as shown in Figure 4b. Similarly, limiting can occur near full-scale when the REF pins are tied to  $V_{CC}$ . If  $\text{REF}_x = V_{CC}$  and the DAC full-scale error (FSE) is positive, the output for the highest codes limits at  $V_{CC}$  as shown in Figure 4c. No full-scale limiting can occur if  $\text{REF}_x$  is less than  $V_{CC} - \text{FSE}$ .

Offset and linearity are defined and tested over the region of the DAC transfer function where no output limiting can occur.

OPERATION

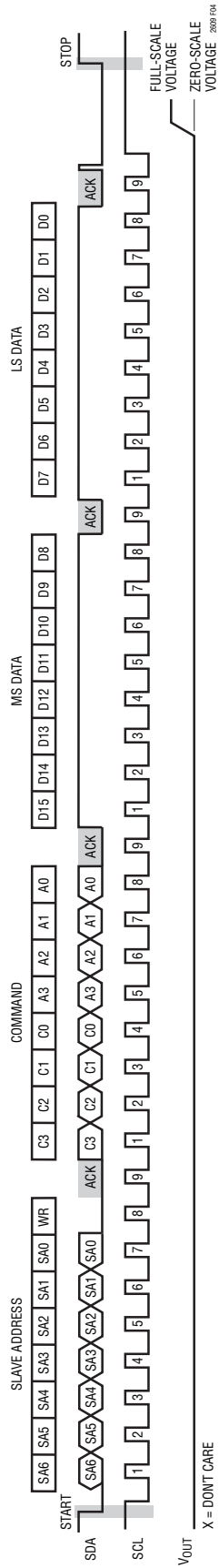

Figure 4. Typical LTC2609 Input Waveform—Programming DAC Output for Full-Scale

OPERATION

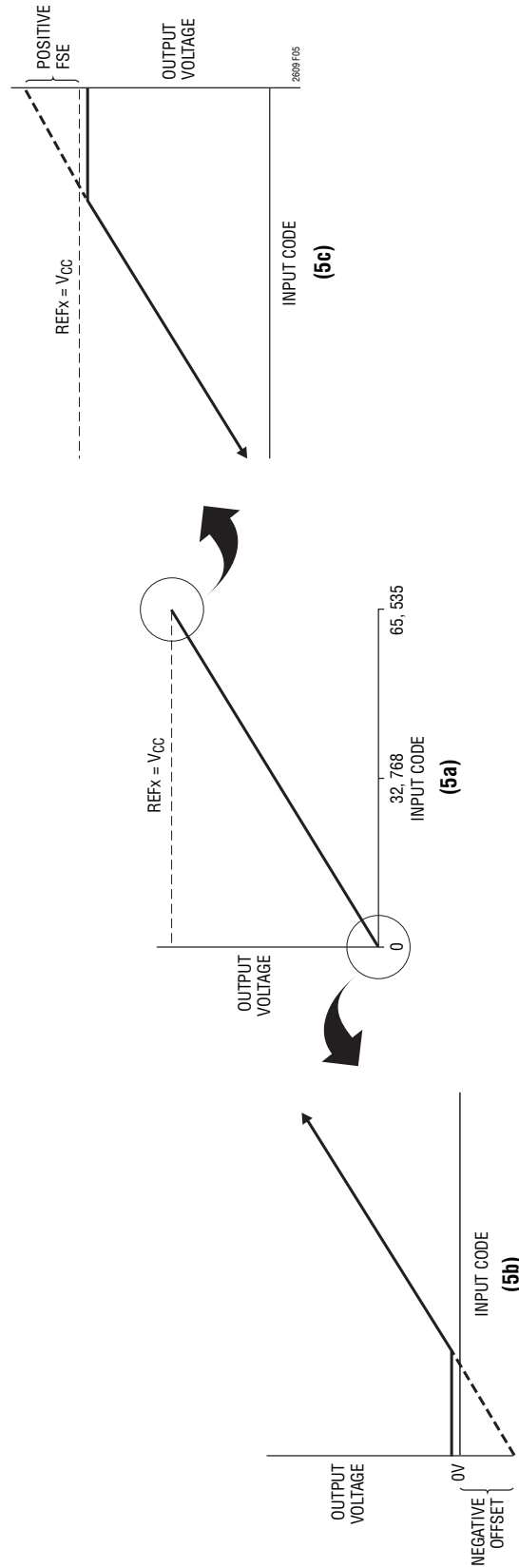
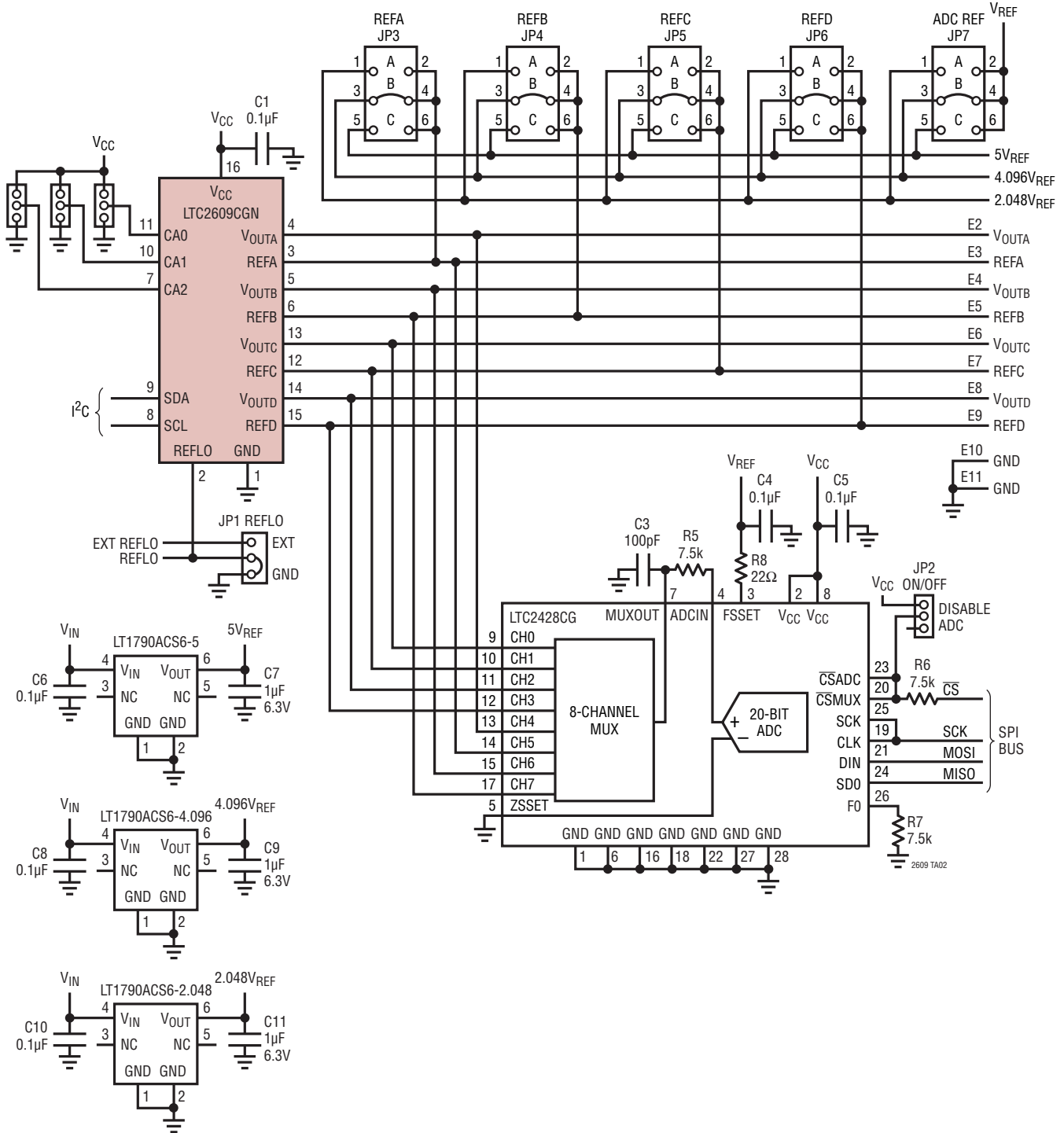

Figure 5. Effects of Rail-to-Rail Operation on a DAC Transfer Curve. (5a) Overall Transfer Function, (5b) Effect of Negative Offset for Codes Near Zero-Scale, (5c) Effect of Positive Full-Scale Error for Codes Near Full-Scale

## TYPICAL APPLICATION

Demo Board Schematic—Onboard 20-Bit ADC Measures Key Performance Parameters



## REVISION HISTORY

REV	DATE	DESCRIPTION	PAGE NUMBER
A	11/09	Update Manufacturer's Information on Typical Application	1
		Revise Receiver Input Hysteresis Conditions	3
		Revise Block Diagram	7
		Revise Figure 1.	8
		Update Manufacturer's Information on Figure 10	10
		Update Tables 1 and 3	12
B	3/10	Revised C- and I-Grade Temperature Ranges in Order Information Section	2

# LTC2609/LTC2619/LTC2629

## PACKAGE DESCRIPTION

**GN Package**  
**16-Lead Plastic SSOP**  
 (Reference LTC DWG # 05-08-1641)

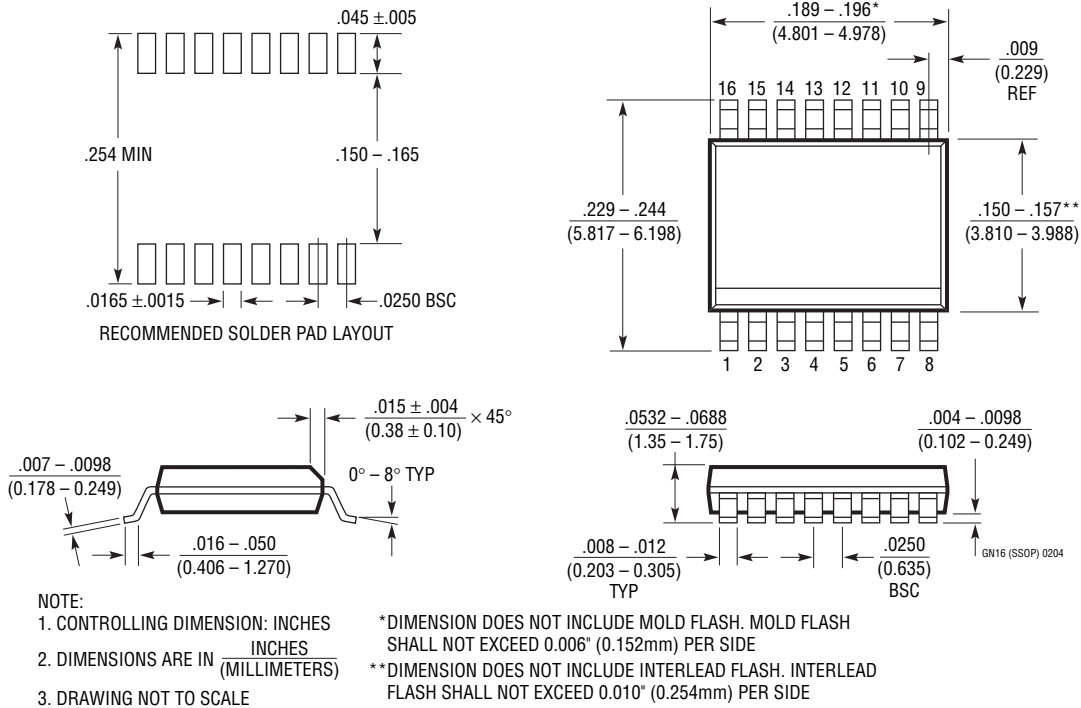

## RELATED PARTS

PART NUMBER	DESCRIPTION	COMMENTS
LTC1458/LTC1458L	Quad 12-Bit Rail-to-Rail Output DACs with Added Functionality	LTC1458: $V_{CC} = 4.5V$ to $5.5V$ , $V_{OUT} = 0V$ to $4.096V$ LTC1458L: $V_{CC} = 2.7V$ to $5.5V$ , $V_{OUT} = 0V$ to $2.5V$
LTC1654	Dual 14-Bit Rail-to-Rail $V_{OUT}$ DAC	Programmable Speed/Power, $3.5\mu s/750\mu A$ , $8\mu s/450\mu A$
LTC1655/LTC1655L	Single 16-Bit $V_{OUT}$ DACs with Serial Interface in SO-8	$V_{CC} = 5V(3V)$ , Low Power, Deglitched
LTC1657/LTC1657L	Parallel 5V/3V 16-Bit $V_{OUT}$ DACs	Low Power, Deglitched, Rail-to-Rail $V_{OUT}$
LTC1660/LTC1665	Octal 10/8-Bit $V_{OUT}$ DACs in 16-Pin Narrow SSOP	$V_{CC} = 2.7V$ to $5.5V$ , Micropower, Rail-to-Rail Output
LTC1821	Parallel 16-Bit Voltage Output DAC	Precision 16-Bit Settling in $2\mu s$ for 10V Step
LTC2600/LTC2610 LTC2620	Octal 16-/14-/12-Bit $V_{OUT}$ DACs in 16-Lead SSOP	$250\mu A$ per DAC, $2.5V$ to $5.5V$ Supply Range, Rail-to-Rail Output, SPI Serial Interface
LTC2601/LTC2611 LTC2621	Single 16-/14-/12-Bit $V_{OUT}$ DACs in 10-Lead DFN	$250\mu A$ per DAC, $2.5V$ to $5.5V$ Supply Range, Rail-to-Rail Output, SPI Serial Interface
LTC2602/LTC2612 LTC2622	Dual 16-/14-/12-Bit $V_{OUT}$ DACs in 8-Lead MSOP	$300\mu A$ per DAC, $2.5V$ to $5.5V$ Supply Range, Rail-to-Rail Output, SPI Serial Interface
LTC2604/LTC2614 LTC2624	Quad 16-/14-/12-Bit $V_{OUT}$ DACs in 16-Lead SSOP	$250\mu A$ per DAC, $2.5V$ to $5.5V$ Supply Range, Rail-to-Rail Output, SPI Serial Interface
LTC2605/LTC2615 LTC2625	Octal 16-/14-/12-Bit $V_{OUT}$ DACs with $I^2C$ Interface in 16-Lead SSOP	$250\mu A$ per DAC, $2.7V$ to $5.5V$ Supply Range, Rail-to-Rail Output
LTC2606/LTC2616 LTC2626	Single 16-/14-/12-Bit $V_{OUT}$ DACs in 10-Lead DFN with $I^2C$ Interface	$270\mu A$ per DAC, $2.7V$ to $5.5V$ Supply Range, Rail-to-Rail Output

26091929fb



**Стандарт  
Электрон  
Связь**

Мы молодая и активно развивающаяся компания в области поставок электронных компонентов. Мы поставляем электронные компоненты отечественного и импортного производства напрямую от производителей и с крупнейших складов мира.

Благодаря сотрудничеству с мировыми поставщиками мы осуществляем комплексные и плановые поставки широчайшего спектра электронных компонентов.

Собственная эффективная логистика и склад в обеспечивает надежную поставку продукции в точно указанные сроки по всей России.

Мы осуществляем техническую поддержку нашим клиентам и предпродажную проверку качества продукции. На все поставляемые продукты мы предоставляем гарантию .

Осуществляем поставки продукции под контролем ВП МО РФ на предприятия военно-промышленного комплекса России , а также работаем в рамках 275 ФЗ с открытием отдельных счетов в уполномоченном банке. Система менеджмента качества компании соответствует требованиям ГОСТ ISO 9001.

Минимальные сроки поставки, гибкие цены, неограниченный ассортимент и индивидуальный подход к клиентам являются основой для выстраивания долгосрочного и эффективного сотрудничества с предприятиями радиоэлектронной промышленности, предприятиями ВПК и научно-исследовательскими институтами России.

С нами вы становитесь еще успешнее!

**Наши контакты:**

**Телефон:** +7 812 627 14 35

**Электронная почта:** [sales@st-electron.ru](mailto:sales@st-electron.ru)

**Адрес:** 198099, Санкт-Петербург,  
Промышленная ул, дом № 19, литера Н,  
помещение 100-Н Офис 331