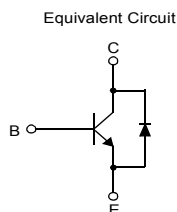
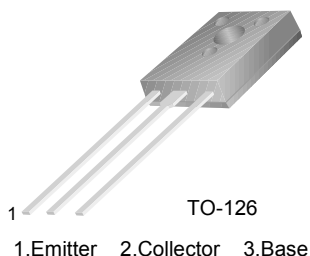


# FJE5304D

## NPN Triple Diffused Planar Silicon Transistor

### High Voltage High Speed Power Switch Application

- Wide Safe Operating Area
- Built-in Free Wheeling diode
- Suitable for Electronic Ballast Application
- Small Variance in Storage Time



### Absolute Maximum Ratings $T_C = 25^\circ\text{C}$ unless otherwise noted

Symbol	Parameter	Value	Units
$V_{CBO}$	Collector-Base Voltage	700	V
$V_{CEO}$	Collector-Emitter Voltage	400	V
$V_{EBO}$	Emitter-Base Voltage	12	V
$I_C$	Collector Current (DC)	4	A
$I_{CP}$	* Collector Current (Pulse)	8	A
$I_B$	Base Current (DC)	2	A
$I_{BP}$	* Base Current (Pulse)	4	A
$P_C$	Collector Dissipation ( $T_C=25^\circ\text{C}$ )	30	W
$T_{STG}$	Storage Temperature	- 65 ~ 150	$^\circ\text{C}$

\* Pulse Test Pulse Width = 5ms, Duty Cycle  $\geq 1.0\%$

### Electrical Characteristics $T_C = 25^\circ\text{C}$ unless otherwise noted

Symbol	Parameter	Test Condition	Min.	Typ.	Max.	Units
$BV_{CBO}$	Collector-Base Breakdown Voltage	$I_C = 1\text{mA}, I_E = 0$	700			V
$BV_{CEO}$	Collector-Emitter Breakdown Voltage	$I_C = 5\text{mA}, I_B = 0$	400			V
$BV_{EBO}$	Emitter-Base Breakdown Voltage	$I_E = 1\text{mA}, I_C = 0$	12			V
$I_{CES}$	Collector Cut-off Current	$V_{CE} = 700\text{V}, V_{EB} = 0$			100	$\mu\text{A}$
$I_{CEO}$	Collector Cut-off Current	$V_{CE} = 400\text{V}, I_B = 0$			250	$\mu\text{A}$
$I_{EBO}$	Emitter Cut-off Current	$V_{EB} = 12\text{V}, I_C = 0$			100	$\mu\text{A}$
$h_{FE}$	DC Current Gain	$V_{CE} = 5\text{V}, I_C = 10\text{mA}$ $V_{CE} = 5\text{V}, I_C = 2\text{A}$	10 8		40	

**Electrical Characteristics** (Continued)  $T_C = 25^\circ\text{C}$  unless otherwise noted

Symbol	Parameter	Test Condition	Min.	Typ.	Max.	Units
$V_{CE(sat)}$	Collector-Emitter Saturation Voltage	$I_C = 0.5\text{A}, I_B = 0.1\text{A}$ $I_C = 1\text{A}, I_B = 0.2\text{A}$ $I_C = 2.5\text{A}, I_B = 0.5\text{A}$			0.7 1.0 1.5	V
$V_{BE(sat)}$	Base-Emitter Saturation Voltage	$I_C = 0.5\text{A}, I_B = 0.1\text{A}$ $I_C = 1\text{A}, I_B = 0.2\text{A}$ $I_C = 2.5\text{A}, I_B = 0.5\text{A}$			1.1 1.2 1.3	V
$V_f$	Internal Diode Forward Voltage Drop	$I_F = 2\text{A}$			2.5	V
<b>Inductive Load Switching (<math>V_{CC} = 200\text{V}</math>)</b>						
$t_{stg}$	Storage Time	$I_C = 2\text{A}, I_{B1} = 0.4\text{A}$ $V_{BE(off)} = -5\text{V}$ $L = 200\mu\text{H}$		0.6		$\mu\text{s}$
$t_f$	Fall Time			0.1		
<b>Resistive Load Switching (<math>V_{CC} = 250\text{V}</math>)</b>						
$t_{stg}$	Storage Time	$I_C = 2\text{A}, I_{B1} = I_{B2} = 0.4\text{A}$ $T_P = 30\mu\text{s}$			2.9	$\mu\text{s}$
$t_f$	Fall Time			0.2		

\* Pulse test:  $PW \leq 300\mu\text{s}$ , Duty cycle  $\leq 2\%$

**Thermal Characteristics**  $T_C = 25^\circ\text{C}$  unless otherwise noted

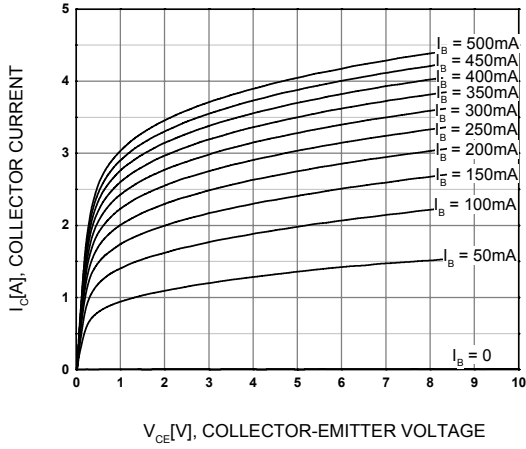
Symbol	Parameter	Max.	Units
$R_{\theta JC}$	Thermal Resistance, Junction to Case	4.17	$^\circ\text{C/W}$
$R_{\theta JA}$	Thermal Resistance, Junction to Ambient	83.3	$^\circ\text{C/W}$

**Package Marking and Ordering Information**

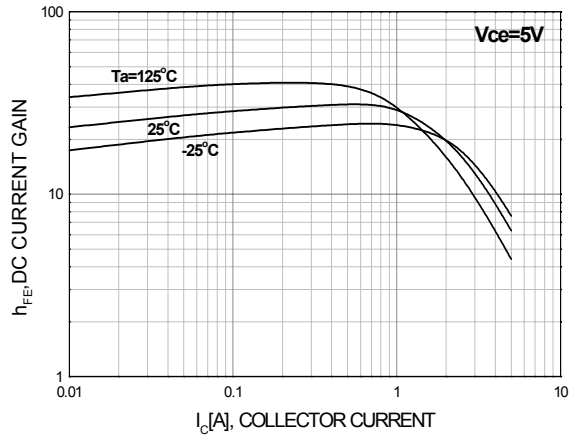
Device Marking	Device	Package	Reel Size	Tape Width	Quantity
FJE5304D	FJE5304D	TO-126	--	--	--

## Typical Performance Characteristics

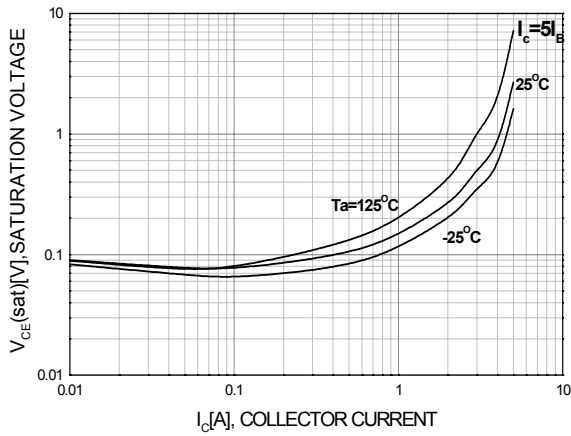
**Figure 1. Static Characteristic**



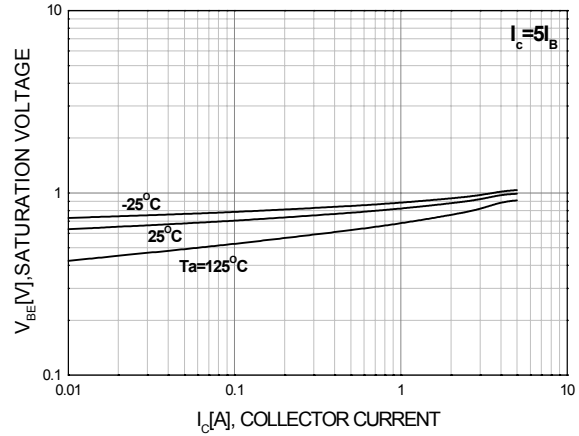
**Figure 2. DC Current Gain**



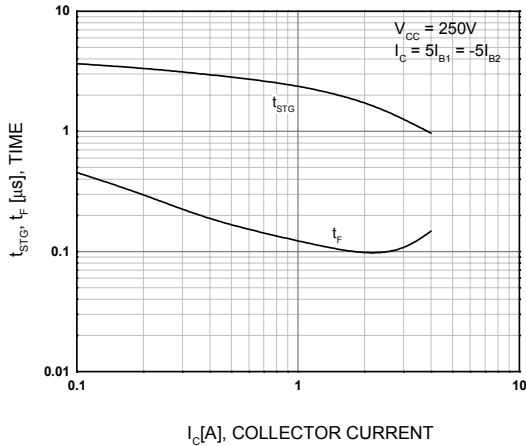
**Figure 3. Collector-Emitter Saturation Voltage**



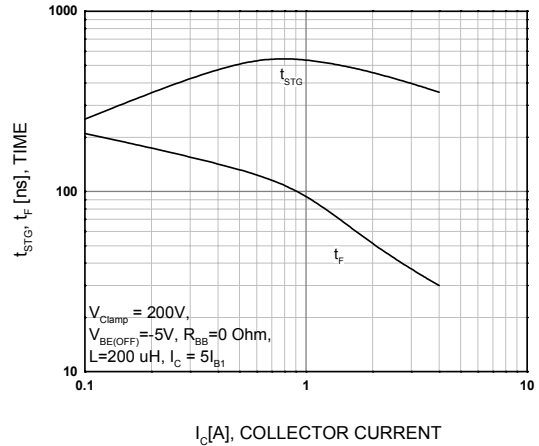
**Figure 4. Base-Emitter Saturation Voltage**



**Figure 5. Resistive Load Switching Time**

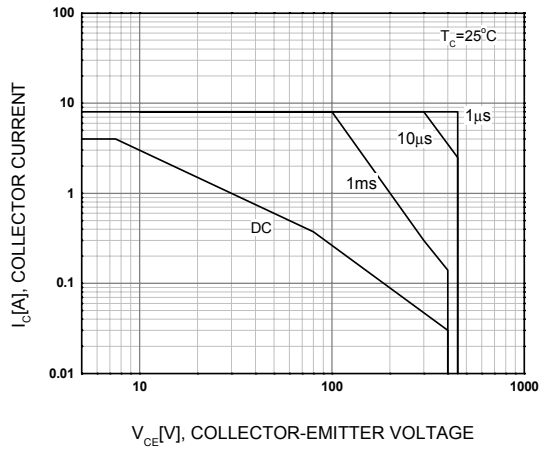


**Figure 6. Inductive Load Switching Time**

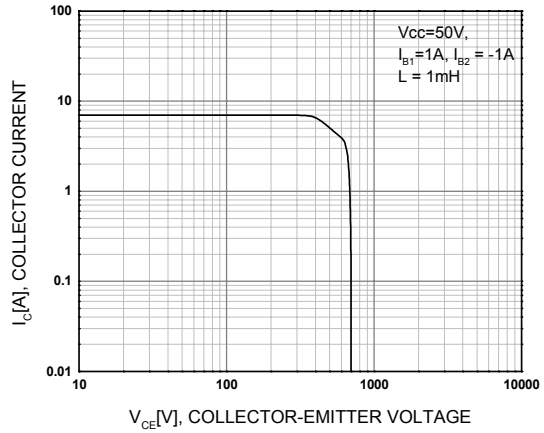


## Typical Performance Characteristics

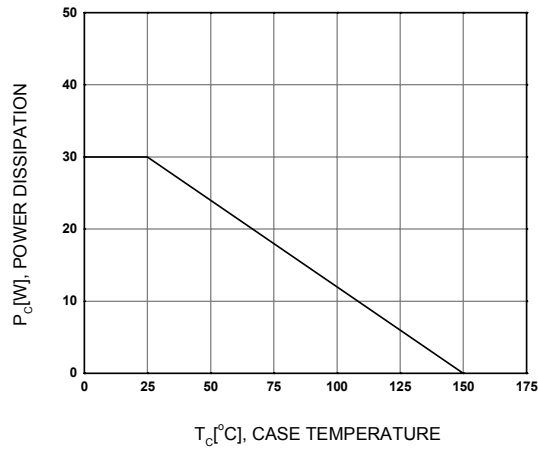
**Figure 7. Forward Bias Safe Operating Area**



**Figure 8. Reverse Bias Safe Operating Area**

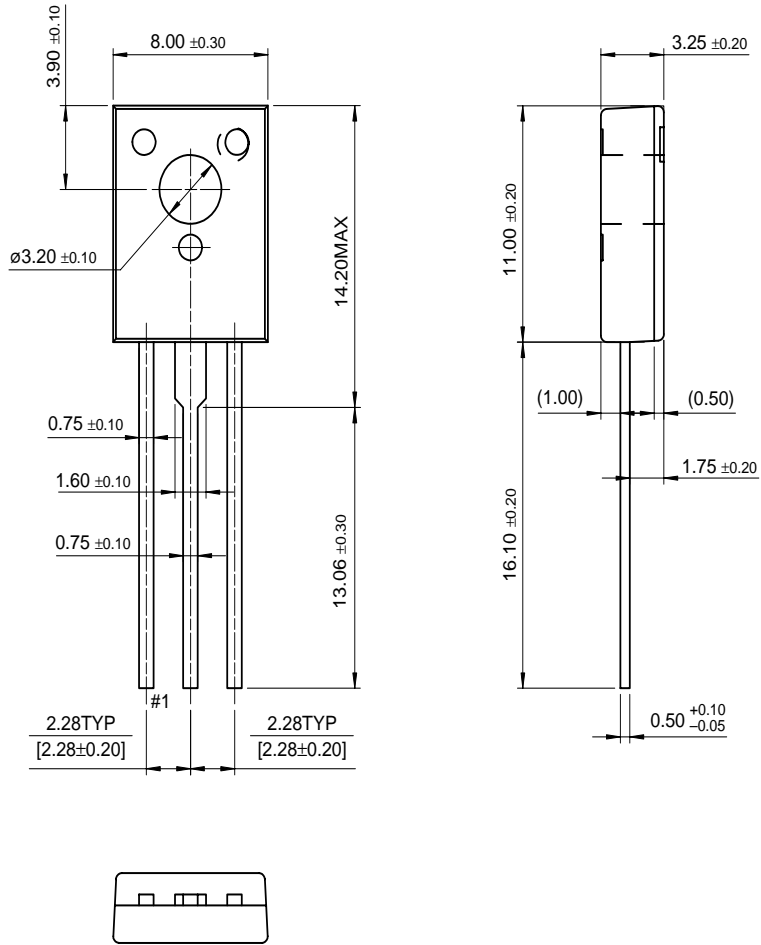


**Figure 9. Power Derating**



**Mechanical Dimensions**

**TO-126**



Dimensions in Millimeters

**TRADEMARKS**

The following are registered and unregistered trademarks Fairchild Semiconductor owns or is authorized to use and is not intended to be an exhaustive list of all such trademarks.

ACEx™	FAST®	ISOPLANAR™	PowerSaver™	SuperSOT™-8
ActiveArray™	FASTR™	LittleFET™	PowerTrench®	SyncFET™
Bottomless™	FPS™	MICROCOUPLER™	QFET®	TinyLogic®
Build it Now™	FRFET™	MicroFET™	QS™	TINYOPTO™
CoolFET™	GlobalOptoisolator™	MicroPak™	QT Optoelectronics™	TruTranslation™
CROSSVOLT™	GTO™	MICROWIRE™	Quiet Series™	UHC™
DOME™	HiSeC™	MSX™	RapidConfigure™	UltraFET®
EcoSPARK™	I <sup>2</sup> C™	MSXPro™	RapidConnect™	UniFET™
E <sup>2</sup> CMOS™	i-Lo™	OCX™	μSerDes™	VCX™
EnSigna™	ImpliedDisconnect™	OCXPro™	SILENT SWITCHER®	Wire™
FACT™	IntelliMAX™	OPTOLOGIC®	SMART START™	
FACT Quiet Series™		OPTOPLANAR™	SPM™	
Across the board. Around the world.™		PACMAN™	Stealth™	
The Power Franchise®		POP™	SuperFET™	
Programmable Active Droop™		Power247™	SuperSOT™-3	
		PowerEdge™	SuperSOT™-6	

**DISCLAIMER**

FAIRCHILD SEMICONDUCTOR RESERVES THE RIGHT TO MAKE CHANGES WITHOUT FURTHER NOTICE TO ANY PRODUCTS HEREIN TO IMPROVE RELIABILITY, FUNCTION OR DESIGN. FAIRCHILD DOES NOT ASSUME ANY LIABILITY ARISING OUT OF THE APPLICATION OR USE OF ANY PRODUCT OR CIRCUIT DESCRIBED HEREIN; NEITHER DOES IT CONVEY ANY LICENSE UNDER ITS PATENT RIGHTS, NOR THE RIGHTS OF OTHERS.

**LIFE SUPPORT POLICY**

FAIRCHILD'S PRODUCTS ARE NOT AUTHORIZED FOR USE AS CRITICAL COMPONENTS IN LIFE SUPPORT DEVICES OR SYSTEMS WITHOUT THE EXPRESS WRITTEN APPROVAL OF FAIRCHILD SEMICONDUCTOR CORPORATION.

As used herein:

- Life support devices or systems are devices or systems which, (a) are intended for surgical implant into the body, or (b) support or sustain life, or (c) whose failure to perform when properly used in accordance with instructions for use provided in the labeling, can be reasonably expected to result in significant injury to the user.
- A critical component is any component of a life support device or system whose failure to perform can be reasonably expected to cause the failure of the life support device or system, or to affect its safety or effectiveness.

**PRODUCT STATUS DEFINITIONS**

**Definition of Terms**

Datasheet Identification	Product Status	Definition
Advance Information	Formative or In Design	This datasheet contains the design specifications for product development. Specifications may change in any manner without notice.
Preliminary	First Production	This datasheet contains preliminary data, and supplementary data will be published at a later date. Fairchild Semiconductor reserves the right to make changes at any time without notice in order to improve design.
No Identification Needed	Full Production	This datasheet contains final specifications. Fairchild Semiconductor reserves the right to make changes at any time without notice in order to improve design.
Obsolete	Not In Production	This datasheet contains specifications on a product that has been discontinued by Fairchild semiconductor. The datasheet is printed for reference information only.

Rev. 116



## Стандарт Электрон Связь

Мы молодая и активно развивающаяся компания в области поставок электронных компонентов. Мы поставляем электронные компоненты отечественного и импортного производства напрямую от производителей и с крупнейших складов мира.

Благодаря сотрудничеству с мировыми поставщиками мы осуществляем комплексные и плановые поставки широчайшего спектра электронных компонентов.

Собственная эффективная логистика и склад в обеспечивает надежную поставку продукции в точно указанные сроки по всей России.

Мы осуществляем техническую поддержку нашим клиентам и предпродажную проверку качества продукции. На все поставляемые продукты мы предоставляем гарантию .

Осуществляем поставки продукции под контролем ВП МО РФ на предприятия военно-промышленного комплекса России , а также работаем в рамках 275 ФЗ с открытием отдельных счетов в уполномоченном банке. Система менеджмента качества компании соответствует требованиям ГОСТ ISO 9001.

Минимальные сроки поставки, гибкие цены, неограниченный ассортимент и индивидуальный подход к клиентам являются основой для выстраивания долгосрочного и эффективного сотрудничества с предприятиями радиоэлектронной промышленности, предприятиями ВПК и научно-исследовательскими институтами России.

С нами вы становитесь еще успешнее!

### Наши контакты:

**Телефон:** +7 812 627 14 35

**Электронная почта:** [sales@st-electron.ru](mailto:sales@st-electron.ru)

**Адрес:** 198099, Санкт-Петербург,  
Промышленная ул, дом № 19, литера Н,  
помещение 100-Н Офис 331