



Is Now Part of



ON Semiconductor®

To learn more about ON Semiconductor, please visit our website at
www.onsemi.com

Please note: As part of the Fairchild Semiconductor integration, some of the Fairchild orderable part numbers will need to change in order to meet ON Semiconductor's system requirements. Since the ON Semiconductor product management systems do not have the ability to manage part nomenclature that utilizes an underscore (_), the underscore (_) in the Fairchild part numbers will be changed to a dash (-). This document may contain device numbers with an underscore (_). Please check the ON Semiconductor website to verify the updated device numbers. The most current and up-to-date ordering information can be found at www.onsemi.com. Please email any questions regarding the system integration to Fairchild_questions@onsemi.com.

ON Semiconductor and the ON Semiconductor logo are trademarks of Semiconductor Components Industries, LLC dba ON Semiconductor or its subsidiaries in the United States and/or other countries. ON Semiconductor owns the rights to a number of patents, trademarks, copyrights, trade secrets, and other intellectual property. A listing of ON Semiconductor's product/patent coverage may be accessed at www.onsemi.com/site/pdf/Patent-Marking.pdf. ON Semiconductor reserves the right to make changes without further notice to any products herein. ON Semiconductor makes no warranty, representation or guarantee regarding the suitability of its products for any particular purpose, nor does ON Semiconductor assume any liability arising out of the application or use of any product or circuit, and specifically disclaims any and all liability, including without limitation special, consequential or incidental damages. Buyer is responsible for its products and applications using ON Semiconductor products, including compliance with all laws, regulations and safety requirements or standards, regardless of any support or applications information provided by ON Semiconductor. "Typical" parameters which may be provided in ON Semiconductor data sheets and/or specifications can and do vary in different applications and actual performance may vary over time. All operating parameters, including "Typicals" must be validated for each customer application by customer's technical experts. ON Semiconductor does not convey any license under its patent rights nor the rights of others. ON Semiconductor products are not designed, intended, or authorized for use as a critical component in life support systems or any FDA Class 3 medical devices or medical devices with a same or similar classification in a foreign jurisdiction or any devices intended for implantation in the human body. Should Buyer purchase or use ON Semiconductor products for any such unintended or unauthorized application, Buyer shall indemnify and hold ON Semiconductor and its officers, employees, subsidiaries, affiliates, and distributors harmless against all claims, costs, damages, and expenses, and reasonable attorney fees arising out of, directly or indirectly, any claim of personal injury or death associated with such unintended or unauthorized use, even if such claim alleges that ON Semiconductor was negligent regarding the design or manufacture of the part. ON Semiconductor is an Equal Opportunity/Affirmative Action Employer. This literature is subject to all applicable copyright laws and is not for resale in any manner.



FPF1504 / FPF1504L

Advanced Load Management Switch

Features

- 1.0 V to 3.6 V Input Voltage Operating Range
- Typical $R_{DS(ON)}$:
 - 15 m Ω at $V_{IN}=3.3$ V
 - 20 m Ω at $V_{IN}=1.8$ V
 - 40 m Ω at $V_{IN}=1.0$ V
- Slew Rate Control
- Output Discharge Function
- Low <1 μ A Quiescent Current at $V_{ON}=V_{IN}$
- ESD Protected: 4000 V HBM, 2000 V CDM
- GPIO/CMOS-Compatible Enable Circuitry
- Active HIGH and active LOW versions

Applications

- Mobile Devices and Smart Phones
- Portable Media Devices
- Digital Cameras
- Advanced Notebook, UMPC, and MID
- Portable Medical Devices
- GPS and Navigation Equipment

Description

The FPF1504/FPF1504L are low- R_{DS} P-channel MOSFET load switches of the IntelliMAX™ family. Integrated slew-rate control prevents excessive inrush current from the supply rails with capacitive loads common in power applications. In addition, the FPF1504/FPF1504L feature output discharge capability.

The input voltage range operates from 1.0 V to 3.6 V to fulfill today's mobile device supply requirements. Switch control is by a logic input (ON pin) capable of interfacing directly with low-voltage CMOS control signals and GPIOs in embedded processors.

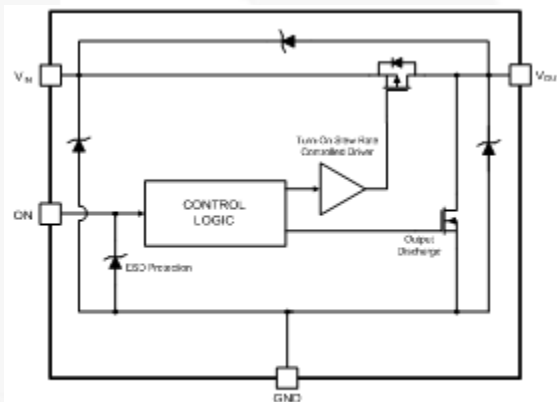

Figure 1. Block Diagram

Ordering Information

Part Number	Top Mark	Switch (Typical) At 1.8 V _{IN}	Input Buffer	Output Discharge	ON Pin Activity	Package
FPF1504UCX	G4	20 m Ω	CMOS	YES	Active HIGH	4-Ball, WLCSP, 0.5 mm Pitch
FPF1504BUCX	G4	20 m Ω	CMOS	YES	Active HIGH	4-Ball, WLCSP with Backside Laminate, 0.5 mm Pitch
FPF1504LUCX	GZ	20 m Ω	CMOS	YES	Active LOW	4-Ball, WLCSP, 0.5 mm Pitch
FPF1504LBUCX	GZ	20 m Ω	CMOS	YES	Active LOW	4-Ball, WLCSP with Backside Laminate, 0.5 mm Pitch

Application Diagram

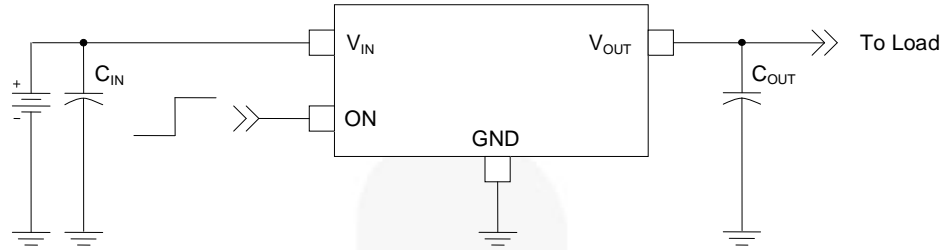

Figure 2. Typical Application

Notes:

1. $C_{IN}=1\ \mu\text{F}$, X5R, 0603, for example Murata GRM185R60J105KE26.
2. $C_{OUT}=1\ \mu\text{F}$, X5R, 0805, for example Murata GRM216R61A105KA01.

Pin Configurations



Figure 3. 1 x 1 mm WLCSP Bumps Facing Down

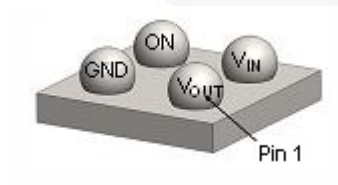

Figure 4. 1 x 1 mm WLCSP Bumps Facing Up

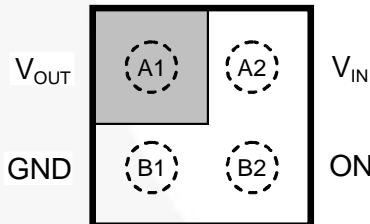

Figure 5. Pin Assignments (Top View)

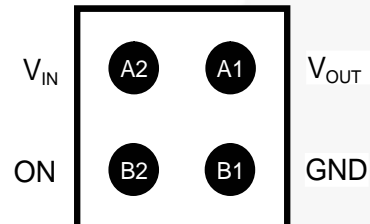

Figure 6. Pin Assignments (Bottom View)

Pin Definitions

Pin #	Name	Description
A1	V_{OUT}	Switch Output
A2	V_{IN}	Supply Input; Input to the Power Switch
B1	GND	Ground
B2	ON	ON/OFF Control

Absolute Maximum Ratings

Stresses exceeding the absolute maximum ratings may damage the device. The device may not function or be operable above the recommended operating conditions and stressing the parts to these levels is not recommended. In addition, extended exposure to stresses above the recommended operating conditions may affect device reliability. The absolute maximum ratings are stress ratings only.

Symbol	Parameter	Min.	Max.	Unit
V_{IN}	V_{IN} , V_{OUT} , V_{ON} to GND	-0.3	4.0	V
I_{SW}	Maximum Continuous Switch Current		1.5	A
P_D	Power Dissipation at $T_A=25^\circ\text{C}$		1.0	W
T_{STG}	Storage Junction Temperature	-65	+150	$^\circ\text{C}$
T_A	Operating Temperature Range	-40	+85	$^\circ\text{C}$
Θ_{JA}	Thermal Resistance, Junction-to-Ambient	1S2P with 1 Thermal Via	95	$^\circ\text{C}/\text{W}$
		1S2P without Thermal Via	187	
ESD	Electrostatic Discharge Capability	Human Body Model, JESD22-A114	4	kV
		Charged Device Model, JESD22-C101	2	

Recommended Operating Conditions

The Recommended Operating Conditions table defines the conditions for actual device operation. Recommended operating conditions are specified to ensure optimal performance to the datasheet specifications. Fairchild does not recommend exceeding them or designing to Absolute Maximum Ratings.

Symbol	Parameter	Min.	Max.	Unit
V_{IN}	Supply Voltage	1.0	3.6	V
T_A	Ambient Operating Temperature	-40	+85	$^\circ\text{C}$

Electrical Characteristics

Unless otherwise noted, $V_{IN}=1.0$ to 3.6 V, $T_A=-40$ to $+85^\circ\text{C}$; typical values are at $V_{IN}=3.3$ V and $T_A=25^\circ\text{C}$.

Symbol	Parameter		Conditions	Min.	Typ.	Max.	Units
Basic Operation							
V_{IN}	Supply Voltage			1.0		3.6	V
$I_{Q(OFF)}$	Off Supply Current	FPF1504	$V_{ON}=GND, V_{OUT}=Open$		0.25		μA
		FPF1504L	$V_{ON}=V_{IN}, V_{OUT}=Open$		0.3		
$I_{SD(OFF)}$	Off Switch Current	FPF1504	$V_{ON}=GND, V_{OUT}=GND$		0.25		
		FPF1504L	$V_{ON}=V_{IN}, V_{OUT}=GND$		0.3		
I_Q	Quiescent Current	FPF1504	$I_{OUT}=0$ mA, $V_{IN}=3.6$ V, $V_{ON}=V_{IN}$		0.08		
			$I_{OUT}=0$ mA, $V_{ON}=V_{IH(MIN)}$		0.75		
		FPF1504L	$I_{OUT}=0$ mA, $V_{IN}=3.6$ V, $V_{ON}=GND$		0.08		
			$I_{OUT}=0$ mA, $V_{ON}=V_{IL(MAX)}$		0.95		
R_{ON}	On Resistance	$V_{IN}=3.3$ V, $I_{OUT}=200$ mA, $T_A=25^\circ\text{C}$			15	30	m Ω
		$V_{IN}=1.8$ V, $I_{OUT}=200$ mA, $T_A=25^\circ\text{C}$			20	40	
		$V_{IN}=1.5$ V, $I_{OUT}=200$ mA, $T_A=25^\circ\text{C}$			30		
		$V_{IN}=1.0$ V, $I_{OUT}=200$ mA, $T_A=25^\circ\text{C}$			40	80	
		$V_{IN}=1.8$ V, $I_{OUT}=200$ mA, $T_A=85^\circ\text{C}^{(3)}$			35	50	
R_{PD}	Output Discharge Pull-Down Resistance		$V_{ON}=0$ V or $V_{IN}, I_{OUT}=-20$ mA		65	95	Ω
V_{IH}	On Input Logic High Voltage	FPF1504		0.8			V
V_{IL}	On Input Logic Low Voltage	FPF1504				0.3	
I_{ON}	On Input Leakage		$V_{ON}=V_{IN}$ or GND			1	μA
Dynamic Characteristics							
t_{DON}	Turn-On Delay ⁽⁴⁾	FPF1504	$R_L=10$ Ω , $C_L=0.1$ μF , $V_{IN}=3.3$ V, $T_A=25^\circ\text{C}$		80		μs
t_R	V_{OUT} Rise Time ⁽⁴⁾	FPF1504			130		
t_{ON}	Turn-On Time ⁽⁴⁾	FPF1504			210		
t_{DON}	Turn-On Delay ⁽⁴⁾	FPF1504	$R_L=500$ Ω , $C_L=0.1$ μF , $V_{IN}=3.3$ V, $T_A=25^\circ\text{C}$		70	100	μs
		FPF1504L			95		
t_R	V_{OUT} Rise Time ⁽⁴⁾	FPF1504			110	150	
		FPF1504L			115		
t_{ON}	Turn-On Time ⁽⁴⁾	FPF1504			180	250	
		FPF1504L			210		

Continued on the following page...

Electrical Characteristics (Continued)

Unless otherwise noted, $V_{IN}=1.0$ to 3.6 V, $T_A=-40$ to $+85^\circ\text{C}$; typical values are at $V_{IN}=3.3$ V and $T_A=25^\circ\text{C}$.

Symbol	Parameter	Conditions	Min.	Typ.	Max.	Units
Dynamic Characteristics (Continued)						
t_{DOFF}	Turn-Off Delay ⁽⁴⁾	FPF1504		25	30	μs
t_F	V_{OUT} Fall Time ⁽⁴⁾	FPF1504	$R_L=10\ \Omega$, $C_L=0.1\ \mu\text{F}$, $V_{IN}=3.3\ \text{V}$, $T_A=25^\circ\text{C}$	2		
t_{OFF}	Turn-Off Time ⁽⁴⁾	FPF1504		27		
t_{DOFF}	Turn-Off Delay ⁽⁴⁾	FPF1504 FPF1504L			25 2	
t_F	V_{OUT} Fall Time ⁽⁴⁾	FPF1504 FPF1504L	$R_L=500\ \Omega$, $C_L=0.1\ \mu\text{F}$, $V_{IN}=3.3\ \text{V}$, $T_A=25^\circ\text{C}$	12 14		
t_{OFF}	Turn-Off Time ⁽⁴⁾	FPF1504 FPF1504L		37 16		

Notes:

3. This parameter is guaranteed by design and characterization; not production tested.
4. $t_{DON}/t_{DOFF}/t_R/t_F$ are defined in Figure 7.
5. Output discharge path is enabled during off.

Timing Diagram – FPF1504

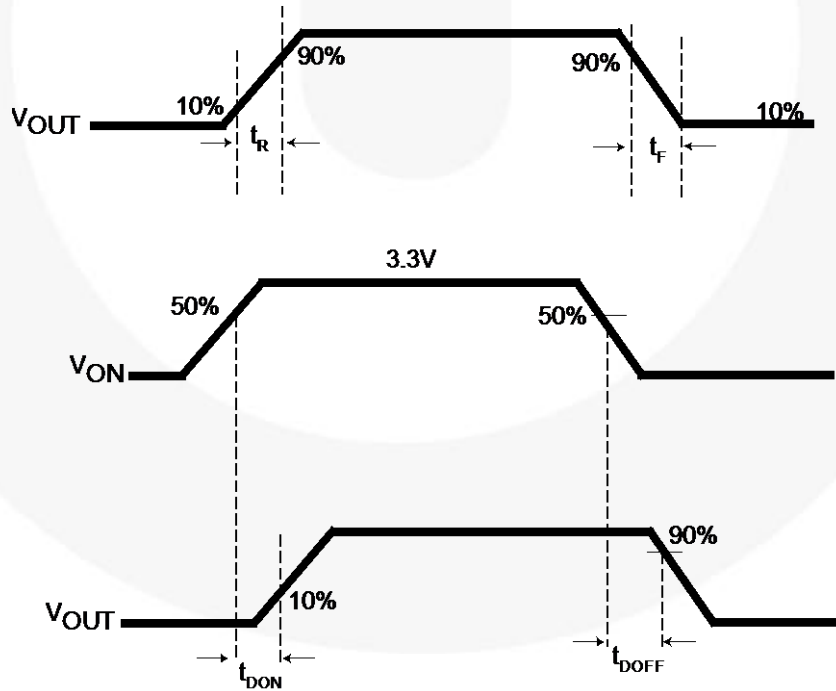

Notes:

6. $t_{ON}=t_R + t_{DON}$.
7. $t_{OFF}=t_F + t_{DOFF}$.

Figure 7. Timing Diagram for FPF1504

Typical Performance Characteristics for FPF1504

Applicable to active high version only.

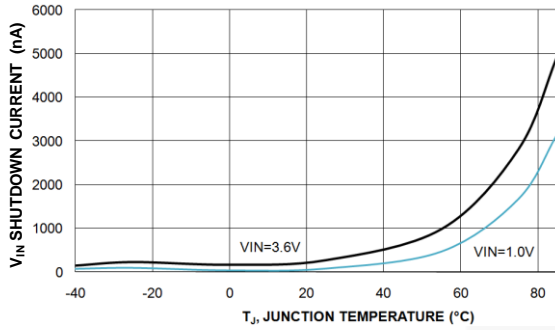

Figure 8. Shutdown Current vs. Temperature

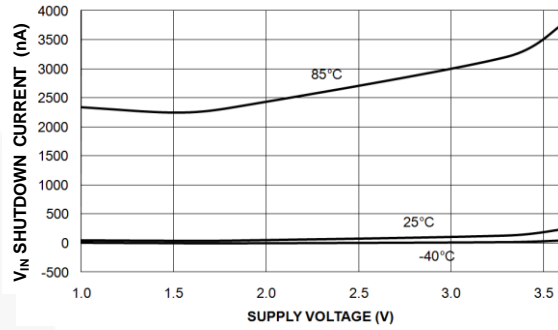

Figure 9. Shutdown Current vs. Supply Voltage

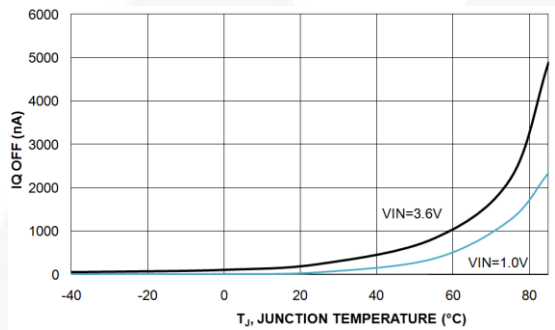

Figure 10. Off Supply Current vs. Temperature

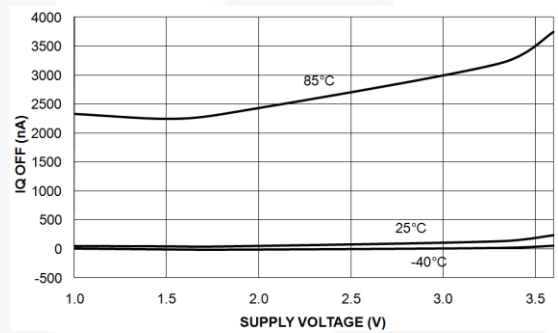

Figure 11. Off Supply Current vs. Supply Voltage

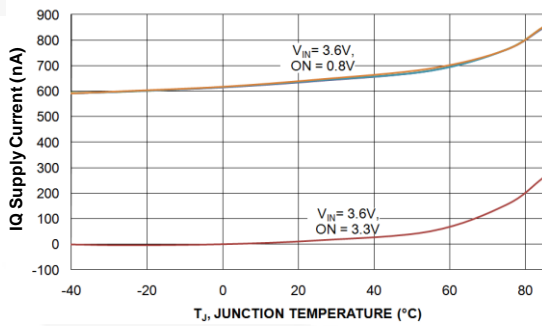

Figure 12. Quiescent Current vs. Temperature

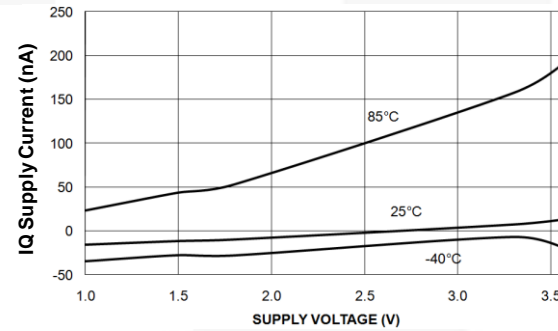

Figure 13. Quiescent Current vs. Supply Voltage (V_{ON}=V_{IN})

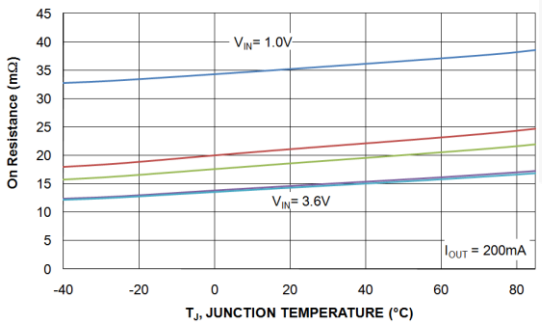

Figure 14. R_{ON} vs. Temperature

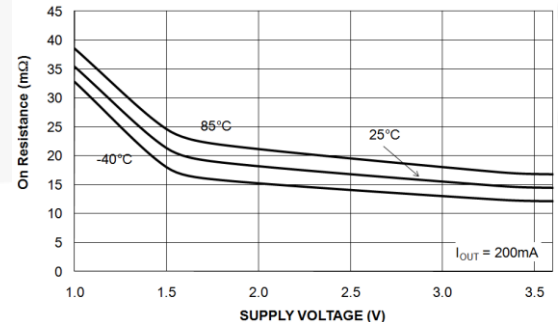

Figure 15. R_{ON} vs. Supply Voltage

Typical Performance Characteristics for FPF1504

Applicable to active high version only.

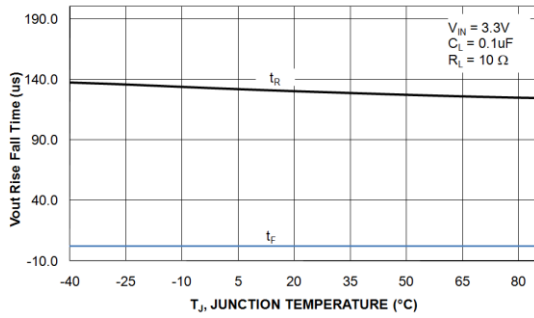

Figure 16. V_{OUT} Rise/Fall Times vs. Temperature ($R_L=10\ \Omega$)

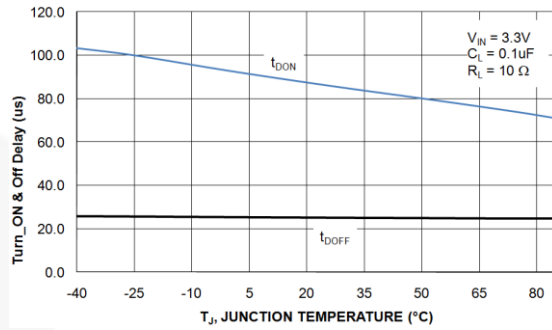

Figure 17. V_{OUT} Turn-On/Turn-Off Delays vs. Temperature ($R_L=10\ \Omega$)

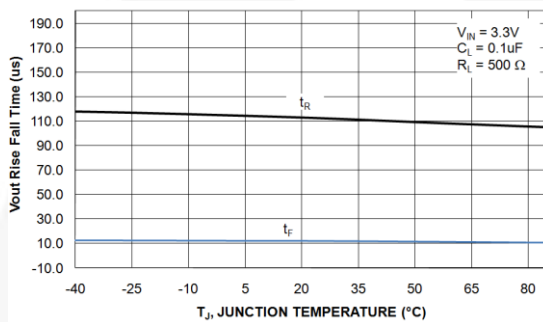

Figure 18. V_{OUT} Rise/Fall Time vs. Temperature ($R_L=500\ \Omega$)

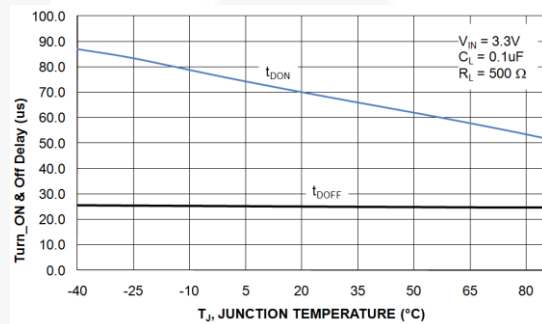

Figure 19. V_{OUT} Turn-On/Turn-Off Delays vs. Temperature ($R_L=500\ \Omega$)

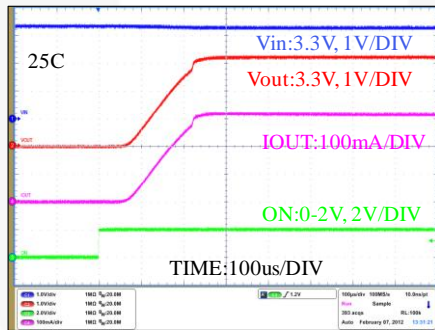

Figure 20. Turn-On Response ($V_{IN}=3.3\ V$, $C_{OUT}=0.1\ \mu F$, $R_L=10\ \Omega$)

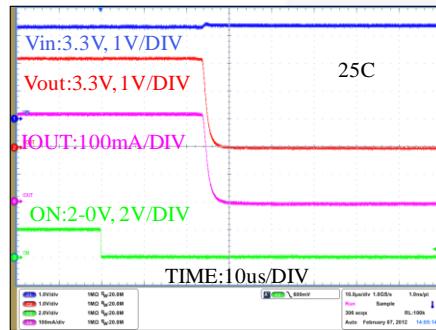

Figure 21. Turn-Off Response ($V_{IN}=3.3\ V$, $C_{OUT}=0.1\ \mu F$, $R_L=10\ \Omega$)

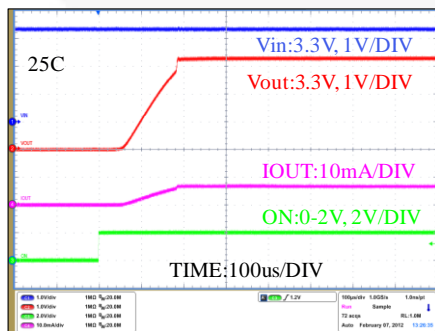

Figure 22. Turn-On Response ($V_{IN}=3.3\ V$, $C_{OUT}=0.1\ \mu F$, $R_L=500\ \Omega$)

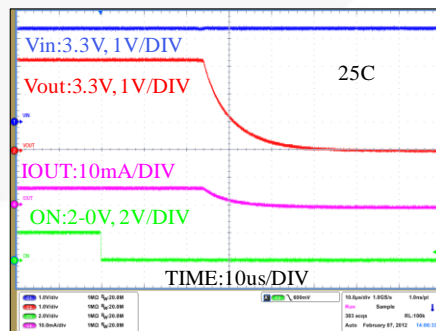

Figure 23. Turn-Off Response ($V_{IN}=3.3\ V$, $C_{OUT}=0.1\ \mu F$, $R_L=500\ \Omega$)

Application Information

Input Capacitor

IntelliMAX™ switches don't require an input capacitor. To reduce device inrush current, a 0.1 μF ceramic capacitor, C_{IN}, is recommended close to the VIN pin. A higher value of C_{IN} can be used to further reduce the voltage drop experienced as the switch is turned on into a large capacitive load.

Output Capacitor

IntelliMAX™ switches work without an output capacitor. If the applications parasitic board inductance forces V_{OUT} below GND when switching off, a 0.1 μF capacitor, C_{OUT}, should be placed between V_{OUT} and GND.

Fall Time

Device output fall time can be calculated based on RC constant of external components as follows:

$$t_F = R_L \times C_L \times 2.2 \quad (1)$$

where t_F is 90% to 10% fall time, R_L is output load, load and C_L is output capacitor.

The same equation works for a device with a pull-down output resistor, then R_L is replaced by a parallel connected pull-down and external output resistor combination, as follows:

$$t_F = \frac{R_L \times R_{PD}}{R_L + R_{PD}} \times C_L \times 2.2 \quad (2)$$

where t_F is 90% to 10% fall time, R_L is output load, R_{PD} is output pull-down resistor (65 Ω typical), and C_L is the output capacitor.

Recommended Land Pattern and Layout

For best thermal performance and minimal inductance and parasitic effects, it is recommended to keep input and output traces short and the capacitors as close to

the device as possible. Below is a recommended layout for this device to achieve optimum performance.

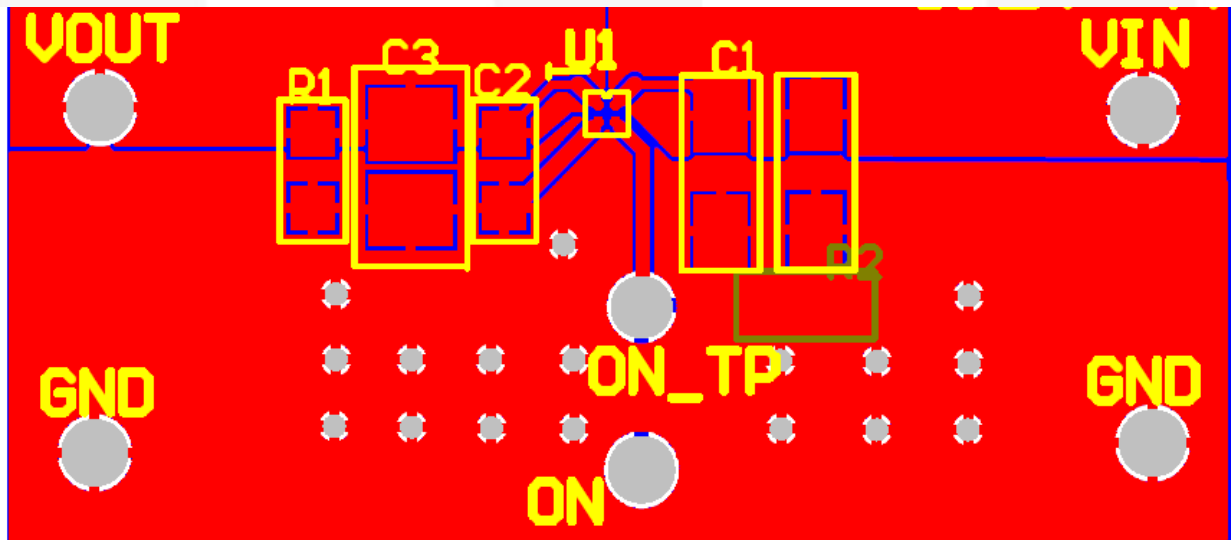

Figure 24. Recommended Land Pattern and Layout

The following information applies to the WLCSP package dimensions on the next page:

Product-Specific Dimensions

Product	D	E	X	Y
FPF1504UCX	960 μm \pm 30 μm	960 μm \pm 30 μm	0.230 mm	0.230 mm
FPF1504BUCX				
FPF1504LUCX				
FPF1504LBUCX				



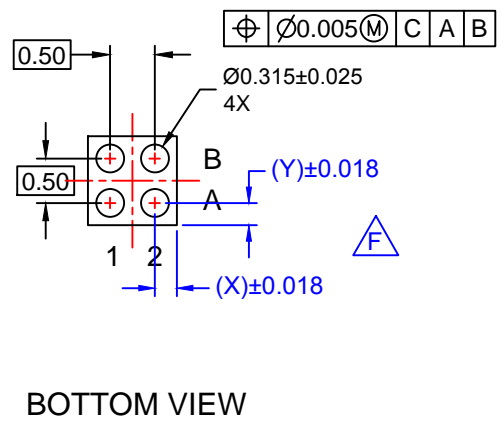
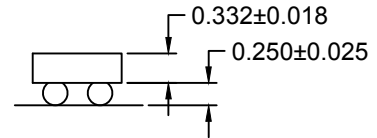
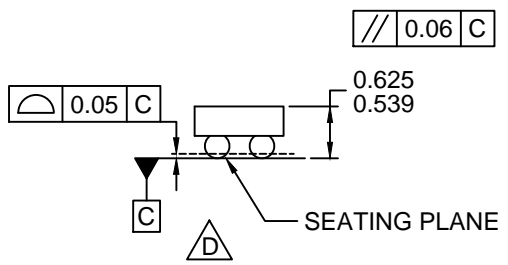
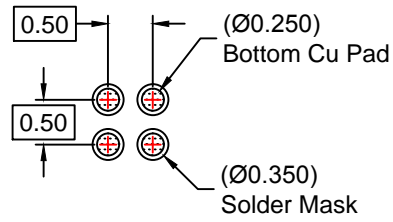
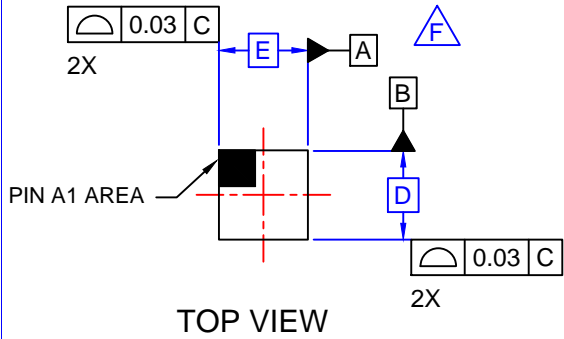

- NOTES:
- A. NO JEDEC REGISTRATION APPLIES.
 - B. DIMENSIONS ARE IN MILLIMETERS.
 - C. DIMENSIONS AND TOLERANCES PER ASME Y14.5M, 2009.
 - D. DATUM C IS DEFINED BY THE SPHERICAL CROWNS OF THE BALLS.
 - E. PACKAGE NOMINAL HEIGHT IS 582 MICRONS ±43 MICRONS (539-625 MICRONS).
 - F. FOR DIMENSIONS D, E, X, AND Y SEE PRODUCT DATASHEET.
 - G. DRAWING FILENAME: MKT-UC004ABrev3.



ON Semiconductor and  are trademarks of Semiconductor Components Industries, LLC dba ON Semiconductor or its subsidiaries in the United States and/or other countries. ON Semiconductor owns the rights to a number of patents, trademarks, copyrights, trade secrets, and other intellectual property. A listing of ON Semiconductor's product/patent coverage may be accessed at www.onsemi.com/site/pdf/Patent-Marking.pdf. ON Semiconductor reserves the right to make changes without further notice to any products herein. ON Semiconductor makes no warranty, representation or guarantee regarding the suitability of its products for any particular purpose, nor does ON Semiconductor assume any liability arising out of the application or use of any product or circuit, and specifically disclaims any and all liability, including without limitation special, consequential or incidental damages. Buyer is responsible for its products and applications using ON Semiconductor products, including compliance with all laws, regulations and safety requirements or standards, regardless of any support or applications information provided by ON Semiconductor. "Typical" parameters which may be provided in ON Semiconductor data sheets and/or specifications can and do vary in different applications and actual performance may vary over time. All operating parameters, including "Typicals" must be validated for each customer application by customer's technical experts. ON Semiconductor does not convey any license under its patent rights nor the rights of others. ON Semiconductor products are not designed, intended, or authorized for use as a critical component in life support systems or any FDA Class 3 medical devices or medical devices with a same or similar classification in a foreign jurisdiction or any devices intended for implantation in the human body. Should Buyer purchase or use ON Semiconductor products for any such unintended or unauthorized application, Buyer shall indemnify and hold ON Semiconductor and its officers, employees, subsidiaries, affiliates, and distributors harmless against all claims, costs, damages, and expenses, and reasonable attorney fees arising out of, directly or indirectly, any claim of personal injury or death associated with such unintended or unauthorized use, even if such claim alleges that ON Semiconductor was negligent regarding the design or manufacture of the part. ON Semiconductor is an Equal Opportunity/Affirmative Action Employer. This literature is subject to all applicable copyright laws and is not for resale in any manner.

PUBLICATION ORDERING INFORMATION

LITERATURE FULFILLMENT:

Literature Distribution Center for ON Semiconductor
19521 E. 32nd Pkwy, Aurora, Colorado 80011 USA
Phone: 303-675-2175 or 800-344-3860 Toll Free USA/Canada
Fax: 303-675-2176 or 800-344-3867 Toll Free USA/Canada
Email: orderlit@onsemi.com

N. American Technical Support: 800-282-9855 Toll Free
USA/Canada
Europe, Middle East and Africa Technical Support:
Phone: 421 33 790 2910
Japan Customer Focus Center
Phone: 81-3-5817-1050

ON Semiconductor Website: www.onsemi.com
Order Literature: <http://www.onsemi.com/orderlit>
For additional information, please contact your local
Sales Representative

Mouser Electronics

Authorized Distributor

Click to View Pricing, Inventory, Delivery & Lifecycle Information:

[ON Semiconductor:](#)

[FPF1504UCX](#) [FPF1504BUCX](#)



Стандарт Электрон Связь

Мы молодая и активно развивающаяся компания в области поставок электронных компонентов. Мы поставляем электронные компоненты отечественного и импортного производства напрямую от производителей и с крупнейших складов мира.

Благодаря сотрудничеству с мировыми поставщиками мы осуществляем комплексные и плановые поставки широчайшего спектра электронных компонентов.

Собственная эффективная логистика и склад в обеспечивает надежную поставку продукции в точно указанные сроки по всей России.

Мы осуществляем техническую поддержку нашим клиентам и предпродажную проверку качества продукции. На все поставляемые продукты мы предоставляем гарантию .

Осуществляем поставки продукции под контролем ВП МО РФ на предприятия военно-промышленного комплекса России , а также работаем в рамках 275 ФЗ с открытием отдельных счетов в уполномоченном банке. Система менеджмента качества компании соответствует требованиям ГОСТ ISO 9001.

Минимальные сроки поставки, гибкие цены, неограниченный ассортимент и индивидуальный подход к клиентам являются основой для выстраивания долгосрочного и эффективного сотрудничества с предприятиями радиоэлектронной промышленности, предприятиями ВПК и научно-исследовательскими институтами России.

С нами вы становитесь еще успешнее!

Наши контакты:

Телефон: +7 812 627 14 35

Электронная почта: sales@st-electron.ru

Адрес: 198099, Санкт-Петербург,
Промышленная ул, дом № 19, литера Н,
помещение 100-Н Офис 331