

Amphenol® 97 Series Standard Cylindrical Connector

12-022-14

MIL-5015 Style Connectors
widely used for:

- Factory Automation, Robotics
- Machine Tool, Instrumentation
- Welding Equipment
- Medical Equipment



Amphenol® 97 Series Connectors are
UL recognized and CSA recognized.

Amphenol

Table of Contents	Page
Amphenol® 97 Series Standard Cylindrical Connectors – General Description	1
Guide to Selecting a Connector	2
Amphenol® 97 Series Connectors with Solder Contacts	
Design Characteristics, Customer Options	3
Insert Availability	4, 5
Contact Arrangements	6-11
Alternate Insert Positioning	12
Receptacle Shell Styles	13
Solid Shell Plug Styles	14
Split Shell Plug Styles	15
Weight Reference Charts	16-18
How to Order	19
Amphenol® 97 Series Connectors with Rear Release Crimp Contacts	
Design Characteristics, Customer Options	20
Specifications and Insert Availability, Alternate Insert Positioning	21
Contact Arrangements	22, 23
Receptacle Shell Styles	24
Solid Shell Plug Styles	25
Split Shell Plug Styles	26
How to Order	27
Crimp Contact Information	28
Crimp Contact Information cont., Tools	29
Special Purpose Connectors	
Potting Construction	30
Box Type Plugs, Small Flange Receptacles	31
ECG Connector, Convenience Outlets	32
97 Series Accessories	
Cable Clamps, Bushing	33,34
Protection Caps	35, 36
Adapters	37
Conduit Box Connector, Conduit Coupling Nuts,	38
Sealing Gaskets	39
Dummy Receptacles	40
Additional Products	41, 42
Sales Office Listing	

Amphenol Aerospace operates Quality Systems that are Certified to ISO-9001 and AS-9100 by third party Registrars.

Amphenol® 97 Series Connectors

provide the interconnection solution for low cost, general duty applications

Amphenol offers the 97 Series Connector Family - A general duty standard cylindrical connector, MIL-5015 style.

The 97 Series is a widely used connector series for the automotive, robotics, machine tool and welding industries, as well as numerous other commercial applications from heavy equipment to ECG monitoring cables.

Shell components are fabricated from high grade aluminum alloy to provide strength and environmental protection. This family of connectors offers a wide variety of shell styles, contact patterns and accessory options.

The Amphenol® 97 Series design features and benefits:

- **Low cost, general duty non-environmental**
- **Environmental capability with the 417 suffix plus 9767 cable clamp (see page 34)**
- **Solder or crimp termination**
- **UL Recognized, CSA Recognized**
- **Wide selection of shell styles and insert patterns**
- **Wide selection of connector finishes - cadmium or non-cadmium (environmentally friendly zinc alloy)**
- **Threaded coupling, hard dielectric inserts**
- **Solid or split shell construction**
- **Accessories for both individual wire seal and jacketed cable**



RoHS COMPLIANT PRODUCT AVAILABLE – Consult Amphenol Industrial Operations.



For additional information on Amphenol® 97 Series connectors, or for special application requirements, contact your local Amphenol sales office, authorized distributor, or -

Amphenol Corporation
Amphenol Industrial Operations
40-60 Delaware Avenue
Sidney, New York 13838-1395
Telephone: 607-563-5011
Fax: 607-563-5157
Web site: www.amphenol-industrial.com

Guide to Selecting a Connector

In selecting a connector, it first must be determined if a non-environmental 97 A or B Series 5015 type is required or if an environmental MS-5015 Class E, F, or R type* is required.

If determined that the general duty, non-environmental 97 series is the choice - then this catalog is appropriate to your needs

The following 8 steps apply to formulation of a part number.**

1 How many wires are you going to connect? What gauge?

These two questions are important, because they indicate which insert you need. There are literally hundreds to choose from.

The insert arrangements for solder contact connectors are illustrated on pages 6-11. The inserts most often used are highlighted on these pages.

Here's an example of how to choose an insert arrangement. Say you want to connect eight 16-ga. wires, - first find the section of arrangements containing 8 contacts. Insert number 20-7 is the one you want because it contains eight 16-ga. contacts and it is one of the most often used. The one you choose might depend on your space or voltage requirements. The voltage capacity of each insert is listed under its diagram.

If you have more than one wire size to connect, the method is essentially the same. Actually, the insert configurations for multiple-size wires are a lot more flexible than they appear. That's because you can always solder a smaller wire to a larger contact. However, soldering a large wire to a small contact isn't recommended because of size and current requirements.

2 What if several identical connectors have different functions?

Here's a situation to watch out for. You have four identical receptacles on a panel. One carries high current loads.

The others have low current functions. A plug mated with the wrong receptacle (cross-mating) could ruin your valuable equipment.

To avoid cross-mating, you can order identical inserts positioned in both the plugs and receptacles at various angles from standard. These variations from standard position are called alternate insert positions, and are described on page 12.

3 What kind of receptacle do you need?

For Wall Mounting Use a wall receptacle, type 3100. The elongated back of this receptacle extends through thick wall material. It is threaded to accept standard hardware fittings.

For Unmounted Applications Use the cable receptacle, type 3101.

For Box or Panel Mounting Use the box receptacle, type 3102. This receptacle's back is short to conserve space. It is not threaded on the back end and is used when no accessories such as clamps are needed.

4 What kind of plug do you need?

For ordinary situations The straight plug, type 3106 meets most connector requirements. However . . .

when space is critical you may want to consider using an angle plug, type 3108. This type plug lets the cable enter your equipment at a right angle.

5 Do you need a plug with a Solid or Split back shell?

You can get both straight and angle plugs in solid or split back shell designs. With the solid shell you have greater strength and you save space. On the other hand, the split shell design lets you quickly inspect the solder terminals when you need to. This feature could be important if you'll be subjecting the connector to rough handling and heavy use.

The designation to use for solid shell construction is the letter A. This designation letter goes immediately

after the main shell type number: for example, 3106A or 3108A.

The designation for split shell construction is the letter B; for example, 3106B or 3108B.

Because of application, receptacles are made in solid backshell construction only. Their designation is 3100A, 3101A. (See how to order for solder contact connectors, page 19.)

6 Which connector gets the socket? - the receptacle or the plug?

You're at the point where you designate which inserts are used with which shells. Either pin or socket inserts can be used with plugs or receptacles.

Here's a good rule of thumb. Order the sockets for the connector at the "hot" side of the circuit. By having sockets at the power source, there's little chance that a wayward finger or screwdriver will short the circuit or cause personal injury.

The designation for sockets is simply S in a part number, following the insert code number. For pins, the designation is P. Therefore, the 20-7P insert would have pin contacts, while the 20-7S insert would have socket contacts.

7 What type of plating is preferred?

If you prefer the standard olive cadmium, non-reflective, electrically conductive finish, then no suffix number is required. Other plating variations are available, including environmentally friendly zinc alloy. See how to order instructions for the various plating finishes offered for 97 Series solder connectors on page 19.

8 Do you need any accessories?

Accessories - cable clamps, protection caps and chains, conduit adapters, and panel gaskets are shown on pages 33-39.

* If an environmental type MIL-5015 E, F or R Class is required, then the catalog that should be consulted is 12-020, MS/Standard MIL-5015 Cylindrical Connectors. See www.amphenol-industrial.com for on-line catalogs or contact Amphenol, Sidney, NY.

** These steps are for solder type connectors which are described in detail on pages 3-19. If a crimp type connector is needed, the same steps apply, however, you should consult pages 20-29 for details on 97 Series connectors with crimp contacts.

Amphenol® 97 Series Connectors with solder contacts



MS3100A



MS3107A



MS3101A



MS3107B



MS3102A



MS3108A



MS3106A



MS3108B



MS3106B

DESIGN CHARACTERISTICS

- Medium to heavy weight cylindrical
- Durable, field-proven design
- Single key/keyway polarization
- Threaded coupling, hard dielectric inserts
- Non-rotating contacts
- Operating temperatures from -55°C to $+125^{\circ}\text{C}$
- Cost effective
- Intermateable and intermountable with existing 97 Series and MIL-5015 connectors
- Underwriters Laboratories approved recognition File E115497
- Canadian Standards Association Certification File LR69183

CUSTOMER OPTIONS

- Solid or split shell construction
- Six shell styles
- 128 contact arrangements, from 1 to 52 circuits
- Alternate insert positioning
- High temperature and potting constructions
- Special plating finishes including black and green zinc alloy
- Optional gold plating on MS contacts
- Thermocouple arrangements available

Connector components are fabricated from high grade aluminum alloy, with a conductive cadmium plate finish and an olive drab chromate after-treatment. Some cable clamps are a zinc alloy with an olive drab/green chromate finish. See how to order page 19 for other finish variations.

Contacts are silver plated with pre-tinned solder cups. Optional gold over silver plating is also available. Inserts for solder style contacts are diallyl-phthalate.

Users should be aware that classes "A" and "B" of MIL-5015 have been cancelled, and these products are no longer qualified.

97 series solder type insert availability

Insert Number	Total Contacts	Mechanical Spacing		Service Rating	Contact Size				
		Inches	mm		0	4	8	12	16
8S-1+	1	1/16	1.57	INST.					1
10SL-3	3	1/16	1.57	A					3
10SL-4	2	1/16	1.57	A					2
12SL-844+*	4	1/16	1.57	A					4
12S-3	2	1/16	1.57	A					2
12-5+	1	1/8	3.18	D				1	
12S-6+*	2	1/16	1.57						2 Thermo-couple
14S-1†	3	1/16	1.57	A					3
14S-2	4			INST.					4
14S-4+†	1	1/8	3.18	D					1
14S-5	5			INST.					5
14S-6	6			INST.					6
14S-7	3	1/16	1.57	A					3
14S-9†	2	1/16	1.57	A					2
16S-1	7	1/16	1.57	A					7
16S-4+	2	1/8	3.18	D					2
16S-5	3	1/16	1.57	A					3
16S-6+†	3	1/16	1.57	A					3
16-7	3	1/16	1.57	A			1		2
16S-8	5	1/16	1.57	A					5
16-9	4	1/16	1.57	A				2	2
16-10	3	1/16	1.57	A				3	
16-11+†	2	1/16	1.57	A				2	
16-12	1	1/16	1.57	A		1			
16-13	2	1/16	1.57	A					2 Thermo-couple
18-1	10	1/16	1.57	A					4
				INST.					6
18-3†	2	1/8	3.18	D				2	
18-4	4	1/8	3.18	D					4
18-5+	3	1/8	3.18	D				2	1
18-8	8	1/16	1.57	A				1	7
18-9+	7			INST.				2	5
18-10†	4	1/16	1.57	A				4	
18-11	5	1/16	1.57	A				5	
18-12†	6	1.16	1.57	A					6
18-13	4	1/16	1.57	A			1	3	
18-16	1	5/16	7.92	C				1	
18-19†	10	1/16	1.57	A					10
18-20	5	1/16	1.57	A					5
18-22†	3	1/8	3.18	D					3
18-29+†	5	1/16	1.57	A					5
18-420*	1								1 Hi-Voltage**
20-3†	3	1/8	3.18	D				3	

Insert Number	Total Contacts	Mechanical Spacing		Service Rating	Contact Size				
		Inches	mm		0	4	8	12	16
20-4	4	1/8	3.18	D				4	
20-6†	3	1/8	3.18	D					3
20-7	8	1/8	3.18	D					4
		1/16	1.57	A					4
20-8	6			INST.			2		4
20-11†	13			INST.					13
20-14	5	1/16	1.57	A			2	3	
20-15	7	1/16	1.57	A				7	
20-16	9	1/16	1.57	A				2	7
20-17	6	1/16	1.57	A				5	1
20-18	9	1/16	1.57	A				3	6
20-19†	3	1/16	1.57	A			3		
20-21	9	1/16	1.57	A				1	8
20-23	2	1/16	1.57	A			2		
20-24	4	1/16	1.57	A			2		2
20-27	14	1/16	1.57	A					14
20-29	17	1/16	1.57	A					17
20-33	11	1/16	1.57	A					11
22-1†	2	1/8	3.18	D			2		
22-2	3	1/8	3.18	D			3		
22-4†	4	1/16	1.57	A			2	2	
22-5	6	1/8	3.18	D			2	4	
22-8†	2	3/16	4.75	E				2	
22-9	3	3/16	4.75	E				3	
22-10	4	3/16	4.75	E					4
22-11	2	1/4	6.35	B					2
22-12	5	1/8	3.18	D			2		3
22-13†	5	1/8	3.18	D					1
		1/16	1.57	A				4	
22-14	19	1/16	1.57	A					19
22-15	6	3/16	4.75	E					1
		1/16	1.57	A				5	
22-16†	9	1/16	1.57	A				3	6
22-18	8	1/8	3.18	D					5
		1/16	1.57	A					3
22-19	14	1/16	1.57	A					14
22-20†	9	1/16	1.57	A					9
22-22	4	1/16	1.57	A			4		
22-23	8	1/8	3.18	D				1	
		1/16	1.57	A				7	

Not all insert arrangements are currently available for environmental individual wire seal. Consult Amphenol, Sidney, NY for availability.

† Inactive for new military design, but available for replacement or for non-military purposes.

* "MS" number not assigned. Use "97" prefix in place of "MS" in completing catalog number. See how to order, page 19.

** Hi-Voltage = 17KVAC/24KVDC

♦ Molded-in pin (MIP) insert requires (910) deviation. See how to order, pg. 19.

97 series solder type insert availability, cont.

Insert Number	Total Contacts	Mechanical Spacing		Service Rating	Contact Size				
		Inches	mm		0	4	8	12	16
22-26*	7	1/8	3.18					2	5
22-27	9	1/8	3.18	D			1		
		1/16	1.57	A					8
22-28†	7	1/16	1.57	A				7	
22-34	5	1/8	3.18	D				3	2
24-2	7	1/8	3.18	D				7	
24-5†	16	1/16	1.57	A					16
24-6	8	1/8	3.18	D				3	
		1/16	1.57	A				5	
24-7	16	1/16	1.57	A				2	14
24-9†	2	1/16	1.57	A		2			
24-10	7	1/16	1.57	A			7		
24-11	9	1/16	1.57	A			3	6	
24-12	5	1/16	1.57	A		2		3	
24-16	7	1/8	3.18	D			1		3
		1/16	1.57	A				3	
24-19†	12	1/16	1.57						12
24-20*	11	1/8	3.18	D				2	9
24-21	10	1/8	3.18	D			1		9
24-22*	4	1/8	3.18	D			4		
24-27	7	3/16	4.75	E					7
24-28	24	1/16	1.57	INST.					24
28-1	9	1/8	3.18	D			1	2	
		1/16	1.57	A			2	4	
28-2	14	1/8	3.18	D				2	12
28-3	3	3/16	4.75	E			3		
28-6†	3	1/8	3.18	D		3			
28-8	12	1/16	1.57	A					9
		1/8	3.18	D					1
		3/16	4.75	E				2	
28-9	12	1/8	3.18	D				6	6
28-10	7	1/8	3.18	D				1	
		1/16	1.57	A		2	2	2	
28-11	22	1/16	1.57	A				4	18
28-12	26	1/16	1.57	A					26
28-15†	35	1/16	1.57	A					35
28-16†	20	1/16	1.57	A					20
28-17	15	1/4	6.35	B					1
		1/8	3.18	D					3
		1/16	1.57	A					11
28-18	12	5/16	7.92	C					1
		1/8	3.18	D					5
		1/16	1.57	A					2
				INST.				4	
28-19	10	1/4	6.35	B					2
		1/8	3.18	D					2
		1/16	1.57	A				4	2

Insert Number	Total Contacts	Mechanical Spacing		Service Rating	Contact Size				
		Inches	mm		0	4	8	12	16
28-20	14	1/16	1.57	A				10	4
28-21	37	1/16	1.57	A					37
32-5†	2	1/8	3.18	D	2				
32-6	23	1/16	1.57	A		2	3	2	16
32-7	35	1/16	1.57	A				7	24
				INST.					4
32-8†	30	1/16	1.57	A				6	24
32-13	23	1/8	3.18	D				5	18
32-17	4	1/8	3.18	D		4			
32-414	52	1/16	1.57	A					52
36-1†	22	1/8	3.18	D				4	18
36-5	4	1/16	1.57	A	4				
36-6	6	1/16	1.57	A	2	4			
36-7	47	1/16	1.57	A				7	40
36-8	47	1/16	1.57	A				1	46
36-9	31	1/16	1.57	A		1	2	14	14
36-10	48	1/16	1.57	A					48
36-15	35	1/16	1.57	A					34
		1/8	3.18	D					1
36-403*	52	1/16	1.57	A					52

Not all insert arrangements are currently available for environmental individual wire seal. Consult Amphenol, Sidney, NY for availability.

† Inactive for new military design, but available for replacement or for non-military purposes.

* "MS" number not assigned. Use "97" prefix in place of "MS" in completing catalog number. See how to order, page 19.

♣ Molded-in pin (MIP) insert requires (910) deviation. See how to order, pg. 19.

97 series solder type insert arrangements

Front view of pin insert or rear of socket insert illustrated.

Items highlighted are most popular and most readily available.

1 Contact

Insert Arrangement	8S-1	12-5	14S-4†	16-12	18-16	18-420*
Contacts	1#16	1#12	1#16	1#4	1#12	1#12
Service Rating	INST.	D	D	A	C	High Voltage 17KVAC/24KVDC

2 Contacts

Insert Arrangement	10SL-4	12S-3	12S-6*	14S-9†	16S-4	16-11†	16-13
Contacts	2#16	2#16	2#16	2#16	2#16	2#12	2#12
Service Rating	A	A	Thermocouple	A	D	A	A

Insert Arrangement	18-3†	20-23†	22-1†	22-8†	22-11	24-9†	32-5†
Contacts	2#12	2#8	2#8	2#12	2#16	2#4	2#0
Service Rating	D	A	D	E	B	A	D

3 Contacts

Insert Arrangement	10SL-3	14S-1†	14S-7	16S-5†	16S-6†	16-7	16-10	18-22†
Contacts	3#16	3#16	3#16	3#16	3#16	1#8, 2#16	3#12	3#16
Service Rating	A	A	A	A	A	A	A	D

Insert Arrangement	20-3†	20-6†	20-19†	22-2	22-9	28-3	28-6†
Contacts	3#12	3#16	3#8	3#8	3#12	3#8	3#4
Service Rating	D	D	A	D	E	E	D

97 series solder type insert arrangements, cont.

Front view of pin insert or rear of socket insert illustrated.

Items highlighted are most popular and most readily available.

4 Contacts

Insert Arrangement	12SL-844*	14S-2†	16-9	18-4	18-10†	18-13	20-4
Contacts	4#16	4#16	2#12, 2#16	4#16	4#12	3#12, 1#8	4#12
Service Rating	1/16" spacing	INST.	A	D	A	A	D
Insert Arrangement	20-24	22-4†	22-10	22-22	24-22	32-17	36-5
Contacts	2#8, 2#16	2#8, 2#12	4#16	4#8	4#8	4#4	4#0
Service Rating	A	A	E	A	D	D	A

5 Contacts

Insert Arrangement	14S-5	16S-8	18-11	18-20†	18-29†	20-14
Contacts	5#16	5#16	5#12	5#16	5#16	3#12, 2#8
Service Rating	INST.	A	A	A	A	A
Insert Arrangement	22-12	22-13†	22-34†	24-12		
Contacts	2#8, 3#16	1#16, 4#12	3#12, 2#16	2#4, 3#12		
Service Rating	D	E = D; A, B, C, D = A	D	A		

MIL-SPEC SERVICE RATING

		INST.	A	D	E	B	C
Limiting Operating	DC	250	700	1250	1750	2450	4200
Voltages at Sea Level	AC (rms)	200	500	900	1250	1750	3000

See notes 1 and 2 under TEST CURRENT.

INST. service normally for low voltage and currents.

Effective Creepage (nominal)	Inch	1/16	1/8	3/16	1/4	5/16	1
	mm	1.57	3.18	4.75	6.35	7.92	25.40
Mechanical Spacing (nominal)	Inch	1/16	1/8	3/16	1/4	5/16	
	mm	1.57	3.18	4.75	6.35	7.92	

TEST CURRENT

Contact Size	16	12	8	4	0
Amperes	13	23	46	80	150

NOTE 1: Transients were not considered in calculating these values.

NOTE 2: Limiting operating voltages at 50,000 feet altitude are approximately 25% of the sea level values.

CONTACT LEGEND

16	12	8	4	0	16	12	16 12
				IRON			
				CONSTANTAN			

† Inactive for new military design, but available for replacement or for non-military purposes.

* "MS" number not assigned. Use "97" prefix in place of "MS" in completing catalog number. See how to order, page 19.

97 series solder type insert arrangements, cont.

Front view of pin insert or rear of socket insert illustrated.

Items highlighted are most popular and most readily available.

6 Contacts

Insert Arrangement	14S-6	18-12†	20-8	20-17	22-5	22-15	36-6
Contacts	6#16	6#16	4#16, 2#8	5#12, 1#16	2#12, 4#16	5#12, 1#16	2#0, 4#4
Service Rating	INST.	A	INST.	A	D	D = E; A, B, C, E, F = A	A

7 Contacts

Insert Arrangement	16S-1	18-9	20-15	22-26*	22-28†
Contacts	7#16	5#16, 2#12	7#12	2#12, 5#16	7#12
Service Rating	A	INST.	A	1/8" spacing	A

Insert Arrangement	24-2	24-10	24-16	24-27	28-10
Contacts	7#12	7#8	3#16, 1#8, 3#12	7#16	3#12, 2#8, 2#4
Service Rating	D	A	A, B, F, G = D; C, D, E = A	E	G = D; all others = A

8 Contacts

Insert Arrangement	18-8	20-7	22-18	22-23	24-6
Contacts	1#12, 7#16	8#16	8#16	8#12	8#12
Service Rating	A	A, B, H, G = D; C, D, E, F = A	A, B, H, F, G = D; all others = A	H = D; all others = A	A, G, H = D; all others = A

97 series solder type insert arrangements, cont.

Front view of pin insert or rear of socket insert illustrated.

Items highlighted are most popular and most readily available.

9 Contacts

Insert Arrangement	20-16	20-18	20-21	22-16†	22-20†
Contacts	7#16, 2#12	3#12, 6#16	1#12, 8#16	3#12, 6#16	9#16
Service Rating	A	A	A	A	A
Insert Arrangement	22-27	24-11	28-1		
Contacts	1#8, 8#16	3#8, 6#12	3#8, 6#12		
Service Rating	J = D; all others = A	A	A, J, E = D; all others = A		

10 Contacts

Insert Arrangement	18-1	18-19	24-21	28-19
Contacts	10#16	10#16	1#8, 9#16	4#12, 6#16
Service Rating	B, C, F, G = A; all others = INST.	A	D	H, M = B; A, B = D; all others = A

11 Contacts

Insert Arrangement	20-33	24-20
Contacts	11#16	2#12, 9#16
Service Rating	A	D

12 Contacts

Insert Arrangement	24-19†	28-8	28-9	28-18
Contacts	12#16	2#12, 10#16	6#12, 6#16	12#16
Service Rating	1/16" spacing	L, M = E; B = D; all others = A	D	M = C; A, B = A C, D, E, F = INST.; all others = D

13 Contacts

Insert Arrangement	20-11†
Contacts	13#16
Service Rating	INST.

† Inactive for new military design, but available for replacement or for non-military purposes.

* "MS" number not assigned. Use "97" prefix in place of "MS" in completing catalog number. See how to order, page 19.

See Service Rating and Test Current information on page 7.

CONTACT LEGEND

16	12	8	4	0

97 series solder type insert arrangements, cont.

Front view of pin insert or rear of socket insert illustrated.

Items highlighted are most popular and most readily available.

14 Contacts

				
Insert Arrangement	20-27	22-19	28-2	28-20
Contacts	14#16	14#16	2#12, 12#16	10#12, 4#16
Service Rating	A	A	D	A

15 Contacts

	
Insert Arrangement	28-17
Contacts	15#16
Service Rating	R = B; M, N, P = D; all others = A

16 Contacts

		
Insert Arrangement	24-5†	24-7
Contacts	16#16	2#12, 14#16
Service Rating	A	A

17 Contacts

	
Insert Arrangement	20-29
Contacts	17#16
Service Rating	A

19 Contacts

	
Insert Arrangement	22-14
Contacts	19#16
Service Rating	A

20 Contacts

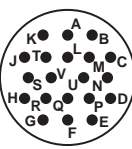
	
Insert Arrangement	28-16†
Contacts	20#16
Service Rating	A

22 Contacts

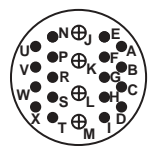
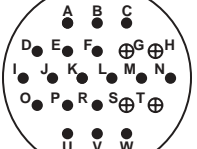
		
Insert Arrangement	28-11	36-1†
Contacts	4#12, 18#16	4#12, 18#16
Service Rating	A	D

23 Contacts

		
Insert Arrangement	32-6	32-13
Contacts	2#4, 3#8, 2#12, 16#16	5#12, 18#16
Service Rating	A	D

24 Contacts

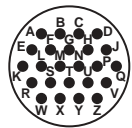
	
Insert Arrangement	24-28
Contacts	24#16
Service Rating	INST.

26 Contacts

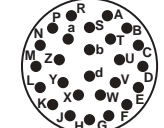
	
Insert Arrangement	28-12
Contacts	26#16
Service Rating	A

30 Contacts

	
Insert Arrangement	32-8†
Contacts	6#12, 24#16
Service Rating	A

31 Contacts

	
Insert Arrangement	36-9
Contacts	1#4, 2#8, 14#12, 14#16
Service Rating	A

97 series solder type insert arrangements, cont.

Front view of pin insert or rear of socket insert illustrated.

Items highlighted are most popular and most readily available.

35 Contacts

Insert Arrangement	28-15†	32-7	36-15
Contacts	35#16	7#12, 28#16	35#16
Service Rating	A	A, B, h, j = INST; all others = A	m = D; all others = A

37 Contacts

Insert Arrangement	28-21
Contacts	37#16
Service Rating	A

47 Contacts

Insert Arrangement	36-7	36-8
Contacts	7#12, 40#16	1#12, 46#16
Service Rating	A	A

48 Contacts

Insert Arrangement	36-10
Contacts	48#16
Service Rating	A

52 Contacts

Insert Arrangement	32-414*	36-403*
Contacts	52#16	52#16
Service Rating	A	A

† Inactive for new military design, but available for replacement or for non-military purposes.

* "MS" number not assigned. Use "97" prefix in place of "MS" in completing catalog number. See how to order, page 19.

See Service Rating and Test Current information on page 7.

CONTACT LEGEND

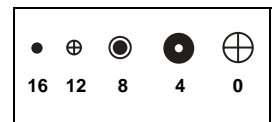

97 series solder type alternate insert positioning

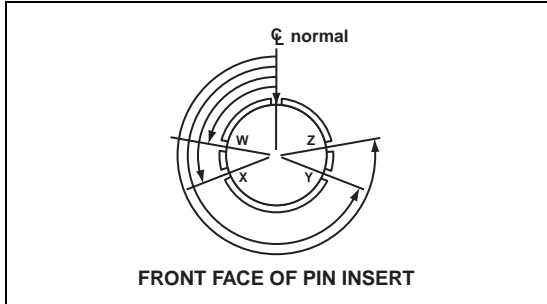

Insert Arrangement	Degrees			
	W	X	Y	Z
12S-3	70	145	215	290
14S-2	—	120	240	—
14S-5	—	110	—	—
14S-7	90	180	270	—
14S-9	70	145	215	290
16S-1	80	—	—	280
16S-4	35	110	250	325
16S-5	70	145	215	290
16S-6	90	180	270	—
16-7	80	110	250	280
16S-8	—	170	265	—
16-9	35	110	250	325
16-10	90	180	270	—
16-11	35	110	250	325
16-13	35	110	250	325
18-1	70	145	215	290
18-3	35	110	250	325
18-4	35	110	250	325
18-5	80	110	250	280
18-8	70	—	—	290
18-9	80	110	250	280
18-10	—	120	240	—
18-11	—	170	265	—
18-12	80	—	—	280
18-13	80	110	250	280
18-19	—	120	240	—
18-20	90	180	270	—
18-22	70	145	215	290
18-29	90	180	270	—
20-3	70	145	215	290
20-4	45	110	250	—
20-6	70	145	215	290
20-7	80	110	250	280
20-8	80	110	250	280
20-14	80	110	250	280
20-15	80	—	—	280
20-16	80	110	250	280
20-17	90	180	270	—
20-18	35	110	250	325
20-19	90	180	270	—
20-21	35	110	250	325
20-23	35	110	250	325
20-24	35	110	250	325
20-27	35	110	250	325
20-29	80	—	—	280

Insert Arrangement	Degrees			
	W	X	Y	Z
22-1	35	110	250	325
22-2	70	145	215	290
22-4	35	110	250	325
22-5	35	110	250	325
22-8	35	110	250	325
22-9	70	145	215	290
22-10	35	110	250	325
22-11	35	110	250	325
22-12	80	110	250	280
22-13	35	110	250	325
22-14	80	110	250	280
22-15	80	110	250	280
22-16	80	110	250	280
22-18	80	110	250	280
22-19	80	110	250	280
22-20	35	110	250	325
22-22	—	110	250	—
22-23	35	—	250	—
22-27	80	—	250	280
22-28	80	—	—	280
22-34	80	110	250	280
24-2	80	—	—	280
24-5	80	110	250	280
24-6	80	110	250	280
24-7	80	110	250	280
24-9	35	110	250	325
24-10	80	—	—	280
24-11	35	110	250	325
24-12	80	110	250	280
24-16	80	110	250	280
24-20	80	110	250	280
24-21	80	110	250	280
24-22	45	110	250	—
24-27	80	—	—	280
24-28	80	110	250	280
28-1	80	110	250	280
28-2	35	110	250	325
28-3	70	145	215	290
28-6	70	145	215	290
28-8	80	110	250	280
28-9	80	110	250	280
28-10	80	110	250	280
28-11	80	110	250	280
28-12	90	180	270	—
28-15	80	110	250	280
28-16	80	110	250	280
28-17	80	110	250	280
28-18	70	145	215	290
28-19	80	110	250	280
28-20	80	110	250	280
28-21	80	110	250	280
32-5	35	110	250	325
32-6	80	110	250	280
32-7	80	125	235	280
32-8	80	125	235	280
32-13	80	110	250	280
32-17	45	110	250	—
32-414*	80*	110*	250*	280*
36-1	80	110	250	280
36-5	—	120	240	—
36-6	35	110	250	325
36-7	80	110	250	280
36-8	80	110	250	280
36-9	80	125	235	280
36-10	80	125	235	280
36-15	60	125	245	305

*Rotates opposite above illustration.

97 series solder type receptacles

MS3100A wall mount receptacle

Solid shell construction is strong and conserves space. Includes integral polarizing key in front. Back shell is threaded for standard MS/AN fittings.

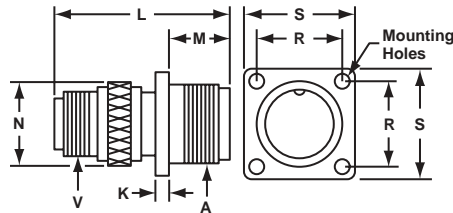

MS3101A cable receptacle

Solid shell construction is strong and conserves space. Includes integral polarizing key in front shell. Machined back shell is threaded for standard MS/AN fittings. Can be unscrewed for inspection or soldering.

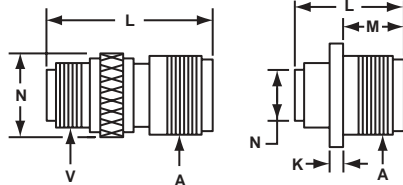

MS3102A box receptacle

Solid shell designed for open wiring. Mounts directly on chassis, equipment or panel. Includes internal polarized key in front shell.

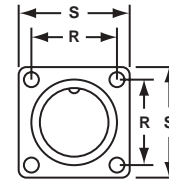

Mounting Holes
 .173 (4.394) DIA.
 FOR SIZE 32 AND 36
 .147 (3.734) DIA.
 FOR SIZES 24 AND 28
 .120 (3.048) DIA.
 FOR ALL OTHER SIZES

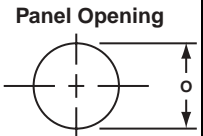

MS3100A and MS3101A

Connector Size	A Coupling Thread	K Ref.		L Max.		M Ref.		N Ref.		O Ref.		R Ref.		S Ref.		V Fitting Threads
		Inch	mm	Inch	mm	Inch	mm	Inch	mm	Inch	mm	Inch	mm	Inch	mm	
8S	1/2-28	5/64	1.98	1-1/4	31.75	9/16	14.27	17/32	13.49	.562	14.27	19/32	15.06	7/8	22.23	1/2-28
10S	5/8-24	5/64	1.98	1-5/16	33.32	9/16	14.27	5/8	15.88	.688	17.48	23/32	18.24	1	25.40	1/2-28
10SL	5/8-24	5/64	1.98	1-9/32	32.53	9/16	14.27	3/4	19.05	.812	20.62	23/32	18.24	1	25.40	5/8-24
12S	3/4-20	5/64	1.98	1-15/32	37.29	9/16	14.27	25/32	19.84	.812	20.62	13/16	20.62	1-3/32	27.76	5/8-24
12	3/4-20	5/64	1.98	1-27/32	46.81	3/4	19.05	25/32	19.84	.812	20.62	13/16	20.62	1-3/32	27.76	5/8-24
14S	7/8-20	5/64	1.98	1-15/32	37.39	9/16	14.27	7/8	22.23	.938	23.83	29/32	23.01	1-3/16	30.15	3/4-20
14	7/8-20	5/64	1.98	1-55/64	47.04	3/4	19.05	7/8	22.23	.938	23.83	29/32	23.01	1-3/16	30.15	3/4-20
16S	1 -20	5/64	1.98	1-15/32	37.39	9/16	14.27	1	25.40	1.062	26.97	31/32	24.59	1-9/32	32.54	7/8-20
16	1 -20	1/8	3.18	1-57/64	47.85	3/4	19.05	1	25.40	1.062	26.97	31/32	24.59	1-9/32	32.54	7/8-20
18	1-1/8-18	1/8	3.18	1-63/64	50.24	3/4	19.05	1-1/8	28.58	1.188	30.18	1-1/16	26.97	1-3/8	34.93	1 -20
20	1-1/4-18	1/8	3.18	1-57/64	47.85	3/4	19.05	1-1/4	31.75	1.312	33.32	1-5/32	29.36	1-1/2	38.10	1-3/16-18
22	1-3/8-18	1/8	3.18	1-63/64	50.24	3/4	19.05	1-3/8	34.93	1.438	36.53	1-1/4	31.75	1-5/8	39.67	1-3/16-18
24	1-1/2-18	1/8	3.18	2-1/4	57.15	13/16	20.62	1-1/2	38.10	1.562	36.67	1-3/8	34.93	1-3/4	44.45	1-7/16-18
28	1-3/4-18	1/8	3.18	2-1/4	57.15	13/16	20.62	1-3/4	44.45	1.812	46.02	1-9/16	39.67	2	50.80	1-7/16-18
32	2 -18	1/8	3.18	2-3/8	60.33	7/8	22.23	2-1/32	51.59	2.062	52.37	1-3/4	44.45	2-1/4	57.15	1-3/4-18
36	2-1/4-16	1/8	3.18	2-3/8	60.33	7/8	22.23	2-1/4	57.15	2.312	58.72	1-15/16	49.20	2-1/2	63.50	2 -18

MS3102A

Connector Size	A Coupling Thread	K Ref.		L Max.		M Ref.		N Ref.		O Ref.		R Ref.		S Ref.	
		Inch	mm	Inch	mm	Inch	mm	Inch	mm	Inch	mm	Inch	mm	Inch	mm
8S	1/2-28	5/64	1.98	55/64	21.82	9/16	14.27	7/16	11.10	.562	14.27	19/32	15.06	7/8	22.23
10S	5/8-24	5/64	1.98	55/64	21.82	9/16	14.27	1/2	12.70	.688	17.48	23/32	18.24	1	25.40
10SL	5/8-24	5/64	1.98	61/64	24.21	35/64	13.87	11/16	17.48	.812	20.62	23/32	18.24	1	25.40
12S	3/4-20	5/64	1.98	31/32	24.61	9/16	14.27	11/16	17.45	.812	20.62	13/16	20.62	1-3/32	27.76
12	3/4-20	5/64	1.98	1-21/64	33.73	3/4	19.05	11/16	17.45	.812	20.62	13/16	20.62	1-3/32	27.76
12SL	3/4-20	5/64	1.98	27/32	21.44	35/64	13.87	11/16	17.45	.938	23.83	13/16	20.62	1-3/32	27.76
14S	7/8-20	5/64	1.98	61/64	24.21	9/16	14.27	3/4	19.05	.938	23.83	29/32	23.01	1-3/16	30.15
14	7/8-20	5/64	1.98	1-11/32	34.14	3/4	19.05	3/4	19.05	.938	23.83	29/32	23.01	1-3/16	30.15
16S	1 -20	5/64	1.98	61/64	24.21	9/16	14.27	7/8	22.23	1.062	26.97	31/32	24.59	1-9/32	32.54
16	1 -20	1/8	3.18	1-3/8	34.92	3/4	19.05	7/8	22.23	1.062	26.97	31/32	24.59	1-9/32	32.54
18	1-1/8-18	1/8	3.18	1-3/8	34.92	3/4	19.05	1	25.40	1.188	30.18	1-1/16	26.97	1-3/8	34.93
20	1-1/4-18	1/8	3.18	1-3/8	34.92	3/4	19.05	1-1/8	28.58	1.312	33.32	1-5/32	29.36	1-1/2	38.10
22	1-3/8-18	1/8	3.18	1-3/8	34.92	3/4	19.05	1-1/4	31.75	1.438	36.53	1-1/4	31.75	1-5/8	41.28
24	1-1/2-18	1/8	3.18	1-3/8	34.92	13/16	20.62	1-3/8	34.93	1.562	39.67	1-3/8	34.93	1-3/4	44.45
28	1-3/4-18	1/8	3.18	1-3/8	34.92	13/16	20.62	1-5/8	41.28	1.812	46.02	1-9/16	39.67	2	50.80
32	2 -18	1/8	3.18	1-15/32	37.31	7/8	22.23	1-29/32	48.41	2.062	52.37	1-3/4	44.45	2-1/4	57.15
36	2-1/4-16	1/8	3.18	1-15/32	37.31	7/8	22.23	2-1/8	53.98	2.312	58.72	1-15/16	49.20	2-1/2	63.50

97 series solder type plugs with solid shells

MS3106A

Connector Size	L Max.		N Ref.		Q Max.		V Fitting Threads
	Inch	mm	Inch	mm	Inch	mm	
8S	1-1/4	31.75	17/32	13.49	3/4	19.05	1/2-28
10S	1-5/16	33.32	5/8	15.88	7/8	22.23	1/2-28
10SL	1-3/8	34.93	3/4	19.05	7/8	22.23	5/8-24
12S	1-7/16	36.50	25/32	19.84	1	25.40	5/8-24
12	1-7/8	47.63	25/32	19.84	1	25.40	5/8-24
12SL	1-31/64	37.69	7/8	22.23	1	25.40	3/4-20
14S	1-15/32	37.13	7/8	22.23	1-1/8	28.58	3/4-20
14	1-7/8	47.47	7/8	22.23	1-1/8	28.58	3/4-20
16S	1-15/32	37.13	1	25.40	1-1/4	31.75	7/8-20
16	1-7/8	47.47	1	25.40	1-1/4	31.75	7/8-20
18	1-31/32	49.88	1-1/8	28.57	1-11/32	34.11	1 -20
20	1-7/8	47.50	1-1/4	31.75	1-15/32	37.29	1-3/16-18
22	1-31/32	49.88	1-3/8	34.93	1-19/32	40.46	1-3/16-18
24	2-1/4	57.15	1-1/2	38.10	1-23/32	43.64	1-7/16-18
28	2-1/4	57.15	1-3/4	44.45	1-31/32	49.99	1-7/16-18
32	2-3/8	60.33	2-1/32	51.59	2-7/32	56.34	1-3/4-18
36	2-3/8	60.33	2-1/4	57.15	2-15/32	62.69	2 -18

MS3106A straight plug

Sturdy, simple to assemble. Coupling ring machined from solid aluminum bar stock for high tensile strength. Mates with all types of MS receptacles. Front shell includes polarizing keyway. Back shell is threaded for standard MS/AN fittings.

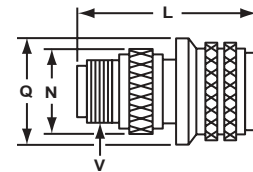

MS3107A

Connector Size	L Max.		N Ref.		Q Max.		V Fitting Threads
	Inch	mm	Inch	mm	Inch	mm	
10S	1-5/16	33.32	5/8	15.88	7/8	22.23	1/2-28
10SL	1-3/8	34.92	3/4	19.05	7/8	22.23	5/8-24
12S	1-7/16	36.50	25/32	19.84	1	25.40	5/8-24
12	1-7/8	47.63	25/32	19.84	1	25.40	5/8-24
14S	1-15/32	37.13	7/8	22.23	1-1/8	38.58	3/4-20
14	1-7/8	47.47	7/8	22.23	1-1/8	28.58	3/4-20
16S	1-15/32	37.13	1	25.40	1-1/4	31.75	7/8-20
16	1-7/8	47.47	1	25.40	1-1/4	31.75	7/8-20
18	1-31/32	49.88	1-1/8	28.58	1-11/32	34.11	1 -20
20	1-7/8	47.50	1-1/4	31.75	1-15/32	37.29	1-3/16-18
22	1-31/32	49.88	1-3/8	34.93	1-19/32	40.46	1-3/16-18
24	2-1/4	57.15	1-1/2	38.10	1-23/32	43.64	1-7/16-18
28	2-1/4	57.15	1-3/4	44.45	1-31/32	49.99	1-7/16-18

MS3107A quick-disconnect plug

For fast connect/disconnect applications. Front shell has polarizing keyway. Mates with all types of MS receptacles. Back shell is threaded for standard MS/AN fittings.

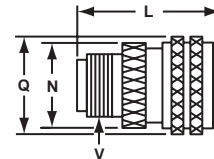

MS3108A

Connector Size	L Ref.		Q Max.		U Ref.		V Fitting Threads	Y Ref.	
	Inch	mm	Inch	mm	Inch	mm		Inch	mm
10S	1-1/4	31.75	7/8	22.23	7/8	22.23	1/2-28	25/32	19.84
10SL	1-5/16	33.32	7/8	22.23	1	25.40	5/8-24	1-1/16	26.97
12S	1-3/8	34.93	1	25.40	1	25.40	5/8-24	1-1/16	26.97
12SL	1-3/8	34.93	1	25.40	1	25.40	3/4-20	1-1/16	26.97
12	1-13/64	30.56	1	25.40	1	25.40	5/8-24	1-1/16	26.97
14S	1-3/8	34.93	1-1/8	28.58	1	25.40	3/4-20	1-1/16	26.97
14	1-13/16	46.02	1-1/8	28.58	1	25.40	3/4-20	1-1/16	26.97
16S	1-1/2	38.10	1-1/4	31.75	1-1/8	28.58	7/8-20	1-5/16	33.32
16	1-15/16	49.20	1-1/4	31.75	1-1/8	28.58	7/8-20	1-5/16	33.32
18	1-15/16	49.20	1-11/32	34.11	1-1/8	28.58	1 -20	1-5/16	33.32
20	2-1/16	52.37	1-15/32	37.29	1-5/16	33.32	1-3/16-18	1-5/8	42.28
22	2-1/16	52.37	1-19/32	40.46	1-5/16	33.32	1-3/16-18	1-5/8	42.28
24	2-15/32	62.69	1-23/32	43.64	1-1/2	38.10	1-7/16-18	2	50.80
28	2-15/32	62.69	1-31/32	49.99	1-1/2	38.10	1-7/16-18	2	50.80

MS3108A angle plug

For use where space in front of panel or wall is at a premium. Swivel ring and plate combination allow cable take off at any angle relative to front shell polarizing key. Back shell is threaded for standard MS/AN fittings.

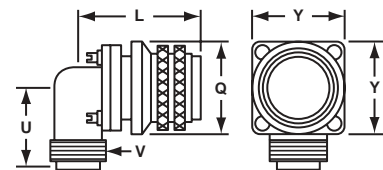

97 series solder type plugs with split shells

MS3106B

Connector Size	L Max.		Q Max.		V Fitting Threads	Y Ref.	
	Inch	mm	Inch	mm		Inch	mm
14S	1-11/16	42.85	1-1/8	28.58	3/4-20	1-5/32	29.36
16S	1-11/16	42.85	1-1/4	31.75	7/8-20	1-1/4	31.75
18	2-1/16	52.37	1-11/32	34.11	1 -20	1-41/64	41.66
20	2-1/8	53.98	1-15/32	37.29	1-3/16-18	1-13/16	46.02
22	2-1/8	53.98	1-19/32	40.46	1-3/16-18	1-15/16	49.20
24	2-9/32	57.94	1-23/32	43.64	1-7/16-18	2-1/16	52.37
28	2-9/32	57.94	1-31/32	49.99	1-7/16-18	2-5/16	58.72
32	2-5/16	58.72	2-7/32	56.34	1-3/4-18	2-19/32	65.86
36	2-11/32	59.51	2-15/32	62.69	2 -18	2-27/32	72.21

MS3106B straight plug

Used for unusual conduit applications where soldering and inspection is the prime requirement. Back shell is threaded for all standard MS/AN fittings.

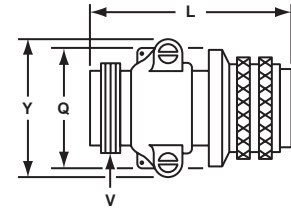

MS3107B

Connector Size	L Max.		Q Max.		V Fitting Threads	Y Ref.	
	Inch	mm	Inch	mm		Inch	mm
14S	1-11/16	42.85	1-1/8	28.58	3/4-20	1-5/32	29.36
16S	1-11/16	42.85	1-1/4	31.75	7/8-20	1-1/4	31.75
18	2-1/16	52.37	1-11/32	34.11	1 -20	1-41/64	41.66
20	2-1/8	53.99	1-15/32	37.29	1-3/16-18	1-13/16	46.02
22	2-1/8	53.99	1-19/32	40.46	1-3/16-18	1-15/16	49.20
24	2-9/32	57.94	1-23/32	43.64	1-7/16-18	2-1/16	52.37
28	2-9/32	57.94	1-31/32	49.99	1-7/16-18	2-5/16	58.72

MS3107B quick-disconnect plug

For fast connect/disconnect applications. Front shell has polarizing keyway. Mates with all types of MS receptacles. Back shell is threaded for standard MS/AN fittings.

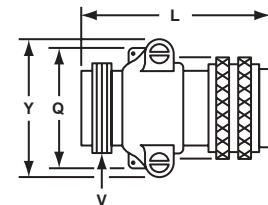

MS3108B

Connector Size	L Ref.		Q Max.		U Ref.		V Fitting Threads	X Ref.	
	Inch	mm	Inch	mm	Inch	mm		Inch	mm
10S	1-3/8	34.93	7/8	22.23	7/8	22.23	1/2-28		
10SL	1-1/2	38.10	7/8	22.23	1	25.40	5/8-24		
12S	1-9/16	39.67	1	25.40	1	25.40	5/8-24	1/2	12.70
12	1-7/8	47.63	1	25.40	1	25.40	5/8-24	1/2	12.70
14S	1-23/32	43.64	1-1/8	28.58	1-1/16	26.97	3/4-20	21/32	16.66
14	1-15/16	49.20	1-1/8	28.58	1-1/16	26.97	3/4-20	21/32	16.66
16S	1-3/4	44.45	1-1/4	31.75	1-1/8	28.58	7/8-20	1-1/2	38.10
16	2-1/8	53.98	1-1/4	31.75	1-1/8	28.58	7/8-20	1-1/2	38.10
18	2-5/32	54.75	1-11/32	34.11	1-3/16	30.15	1 -20	1-41/64	41.66
20	2-3/8	60.33	1-15/32	37.29	1-5/16	33.32	1-3/16-18	1-13/16	46.02
22	2-13/32	61.11	1-19/32	40.46	1-5/16	33.32	1-3/16-18	1-15/16	49.20
24	2-5/8	66.68	1-23/32	43.64	1-7/16	36.50	1-7/16-18	2-1/16	52.37
28	2-5/8	66.68	1-31/32	49.99	1-7/16	36.50	1-7/16-18	2-5/16	58.72
32	2-13/16	71.42	2-7/32	56.34	1-3/4	44.45	1-3/4-18	2-19/32	65.86
36	2-27/32	72.21	2-15/32	62.69	1-15/16	49.20	2 -18	2-27/32	72.21

MS3108B angle plug

Lightweight, roomy cavity, split longitudinally for convenient solder or inspection. Front shell is keyed to allow the 90° angle housing to be rotated and locked at any 45° increment.

Sizes 10S thru 14

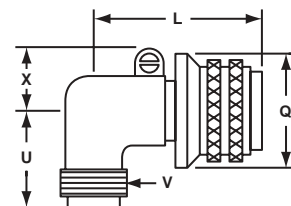

Sizes 16S thru 40

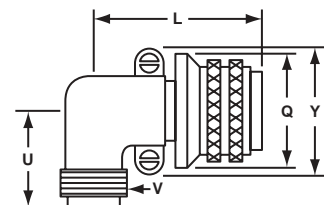

97 series solder type availability and weight reference

Insert Number	Wall Receptacles MS3100	Cable Receptacles MS3101	Box Receptacles MS3102	Straight Plugs MS3106		Quick Disconnect Plugs MS3107		Angle Plugs MS3108		Total Contacts
	Solid Shell	Solid Shell	Solid Shell	Solid Shell	Split Shell	Solid Shell	Split Shell	Solid Shell	Split Shell	
	A	A	A	A	B	A	B	A	B	
8S-1	.02	.01	.01	.02						1
10SL-3P	.03	.03	.02							3
10SL-3S				.03		.03		.06	.05	3
10SL-4P†	.02	.02	.02							2
10SL-4S†				.03		.03		.06	.05	2
12S-3	.04	.03	.03	.03		.03		.07	.07	2
12-5	.05	.04	.03	.06		.06		.09	.08	1
12S-6*	.04	.03	.03	.04		.04		.07	.08	2
12SL-844P*			.03							4
12SL-844S*				.05		.06		.08		4
14S-1†	.05	.04	.03	.06	.06	.06	.06	.08	.08	3
14S-2	.05	.04	.03	.06	.06	.06	.06	.08	.08	4
14S-4†	.05	.04	.03	.06	.06	.06	.06	.08	.08	1
14S-5	.05	.04	.04	.06	.06	.06	.06	.08	.08	5
14S-6	.05	.04	.04	.06	.06	.06	.06	.08	.08	6
14S-7	.05	.04	.03	.06	.06	.06	.06	.08	.08	3
14S-9†	.05	.04	.03	.06	.06	.07	.06	.08	.08	2
16S-1	.06	.05	.05	.07	.07	.08	.07	.14	.11	7
16S-4	.06	.05	.04	.07	.07	.07	.07	.12	.10	2
16S-5†	.06	.05	.04	.07	.07	.07	.07	.12	.10	3
16S-6†	.06	.05	.04	.07	.07	.09	.07	.12	.10	3
16-7	.08	.08	.07	.09		.07		.15	.14	3
16S-8	.06	.05	.04	.07	.07	.09	.07	.12	.10	5
16-9	.08	.07		.09		.09	.10	.12	.13	4
16-10	.08	.08	.07	.09		.09		.15	.14	3
16-11†	.08	.07	.07	.09		.11		.14	.13	2
16-12	.10	.09	.08	.11		.08		.16	.15	1
16-13	.07	.07	.06	.08		.11		.14	.13	2
18-1	.10	.10	.08	.11	.13	.12	.13	.16	.15	10
18-3†	.10	.10	.08	.12	.13	.11	.13	.16	.15	2
18-4	.09	.09	.07	.11	.13	.12	.13	.16	.15	4
18-5	.10	.10	.08	.12	.13	.13	.13	.16	.15	3
18-8	.10	.10	.08	.12	.14	.12	.14	.16	.15	8
18-9	.11	.10	.09	.12	.14	.13	.14	.17	.16	7
18-10†	.11		.09	.13	.14	.13	.14	.17	.16	4
18-11	.11	.11	.09	.13	.15	.11	.15	.18	.17	5
18-12†	.10	.09	.08	.11	.13	.13	.13	.16	.15	6
18-13	.12	.12	.10	.13	.15	.13	.15	.18	.17	4
18-16	.09	.09	.07	.11	.13	.11	.13	.15	.14	1
18-19†	.10	.10	.08	.11	.13	.11	.13	.16	.15	10
18-20†	.09	.09	.07	.11	.13	.11	.13	.15	.15	5
18-22†	.09	.09	.07	.11	.13		.13	.16	.15	3
18-29†	.10		.08	.11	.13	.11	.13	.16	.15	5
18-420†*	.10	.10	.08	.12	.13	.12	.13	.16	.16	1
20-3†	.14	.13	.10	.15	.16	.15	.16	.24	.19	3

Where no weight is shown, insert is not available in that shell type.

† Inactive for new military design, but available for replacement or for non-military purposes.

* "MS" number not assigned. Use "97" prefix in place of "MS" in completing catalog number.

Weights are for connectors with socket contacts.

Connectors with pin contacts weigh slightly less.

If a weight appears in the column, the shell is available.

Weight is shown in lbs.

97 series solder type availability and weight reference, cont.

Insert Number	Wall Receptacles MS3100	Cable Receptacles MS3101	Box Receptacles MS3102	Straight Plugs MS3106		Quick Disconnect Plugs MS3107		Angle Plugs MS3108		Total Contacts
	Solid Shell	Solid Shell	Solid Shell	Solid Shell	Split Shell	Solid Shell	Split Shell	Solid Shell	Split Shell	
	A	A	A	A	B	A	B	A	B	
20-4	.14	.13	.10	.15	.16	.15	.16	.24	.19	4
20-6†	.12	.11	.09	.13	.15	.14	.15	.23	.18	3
20-7	.13	.12	.09	.14	.15	.14	.15	.23	.18	8
20-8	.15	.14	.12	.16	.18	.16	.18	.26	.20	6
20-11†	.14	.13	.11	.15	.17	.15	.17	.25	.20	13
20-14	.16	.15	.13	.17	.19	.17	.19	.27	.21	5
20-15	.15	.14	.12	.16	.18	.16	.18	.26	.21	7
20-16	.14	.13	.10	.15	.16	.15	.16	.24	.19	9
20-17	.15	.14	.11	.16	.17	.16	.17	.25	.20	6
20-18	.14	.13	.11	.15	.17	.15	.17	.25	.19	9
20-19†	.16	.15	.13	.17	.19	.17	.19	.27	.21	3
20-21	.13	.12	.10	.14	.16	.14	.16	.24	.19	9
20-23†	.15	.14	.11	.16	.17	.16	.17	.25	.20	2
20-24	.15	.14	.11	.16	.17	.16	.17	.25	.20	4
20-27	.13	.12	.10	.14	.16	.14	.16	.24	.19	14
20-29	.14	.13	.11	.15	.17	.15	.17	.25	.20	17
20-33	.13	.12	.09	.14	.18	.18	.18	.23	.18	11
22-1†	.16	.16	.13	.18	.19	.18	.19	.27	.23	2
22-2	.17	.17	.14	.19	.20	.19	.20	.29	.24	3
22-4†	.21	.17	.14	.19	.20	.19	.20	.28	.23	4
22-5	.15	.14	.12	.17	.18	.17	.18	.26	.21	6
22-8†	.15	.14	.11	.16	.18	.16	.18	.26	.21	2
22-9	.15	.15	.12	.17	.18	.17	.18	.26	.21	3
22-10	.14	.13	.10	.15	.17	.15	.17	.25	.20	4
22-11	.14	.13	.10	.15	.17	.15	.17	.25	.20	2
22-12	.16	.16	.13	.18	.19	.18	.19	.27	.23	5
22-13†	.16	.15	.12	.17	.18	.17	.18	.27	.22	5
22-14	.15	.14	.11	.16	.18	.16	.18	.26	.21	19
22-15	.16	.14	.13	.17	.19	.17	.19	.27	.22	6
22-16†	.16	.15	.12	.17	.18	.17	.18	.27	.22	9
22-18	.14	.13	.10	.15	.17	.15	.17	.25	.20	8
22-19	.15	.14	.11	.16	.18	.16	.18	.26	.21	14
22-20†	.14	.14	.11	.16	.17	.16	.17	.25	.21	9
22-22	.19	.19	.16	.21	.26	.21	.22	.30	.25	4
22-23	.17	.16	.13	.18	.20	.18	.20	.28	.23	8
22-26†	.15	.14	.11						.19	7
22-27	.15	.15	.12	.17	.18	.17	.18	.27	.22	9
22-28†	.17	.16	.13	.18	.20	.18	.20	.28	.23	7
22-34†	.15	.15	.12	.17	.18	.17	.18	.26	.22	5
24-2	.20	.19	.16	.22	.24	.22	.24	.39	.29	7
24-5†	.18	.17	.14	.20	.22	.20	.22	.37	.27	16
24-6	.20	.19	.16	.22	.24	.22	.27	.39	.29	8
24-7	.19	.18	.14	.21	.23	.21	.23	.38	.27	16
24-9†	.22	.21	.17	.24	.25	.24	.25	.41	.30	2
24-10	.26	.25	.21	.28	.30	.28	.30	.45	.34	7

Where no weight is shown, insert is not available in that shell type.

† Inactive for new military design, but available for replacement or for non-military purposes.

* "MS" number not assigned. Use "97" prefix in place of "MS" in completing catalog number.

Weights are for connectors with socket contacts. Connectors with pin contacts weigh slightly less. If a weight appears in the column, the shell is available. Weight is shown in lbs.

97 series solder type availability and weight reference, cont.

Insert Number	Wall Receptacles MS3100	Cable Receptacles MS3101	Box Receptacles MS3102	Straight Plugs MS3106		Quick Disconnect Plugs MS3107		Angle Plugs MS3108		Total Contacts
	Solid Shell	Solid Shell	Solid Shell	Solid Shell	Split Shell	Solid Shell	Split Shell	Solid Shell	Split Shell	
	A	A	A	A	B	A	B	A	B	
24-11	.24	.22	.19	.26	.27	.26	.27	.43	.32	9
24-12	.23	.22	.19	.25	.27	.25	.27	.42	.32	5
24-16	.20	.19	.15	.22	.24	.22	.24	.39	.28	7
24-19†	.18	.17	.13	.20	.22			.37	.36	12
24-20	.19	.17	.14	.21	.22	.21	.22	.38	.27	11
24-21	.19	.17	.14	.21	.23	.21	.23	.38	.27	10
24-22	.22	.21	.18	.24	.26	.24	.26	.41	.30	4
24-27	.17	.16	.13	.20	.21	.20	.21	.36	.26	7
24-28	.19	.18	.14	.21	.22	.21	.22	.38	.27	24
28-1	.29	.27	.24	.30	.32	.30	.32	.44	.36	9
28-2	.24	.22	.19	.25	.27	.25	.27	.40	.32	14
28-3	.26	.24	.21	.28	.30	.28	.30	.42	.34	3
28-6†	.30	.28	.25	.31	.33	.31	.33	.45	.38	3
28-8	.23	.22	.18	.25	.27	.25	.27	.39	.31	12
28-9	.25	.24	.20	.27	.29	.27	.29	.41	.33	12
28-10	.31	.29	.26	.33	.35	.33	.35	.47	.39	7
28-11	.25	.24	.20	.27	.29	.27	.29	.41	.33	22
28-12	.24	.22	.19	.26	.28	.26	.28	.40	.32	26
28-15†	.25	.23	.20	.26	.28	.26	.28	.40	.32	35
28-16†	.24	.22	.19	.25	.27	.25	.27	.39	.31	20
28-17	.23	.22	.18	.25	.27	.25	.27	.39	.31	15
28-18	.23	.22	.18	.25	.27	.25	.27	.39	.31	12
28-19	.24	.22	.19	.26	.28	.26	.28	.40	.32	10
28-20	.27	.25	.22	.29	.31	.29	.31	.43	.35	14
28-21	.25	.23	.20	.26	.28	.26	.28	.40	.32	37
32-5†	.36	.35	.32	.38	.40				.48	2
32-6	.39	.38	.35	.41	.43				.51	23
32-7	.33	.33	.29	.36	.38				.45	35
32-8†	.32	.32	.29	.35	.37				.44	30
32-13	.32	.31	.28	.34	.36				.44	23
32-17	.37	.37	.34	.40	.42				.49	4
32-414†	.35	.35	.31	.38	.40				.48	52
36-1†	.41	.39	.34	.41	.43				.52	22
36-5	.54	.52	.47	.54	.56				.65	4
36-6	.55	.53	.49	.55	.57				.67	6
36-7	.44	.41	.37	.44	.45				.55	47
36-8	.40	.38	.34	.41	.42				.52	47
36-9	.50	.47	.43	.50	.51				.61	31
36-10	.41	.39	.34	.41	.43				.53	48
36-15	.40	.37	.38	.40	.41				.51	35
36-403†*	.40	.36	.33	.40	.41				.51	52

Where no weight is shown, insert is not available in that shell type.

† Inactive for new military design, but available for replacement or for non-military purposes.

* "MS" number not assigned. Use "97" prefix in place of "MS" in completing catalog number.

Weights are for connectors with socket contacts. Connectors with pin contacts weigh slightly less. If a weight appears in the column, the shell is available. Weight is shown in lbs.

97 series solder type how to order

Example of part number for solder type connectors is given below.

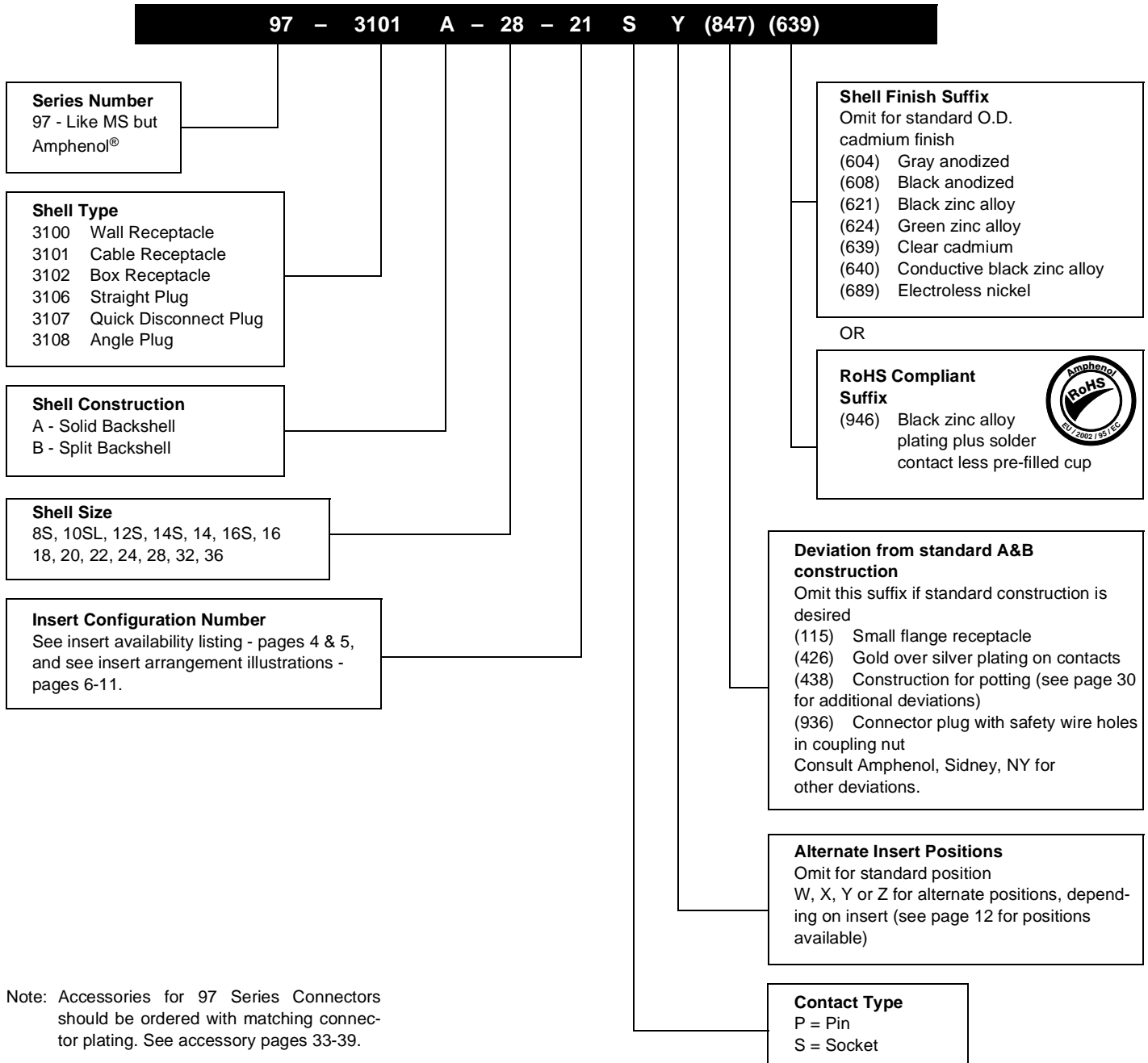

Note: Accessories for 97 Series Connectors should be ordered with matching connector plating. See accessory pages 33-39.

Amphenol® 97 Series Connectors with rear release crimp contacts



DESIGN CHARACTERISTICS

- Rugged metal shell
- Conductive finish
- Stamped & formed crimp contacts
- Closed entry socket contacts
- Plastic retention
- Utilizes standard 97 Series hardware
- Intermateable and intermountable with existing 97 Series and MIL-5015 connectors
- Underwriters Laboratories approved recognition File E115497
- Canadian Standards Association Certification File LR69183

CUSTOMER OPTIONS

- Positive self-centering of contacts; pins bent up to 20° will pick up
- Reduced user cost due to high speed termination
- Less equipment down-time due to fatigue failure at wire contact junction or handling damage
- Greater contact to contact insulation, lighter weight, higher reliability
- No costly re-design or rework necessary on existing equipment
- Complete flexibility through multi-source product availability

The Amphenol 97-410X connector design incorporates Poke Home® Rear Release contacts. The 97 Series Rear Release line is intermateable and intermountable with existing 97 Series and MIL-5015 type shell styles in both plugs and receptacles. The connectors utilize 97 Series bright cadmium plated shells and standard insert configurations.

The connector is designed to be used with stamped and formed type crimp contacts. Contact design (size 16 only) incorporates insulation crimp support for greater strength at wire termination end. Contacts are available on reel assemblies for use with the high speed Amphenol stripper crimper capable of crimping 1500 contacts per hour. Hand crimp tools and bulk packaged contacts are also available.

Standard hardware available for the 97 Series connector can be used with the 97 Series crimp contact rear release line. Accessories should be ordered with the appropriate deviation number to match the bright cadmium connector finish. See how to order, page 27, for 97 Series connectors with crimp contacts.

97 series crimp type specifications, insert availability, alternate insert positioning

Specifications

Standard shell finish - clear chromate over cadmium plate (optional plating available, see how to order page 27).

Inserts - molded of a 94V-O Underwriters Laboratory rated material.

Contacts - copper alloy formed, silver plated (gold plating is also available, see how to order page 28).

Wire sizes - 12 AWG through 30 AWG.

All constructions perform satisfactorily from -55°C to $+125^{\circ}\text{C}$ (-67°F to $+257^{\circ}\text{F}$).

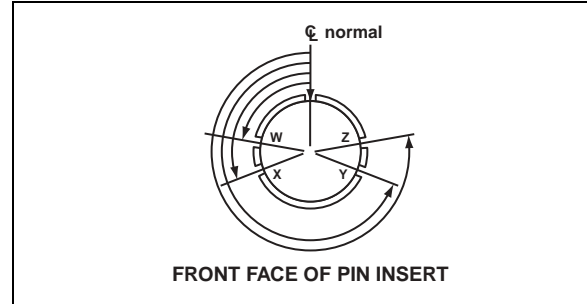

Insert Availability

Insert Number	Total Contacts	Mechanical Spacing		Service Rating	Contact Size	
		Inches	mm		12	16
10SL-3	3	1/16	1.57	A		3
10SL-4	2	1/16	1.57	A		2
12S-3	2	1/16	1.57	A		2
14S-1	3	1/16	1.57	A		3
14S-2	4			INST.		4
14S-5	5			INST.		5
14S-7	3	1/16	1.57	A		3
16S-1	7	1/16	1.57	A		7
16S-8	5	1/16	1.57	A		5
18-1	10	1/16	1.57	A		4
				INST.		6
18-4	4	1/8	3.18	D		4
18-11	5	1/16	1.57	A	5	
18-12	6	1/16	1.57	A		6
18-19	10	1/16	1.57	A		10
18-20	5	1/16	1.57	A		5
20-4	4	1/8	3.18	D	4	
20-7	8	1/8	3.18	D		4
		1/16	1.57	A		4
20-27	14	1/16	1.57	A		14
20-29	17	1/16	1.57	A		17
22-14	19	1/16	1.57	A		19
24-2	7	1/8	3.18	D	7	
28-11	22	1/16	1.57	A	4	18
28-12	26	1/16	1.57	A		26
28-20	14	1/16	1.57	A	10	4
28-21	37	1/16	1.57	A		37
32-414	52	1/16	1.57	A		52
36-10	48	1/16	1.57	A		48

Alternate Insert Positioning

Insert Arrangement	Degrees			
	W	X	Y	Z
12S-3	70	145	215	290
14S-2	-	120	240	-
14S-5	-	110	-	-
14S-7	90	180	270	-
16S-1	80	-	-	280
16S-8	-	170	265	-
18-1	70	145	215	290
18-4	35	110	250	325
18-11	-	170	265	-
18-12	80	-	-	280
18-19	-	120	240	-
18-20	90	180	270	-
20-4	45	110	250	-
20-7	80	110	250	280
20-27	35	110	250	325
20-29	80	-	-	280
22-14	80	-	-	280
24-2	80	-	-	280
28-9	80	110	250	280
28-11	80	110	250	280
28-12	90	180	270	-
28-20	80	110	250	280
28-21	80	110	250	280
32-8	80	125	235	280
32-414*	80*	110*	250*	280*
36-10	80	125	235	280

* Rotates opposite above illustration.

97 series crimp type insert arrangements

Front view of pin insert or rear of socket insert illustrated.

2 Contacts

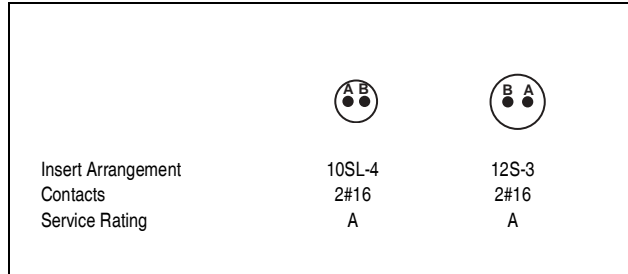

3 Contacts

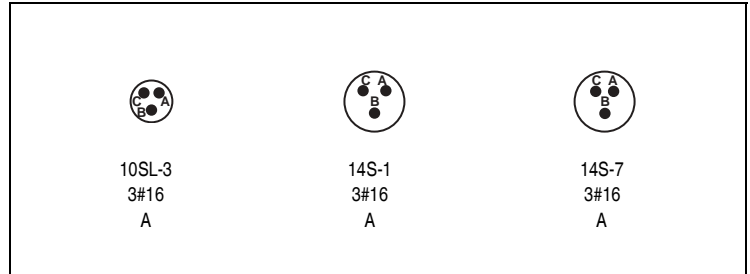

4 Contacts

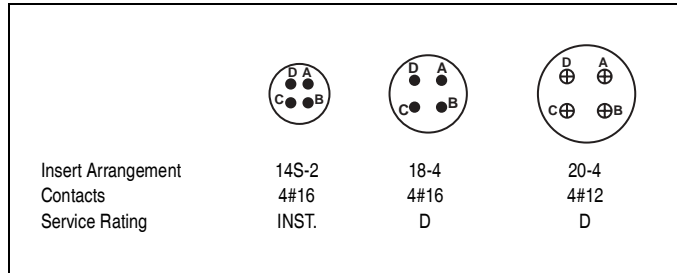

5 Contacts

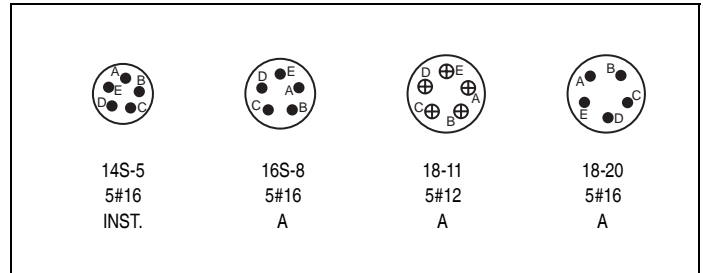

6 Contacts

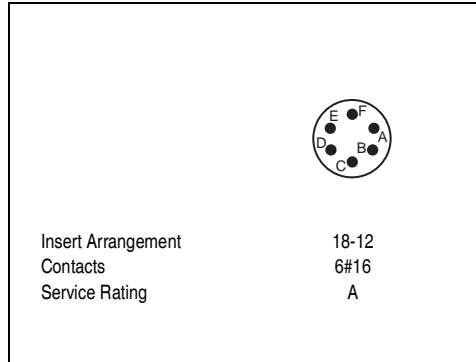

7 Contacts

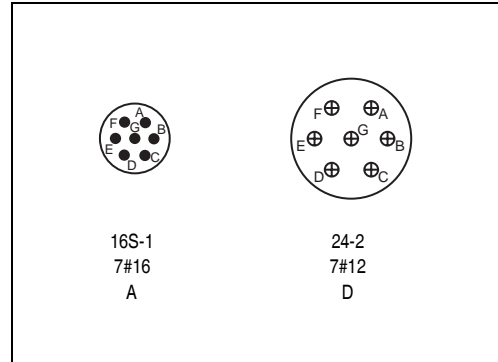

8 Contacts

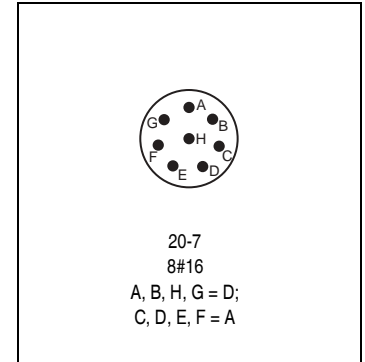

10 Contacts

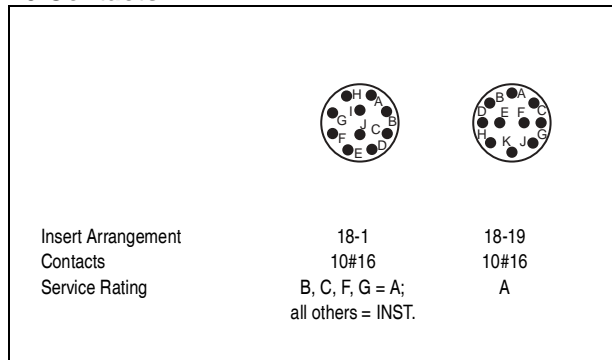

14 Contacts

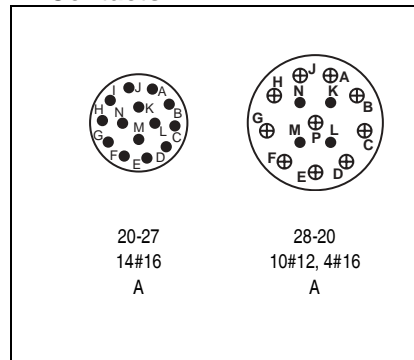

17 Contacts

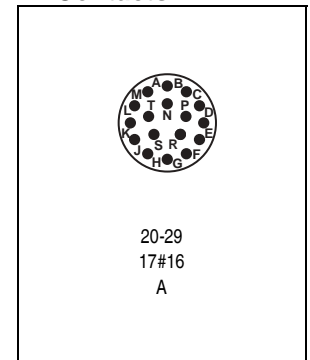

97 series crimp type insert arrangements, cont.

Front view of pin insert or rear of socket insert illustrated.

19 Contacts

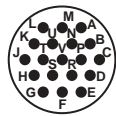

Insert Arrangement 22-14
 Contacts 19#16
 Service Rating A

22 Contacts



 28-11
 4#12, 18#16
 A

26 Contacts

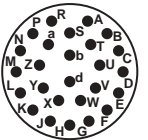

 28-12
 26#16
 A

37 Contacts

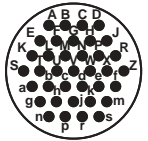

Insert Arrangement 28-21
 Contacts 37#16
 Service Rating A

48 Contacts

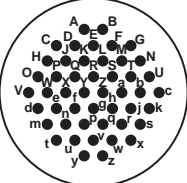

 36-10
 48#16
 A

52 Contacts

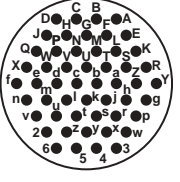

 32-414
 52#16
 A

CONTACT LEGEND

●	⊕
16	12

Current Ratings

Wire Size	12	14	16	18	20	22	26	28	30
Amperes	23	17	13	10	7.5	5	2	1.5	1.0

NOTE: Design specifications subject to change.
 Consult Amphenol, Sidney, NY for the latest specifications
 and UL and CSA recognition.

Service Rating

Service Rating	Recommended Operating Voltage* at Sea Level	
	DC	AC (RMS)
INST.	250	200
A	700	500
D	1250	900

* The values listed represent operating values which include a generous safety factor.

97 series crimp type receptacles

97-4100A wall mount receptacle

Solid shell construction is strong and conserves space. Includes integral polarizing key in front. Back shell is threaded for standard MS/AN fittings.

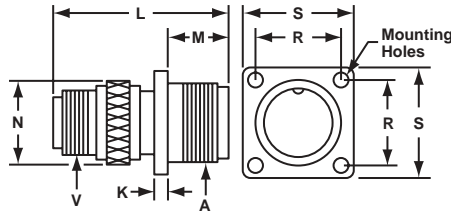

97-4101A cable receptacle

Solid shell construction is strong and conserves space. Includes integral polarizing key in front shell. Machined back shell is threaded for standard MS/AN fittings. Can be unscrewed for inspection or soldering

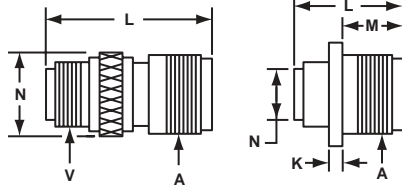

97-4102A box receptacle

Solid shell designed for open wiring. Mounts directly on chassis, equipment or panel. Includes internal polarized key in front shell.

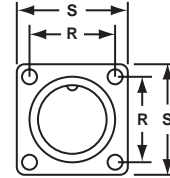

Mounting Holes
 .173 (4.394) DIA.
 FOR SIZE 32 AND 36
 .147 (3.734) DIA.
 FOR SIZES 24 AND 28
 .120 (3.048) DIA.
 FOR ALL OTHER SIZES

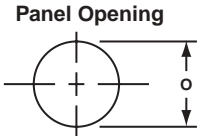

97-4100A and 97-4101A

Connector Size	A Coupling Thread	K Ref.		L Max.		M Ref.		N Ref.		O Ref.		R Ref.		S Ref.		V Fitting Threads
		Inch	mm	Inch	mm	Inch	mm	Inch	mm	Inch	mm	Inch	mm	Inch	mm	
10SL	5/8-24	5/64	1.98	1-9/32	32.53	9/16	14.27	3/4	19.05	.812	20.62	23/32	18.24	1	25.40	5/8-24
12S	3/4-20	5/64	1.98	1-15/32	37.29	9/16	14.27	25/32	19.84	.812	20.62	13/16	20.62	1-3/32	27.76	5/8-24
14S	7/8-20	5/64	1.98	1-15/32	37.39	9/16	14.27	7/8	22.23	.938	23.83	29/32	23.01	1-3/16	30.15	3/4-20
16S	1 -20	5/64	1.98	1-15/32	37.39	9/16	14.27	1	25.40	1.062	26.97	31/32	24.59	1-9/32	32.54	7/8-20
18	1-1/8-18	1/8	3.18	1-63/64	50.24	3/4	19.05	1-1/8	28.58	1.188	30.18	1-1/16	26.97	1-3/8	34.93	1 -20
20	1-1/4-18	1/8	3.18	1-57/64	47.85	3/4	19.05	1-1/4	31.75	1.312	33.32	1-5/32	29.36	1-1/2	38.10	1-3/16-18
22	1-3/8-18	1/8	3.18	1-63/64	50.24	3/4	19.05	1-3/8	34.93	1.438	36.53	1-1/4	31.75	1-5/8	39.67	1-3/16-18
24	1-1/2-18	1/8	3.18	2-14	57.15	13/16	20.62	1-1/2	38.10	1.562	36.67	1-3/8	34.43	1-3/4	44.45	1-7/16-18
28	1-3/4-18	1/8	3.18	2-1/4	57.15	13/16	20.62	1-3/4	44.45	1.812	46.02	1-9/16	39.67	2	50.80	1-7/16-18
32	2 -18	1/8	3.18	2-3/8	60.33	7/8	22.23	2-1/32	51.59	2.062	52.37	1-3/4	44.45	2-1/4	57.15	1-3/4-18
36	2-1/4-16	1/8	3.18	2-3/8	60.33	7/8	22.23	2-1/4	57.15	2.312	58.72	1-15/16	49.20	2-1/2	63.50	2 -18

97-4102A

Connector Size	A Coupling Thread	K Ref.		L Max.		M Ref.		N Ref.		O Ref.		R Ref.		S Ref.	
		Inch	mm	Inch	mm	Inch	mm	Inch	mm	Inch	mm	Inch	mm	Inch	mm
10SL	5/8-24	5/64	1.98	61/64	24.21	35/64	13.87	11/16	17.48	.812	20.62	23/32	18.24	1	25.40
12S	3/4-20	5/64	1.98	31/32	24.61	9/16	14.27	11/16	17.45	.812	20.62	13/16	20.62	1-3/32	27.76
14S	7/8-20	5/64	1.98	61/64	24.21	9/16	14.27	3/4	19.05	.938	23.83	29/32	23.01	1-3/16	30.15
16S	1 -20	5/64	1.98	61/64	24.21	9/16	14.27	7/8	22.23	1.062	26.97	31/32	24.59	1-9/32	32.54
18	1-1/8-18	1/8	3.18	1-3/8	34.92	3/4	19.05	1	25.40	1.188	30.18	1-1/16	26.97	1-3/8	34.93
20	1-1/4-18	1/8	3.18	1-3/8	34.92	3/4	19.05	1-1/8	28.58	1.312	33.32	1-5/32	29.36	1-1/2	38.10
22	1-3/8-18	1/8	3.18	1-3/8	34.92	3/4	19.05	1-1/4	31.75	1.438	36.53	1-1/4	31.75	1-5/8	41.28
24	1-1/2-18	1/8	3.18	1-3/8	34.92	13/16	20.62	1-3/8	34.93	1.562	39.67	1-3/8	34.93	1-3/4	44.45
28	1-3/4-18	1/8	3.18	1-3/8	34.92	13/16	20.62	1-5/8	41.28	1.812	46.02	1-9/16	39.67	2	50.80
32	2 -18	1/8	3.18	1-15/32	37.31	7/8	22.23	1-29/32	48.41	2.062	52.37	1-3/4	44.45	2-1/4	57.15
36	2-1/4-16	1/8	3.18	1-15/32	37.31	7/8	22.23	2-1/8	53.98	2.312	58.72	1-15/16	49.20	2-1/2	63.50

97 series crimp type plugs with solid shells

97-4106A

Connector Size	L Max.		N Ref.		Q Max.		V Fitting Threads
	Inch	mm	Inch	mm	Inch	mm	
10SL	1-3/8	34.93	3/4	19.05	7/8	22.23	5/8-24
12S	1-7/16	36.50	25/32	19.84	1	25.40	5/8-24
14S	1-15/32	37.13	7/8	22.23	1-1/8	28.58	3/4-20
16S	1-15/32	37.13	1	25.40	1-1/4	31.75	7/8-20
18	1-31/32	49.88	1-1/8	28.57	1-11/32	34.11	1 -20
20	1-7/8	47.50	1-1/4	31.75	1-15/32	37.29	1-3/16-18
22	1-31/32	49.88	1-3/8	34.93	1-19/32	40.46	1-3/16-18
24	2-1/4	57.15	1-1/2	38.10	1-23/32	43.64	1-7/16-18
28	2-1/4	57.15	1-3/4	44.45	1-31/32	49.99	1-7/16-18
32	2-3/8	60.33	2-1/32	51.59	2-7/32	56.34	1-3/4-18
36	2-3/8	60.33	2-1/4	57.15	2-15/32	62.69	2 -18

97-4106A straight plug

Sturdy, simple to assemble. Coupling ring machined from solid aluminum bar stock for high tensile strength. Mates with all types of MS receptacles. Front shell includes polarizing keyway. Back shell is threaded for standard MS/AN fittings.

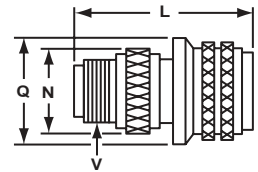

97-4107A

Connector Size	L Max.		N Ref.		Q Max.		V Fitting Threads
	Inch	mm	Inch	mm	Inch	mm	
10SL	1-3/8	34.92	3/4	19.05	7/8	22.23	5/8-24
12S	1-7/16	36.50	25/32	19.84	1	25.40	5/8-24
14S	1-15/32	37.13	7/8	22.23	1-1/8	38.58	3/4-20
16S	1-15/32	37.13	1	25.40	1-1/4	31.75	7/8-20
16	1-7/8	47.47	1	25.40	1-1/4	31.75	7/8-20
18	1-31/32	49.88	1-1/8	28.58	1-11/32	34.11	1 -20
20	1-7/8	47.50	1-1/4	31.75	1-15/32	37.29	1-3/16-18
22	1-31/32	49.88	1-3/8	34.93	1-19/32	40.46	1-3/16-18
24	2-1/4	57.15	1-1/2	38.10	1-23/32	43.64	1-7/16-18
28	2-1/4	57.15	1-3/4	44.45	1-31/32	49.99	1-7/16-18

97-4107A quick-disconnect plug

For fast connect/disconnect applications. Front shell has polarizing keyway. Mates with all types of MS receptacles. Back shell is threaded for standard MS/AN fittings.

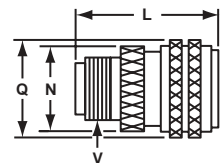

97-4108A

Connector Size	L Ref.		Q Max.		U Ref.		V Fitting Threads	Y Ref.	
	Inch	mm	Inch	mm	Inch	mm		Inch	mm
10SL	1-5/16	33.32	7/8	22.23	1	25.40	5/8-24	1-1/16	26.97
12S	1-3/8	34.93	1	25.40	1	25.40	5/8-24	1-1/16	26.97
14S	1-3/8	34.93	1-1/8	28.58	1	25.40	3/4-20	1-1/16	26.97
16S	1-1/2	38.10	1-1/4	31.75	1-1/8	28.58	7/8-20	1-5/16	33.32
18	1-15/16	49.20	1-11/32	34.11	1-1/8	28.58	1 -20	1-5/16	33.32
20	2-1/16	52.37	1-15/32	37.29	1-5/16	33.32	1-3/16-18	1-5/8	42.28
22	2-1/16	52.37	1-19/32	40.46	1-5/16	33.32	1-3/16-18	1-5/8	42.28
24	2-15/32	62.69	1-23/32	43.64	1-1/2	38.10	1-7/16-18	2	50.80
28	2-15/32	62.69	1-31/32	49.99	1-1/2	38.10	1-7/16-18	2	50.80

97-4108A angle plug

For use where space in front of panel or wall is at a premium. Swivel ring and plate combination allow cable take off at any angle relative to front shell polarizing key. Back shell is threaded for standard MS/AN fittings.

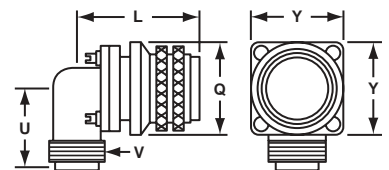

97 series crimp type plugs with split shells

97-4106B

Connector Size	L Max.		Q Max.		V Fitting Threads	Y Ref.	
	Inch	mm	Inch	mm		Inch	mm
14S	1-11/16	42.85	1-1/8	28.58	3/4-20	1-5/32	29.36
16S	1-11/16	42.85	1-1/4	31.75	7/8-20	1-1/4	31.75
18	2-1/16	52.37	1-11/32	34.11	1 -20	1-41/64	41.66
20	2-1/8	53.98	1-15/32	37.29	1-3/16-18	1-13/16	46.02
22	2-1/8	53.98	1-19/32	40.46	1-3/16-18	1-15/16	49.20
24	2-9/32	57.94	1-23/32	43.64	1-7/16-18	2-1/16	52.37
28	2-9/32	57.94	1-31/32	49.99	1-7/16-18	2-5/16	58.72
32	2-5/16	58.72	2-7/32	56.34	1-3/4-18	2-19/32	65.86
36	2-11/32	59.51	2-15/32	62.69	2 -18	2-27/32	72.21

97-4106B straight plug

Used for unusual conduit applications where soldering and inspection is the prime requirement. Back shell is threaded for all standard MS/AN fittings.

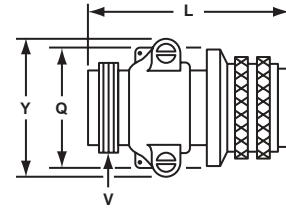

97-4107B

Connector Size	L Max.		Q Max.		V Fitting Threads	Y Ref.	
	Inch	mm	Inch	mm		Inch	mm
14S	1-11/16	42.85	1-1/8	28.58	3/4-20	1-5/32	29.36
16S	1-11/16	42.85	1-1/4	31.75	7/8-20	1-1/4	31.75
18	2-1/16	52.37	1-11/32	34.11	1 -20	1-41/64	41.66
20	2-1/8	53.99	1-15/32	37.29	1-3/16-18	1-13/16	46.02
22	2-1/8	53.99	1-19/32	40.46	1-3/16-18	1-15/16	49.20
24	2-9/32	57.94	1-23/32	43.64	1-7/16-18	2-1/16	52.37
28	2-9/32	57.94	1-31/32	49.99	1-7/16-18	2-5/16	58.72

97-4107B quick-disconnect plug

For fast connect/disconnect applications. Front shell has polarizing keyway. Mates with all types of MS receptacles. Back shell is threaded for standard MS/AN fittings.

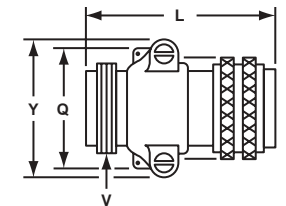

97-4108B

Connector Size	L Ref.		Q Max.		U Ref.		V Fitting Threads	X Ref.	
	Inch	mm	Inch	mm	Inch	mm		Inch	mm
10SL	1-1/2	38.10	7/8	22.23	1	25.40	5/8-24		
12S	1-9/16	39.67	1	25.40	1	25.40	5/8-24	1/2	12.70
14S	1-23/32	43.64	1-1/8	28.58	1-1/16	26.97	3/4-20	21/32	16.66
16S	1-3/4	44.45	1-1/4	31.75	1-1/8	28.58	7/8-20	1-1/2	38.10
18	2-5/32	54.75	1-11/32	34.11	1-3/16	30.15	1 -20	1-41/64	41.66
20	2-3/8	60.33	1-15/32	37.29	1-5/16	33.32	1-3/16-18	1-13/16	46.02
22	2-13/32	61.11	1-19/32	40.46	1-5/16	33.32	1-3/16-18	1-15/16	49.20
24	2-5/8	66.68	1-23/32	43.64	1-7/16	36.50	1-7/16-18	2-1/16	52.37
28	2-5/8	66.68	1-31/32	49.99	1-7/16	36.50	1-7/16-18	2-5/16	58.72
32	2-13/16	71.42	2-7/32	56.34	1-3/4	44.45	1-3/4-18	2-19/32	65.86
36	2-27/32	72.21	2-15/32	62.69	1-15/16	49.20	2 -18	2-27/32	72.21

97-4108B angle plug

Lightweight, roomy cavity, split longitudinally for convenient inspection. Front shell is keyed to allow the 90° angle housing to be rotated and locked at any 45° increment.

Sizes 10SL thru 14S

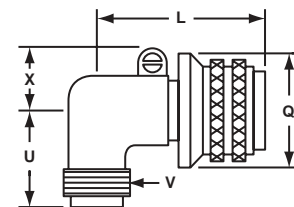

Sizes 16S thru 36

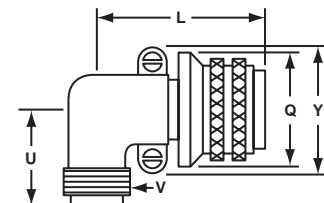

97 series crimp type how to order

Example of part number for crimp type connectors is given below.

97 - 4101 A - 28 - 21 S Y (621)

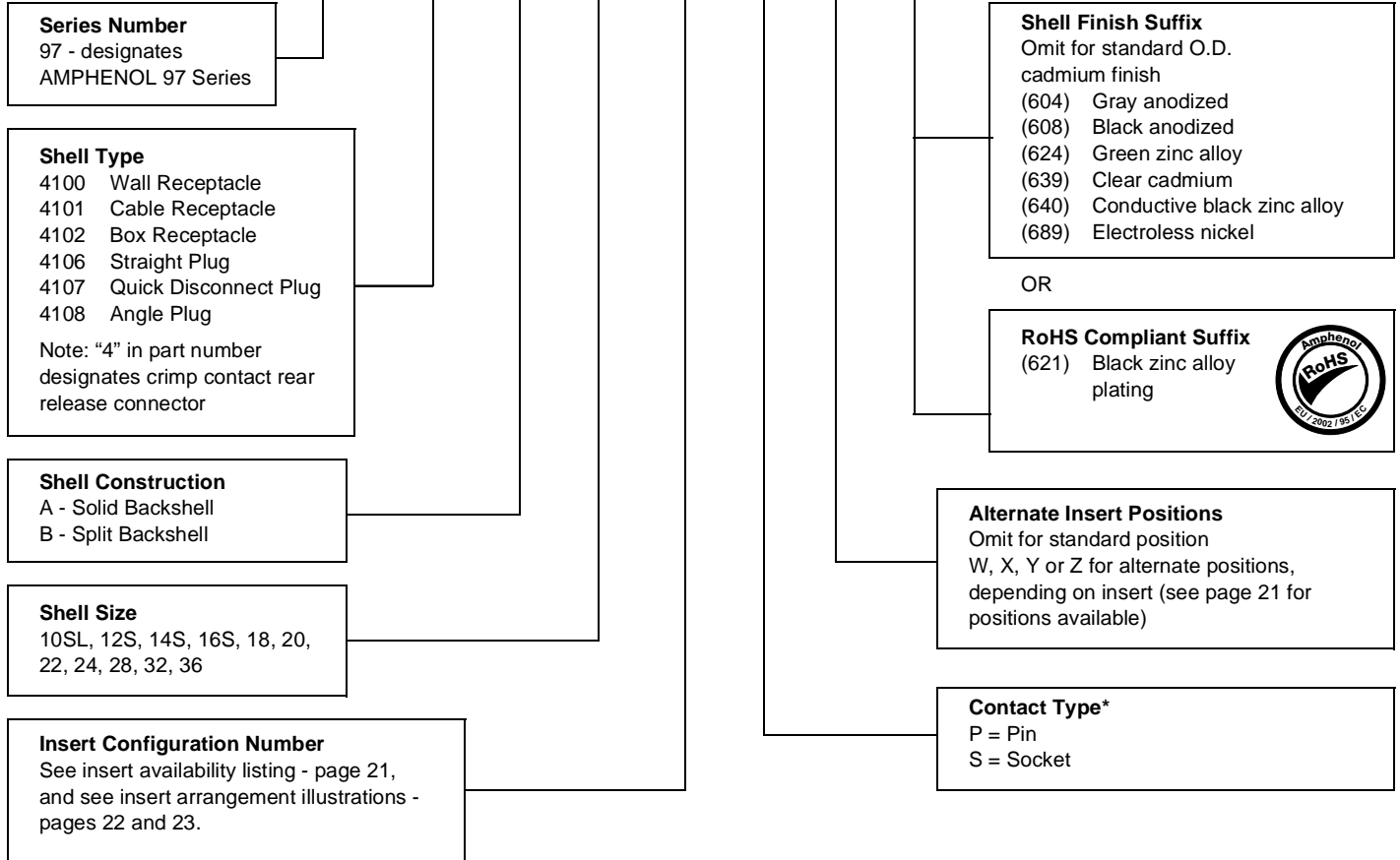

* Contacts are not supplied with connectors, and must be ordered separately. See following pages for contact information.

Note:
Accessories for 97 Series Connectors should be ordered with matching connector plating. See accessory pages 33-39.

97 series crimp type contact information

Crimp contacts can be ordered for 97 Series connectors in reel assemblies or in bulk packaging. Order by part numbers given below:

Reel Assembly - For use with semi-automatic crimping equipment; order number of reels required.

Reel Assemblies Available

Part Number	Size	For Connector Sizes
9738-1216P-X250	12	18 thru 36
9738-1216S-X250	12	18 thru 36
9745-1418P-X400	16	10SL thru 36
9745-1418S-X400	16	18 thru 36
9755-1418S-X400	16	10SL thru 16S only
9745-1622P-X400	16	10SL thru 36
9755-1622S-X400	16	10SL, 12S, 14S, 16S only
9745-1622S-X400	16	18 thru 36
9745-2026P-X400	16	10SL thru 36
9755-2026S-X400	16	10SL, 12S, 14S, 16S only
9745-2026S-X400	16	18 thru 36
9745-2630P-X400	16	10SL thru 36
9755-2630S-X400	16	10SL, 12S, 14S, 16S only
9745-2630S-X400	16	18 thru 36

Example of part number:

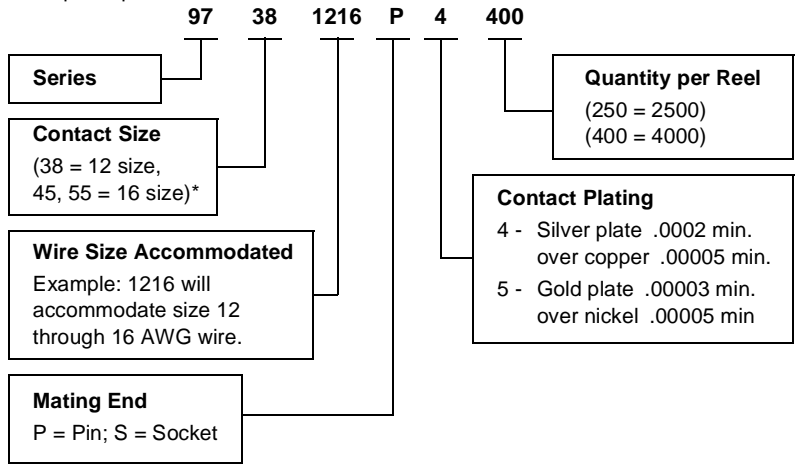

Bulk Packaged Contacts Available

Part Number	Size	For Connector Sizes
9738-1216P-X(920)	12	18 thru 36
9738-1216S-X(920)	12	18 thru 36
9745-1418P-X(920)	16	10SL thru 36
9745-1418S-X(920)	16	18 thru 36
9755-1418S-X(920)	16	10SL thru 16S only
9745-1622P-X(920)	16	10SL thru 36
9755-1622S-X(920)	16	10SL, 12S, 14S, 16S only
9745-1622S-X(920)	16	18 thru 36
9745-2026P-X(920)	16	10SL thru 36
9755-2026S-X(920)	16	10SL, 12S, 14S, 16S only
9745-2026S-X(920)	16	18 thru 36
9745-2630P-X(920)	16	10SL thru 36
9755-2630S-X(920)	16	10SL, 12S, 14S, 16S only
9745-2630S-X(920)	16	18 thru 36

Example of part number:

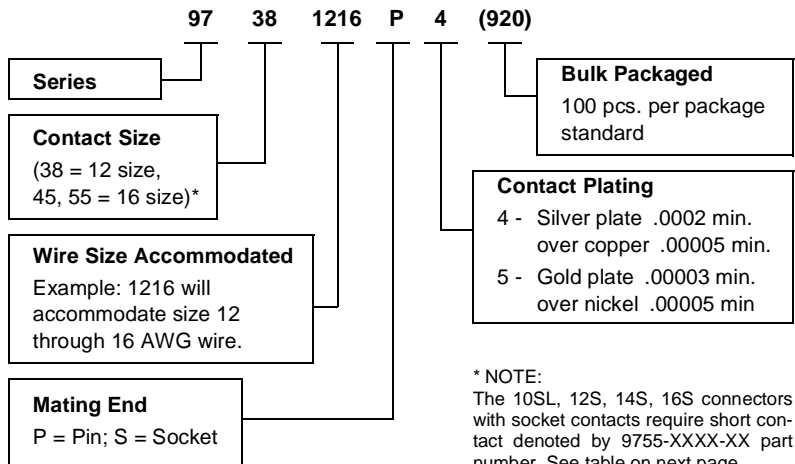

* NOTE:
The 10SL, 12S, 14S, 16S connectors with socket contacts require short contact denoted by 9755-XXXX-XX part number. See table on next page.

97 Series Contact Code Table†

Wire Range**	Contact Code	Pin	Contact Code	Socket	Contact Code	Socket
1622	A	97-45-1622P-X(XXX)	B	97-55-1622S-X(XXX)	C	97-45-1622S-X(XXX)
1418	D	97-45-1418P-X(XXX)	E	97-55-1418S-X(XXX)	F	97-45-1418S-X(XXX)
2026	G	97-45-2026P-X(XXX)	H	97-55-2026S-X(XXX)	I	97-45-2026S-X(XXX)
2630	J	97-45-2630P-X(XXX)	K	97-55-2630S-X(XXX)	L	97-45-2030S-X(XXX)
1216	M	97-38-1216P-X(XXX)			O	97-38-1216S-X(XXX)

Codes in bold letters are most common

† See order information for bulk and reel contact deviation numbers.

** Wire range is size of wires contact will accommodate. For example:

97 series crimp type contact information and tools

Insert / Contact Where Used Tables

Insert Arrangement	Contact Quantity	Contact Size	Use Contacts with Code*	
			Pin	Socket
10SL-3	3	16	A, D, G, J	B, E, H, K
10SL-4	2	16	A, D, G, J	B, E, H, K
12S-3	2	16	A, D, G, J	B, E, H, K
14S-1	3	16	A, D, G, J	B, E, H, K
14S-2	4	16	A, D, G, J	B, E, H, K
14S-5	5	16	A, D, G, J	B, E, H, K
14S-7	3	16	A, D, G, J	B, E, H, K
16S-1	7	16	A, D, G, J	B, E, H, K
16S-8	5	16	A, D, G, J	B, E, H, K
18-1	10	16	A, D, G, J	C, F, I, L
18-4	4	16	A, D, G, J	C, F, I, L
18-11	5	12	M	O
18-12	6	16	A, D, G, J	C, F, I, L
18-19	10	16	A, D, G, J	C, F, I, L

Insert Arrangement	Contact Quantity	Contact Size	Use Contacts with Code*	
			Pin	Socket
18-20	5	16	A, D, G, J	C, F, I, L
20-4	4	12	M	O
20-7	8	16	A, D, G, J	C, F, I, L
20-27	14	16	A, D, G, J	C, F, I, L
20-29	17	16	A, D, G, J	C, F, I, L
22-14	19	16	A, D, G, J	C, F, I, L
24-2	7	12	M	O
28-11	4	12	M	O
	18	16	A, D, G, J	C, F, I, L
28-12	26	16	A, D, G, J	C, F, I, L
28-20	10	12	M	O
	4	16	A, D, G, J	C, F, I, L
28-21	37	16	A, D, G, J	C, F, I, L
32-414	52	16	A, D, G, J	C, F, I, L
36-10	48	16	A, D, G, J	C, F, I, L

* Codes in bold letters are most common. See Code Table on page 28.

Contact Termination Tools

Insertion / Extraction Tools

Part Number:	Contact Size	
	16	12
	M81969/14-03	M81969/14-04

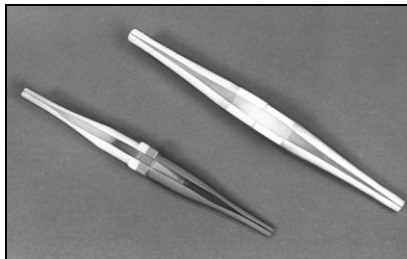

Crimping Tools (Full Cycle Type)

Crimping Tool Part Number	Contact Part Number
357-578	9738-1216X-X thru 9755-1622X-X
357-579	9745-2026X-X 9745-2630X-X 9755-2026X-X 9755-2630X-X



Strip-Crimp Machines

For large production quantities consult Amphenol, Sidney, NY for information on semi-automatic crimping equipment.

Wire Preparation

Strip wire to length shown in chart below. Do not cut or nick wire strands. Twist wire strands back to their original lay.

Contact Size	Contact Part Number	Insulation O.D.	Stripping Length "A"
12	9738-1216X-X	.097 / .160	.200 - .240
16	97XX-1418X-X	.079 / .100	.170 - .190
16	97XX-1622X-X	.079 / .100	.140 - .160
16	97XX-2026X-X	.039 / .090	.140 - .160
16	97XX-2630X-X	.030 / .054	.140 - .160

Note: XX = 45 or 55 (38 = 12 size; 45, 55 = 16 size)

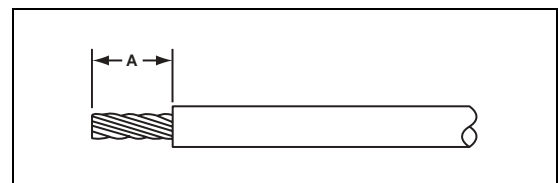

For further information on contact insertion/removal/crimping for 97 Series Connectors, ask for L-1268 assembly instructions.

97 series special purpose connectors

Potting (438 Construction)

Potting constructions actually exceed the Type "E" requirements of military specifications for moisture-proof connectors. These constructions replace the back shell completely with a lightweight threaded retainer ring permanently staked to the shell.

To seal the back of the connector, potting compound is injected into an expendable polyethylene potting form and allowed to cure or set. When the form is removed, the resilient hemispherical shaped insulation extends well into the connector. It forms a chemical bond to the inner and outer walls of the plug, to the back of the insert, around the soldered connections and well out along the leads.

Not only is the back shell eliminated, but also the cable clamp. The solder joints are completely and individually protected by the resilient mass which surrounds them and resists transmittal of vibration to the soldered connections. The completed assembly is not only moisture-proof, but also pressurized and resistant to salt water, aircraft lubricating oil and jet fuels.



Expendable Potting Forms

For companies not using their own potting molds, expendable polyethylene forms can be provided. These expendable forms need no treatment before use. Though designed to be discarded, they can be left on assemblies after potting. Nylon potting forms to be left permanently on the assembly are also available. These forms are supplied with construction (824) and (871).

How to Order

To order connectors in constructions for potting, use the standard MS nomenclature (MS3100A, MS3101A, and MS3106A constructions are available), but substitute "97" for "MS", drop the "A" suffix for type of back shell, and add the application deviation (XXX) as shown on the chart. Example: 97-3106-28-16S (438).

Deviation	Explanation	Shell Styles	
		3100 3101	3106 3107
438	Modified "MS", for potting where back shell is replaced by threaded retainer ring. A type "W" washer is included under 3106 coupling ring. (Boot is not included).	3100 3101	3106 3107
541	Consists of (438) construction with 9755-255-XX expendable poly potting form, and type "W" washer. Connectors are marked "97-310X-XX-XX(541)."	3100 3101	3106 3107
824	Consists of (438) construction plus nylon potting form and type "W" washer; bagged, marked MS25183.	3106	
826	Consists of (517) construction plus nylon potting form and type "W" washer; marked MS25183A.	3106	
871	Consists of (438) construction with 9755-271-XX nylon potting form, and type "W" washer; bagged. Connectors are marked "97-310X-XX-XX(871)."	3100 3101	3106 3107

97 series special purpose connectors

Box Type Plugs (97-5105 construction)

Mounts directly on box or housing. For direct connection of two pieces of equipment without interconnecting wires. Available in all sizes; male or female inserts. To order, complete part number (97-5105) by adding proper insert number.

Example: 97-5105-28-20S. To prevent connector from rotating: Order deviation 205 (single stake, with swivel ring pinned) or 206 (double staking, with both swivel plate and swivel ring pinned).

Example: 97-5105-28-20S (205) or 97-5105-28-20S (206).

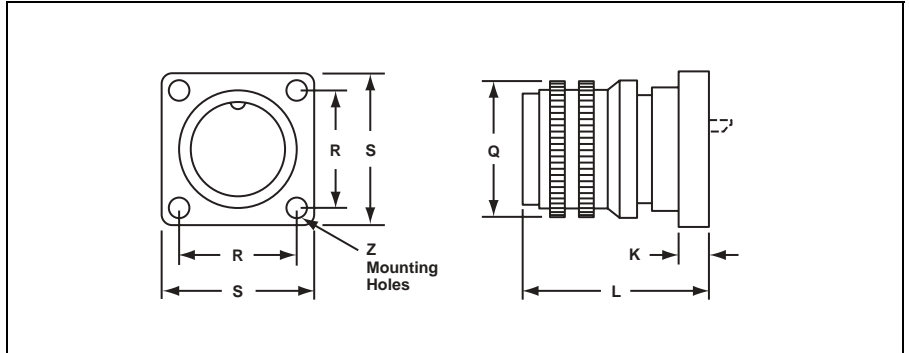

Connector Size	K		L		Q		R		S		Z Mounting Threads
	Inch	mm	Inch	mm	Inch	mm	Inch	mm	Inch	mm	
8S	1/8	3.18	7/8	22.23	3/4	19.05	9/16	14.27	25/32	19.84	4-36
10S	1/8	3.18	7/8	22.23	7/8	22.23	9/16	14.27	25/32	19.84	4-36
12S	5/32	3.96	31/32	24.59	1	25.40	13/16	20.62	1-1/16	26.97	4-36
12	5/32	3.96	1-3/8	34.93	1	25.40	13/16	20.62	1-1/16	26.97	4-36
14S	5/32	3.96	31/32	24.59	1-1/8	28.56	13/16	20.62	1-1/16	26.97	4-36
14	5/32	3.96	1-3/8	34.93	1-1/8	28.56	13/16	20.62	1-1/16	26.97	4-36
16S	5/32	3.96	31/32	24.59	1-1/4	31.75	1	25.40	1-5/16	33.32	6-32
16	5/32	3.96	1-13/32	35.71	1-1/4	31.75	1	25.40	1-5/16	33.32	6-32
18	5/32	3.96	1-13/32	35.71	1-11/32	34.11	1	25.40	1-5/16	33.32	6-32
20	3/16	4.75	1-13/32	35.71	1-15/32	37.29	1-1/4	31.75	1-5/8	41.28	10-24
22	3/16	4.75	1-13/32	35.71	1-19/32	40.46	1-1/4	31.75	1-5/8	41.28	10-24
24	3/16	4.75	1-13/32	35.71	1-23/32	43.64	1-9/16	39.67	2	50.80	10-24
28	3/16	4.75	1-13/32	35.71	1-31/32	49.99	1-9/16	39.67	2	50.80	10-24

Small Flange Receptacle

Small flange, (115) construction, receptacles are available in sizes 12S and 14S with pin or socket inserts and in size 10SL with pin contacts only.

To order, complete part number (97-3102) by adding proper insert and construction numbers; 97-3102A12S-4S (115).

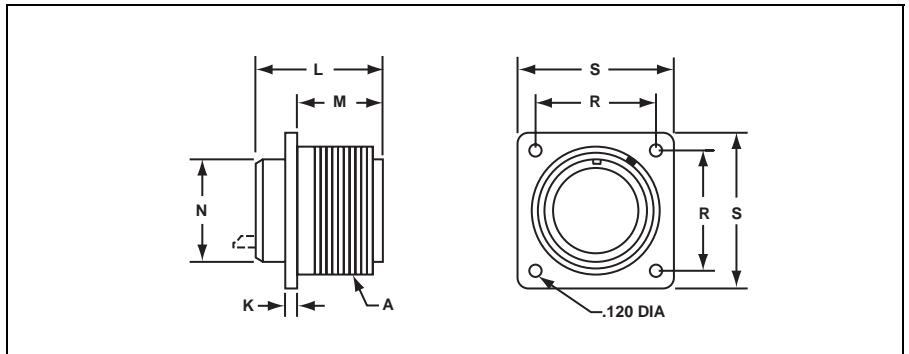

Connector Size	A Coupling Threads	K Ref.		L Max.		M Ref.		N Ref.		R Ref.		S Ref.	
		Inch	mm	Inch	mm	Inch	mm	Inch	mm	Inch	mm	Inch	mm
10SL	5/8-24	5/64	1.98	61/64	24.21	9/16	14.27	5/8	15.88	.625	15.88	13/16	20.62
12S	3/4-20	3/32	2.36	7/8	21.41	9/16	14.27	5/8	15.88	.664	16.87	7/8	22.23
14S	7/8-20	3/32	2.36	7/8	21.41	9/16	14.27	23/32	18.24	.730	18.54	15/16	23.80

97 series special purpose connectors

ECG Connectors

Special purpose connectors used for process control and medical instrumentation applications.



7-8905
97-3102A14S-6S (639)
with insert rotated 30° off normal position between contacts "A" and "F".

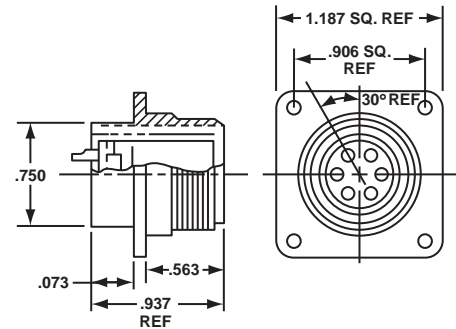

7-8906
97-3106A14S-6P (639)
with insert rotated 30° off normal position between contacts "A" and "F".

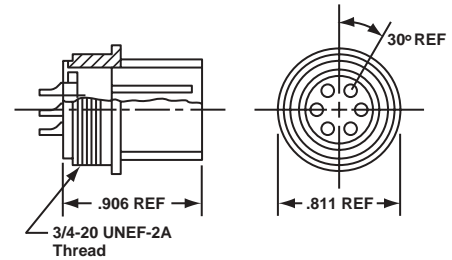

Convenience Outlets

Rated for duty at 15 amps. Provide 1000 VRMS dielectric withstanding voltage and 100 megohms insulation resistance. Will withstand 1000 cycles of use.



7-8649
Convenience plug

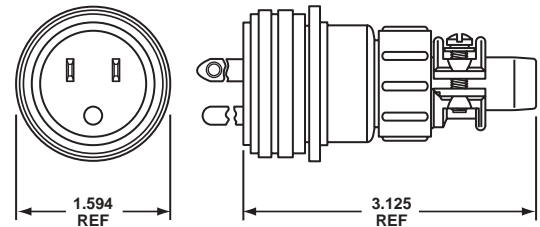

7-8648
Convenience outlet

7-8648-5
Convenience outlet with metal cap and chain

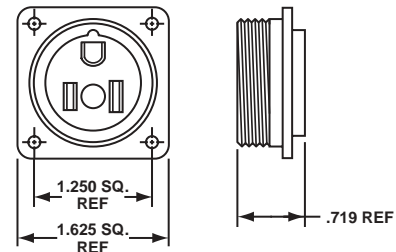

97 series accessories

cable clamps, bushing

Cable Clamp MS3057A Type

For jacketed cable or wires protected by tubing. Both clamping halves float for maximum strain relief. For unjacketed cable or wires, use corresponding MS3420 bushing. To order clamp with bushing, add -1 to the 97-number. Two telescoping bushings are furnished with shells sizes 24 and larger.

This cable clamp is die-cast zinc alloy and limited to the following plating variations:

- Std - olive drab/green chromate
- (621) - black zinc alloy
- (676) - bright nickel
- (624) - green zinc alloy
- (689) - electroless nickel

Bushing MS3420

Rubber bushing specifically designed for MS3057A type cable clamp. Can also be used as a reducing bushing.

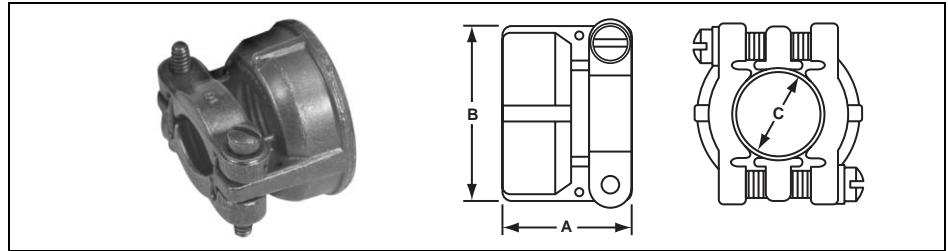

Amphenol Part Number	Shell Size	Max. O.D. Cable		A		B		C		Threads
		Inch	mm	Inch	mm	Inch	mm	Inch	mm	
97-3057-1004	10SL, 12S	5/16	7.92	.795	20.19	.842	21.39	5/16	7.92	5/8-24
97-3057-1007	12SL, 14, 14S	7/16	11.10	.850	21.59	.995	25.27	7/16	11.10	3/4-20
97-3057-1008	16, 16S	9/16	14.27	.920	23.37	1.120	28.45	9/16	14.27	7/8-20
97-3057-1010	18	5/8	15.88	.920	23.37	1.216	30.89	5/8	15.88	1 -20
97-3057-1012	20, 22	3/4	19.05	.927	23.55	1.403	35.64	3/4	19.05	1-3/16-18
97-3057-1016	24, 28	15/16	23.80	1.015	25.78	1.683	42.75	15/16	23.80	1-7/16-18
97-3057-1020	32	1-1/4	31.75	1.095	27.81	2.050	52.07	1-1/4	31.75	1-3/4-18
97-3057-1024	36	1-3/8	34.93	1.156	29.36	2.245	57.02	1-3/8	34.93	2 -18

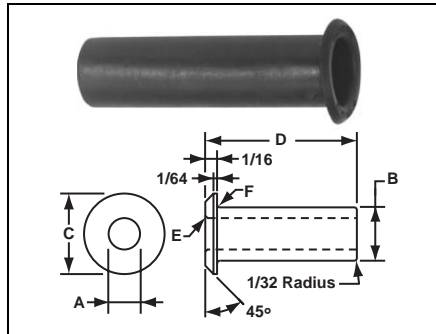

Bushing Part Number		A		B		C		D		E		F	
MS	Amphenol	Inch	mm	Inch	mm	Inch	mm	Inch	mm	Inch	mm	Inch	mm
3420-3	9779-513-3	.130	3.30	.210	5.33	.374	9.50	2.875	73.03	1/32	.79	1/32	.79
3420-4	9779-513-4	.220	5.59	.302	7.67	.500	12.70	2.750	69.85	1/32	.79	1/32	.79
3420-6	9779-513-6	.312	7.92	.427	10.85	.614	15.60	2.625	66.68	1/32	.79	1/16	1.57
3420-8	9779-513-8	.437	11.10	.552	14.02	.739	18.77	2.500	63.50	1/16	1.57	1/16	1.57
3420-10	9779-513-10	.562	14.27	.615	15.62	.889	22.58	2.375	60.33	1/16	1.57	1/16	1.57
3420-12	9779-513-12	.625	15.88	.740	18.80	1.084	27.53	2.250	57.15	1/16	1.57	1/16	1.57
3420-16	9779-513-16	.750	19.05	.927	23.55	1.309	26.39	2.125	53.98	1/16	1.57	1/16	1.57
3420-20	9779-513-20	.937	23.80	1.240	31.50	1.591	40.41	2.000	50.80	1/16	1.57	1/16	1.57
3420-24	9779-513-24	1.250	31.75	1.365	34.67	1.842	46.79	1.875	47.63	1/16	1.57	1/16	1.57

Cable Clamp AN3057 Type

For jacketed cable or wires protected by tubing. Cable or wires should be centered in jaws of clamp for maximum grip. A vinyl or rubber bushing or sleeve may be used for centering. One resilient washer and two fiber washers are included with each clamp. This cable clamp is die-cast zinc alloy and limited to the following plating variations:

- Std - olive drab/green chromate
- (621) - black zinc alloy
- (676) - bright nickel
- (624) - green zinc alloy
- (689) - electroless nickel

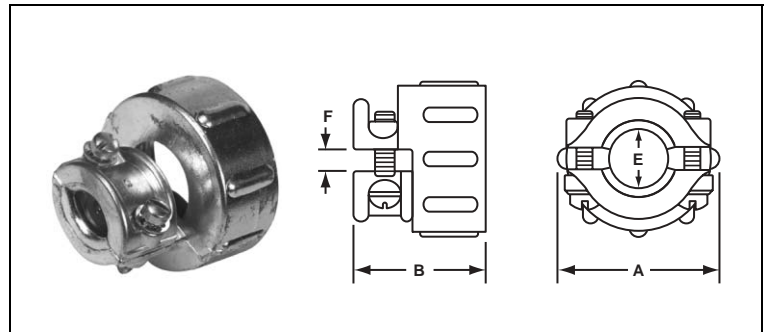

AN Number	Fits Shell Size	Fits AN Fitting Size	Max O.D. Cable		A		B		E		F		Threads	Weight Lbs. per 100
			Inch	mm	Inch	mm	Inch	mm	Inch	mm				
97-3057-3	8S, 10S	3	1/4	6.35	11/16	17.45	1	25.40	1/4	6.35	1/8	3.18	1/2-28	1.89
97-3057-4	10SL, 12S	4	5/16	7.92	25/32	19.84	1	25.40	5/16	7.92	3/16	4.75	5/8-24	2.12
97-3057-6	12SL, 14, 14S	6	7/16	11.10	15/16	23.80	1-5/64	27.38	7/16	11.10	3/16	4.75	3/4-20	2.94
97-3057-8	16, 16S	8	9/16	14.27	1-1/16	26.97	1-1/8	28.58	9/16	14.27	9/32	7.14	7/8-20	3.44
97-3057-10	18	10	5/8	15.88	1-3/16	30.15	1-1/8	28.58	5/8	15.88	5/16	7.92	1 -20	4.72
97-3057-12	20, 22	12	3/4	19.05	1-3/8	34.93	1-3/16	30.15	3/4	19.05	5/16	7.92	1-3/16-18	6.10
97-3057-16	24, 28	16	15/16	23.80	1-5/8	41.28	1-5/16	33.32	15/16	23.80	3/8	9.53	1-7/16-18	8.71
97-3057-20	32	20	1-1/4	31.75	1-15/16	49.20	1-1/2	38.10	1-1/4	31.75	1/2	12.70	1-3/4-18	14.85
97-3057-24	36	24	1-3/8	34.93	2-3/16	55.55	1-9/16	39.67	1-3/8	34.93	19/32	15.06	2 -18	18.15
97-3057-28	40	28	1-5/8	41.28	2-1/2	63.50	1-9/16	39.67	1-5/8	41.28	21/32	16.66	2-1/4-16	21.50

97 series accessories

cable clamps, cont.

Step-Down Clamp 97-3057

Similar to AN3057 clamp, except step-down feature accommodates smaller cable.

This cable clamp is die-cast zinc alloy and limited to the following plating variations:

- Std - olive drab/green chromate
- (621) - black zinc alloy
- (676) - bright nickel

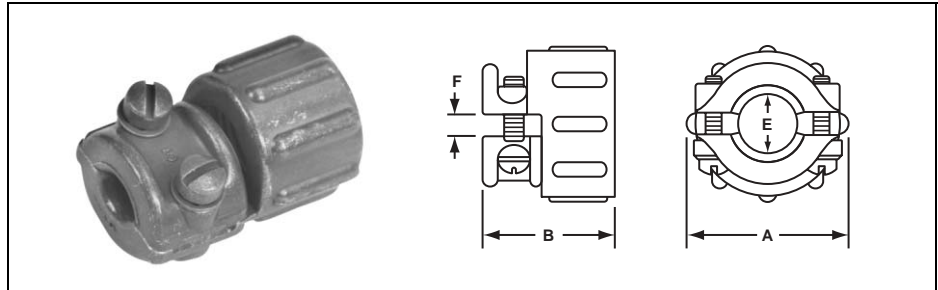

Amphenol Part Number	Fits Shell Size	Fits AN Fitting Size	Max O.D. Cable		A		B		E		F		Threads	Weight Lbs. per 100
			Inch	mm	Inch	mm	Inch	mm	Inch	mm	Inch	mm		
97-3057-10-6	18	10	1/2	12.70	1-13/16	30.15	1-1/8	28.58	7/16	11.10	3/16	4.75	1 -20	3.94
97-3057-12-6	20, 22	12	1/2	12.70	1-3/8	34.93	1-3/16	30.15	7/16	11.10	3/16	4.75	1-3/16-18	4.40

9767 Water Resistant Cable Clamp

The 9767 assembly includes AN3057 clamp, a rubber bushing, a washer and the AN3055 adapter. To assure best results, the plug must be ordered with deviation (417), which supplies a W washer on the shoulder of the plug shell.

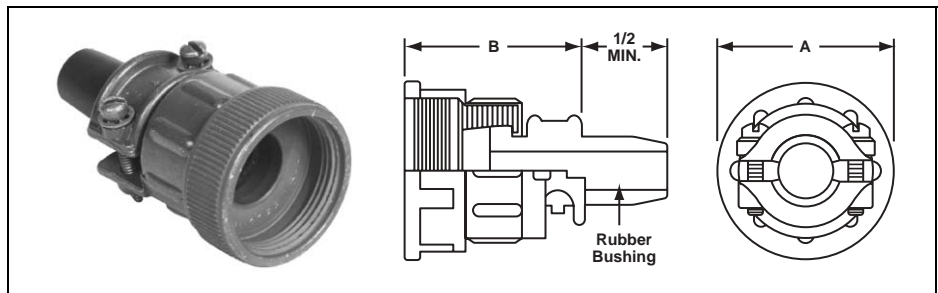

Max. O.D. Cable		Amphenol Part Number	Connector Size	A		B		Threads	Weight Lbs. per 100
Inch	mm			Inch	mm	Inch	mm		
7/32	5.55	9767-12-4	10SL, 12S, 12	25/32	19.84	1-17/32	38.89	5/8-24	3.82
		9767-14-4	12SL, 14S, 14	29/32	23.01	1-17/32	38.89	3/4-20	3.87
		9767-16-4	16S, 16	1-1/16	26.97	1-17/32	38.89	7/8-20	4.00
11/32	8.73	9767-14-6	12SL, 14S, 14	29/32	23.01	1-19/32	40.46	3/4-20	5.54
		9767-16-6	16S, 16	1-1/16	26.97	1-19/32	40.46	7/8-20	5.84
		9767-18-6	18	1-3/16	30.15	1-19/32	40.46	1 -20	5.94
7/16	11.12	9767-16-8	16S, 16	1-1/16	26.97	1-19/32	40.46	7/8-20	6.92
		9767-18-8	18	1-3/16	30.15	1-19/32	40.46	1 -20	7.10
		9767-22-8	20, 22	1-3/8	34.93	1-19/32	40.46	1-3/16-18	7.27
9/16	14.29	9767-18-10	18	1-3/16	30.15	1-19/32	40.46	1 -20	8.79
		9767-22-10	20, 22	1-3/8	34.93	1-19/32	40.46	1-3/16-18	8.97
		9767-28-10	24, 28	1-5/8	41.28	1-17/32	38.89	1-7/16-18	9.12
11/16	17.46	9767-22-12	20, 22	1-3/8	34.93	1-21/32	42.06	1-3/16-18	12.65
		9767-28-12	24, 28	1-5/8	41.28	1-21/32	42.06	1-7/16-18	12.86
27/32	21.43	9767-28-16	24, 28	1-5/8	41.28	1-25/32	45.24	1-7/16-18	14.95
		9767-36-16	36	2-3/16	55.56	1-31/32	50.00	2 -18	16.36
1-1/32	26.19	9767-32-20	32	1-15/16	49.20	1-31/32	50.00	1-3/4-18	22.27

Cable Clamp for AN fittings

In selecting a cable clamp for a connection with AN fittings, the 9767 clamp with the adapter plug may be used.

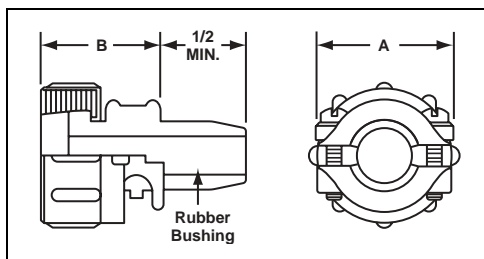

Max. Cable O.D.		Amphenol Part Number	Fitting Size	A		B		Threads	Weight Lbs. per 100
Inch	mm			Inch	mm	Inch	mm		
7/32	5.54	9767-4	4	25/32	19.84	1	25.40	5/8-24	2.45
11/32	8.71	9767-6	6	29/32	23.01	1-5/64	27.38	3/4-20	3.94
7/16	11.10	9767-8	8	1-1/16	26.97	1-1/8	28.58	7/8-20	4.57
9/16	14.27	9767-10	10	1-3/16	30.15	1-1/8	28.58	1 -20	5.97
11/16	17.45	9767-12	12	1-3/8	34.93	1-3/16	30.15	1-3/16-18	7.85
27/32	21.41	9767-16	16	1-5/8	41.28	1-5/16	33.32	1-7/16-18	9.53

97 series accessories

metal protection caps

9760 Caps and Chain Assemblies

Fit MS and 97 type receptacles and plugs; provide protection against live circuits and keep out dirt and dust when connector is not in use.

Two styles are available: one with a stainless steel link chain, and one with a beaded chain. Both use the same caps and both have a cadmium olive drab finish.

Caps for receptacles have internal threads and are used on MS3102, MS3101, and MS3100 receptacles. A soft rubber disc seats on the connector shell, forming a water-tight joint.

Caps for plugs have external threads for use on all plugs where a coupling nut is provided (MS3106 and MS3108).

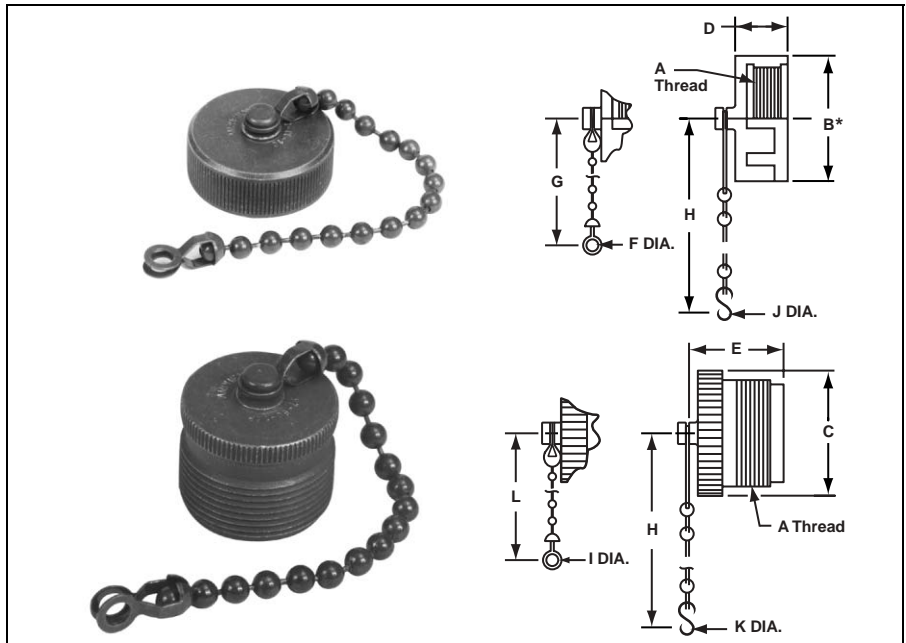

For Receptacles†		For Plugs†		For Connector Size	A Threads	B*		C		D*		E	
Link Chain	Bead Chain	Link Chain	Bead Chain			Inch	mm	Inch	mm	Inch	mm	Inch	mm
9760-908	9760-8	9760-808	9760-8P	8S	1/2-28	5/8	15.88	1/2	12.70	7/16	11.10	21/32	16.66
9760-910	9760-10	9760-810	9760-10P	10S, 10SL	5/8-24	13/16	20.62	5/8	15.88	7/16	11.10	21/32	16.66
9760-912	9760-12	9760-812	9760-12P	12, 12S, 12SL	3/4-20	15/16	23.80	3/4	19.05	7/16	11.10	27/32	21.41
9760-914	9760-14	9760-814	9760-14P	14, 14S	7/8-20	1-1/16	26.97	7/8	22.23	7/16	11.10	27/32	21.41
9760-916	9760-16	9760-816	9760-16P	16, 16S	1 -20	1-1/8	28.58	1	25.40	7/16	11.10	27/32	21.41
9760-918	9760-18	9760-818	9760-18P	18	1-1/8-18	1-5/16	33.32	1-1/8	28.58	7/16	11.10	27/32	21.41
9760-920	9760-20	9760-820	9760-20P	20	1-1/4-18	1-7/16	36.50	1-1/4	31.75	7/16	11.10	27/32	21.41
9760-922	9760-22	9760-822	9760-22P	22	1-3/8-18	1-9/16	39.67	1-3/8	34.93	7/16	11.10	27/32	21.41
9760-924	9760-24	9760-824	9760-24P	24	1-1/2-18	1-11/16	42.85	1-1/2	38.10	7/16	11.10	27/32	21.41
9760-928	9760-28	9760-828	9760-28P	28	1-3/4-18	1-59/64	48.79	1-3/4	44.45	1/2	12.70	27/32	21.41
9760-932	9760-32	9760-832	9760-32P	32	2 -18	2-3/16	55.55	2	50.80	1/2	12.70	27/32	21.41
9760-936	9760-36	9760-836	9760-36P	36	2-1/4-16	2-7/16	61.90	2-1/4	57.15	1/2	12.70	27/32	21.41

For Connector Size	F		G		H ± 1 Link		I		J		K		L	
	Inch	mm	Inch	mm	Inch	mm	Inch	mm	Inch	mm	Inch	mm	Inch	mm
8S	.125	3.18	2-9/16	65.07	4.0	101.60	.125	3.18	.140	3.56	.156	3.96	2-9/16	65.07
10S, 10SL	.125	3.18	2-9/16	65.07	4.0	101.60	.125	3.18	.140	3.56	.156	3.96	2-13/16	71.44
12, 12S, 12SL	.125	3.18	2-9/16	65.07	4.5	114.30	.125	3.18	.140	3.56	.156	3.96	3-13/16	96.84
14, 14S	.125	3.18	2-9/16	65.07	4.5	114.30	.125	3.18	.140	3.56	.156	3.96	3-13/16	96.84
16, 16S	.167	4.24	4-5/8	117.48	4.5	114.30	.167	4.24	.140	3.56	.156	3.96	4-5/8	117.48
18	.167	4.24	4-5/8	117.48	4.5	114.30	.167	4.24	.140	3.56	.156	3.96	4-5/8	117.48
20	.167	4.24	4-5/8	117.48	5.0	127.00	.167	4.24	.140	3.56	.187	4.75	4-5/8	117.48
22	.167	4.24	4-5/8	117.48	5.0	127.00	.167	4.24	.140	3.56	.187	4.75	4-5/8	117.48
24	.167	4.24	4-5/8	117.48	5.5	139.70	.167	4.24	.171	4.34	.187	4.75	4-5/8	117.48
28	.167	4.24	4-5/8	117.48	7.75	196.85	.167	4.24	.171	4.34	.187	4.75	4-5/8	117.48
32	.190	4.83	5-3/4	146.05	7.75	196.85	.260	6.60	.187	4.75	.218	5.54	5-3/4	146.05
36	.190	4.83	5-3/4	146.05	7.75	196.85	.260	6.60	.187	4.75	.218	5.54	5-3/4	146.05

* B dimension 1/16 inch less, and D dimension 1/64 inch less for screw machine parts, sizes 8 thru 22.

† Caps less chains are available. To order, add G to the part number; for example, 9760-908G.

97 series accessories

polyethylene protection caps

97121 Polyethylene Protective Dust Caps

Expendable polyethylene dust caps provide added protection for connectors during storage and handling, in assembling with other equipment, and after complete assembly into a finished apparatus. Protective caps cover threaded sections of plugs and receptacles, assure against damage to threads from any cause; permit low-cost, attractive coverings which protect contacts and the insulation from dust, dirt and handling damage.

To order connectors complete with caps:

When ordering new connectors, it is best to arrange to have the connectors arrive at your plant with caps assembled. This will assure you of protection against thread damage, dust and foreign matter in transit, in your stock and on your assembly line until the connectors are finally mated. To order connectors complete with protective caps assembled to both ends, specify (258) after the connector number; for example: MS3106A20-20P(258), or MS3102A20-20S(258).

To order caps separately:

Type 97121-4XXY - For engagement with internal threads of coupling rings.
Example of complete part number: 97121-408Y

Type 97121-4XXR - For engagement with external threads for coupling and fitting threads.
Example of complete part number: 97121-408R

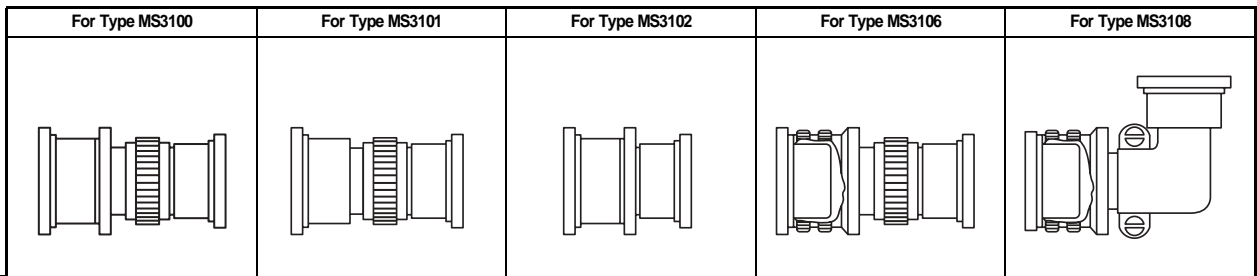

Connector Size	For Type MS3100		For Type MS3101		For Type MS3102		For Type MS3106		For Type MS3108	
	Mating End	Termination End	Mating End	Termination End	Mating End	Termination End	Mating End	Termination End	Mating End	Termination End
8S	-408R	-408R	-408R	-408R	-408R		-408Y	-408R	-408Y	-408R
10S	-410R	-408R	-410R	-408R	-410R	-408R	-410Y	-408R	-410Y	-408R
10SL	-410R	-410R	-410R	-410R	-410R	-410R	-410Y	-410R	-410Y	-410R
12S-12	-412R	-410R	-412R	-410R	-412R		-412Y	-410R	-412Y	-410R
14S-14	-414R	-412R	-414R	-412R	-414R	-412R	-414Y	-412R	-414Y	-412R
16S-16	-416R	-414R	-416R	-414R	-416R	-414R	-416Y	-414R	-416Y	-414R
18	-418R	-416R	-418R	-416R	-418R	-416R	-418Y	-416R	-418Y	-416R
20	-420R	-420Y	-420R	-420Y	-420R	-418R	-420Y	-420Y	-420Y	-420Y
22	-422R	-420Y	-422R	-420Y	-422R	-420R	-422Y	-420Y	-422Y	-420Y
24	-424R	-424Y	-424R	-424Y	-424R	-422R	-424Y	-424Y	-424Y	-424Y
28	-428R	-424Y	-428R	-424Y	-428R		-428Y	-424Y	-428Y	-424Y
32	-432R	-428R	-432R	-428R	-432R		-432Y	-428R	-432Y	-428R
36	-436R	-432R	-436R	-432R	-436R		-436Y	-432R	-436Y	-432R
40	-440R	-436R	-440R	-436R	-440R		-440Y	-436R	-440Y	-436R

97 series accessories

connector adapters

97-3055 Adapter

Used as reducing or extending bushing.
 Note: 97-3055 supersedes part number AN-3055.

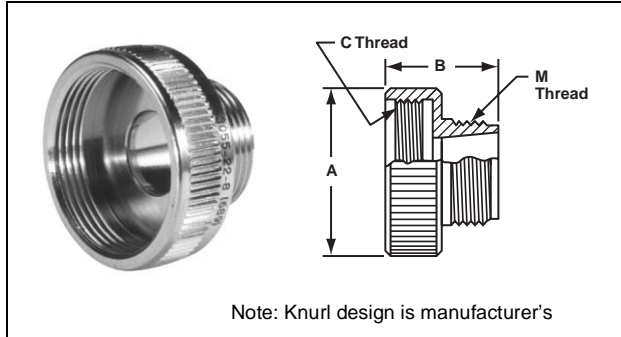

Conduit Size		AN Number	Used on Connector Size	A		B		C Threads	M Threads	Weight Lbs. per 100
Inch	mm			Inch	mm	Inch	mm			
1/4	6.35	97-3055-12-4	12S, 12	25/32	18.24	7/8	22.23	5/8-24	5/8-24	1.37
		97-3055-14-4	14S, 14	29/32	23.01	7/8	22.23	3/4-24	5/8-24	1.42
3/8	9.53	97-3055-14-6	14S, 14	29/32	23.01	7/8	22.23	3/4-20	3/4-20	1.60
		97-3055-16-6	16S, 16	1-1/16	26.97	7/8	22.23	7/8-20	3/4-20	1.90
		97-3055-18-6	18	1-3/16	30.15	7/8	22.23	1 -20	3/4-20	2.00
1/2	12.70	97-3055-16-8	16S, 16	1-1/16	26.97	7/8	22.23	7/8-20	7/8-20	2.35
		97-3055-18-8	18	1-3/16	30.15	7/8	22.23	1 -20	7/8-20	2.53
		97-3055-22-8	20, 22	1-3/8	34.93	7/8	22.23	1-3/16-18	7/8-20	2.70
5/8	17.88	97-3055-18-10	18	1-3/16	30.15	7/8	22.23	1 -20	1 -20	2.82
		97-3055-22-10	20, 22	1-3/8	34.93	7/8	22.23	1-3/16-18	1 -20	3.00
		97-3055-28-10	24, 28	1-5/8	41.28	7/8	22.23	1-7/16-18	1 -20	3.15
3/4	19.05	97-3055-22-12	20, 22	1-3/8	34.93	7/8	22.23	1-3/16-18	1-3/16-18	4.80
		97-3055-28-12	24, 28	1-5/8	41.28	7/8	22.23	1-7/16-18	1-3/16-18	5.01
1	25.40	97-3055-28-16	24, 28	1-5/8	41.28	7/8	22.23	1-7/16-18	1-7/16-18	5.42
		97-3055-32-16	32	1-15/16	49.20	15/16	23.80	1-3/4-18	1-7/16-18	5.60
		97-3055-36-16	36	2-3/16	55.55	1-1/16	26.97	2 -18	1-7/16-18	5.73

97-3055-120 Adapter, Type II 97-3055-121 Adapter, Type I

Used to terminate pipe threads.

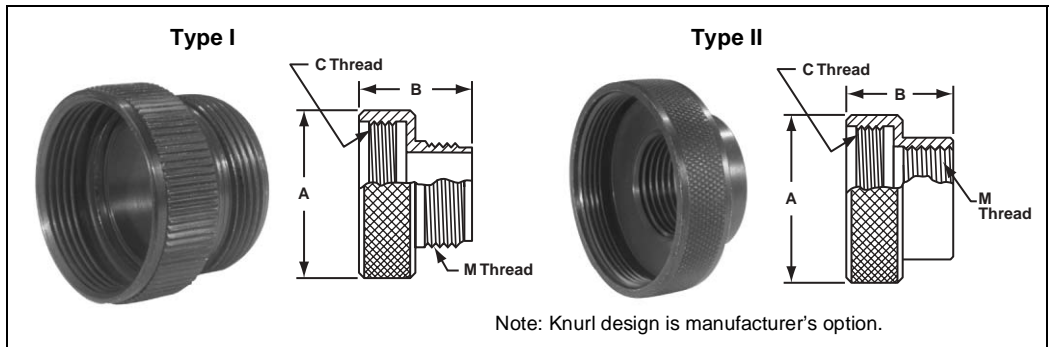

M Thread Size	Type	Part Number	Shell Sizes	A Ref.		B Max.		C Thread
				Inch	mm	Inch	mm	
1/2 NPT	II	97-3055-120-18002	18,	1-3/16	30.15	1-1/8	22.23	1 -20
		97-3055-120-22002	20, 22	1-3/8	34.93	1-1/8	22.23	1-3/16-18
		97-3055-120-28002	24, 28	1-5/8	41.28	1-1/8	22.23	1-7/16-18
	I	97-3055-121-18002	18,	1-3/16	30.15	1-1/8	22.23	1 -20
		97-3055-121-22002	20, 22	1-3/8	34.93	1-1/8	22.23	1-3/16-18
		97-3055-121-28002	24, 28	1-5/8	41.28	1-1/8	22.23	1-7/16-18
3/4 NPT	II	97-3055-120-28003	24-28	1-15/16	49.20	1-3/16	28.30	1-7/16-18
	I	97-3055-121-28003	24-28	1-15/16	49.20	1-3/16	28.30	1-7/16-18
3/4 NPT	II	97-3055-120-32003	32	1-15/16	49.20	1-3/16	23.80	1-3/4-18
	I	97-3055-121-32003	32	1-15/16	49.20	1-3/16	23.80	1-3/4-18

97 series accessories

conduit box connectors, conduit coupling nuts

97-3064 Conduit Box Connector

Used with AN3066 locknut to form termination at conduit boxes or panel. May be used with AN3057 clamp to relieve strain on wiring cable terminals.

Note: 97-3064 supersedes AN3064.

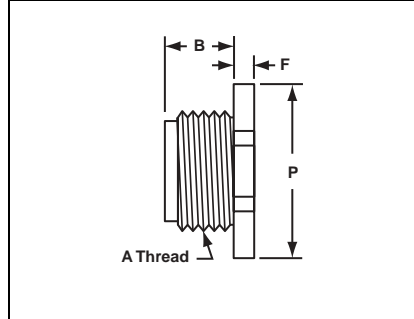

Max. Conduit Size		Part Number	Use Conduit Coupling Lock Nut Size	Use Conduit Coupling Nut Size	A Thread	B		F		P		Weight Lbs. per 100
Inch	mm					Inch	mm	Inch	mm	Inch	mm	
1/4	6.35	97-3064-4	97-3066-4	97-3054-4	5/8-24	5/8	19.05	1/8	3.18	13/16	20.62	1.75
3/8	9.53	97-3064-6	97-3066-6	97-3054-6	3/4-20	5/8	19.05	1/8	3.18	15/16	23.80	2.18
1/2	12.70	97-3064-8	97-3066-8	97-3054-8	7/8-20	11/16	22.23	3/16	4.75	1-1/16	26.97	3.15
5/8	17.88	97-3064-10	97-3066-10	97-3054-10	1 -20	11/16	22.23	3/16	4.75	1-1/4	31.75	3.94
3/4	19.05	97-3064-12	97-3054-12	97-3054-12	1-3/16-18	11/16	22.23	3/16	4.75	1-3/8	34.93	4.98

97-3054 Conduit Coupling Nut

Note: 97-3054 supersedes AN3054.

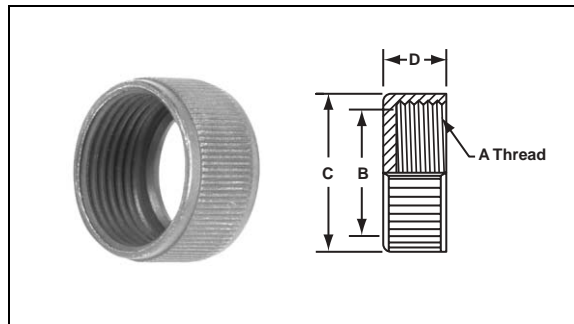

Max. Conduit Size		Part Number	MS Connector Size	AN Conduit Fitting Size	A Thread	B		C		D		Weight Lbs. per 100
Inch	mm					Inch	mm	Inch	mm	Inch	mm	
3/8	9.53	97-3054-6	14, 14S	6	3/4-20	.583	14.81	27/32	21.41	7/16	11.10	.70
5/8	17.88	97-3054-10	18	10	1 -20	.833	21.16	1-1/8	28.58	7/16	11.10	1.31
3/4	19.05	97-3054-12	20, 22	12	1-3/16-18	.933	23.70	1-5/16	33.32	7/16	11.10	1.60
1	25.40	97-3054-16	24, 28	16	1-7/16-18	1.278	32.46	1-9/16	39.67	7/16	11.10	1.90

97-3066 Conduit Coupling Lock Nut

Note: 97-3066 supersedes AN3066.

Conduit Size		Part Number	A Thread	F		P		Q		Weight Lbs. per 100
Inch	mm			Inch	mm	Inch	mm	Inch	mm	
1/4	6.35	97-3066-4	5/8-24	1/8	3.18	13/16	20.62	15/16	23.80	.36
3/8	9.53	97-3066-6	3/4-20	1/8	3.18	15/16	23.80	1-3/32	27.76	.41
1/2	12.70	97-3066-8	7/8-20	3/16	4.75	1-1/16	26.97	1-15/64	31.34	.72
5/8	15.88	97-3066-10	1 -20	3/16	4.75	1-1/4	31.75	1-7/16	34.21	.86
3/4	19.05	97-3066-12	1-3/16-18	3/16	4.75	1-3/8	34.93	1-19/32	40.46	1.01

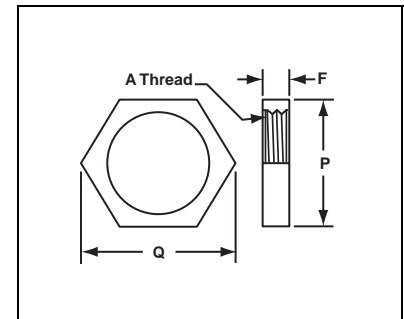

97 series accessories

sealing gaskets

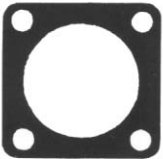
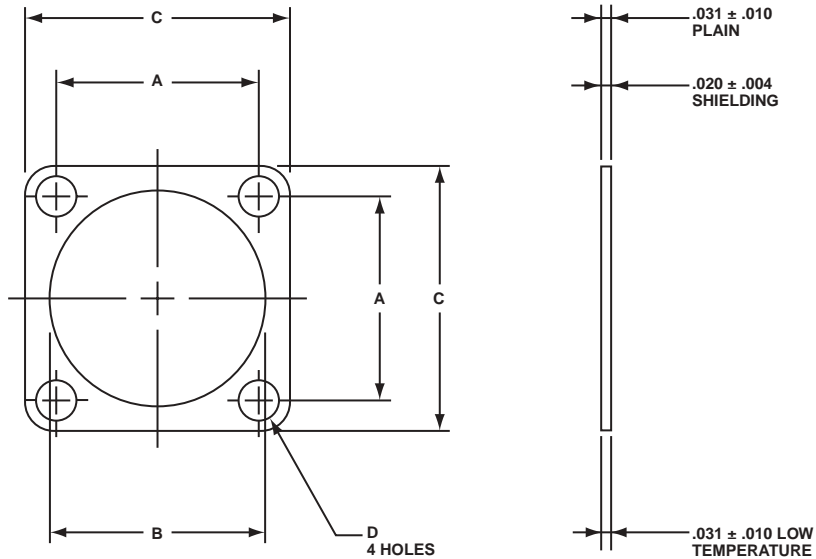

The Amphenol® plain flat gasket of synthetic rubber material is provided to take complete advantage of waterproof and pressure sealing features. It is for use with the flange mounted receptacle.

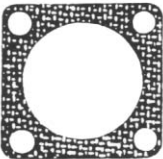

This flat gasket is provided to give the maximum in connector performance. Its special feature is in providing the maximum radio shielding under difficult conditions of high receiver sensitivity and low signal strength while retaining the sealing characteristics of the plain gasket. This gasket is for use with the flange mounting receptacle.

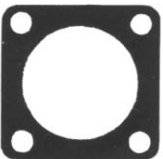

This gasket is provided for applications where the major requirement is resistance to the injurious effects of extremely low temperature. Even at temperatures as low as -67°F this gasket retains its resiliency and will seal a pressure differential of 30 psi.

Shell Size	Installation Dimensions				Order Data		
	A $\pm .010$	B $+ .016$ $- .000$	C $+ .016$ $- .000$	D $\pm .010$	Plain	Shielding	Low Temperature
8S	.594	.500	.875	.172	10-40450-8	10-40450-8S	10-36675-8
10S	.719	.625	1.000	.172	10-40450-10	10-40450-10S	10-36675-10
10SL	.719	.625	1.000	.172	10-40450-10	10-40450-10S	10-36675-10
12S	.813	.750	1.094	.172	10-40450-12	10-40450-12S	10-36675-12
12	.813	.750	1.094	.172	10-40450-12	10-40450-12S	10-36675-12
14S	.906	.875	1.188	.172	10-40450-14	10-40450-14S	10-36675-14
14	.906	.875	1.188	.172	10-40450-14	10-40450-14S	10-36675-14
16S	.969	1.000	1.281	.172	10-40450-16	10-40450-16S	10-36675-16
16	.969	1.000	1.281	.172	10-40450-16	10-40450-16S	10-36675-16
18	1.063	1.125	1.375	.203	10-40450-18	10-40450-18S	10-36675-18
20	1.156	1.250	1.500	.203	10-40450-20	10-40450-20S	10-36675-20
22	1.250	1.375	1.625	.203	10-40450-22	10-40450-22S	10-36675-22
24	1.375	1.500	1.750	.203	10-40450-24	10-40450-24S	10-36675-24
28	1.563	1.750	2.000	.203	10-40450-28	10-40450-28S	10-36675-28
32	1.750	2.000	2.250	.219	10-40450-32	10-40450-32S	10-36675-32
36	1.938	2.188	2.500	.219	10-40450-36	10-40450-36S	10-36675-36
40	2.188	2.438	2.750	.219	10-40450-40	10-40450-40S	10-36675-40

All dimensions for reference only.

97 series accessories

dummy receptacles

97-181 Dummy Receptacle Shells

Same as MS receptacle less insert and contacts.
Used to anchor MS plugs when not in use.

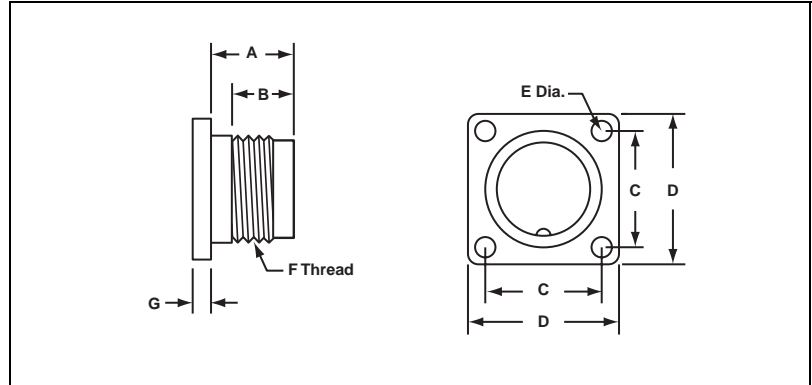

For Connector Size	Amphenol Part Number	A		B		C		D		E Dia.		F Thread	G Mounting Flange Thickness				Weight Lbs. per 100
		Inch	mm	Inch	mm	Inch	mm	Inch	mm	Inch	mm		Max.		Min.		
													Inch	mm	Inch	mm	
10S	97-181-10S	.562	14.27	.375	9.53	.719	18.26	1.000	25.40	.120	3.05	5/8-24	.156	3.96	.078	1.98	1.10
12S	97-181-12S	.562	14.27	.375	9.53	.812	20.62	1.094	27.79	.120	3.05	3/4-20	.156	3.96	.078	1.98	1.73
14S	97-181-14S	.562	14.27	.375	9.53	.906	23.01	1.188	30.18	.120	3.05	7/8-20	.156	3.96	.078	1.98	2.00
16S	97-181-16S	.562	19.05	.375	9.53	.969	24.61	1.281	32.54	.120	3.05	1 -20	.156	3.96	.078	1.98	2.35
16	97-181-16	.750	19.05	.625	15.88	.969	24.61	1.281	32.54	.120	3.05	1 -20	.156	3.96	.078	1.98	3.10
18	97-181-18	.750	19.05	.625	15.88	1.062	26.97	1.375	34.93	.120	3.05	1-1/8-16	.203	5.16	.094	2.39	3.18
20	97-181-20	.750	19.05	.625	15.88	1.156	29.36	1.500	38.10	.120	3.05	1-1/4-18	.203	5.16	.094	2.39	3.80
22	97-181-22	.750	19.05	.625	15.88	1.250	31.75	1.625	41.28	.120	3.05	1-3/8-18	.203	5.16	.094	2.39	4.50
24	97-181-24	.812	20.62	.625	15.88	1.375	34.92	1.750	44.45	.147	3.73	1-1/2-18	.203	5.16	.094	2.39	5.00
28	97-181-28	.812	20.62	.625	15.88	1.562	39.67	2.000	50.80	.147	3.73	1-3/4-18	.203	5.16	.094	2.39	6.58
32	97-181-32	.875	22.23	.625	15.88	1.750	44.45	2.250	57.15	.173	4.39	2 -18	.359	9.12	.125	3.18	9.75

Additional Products

other MIL-5015 type connectors from Amphenol

MS/Standard MIL-5015 Type Connectors

Amphenol has long been the accepted leader in providing MS/Standard MIL-5015 type connectors. When a Mil-Spec 5015 connector is required, these connectors provide well-proven electrical capability. They are tested to strict adherence to military specifications, and they are offered in a very broad range of product styles and options. Features include:

- medium to heavy weight cylindrical with resilient inserts
- environmental resistant
- threaded couplings, single key/keyway shell polarization
- operating voltage to 3000 VAC (RMS) at sea level
- 5 shell styles, 19 shell sizes, 280 contact arrangements
- solder or crimp contacts (non-rear-release type), sizes 16–0 accepting 22–0 AWG
- coaxial or thermocouple contact options
- alternate insert positioning
- hermetic configurations available
- zinc alloy plating (cadmium-free) available

Within the MS/Standard family there are five mil-spec classes to meet different requirements:

A – Solid Shell – for general, non-environmental applications.

C – Pressurized – for use on pressurized bulkheads or pressure barriers; limits air leakage regardless of type and class of plug mated with them.

E/F – Environmental Resisting with Strain Relief – designed for applications where the connector will be exposed to moisture, vibration, and rapid changes in pressure and temperature.

R – Lightweight Environmental Resisting – shorter in length, lighter in weight than the E & F classes, the MS-R offers a high degree of reliability under adverse conditions: recommended for new design applications.

See online (www.amphenol-industrial.com) or ask for Amphenol catalog 12-020 which gives detailed information on this family of connectors.



Amphenol® MS/Standard MIL-5015 Connectors

Amphenol® Pre-Earth FMLB Connectors

Amphenol® Pre-Earth/First Mate Last Break Connectors are designed for applications where a protective circuit from the ground contact to the shell is a safety requirement. These connectors provide a path for any stray voltage to be shunted to a safe ground avoiding harm to the operator and the voltage sensitive equipment.

Features of Pre-Earth FMLB (DL Series) Connectors:

- MIL-5015 dimensions and performance where applicable.
- Conformity with European safety standards (DIN VDE 0627 and certified through TÜV Product Service GMBH) in the approved insert arrangement. Offered in shell styles: 3102A box mount, 3106A straight plug, 3108A 90 degree plug.
- Intermateable with MS 5015 and 97 Series styles.
- Class IP67 protection in the mated condition.
- Main joint gasket between plug and receptacle shells provides superior moisture sealing.
- Pre-earth (ground contact) design.
- First mate, last break capability.
- Standard plating is black zinc alloy. Green zinc plating is an option.

See online (www.amphenol-industrial.com) or ask for Amphenol Product Data sheet #187 for detailed information on Pre-Earth FMLB Connectors.



Amphenol® Pre-Earth FMLB Connectors

Pre-Earth (ground) contact mates first and provides safety from voltage outputs - protects operators and sensitive circuits.

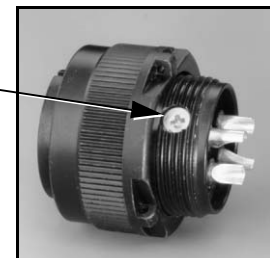

Additional Products

other MIL-5015 type connectors from Amphenol, cont.

ACA-B Reverse Bayonet Connectors with MIL-5015 Inserts

The ACA-B is designed for commercial and Industrial environments requiring a rugged bayonet style connector for heavy duty power and signal applications. A comprehensive selection of insert arrangements and accessory hardware configurations are featured to accommodate heavy-duty, commercial wire and cable. ACA-B is manufacture in accordance with MIL-5015 and VG95234. Common applications include automation, machines toll, robotics, instrumentation, process control, material handling, and test & measurements.

Features of the Amphenol® ACA-B reverse bayonet coupling connectors with MIL-5015 insert patterns:

- Quick positive coupling; Audible and tactile indication of full coupling
- Waterproof
- No lockwiring required
- High shock and vibration capabilities
- Inserts available in Neoprene material (alternate insert materials available upon request)
- Operating temperature range with Neoprene inserts: -55°C to +125°C
- Available in both crimp and solder terminations
- Contacts available in gold and silver plating
- Numerous finishes available, Zinc alloy plating (cadmium free) available
- Rugged construction aluminum or stainless steel components
- Intermateable with existing VG95234 connectors
- 500 coupling minimum

See online (www.amphenol-industrial.com) or ask for Amphenol catalog 12-027, ACA-B Reverse Bayonet Connectors.



Amphe-Power™ 5015 Connectors

Amphenol offers the MIL-5015 connector family that can be enhanced with high amperage RADSOK® contacts. They use the AC threaded shells which are a MIL-5015 type.

Design characteristics of the Amphe-Power 5015 connectors are:

- The RADSOK contact handles up to 150% higher amperages than standard contacts
- The RADSOK contact has a twisted hyperbolic, stamped grid configuration within the socket. This design ensures a large, coaxial, face-to-face surface area engagement. As male pin is inserted, axial members in the female half deflect, imparting high current flow across the connection with minimal voltage loss.
- Contact arrangements have RADSOK sockets in sizes 0, 4 and 8 with standard contacts in sizes 16 and 12.

The contacts available in RADSOK and the amperages are as follows:

- Size 8 AWG can handle currents up to 69 amps.
- Size 4 AWG can handle currents up to 120 amps.
- Size 0 AWG can handle currents up to 250 amps.
- For availability of size 12 RADSOK that handles currents up to 35 amps, consult Amphenol.)
- AC threaded 5015 styles include: solid shell for general, non-environmental applications; pressurized style for use on pressurized bulkheads or pressure barriers; environmental resisting style with strain relief; lighter weight and shorter environmental resisting style

See online (www.amphenol-industrial.com) or ask for Amphenol brochure SL-391, Amphe-Power Connectors with RADSOK® technology.

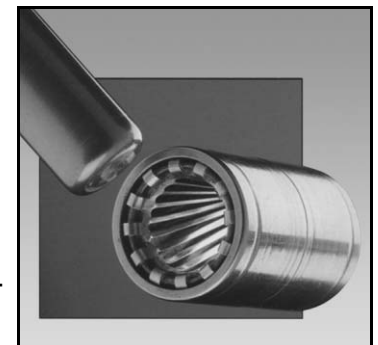

The RADSOK design - socket cylinder within female contact has twisted hyperbolic grid. Provides higher amperage capabilities with low insertion force and low temperature rise.



Стандарт Электрон Связь

Мы молодая и активно развивающаяся компания в области поставок электронных компонентов. Мы поставляем электронные компоненты отечественного и импортного производства напрямую от производителей и с крупнейших складов мира.

Благодаря сотрудничеству с мировыми поставщиками мы осуществляем комплексные и плановые поставки широчайшего спектра электронных компонентов.

Собственная эффективная логистика и склад в обеспечивает надежную поставку продукции в точно указанные сроки по всей России.

Мы осуществляем техническую поддержку нашим клиентам и предпродажную проверку качества продукции. На все поставляемые продукты мы предоставляем гарантию .

Осуществляем поставки продукции под контролем ВП МО РФ на предприятия военно-промышленного комплекса России , а также работаем в рамках 275 ФЗ с открытием отдельных счетов в уполномоченном банке. Система менеджмента качества компании соответствует требованиям ГОСТ ISO 9001.

Минимальные сроки поставки, гибкие цены, неограниченный ассортимент и индивидуальный подход к клиентам являются основой для выстраивания долгосрочного и эффективного сотрудничества с предприятиями радиоэлектронной промышленности, предприятиями ВПК и научно-исследовательскими институтами России.

С нами вы становитесь еще успешнее!

Наши контакты:

Телефон: +7 812 627 14 35

Электронная почта: sales@st-electron.ru

Адрес: 198099, Санкт-Петербург,
Промышленная ул, дом № 19, литера Н,
помещение 100-Н Офис 331