



## GaAs pHEMT MMIC LOW NOISE AMPLIFIER, 6 - 26.5 GHz

### Typical Applications

This HMC963LC4 is ideal for:

- Point-to-Point Radios
- Point-to-Multi-Point Radios
- Military & Space
- Test Instrumentation

### Features

- Low Noise Figure: 2.5 dB
- High Gain: 22 dB
- P1dB Output Power: 10 dBm
- Single Supply Voltage: +3.5V @ 45mA
- Output IP3: +18 dBm
- 50 Ohm matched Input/Output
- 24 Lead 4x4 mm SMT Package: 16mm<sup>2</sup>

### Functional Diagram

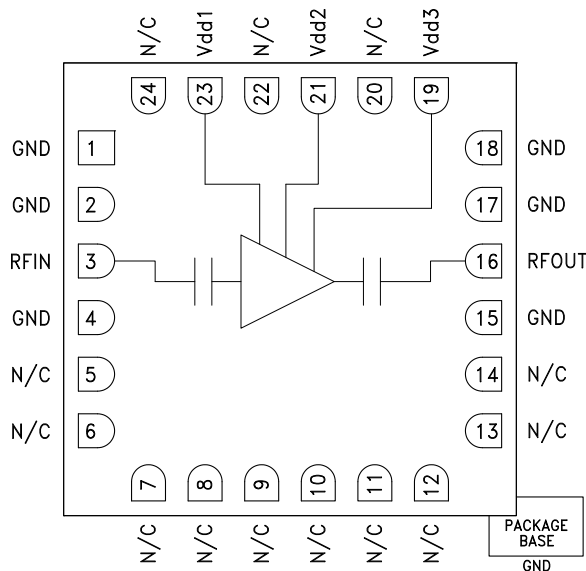

### General Description

The HMC963LC4 is a self-biased GaAs MMIC Low Noise Amplifier housed in a leadless 4x4 mm ceramic surface mount package. The amplifier operates between 6 and 26.5 GHz, providing 20 dB of small signal gain, 2.5 dB noise figure, and output IP3 of +18 dBm, while requiring only 45 mA from a +3.5 V supply. The P1dB output power of +10 dBm enables the LNA to function as a LO driver for balanced, I/Q or image reject mixers. The HMC963LC4 also features I/Os that are DC blocked and internally matched to 50 Ohms, making it ideal for high capacity microwave radios and VSAT applications.

### Electrical Specifications, $T_A = +25^\circ\text{C}$ , $V_{dd1} = V_{dd2} = +3.5\text{V}$ , $I_{dd} = 45\text{ mA}$

Parameter	Min.	Typ.	Max.	Units
Frequency Range	6 - 26.5			GHz
Gain	16.5	22		dB
Gain Variation over Temperature		0.03		dB / °C
Noise Figure [1]		2.5	3.5	dB
Input Return Loss		10		dB
Output Return Loss		10		dB
Output Power for 1 dB Compression	7	10		dBm
Saturated Output Power (P <sub>sat</sub> )		12		dBm
Output Third Order Intercept (IP3)		18		dBm
Supply Current (I <sub>dd</sub> ) (V <sub>dd</sub> = 3.5V, V <sub>gg1</sub> = V <sub>gg2</sub> = Open)		45	65	mA

[1] Board loss subtracted out.



**GaAs pHEMT MMIC LOW NOISE  
AMPLIFIER, 6 - 26.5 GHz**

**Broadband Gain & Return Loss**

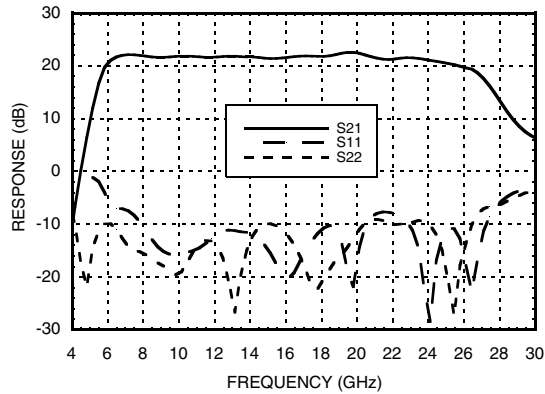

**Gain vs. Temperature**

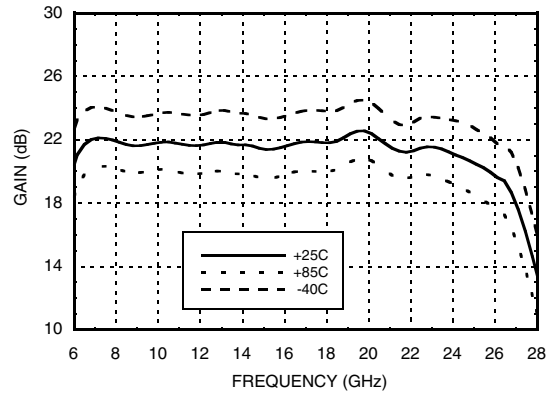

**Input Return Loss vs. Temperature**

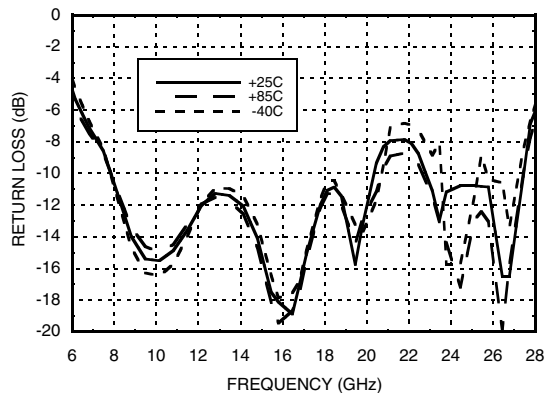

**Output Return Loss vs. Temperature**

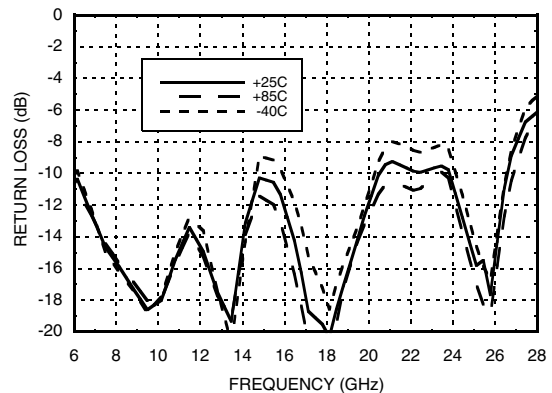

**Noise Figure vs. Temperature [1]**

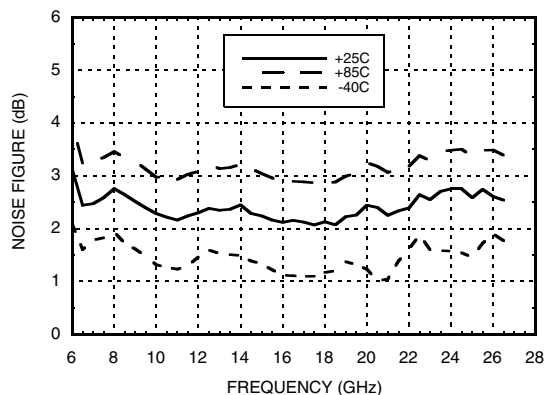

**Output IP3 vs. Temperature**

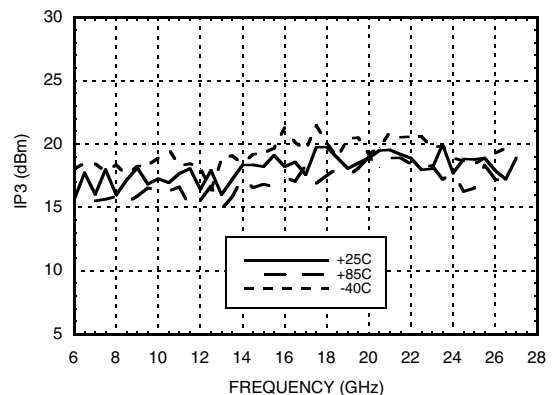

[1] Board loss subtracted out.



**GaAs pHEMT MMIC LOW NOISE AMPLIFIER, 6 - 26.5 GHz**

AMPLIFIERS - LOW NOISE - SMT

**P1dB vs. Temperature**

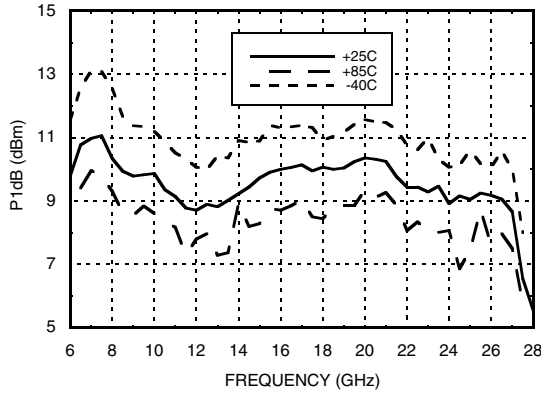

**Psat vs. Temperature**

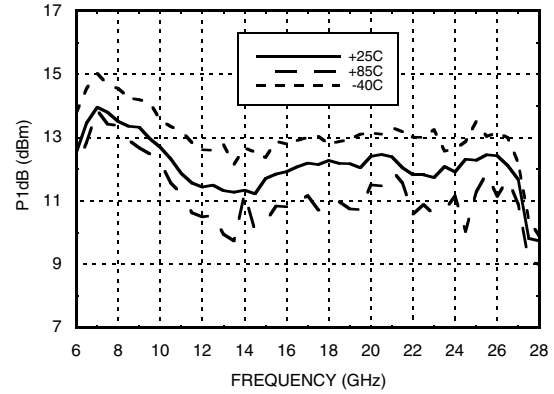

**Reverse Isolation vs. Temperature**

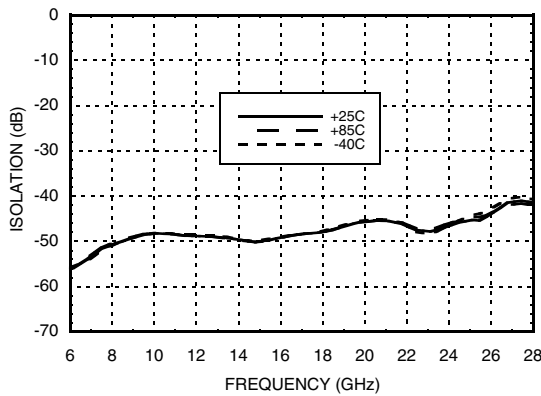

**Power Compression @ 8 GHz**

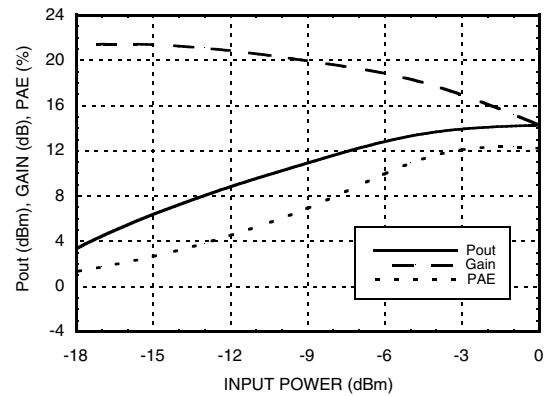

**Power Compression @ 16 GHz**

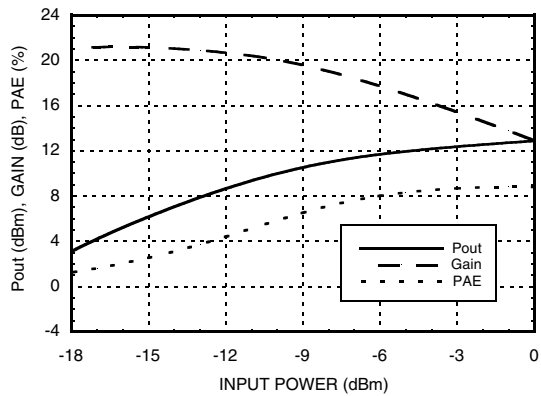

**Power Compression @ 24 GHz**

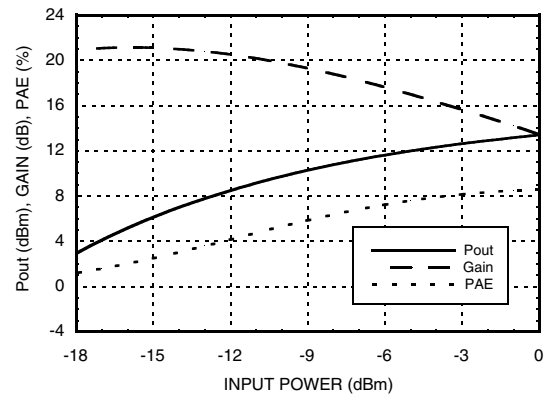

Information furnished by Analog Devices is believed to be accurate and reliable. However, no responsibility is assumed by Analog Devices for its use, nor for any infringements of patents or other rights of third parties that may result from its use. Specifications subject to change without notice. No license is granted by implication or otherwise under any patent or patent rights of Analog Devices. Trademarks and registered trademarks are the property of their respective owners.

For price, delivery, and to place orders: Analog Devices, Inc., One Technology Way, P.O. Box 9106, Norwood, MA 02062-9106 Phone: 781-329-4700 • Order online at [www.analog.com](http://www.analog.com) Application Support: Phone: 1-800-ANALOG-D



## GaAs pHEMT MMIC LOW NOISE AMPLIFIER, 6 - 26.5 GHz

### Current vs. Input Power @ 16 GHz

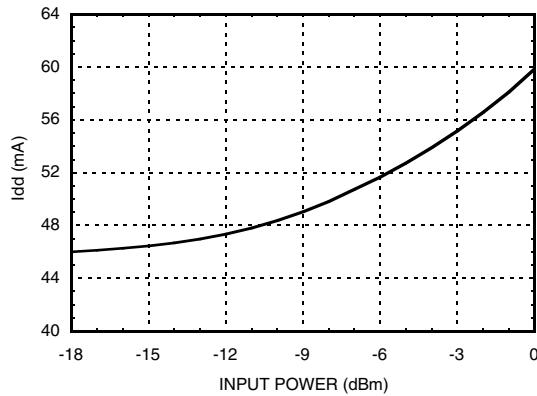

### Absolute Maximum Ratings

Drain Bias Voltage	+4V
RF Input Power	0 dBm
Channel Temperature	150 °C
Continuous Pdiss (T = 85 °C) (derate 8 mW/°C above 85 °C)	0.52 W
Thermal Resistance (Channel to ground paddle)	125 °C/W
Storage Temperature	-65 to +150 °C
Operating Temperature	-40 to +85 °C
ESD Sensitivity (HBM)	Class 0 <150 V



ELECTROSTATIC SENSITIVE DEVICE  
OBSERVE HANDLING PRECAUTIONS

### Outline Drawing

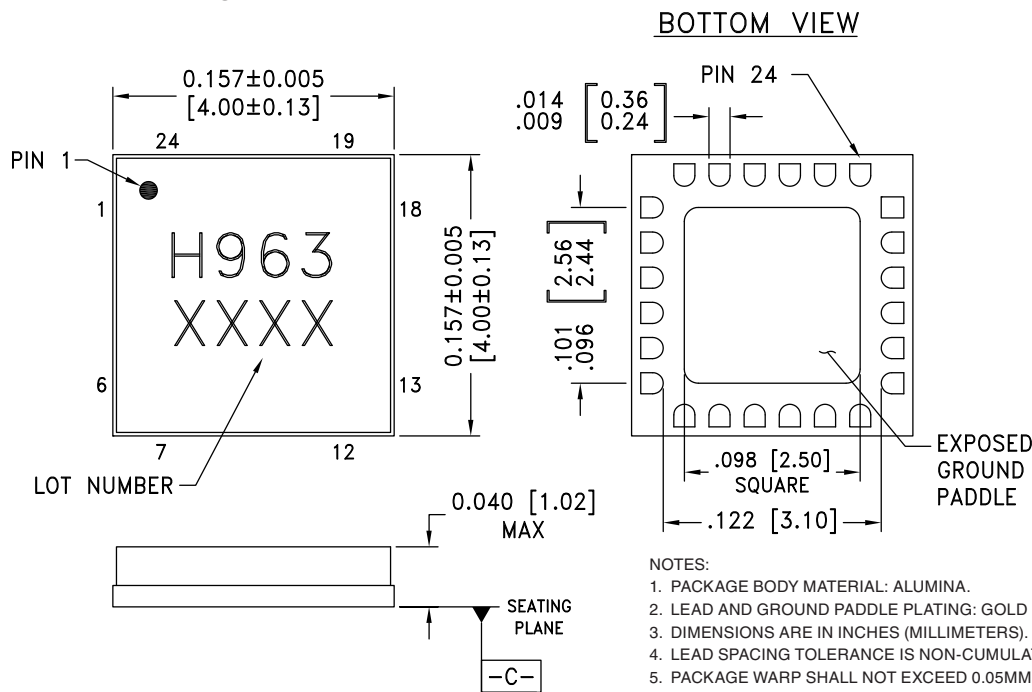

### Package Information

Part Number	Package Body Material	Lead Finish	MSL Rating	Package Marking <sup>[2]</sup>
HMC963LC4	Alumina, White	Gold over Nickel	MSL3 <sup>[1]</sup>	H963 XXXX

[1] Max peak reflow temperature of 260 °C

[2] 4-Digit lot number XXXX



## GaAs pHEMT MMIC LOW NOISE AMPLIFIER, 6 - 26.5 GHz

### Pin Descriptions

Pin Number	Function	Description	Interface Schematic
1, 2, 4, 15, 17, 18	GND	These pins and package bottom must be connected to RF/DC ground.	
3	RFIN	This pin AC coupled and matched to 50 Ohms	
5 - 14, 20, 22, 24	N/C	No connection necessary. These pins may be connected to RF/DC ground. Performance will not be affected.	
16	RFOUT	This pin AC coupled and matched to 50 Ohms	
19, 21, 23	Vdd1, Vdd2, Vdd3	Power supply voltages for the amplifier. Bypass capacitors are required. See application circuit herein.	

### Application Circuit

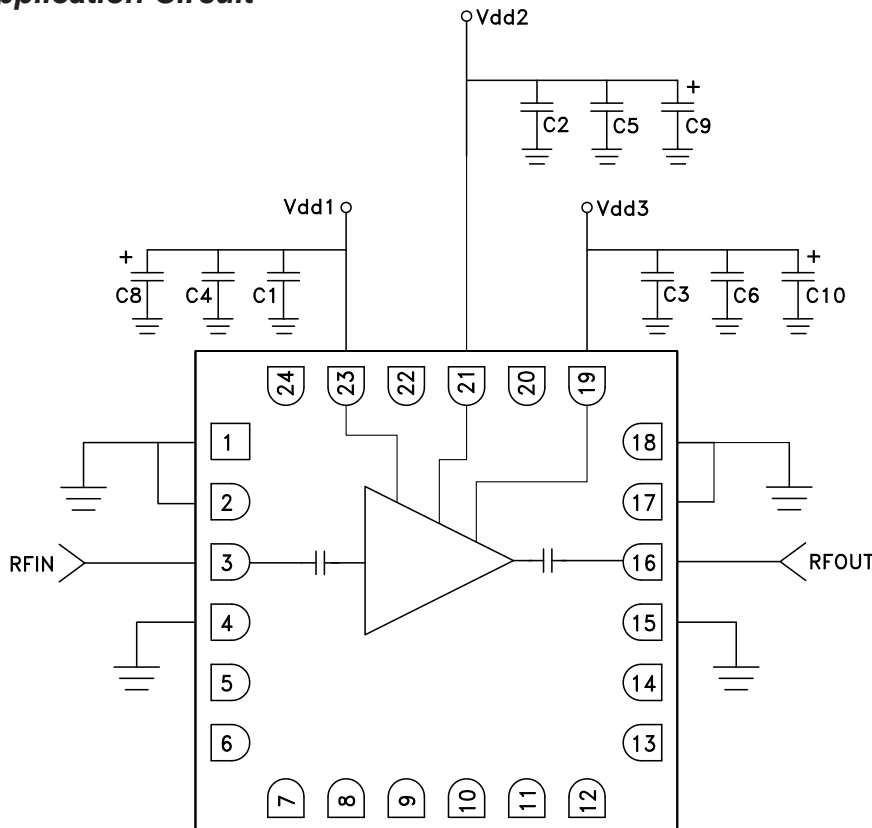

Capacitor	Value
C1 - C3	100 pF
C4 - C6	1000 pF
C8 - C10	2.2 μF

Information furnished by Analog Devices is believed to be accurate and reliable. However, no responsibility is assumed by Analog Devices for its use, nor for any infringements of patents or other rights of third parties that may result from its use. Specifications subject to change without notice. No license is granted by implication or otherwise under any patent or patent rights of Analog Devices. Trademarks and registered trademarks are the property of their respective owners.

For price, delivery, and to place orders: Analog Devices, Inc., One Technology Way, P.O. Box 9106, Norwood, MA 02062-9106 Phone: 781-329-4700 • Order online at [www.analog.com](http://www.analog.com) Application Support: Phone: 1-800-ANALOG-D

## GaAs pHEMT MMIC LOW NOISE AMPLIFIER, 6 - 26.5 GHz



### Evaluation PCB

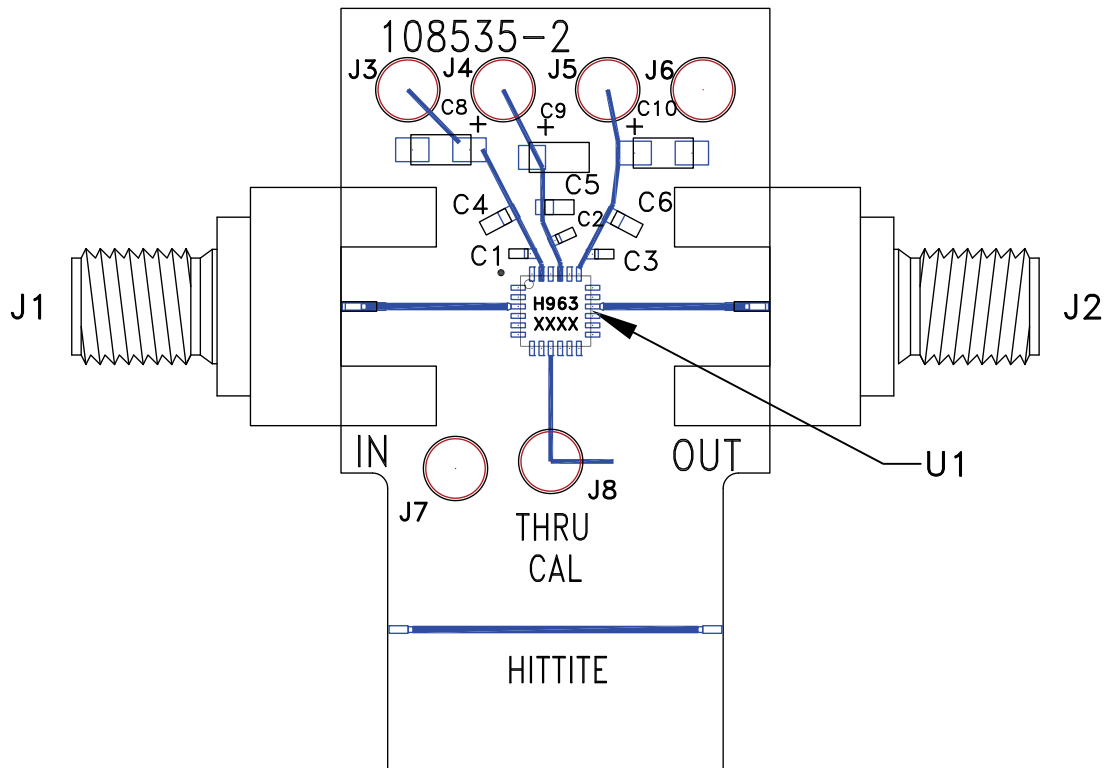

### List of Material for Evaluation PCB EVAL01-HMC963LC4 [1]

Item	Description
J1, J2	2.92 mm Connectors
J3 - J8	DC Pin
C1 - C3	100 pF Capacitor, 0402 Pkg.
C4 - C6	1000 pF Capacitor, 0603 Pkg.
C8 - C10	2.2 $\mu$ F Capacitor, Tantalum
U1	HMC963LC4 Amplifier
PCB [2]	108535 Evaluation PCB

[1] Reference this number when ordering complete evaluation PCB

[2] Circuit Board Material: Rogers 4350 or Arlon 25FR

The circuit board used in this application should use RF circuit design techniques. Signal lines should have 50 Ohm impedance while the package ground leads and exposed paddle should be connected directly to the ground plane similar to that shown. A sufficient number of via holes should be used to connect the top and bottom ground planes. The evaluation board should be mounted to an appropriate heat sink. The evaluation circuit board shown is available from Hittite upon request.



## Стандарт Электрон Связь

Мы молодая и активно развивающаяся компания в области поставок электронных компонентов. Мы поставляем электронные компоненты отечественного и импортного производства напрямую от производителей и с крупнейших складов мира.

Благодаря сотрудничеству с мировыми поставщиками мы осуществляем комплексные и плановые поставки широчайшего спектра электронных компонентов.

Собственная эффективная логистика и склад в обеспечивает надежную поставку продукции в точно указанные сроки по всей России.

Мы осуществляем техническую поддержку нашим клиентам и предпродажную проверку качества продукции. На все поставляемые продукты мы предоставляем гарантию .

Осуществляем поставки продукции под контролем ВП МО РФ на предприятия военно-промышленного комплекса России , а также работаем в рамках 275 ФЗ с открытием отдельных счетов в уполномоченном банке. Система менеджмента качества компании соответствует требованиям ГОСТ ISO 9001.

Минимальные сроки поставки, гибкие цены, неограниченный ассортимент и индивидуальный подход к клиентам являются основой для выстраивания долгосрочного и эффективного сотрудничества с предприятиями радиоэлектронной промышленности, предприятиями ВПК и научно-исследовательскими институтами России.

С нами вы становитесь еще успешнее!

### Наши контакты:

**Телефон:** +7 812 627 14 35

**Электронная почта:** [sales@st-electron.ru](mailto:sales@st-electron.ru)

**Адрес:** 198099, Санкт-Петербург,  
Промышленная ул, дом № 19, литера Н,  
помещение 100-Н Офис 331