

# Power TOPLED® Enhanced optical Power LED (HOP2000)

LS E67B, LA E67B, LO E67B, LY E67B



## Vorläufige Daten / Preliminary Data

### Besondere Merkmale

- **Gehäusetyp:** weißes P-LCC-4 Gehäuse
- **Besonderheit des Bauteils:** mehr Licht durch erhöhten optischen Wirkungsgrad; höhere Umgebungstemperatur bei gleichem Strom im Vergleich zur TOPLED®
- **Wellenlänge:** 633 nm (super-rot), 617 nm (amber), 606 nm (orange), 587 nm (gelb)
- **Abstrahlwinkel:** Lambertscher Strahler (120°)
- **Technologie:** InGaAlP
- **optischer Wirkungsgrad:** 24 lm/W (amber, orange, gelb), 18 lm/W (super-rot)
- **Gruppierungsparameter:** Lichtstärke, Durchflussspannung, Wellenlänge
- **Verarbeitungsmethode:** für alle SMT-Bestücktechniken geeignet
- **Lötmethode:** IR Reflow Löten und Wellenlöten (TTW)
- **Vorbehandlung:** nach JEDEC Level 2
- **Gurtung:** 8 mm Gurt mit 2000/Rolle, ø180 mm oder 8000/Rolle, ø330 mm
- **ESD-Festigkeit:** ESD-sicher bis 2 kV nach EOS/ESD-5.1-1993

### Anwendungen

- Ampelanwendung
- Hinterleuchtung (LCD, Schalter, Tasten, Displays, Werbebeleuchtung)
- Innen- und Außenbeleuchtung im Automobilbereich (z.B. Instrumentenbeleuchtung, Blinker, seitl. Begrenzungsleuchten, Bremslichter)
- Ersatz von Kleinst-Glühlampen
- Markierungsbeleuchtung (z.B. Fluchtwege, u.ä.)
- Signal- und Symbolleuchten

### Features

- **package:** white P-LCC-4 package
- **feature of the device:** more light due to higher optical efficiency, higher ambient temperature at the same current possible compared to TOPLED®
- **wavelength:** 633 nm (super-red), 617 nm (amber), 606 nm (orange), 587 nm (gelb)
- **viewing angle:** Lambertian Emitter (120°)
- **technology:** InGaAlP
- **optical efficiency:** 24 lm/W (amber, orange, yellow), 18 lm/W (super-red)
- **grouping parameter:** luminous intensity, forward voltage, wavelength
- **assembly methods:** suitable for all SMT assembly methods
- **soldering methods:** IR reflow soldering and TTW soldering
- **preconditioning:** acc. to JEDEC Level 2
- **taping:** 8 mm tape with 2000/reel, ø180 mm or 8000/reel, ø330 mm
- **ESD-withstand voltage:** up to 2 kV acc. to EOS/ESD-5.1-1993

### Applications

- traffic lights
- backlighting (LCD, switches, keys, displays, illuminated advertising)
- interior and exterior automotive lighting (e.g. dashboard backlighting, turn signal lamps, sidemarkers, brake lights)
- substitution of micro incandescent lamps
- marker lights (e.g. exit ways, etc.)
- signal and symbol luminaire

Typ	Emissions- farbe	Farbe der Lichtaustritts- fläche	Lichtstärke	Lichtstrom	Bestellnummer
Type	Color of Emission	Color of the Light Emitting Area	Luminous Intensity $I_F = 50 \text{ mA}$ $I_V \text{ (mcd)}$	Luminous Flux $I_F = 50 \text{ mA}$ $\Phi_V \text{ (mlm)}$	Ordering Code
LS E67B-T2V1-1-1	super-red	colorless clear	355 ... 900	1900 (typ.)	Q65110A0178
LA E67B-U2AA-24-1	amber	colorless clear	560 ... 1400	2900 (typ.)	Q62703Q5965
LO E67B-U2AA-24-1	orange	colorless clear	560 ... 1400	2900 (typ.)	Q62703Q6010
LY E67B-U2AA-26-1	yellow	colorless clear	560 ... 1400	2900 (typ.)	Q62703Q6329

Anm.: -1-1 gesamter Farbbereich (siehe **Seite 4**)

-24-1 gesamter Farbbereich, Lieferung in Einzelgruppen (siehe **Seite 5**)

-26-1 gesamter Farbbereich, Lieferung in Einzelgruppen (siehe **Seite 5**)

-24-1 gesamter Durchlassspannungsbereich, Lieferung in Einzelgruppen (siehe **Seite 5**)

-26-1 gesamter Durchlassspannungsbereich, Lieferung in Einzelgruppen (siehe **Seite 5**)

Die Standardlieferform von Serientypen beinhaltet eine Familiengruppe, die aus nur 4 Halbgruppen besteht. Einzelne Halbgruppen sind nicht erhältlich.

In einer Verpackungseinheit / Gurt ist immer nur eine Halbgruppe enthalten.

Dimmverhältnis im Gleichstrom-Betrieb max. 5:1

Note: -1-1 Total color tolerance range (please see **page 4**)

-24-1 Total color tolerance range, delivery in single groups (please see **page 5**)

-26-1 Total color tolerance range, delivery in single groups (please see **page 5**)

-24-1 Total forward voltage tolerance, delivery in single groups (see **page 5**)

-26-1 Total forward voltage tolerance, delivery in single groups (see **page 5**)

The standard shipping format for serial types includes a group of only 4 individual groups. Individual half groups are not available.

No packing unit / tape ever contains more than one luminous intensity half group.

Dimming range for direct current mode max. 5:1

**Grenzwerte**  
**Maximum Ratings**

Bezeichnung Parameter	Symbol Symbol	Wert Value	Einheit Unit
Betriebstemperatur Operating temperature range	$T_{op}$	- 40 ... + 100	°C
Lagertemperatur Storage temperature range	$T_{stg}$	- 40 ... + 100	°C
Sperrschichttemperatur Junction temperature	$T_j$	+ 125	°C
Durchlassstrom Forward current	$I_F$	70	mA
Stoßstrom Surge current $t \leq 10 \mu s, D = 0.1$	$I_{FM}$	0.1	A
Sperrspannung <sup>1)</sup> Reverse voltage	$V_R$	12	V
Leistungsaufnahme Power consumption	$P_{tot}$	180	mW
Wärmewiderstand Thermal resistance Sperrschicht/Umgebung Junction/ambient	$R_{th JA}$	300	K/W
Sperrschicht/Lötpad Junction/soldering point Montage auf PC-Board FR 4 (Padgröße $\geq 16 \text{ mm}^2$ ) mounted on PC board FR 4 (pad size $\geq 16 \text{ mm}^2$ )	$R_{th JS}$	130	K/W

<sup>1)</sup> für kurzzeitigen Betrieb geeignet / suitable for short term application

**Kennwerte** ( $T_A = 25\text{ °C}$ )

**Characteristics**

Bezeichnung Parameter	Symbol Symbol	Werte Values				Einheit Unit
		LS	LA	LO	LY	
Wellenlänge des emittierten Lichtes (typ.) Wavelength at peak emission $I_F = 50\text{ mA}$	$\lambda_{\text{peak}}$	645	624	610	594	nm
Dominantwellenlänge <sup>1)</sup> (typ.) Dominant wavelength $I_F = 50\text{ mA}$	$\lambda_{\text{dom}}$	633 ± 6	617 -5/+7	606 -6/+3	587 -7/+8	nm
Spektrale Bandbreite bei 50 % $I_{\text{rel max}}$ (typ.) Spectral bandwidth at 50 % $I_{\text{rel max}}$ $I_F = 50\text{ mA}$	$\Delta\lambda$	15	18	16	15	nm
Abstrahlwinkel bei 50 % $I_V$ (Vollwinkel) (typ.) Viewing angle at 50 % $I_V$	$2\phi$	120	120	120	120	Grad deg.
Durchlassspannung <sup>2)</sup> (min.) Forward voltage (typ.) $I_F = 50\text{ mA}$ (max.)	$V_F$	1.9 <sup>3)</sup>	1.9 <sup>4)</sup>	1.9	1.9 <sup>3)</sup>	V
	$V_F$	2.2	2.2	2.2	2.2	V
	$V_F$	2.5	2.5	2.5	2.5	V
Sperrstrom (typ.) Reverse current (max.) $V_R = 12\text{ V}$	$I_R$	0.01	0.01	0.01	0.01	$\mu\text{A}$
	$I_R$	10	10	10	10	$\mu\text{A}$
Temperaturkoeffizient von $\lambda_{\text{peak}}$ (typ.) Temperature coefficient of $\lambda_{\text{peak}}$ $I_F = 50\text{ mA}; -10\text{ °C} \leq T \leq 100\text{ °C}$	$TC_{\lambda_{\text{peak}}}$	0.15	0.15	0.14	0.13	nm/K
Temperaturkoeffizient von $\lambda_{\text{dom}}$ (typ.) Temperature coefficient of $\lambda_{\text{dom}}$ $I_F = 50\text{ mA}; -10\text{ °C} \leq T \leq 100\text{ °C}$	$TC_{\lambda_{\text{dom}}}$	0.05	0.07	0.08	0.10	nm/K
Temperaturkoeffizient von $V_F$ (typ.) Temperature coefficient of $V_F$ $I_F = 50\text{ mA}; -10\text{ °C} \leq T \leq 100\text{ °C}$	$TC_V$	- 3.4	- 3.7	- 3.7	- 3.7	mV/K
Optischer Wirkungsgrad (typ.) Optical efficiency $I_F = 50\text{ mA}$	$\eta_{\text{opt}}$	18	24	24	24	lm/W

<sup>1)</sup> Wellenlängen werden mit einer Stromeinprägedauer von 25 ms und einer Genauigkeit von  $\pm 1\text{ nm}$  ermittelt.  
Wavelengths are tested at a current pulse duration of 25 ms and a tolerance of  $\pm 1\text{ nm}$ .

<sup>2)</sup> Durchlassspannungsgruppen werden mit einer Stromeinprägedauer von 1 ms und einer Genauigkeit von  $\pm 0,05\text{ V}$  ermittelt.  
Forward voltage groups are tested at a current pulse duration of 1 ms and a tolerance of  $\pm 0.05\text{ V}$ .

1) Wellenlängengruppen  
Wavelength groups

Gruppe Group	amber		orange		yellow		Einheit Unit
	min.	max.	min.	max.	min.	max.	
2	612	616	600	603	580	583	nm
3	616	620	603	606	583	586	nm
4	620	624	606	609	586	589	nm
5					589	592	nm
6					592	595	nm

3) Durchlassspannungsgruppen für  
super-rot / orange / gelb  
Forward voltage groups for  
super-red / orange / yellow

Gruppe Group	Durchlassspannung Forward voltage		Einheit Unit
	min.	max.	
3	1.9	2.2	V
4	2.2	2.5	V

4) Durchlassspannungsgruppen für amber  
Forward voltage groups for amber

Gruppe Group	Durchlassspannung Forward voltage		Einheit Unit
	min.	max.	
3A	1.90	2.05	V
3B	2.05	2.20	V
4A	2.20	2.35	V
4B	2.35	2.50	V

Helligkeits-Gruppierungsschema  
Luminous Intensity Groups

Lichtgruppe Luminous Intensity Group	Lichtstärke Luminous Intensity $I_V$ (mcd)	Lichtstrom Luminous Flux $\Phi_V$ (lm)
T2	355 ... 450	1200 (typ.)
U1	450 ... 560	1500 (typ.)
U2	560 ... 710	1900 (typ.)
V1	710 ... 900	2400 (typ.)
V2	900 ... 1120	3000 (typ.)
AA	1120 ... 1400	3750 (typ.)

Helligkeitswerte werden mit einer Stromeinprägedauer von 25 ms und einer Genauigkeit von  $\pm 11\%$  ermittelt.  
Luminous intensity is tested at a current pulse duration of 25 ms and a tolerance of  $\pm 11\%$ .

Gruppenbezeichnung auf Etikett  
Group Name on Label

Beispiel: AA-3-4A  
Example: AA-3-4A

Lichtgruppe Luminous Intensity Group	Halbgruppe Half Group	Wellenlänge Wavelength	Durchlassspannung Forward Voltage
A	A	3	4A

Relative spektrale Emission  $I_{rel} = f(\lambda)$ ,  $T_A = 25\text{ °C}$ ,  $I_F = 50\text{ mA}$

**Relative Spectral Emission**

$V(\lambda)$  = spektrale Augenempfindlichkeit

Standard eye response curve

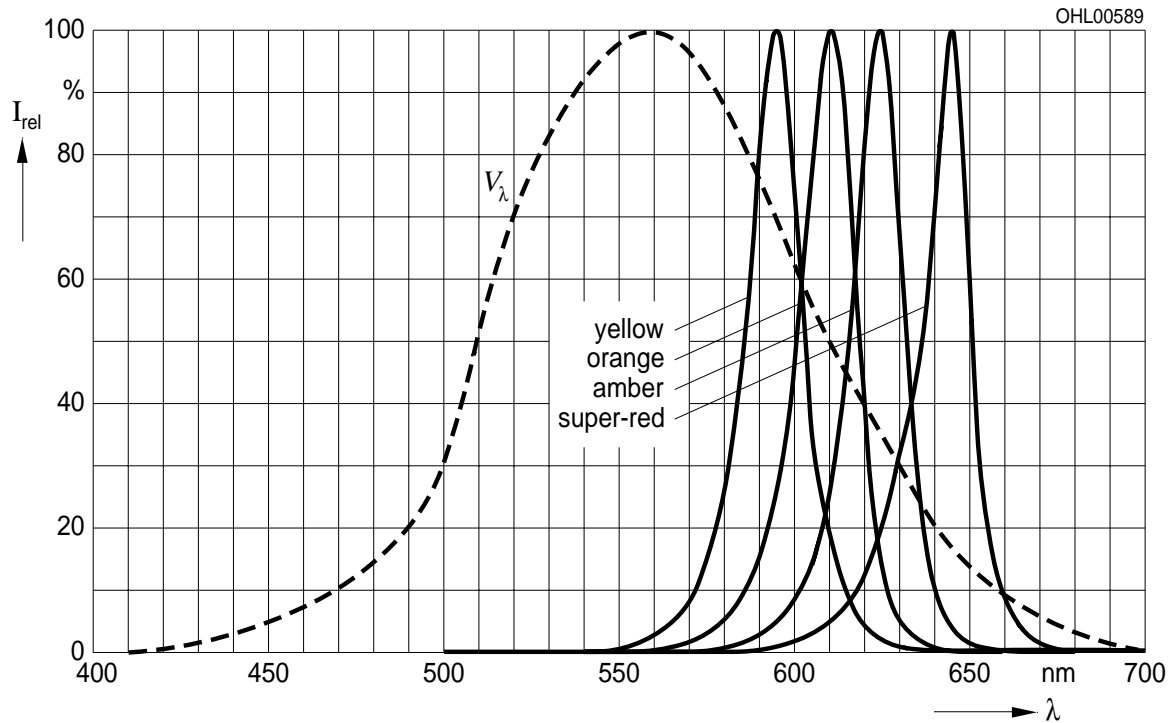

Abstrahlcharakteristik  $I_{rel} = f(\varphi)$

**Radiation Characteristic**

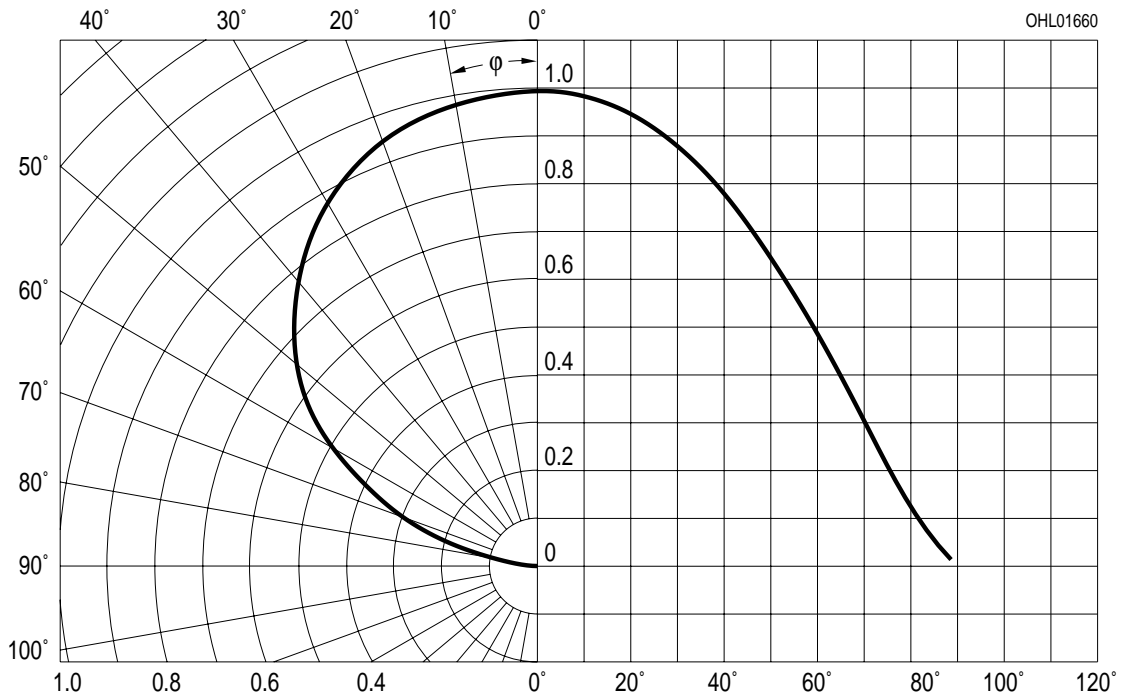

**Durchlassstrom  $I_F = f(V_F)$**   
**Forward Current**

$T_A = 25\text{ °C}$

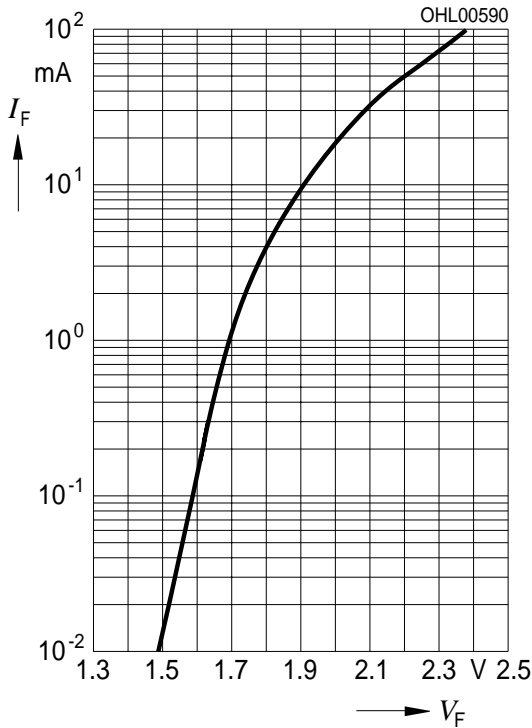

**Relative Lichtstärke  $I_V/I_{V(50\text{ mA})} = f(I_F)$**   
**Relative Luminous Intensity**

$T_A = 25\text{ °C}$

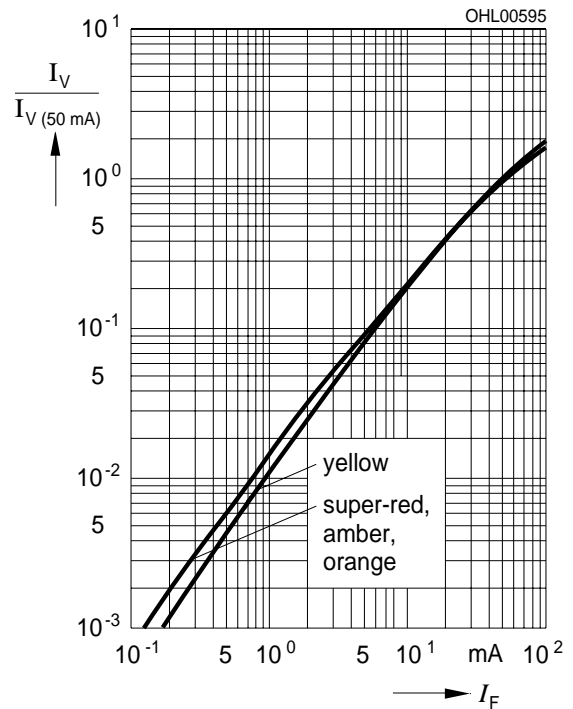

**Maximal zulässiger Durchlassstrom  $I_F = f(T)$**   
**Max. Permissible Forward Current**

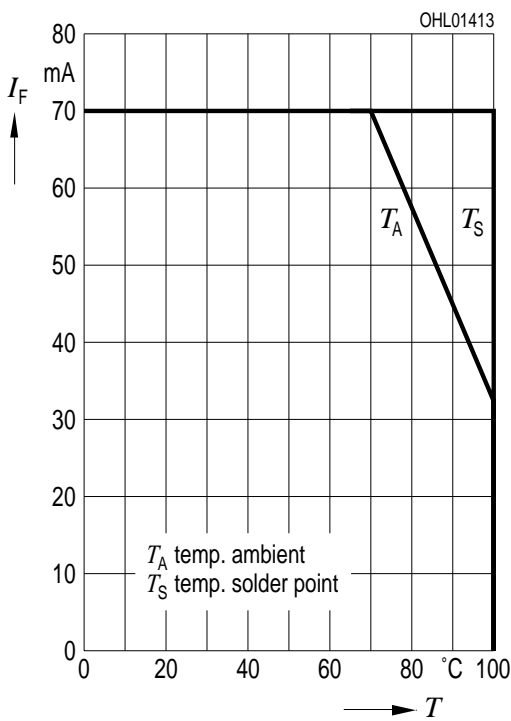

**Relative Lichtstärke  $I_V/I_{V(25\text{ °C})} = f(T_A)$**   
**Relative Luminous Intensity**

$I_F = 50\text{ mA}$

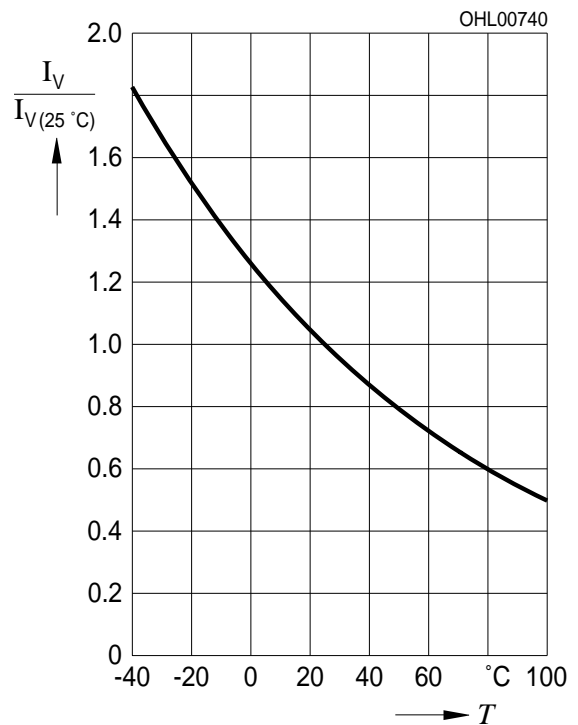

**Zulässige Impulsbelastbarkeit  $I_F = f(t_p)$**   
**Permissible Pulse Handling Capability**  
 Duty cycle  $D =$  parameter,  $T_A = 25\text{ °C}$

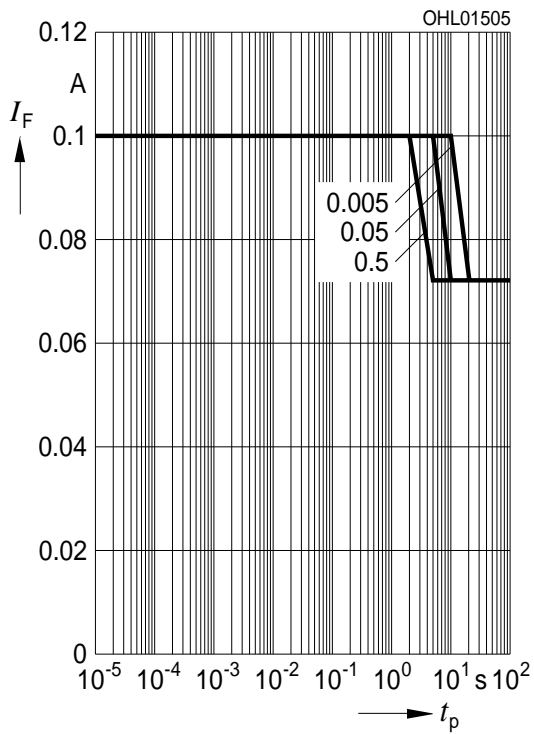

**Zulässige Impulsbelastbarkeit  $I_F = f(t_p)$**   
**Permissible Pulse Handling Capability**  
 Duty cycle  $D =$  parameter,  $T_A = 85\text{ °C}$

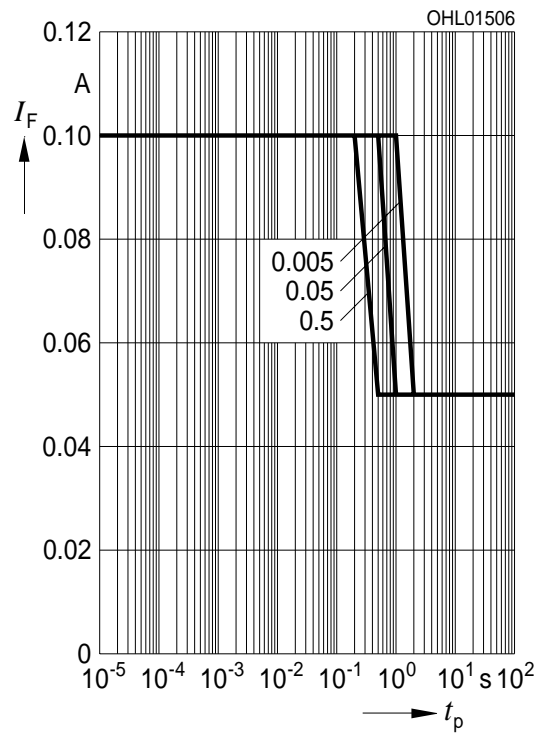



Maßzeichnung  
Package Outlines

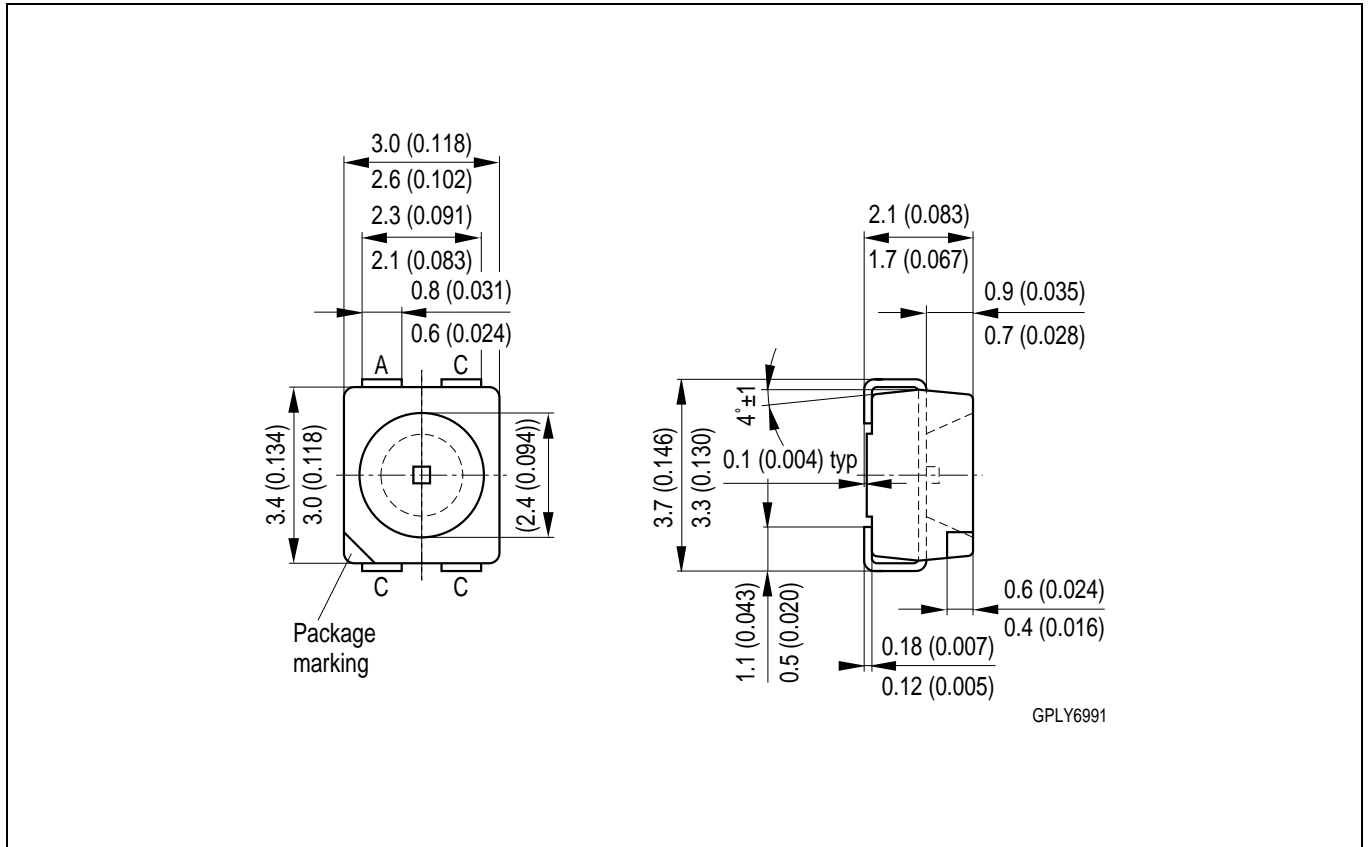

Maße werden wie folgt angegeben: mm (inch) / Dimensions are specified as follows: mm (inch).

Gewicht / Approx. weight: 35 mg

**Lötbedingungen** Vorbehandlung nach JEDEC Level 2  
**Soldering Conditions** Preconditioning acc. to JEDEC Level 2

**IR-Reflow Lötprofil** (nach IPC 9501)  
**IR Reflow Soldering Profile** (acc. to IPC 9501)

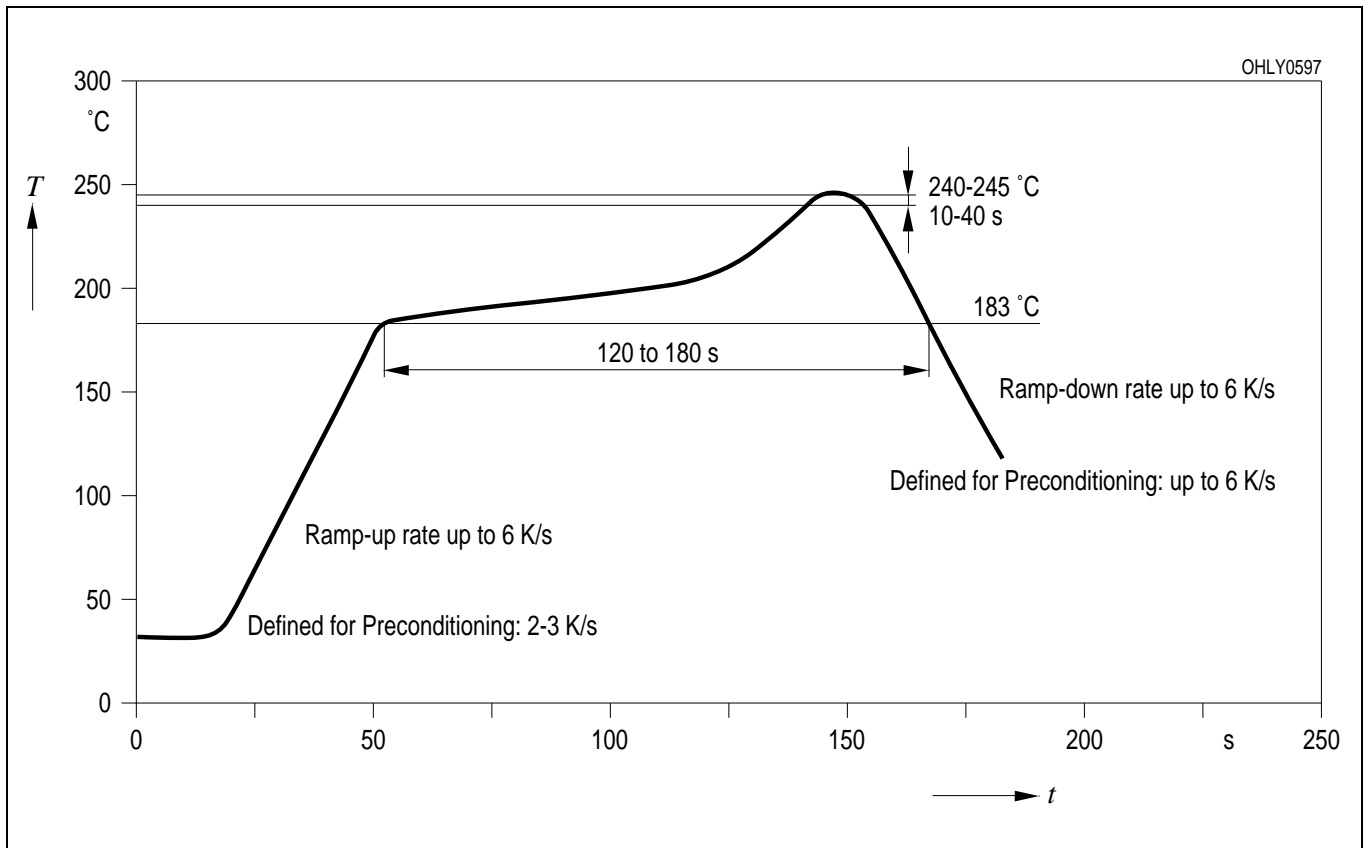

**Wellenlötten (TTW)** (nach CECC 00802)  
**TTW Soldering** (acc. to CECC 00802)

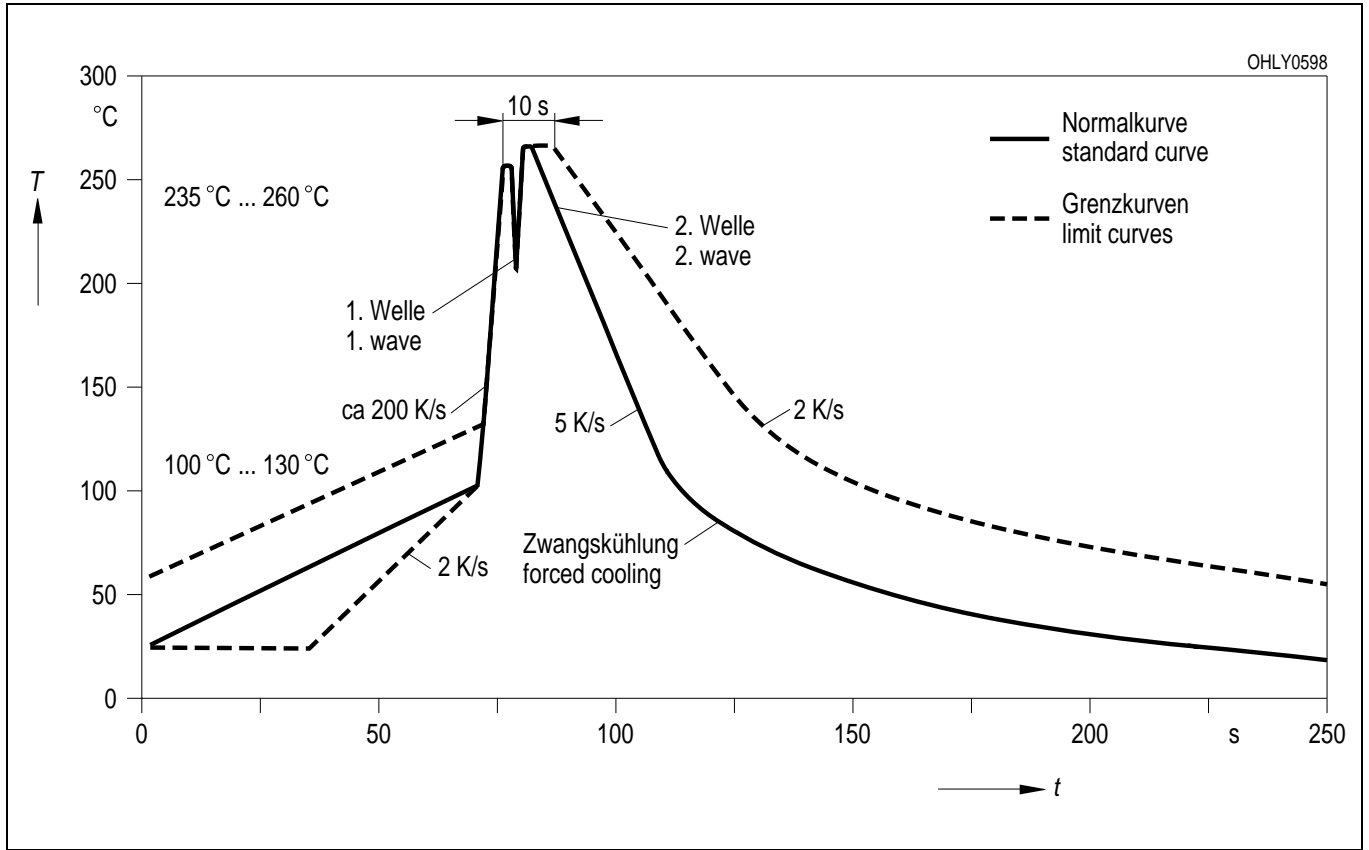

**Empfohlenes Lötpad Design** IR Reflow Lötten  
**Recommended Solder Pad** IR Reflow Soldering

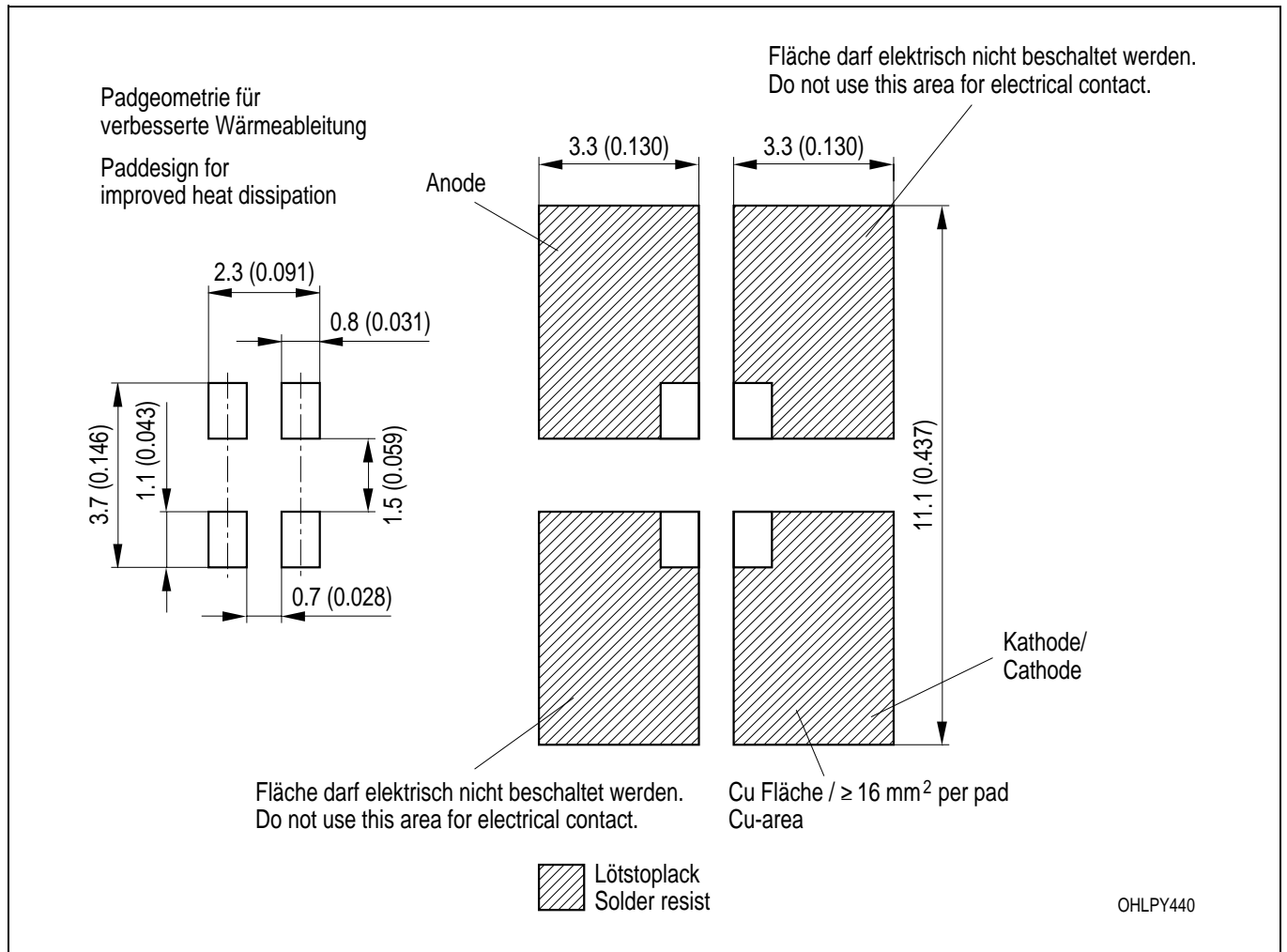

Maße werden wie folgt angegeben: mm (inch) / Dimensions are specified as follows: mm (inch).

**Empfohlenes Lötpad Design** Wellenlöten (TTW)  
**Recommended Solder Pad** TTW Soldering

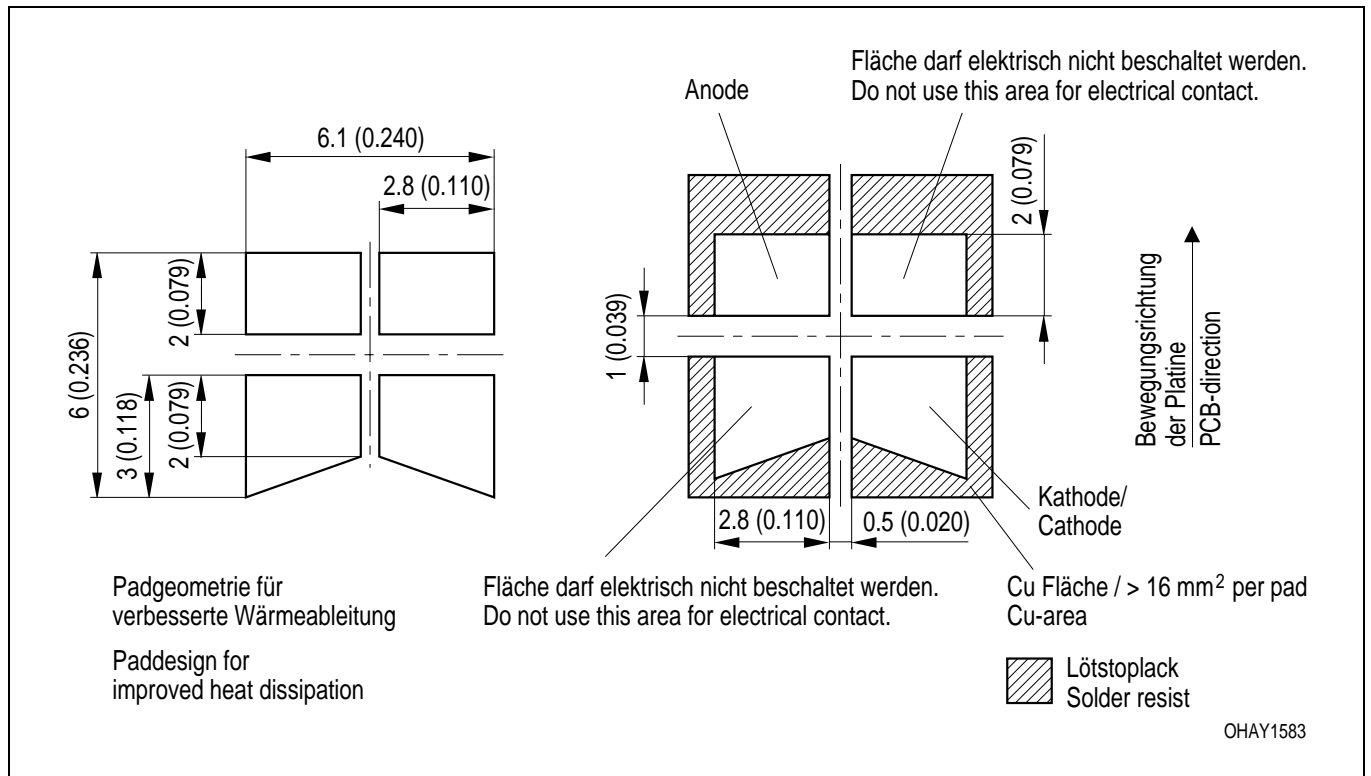

Maße werden wie folgt angegeben: mm (inch) / Dimensions are specified as follows: mm (inch).

**Gurtung / Polarität und Lage**

Verpackungseinheit 2000/Rolle, ø180 mm  
 oder 8000/Rolle, ø330 mm

**Method of Taping / Polarity and Orientation**

Packing unit 2000/reel, ø180 mm  
 or 8000/reel, ø330 mm

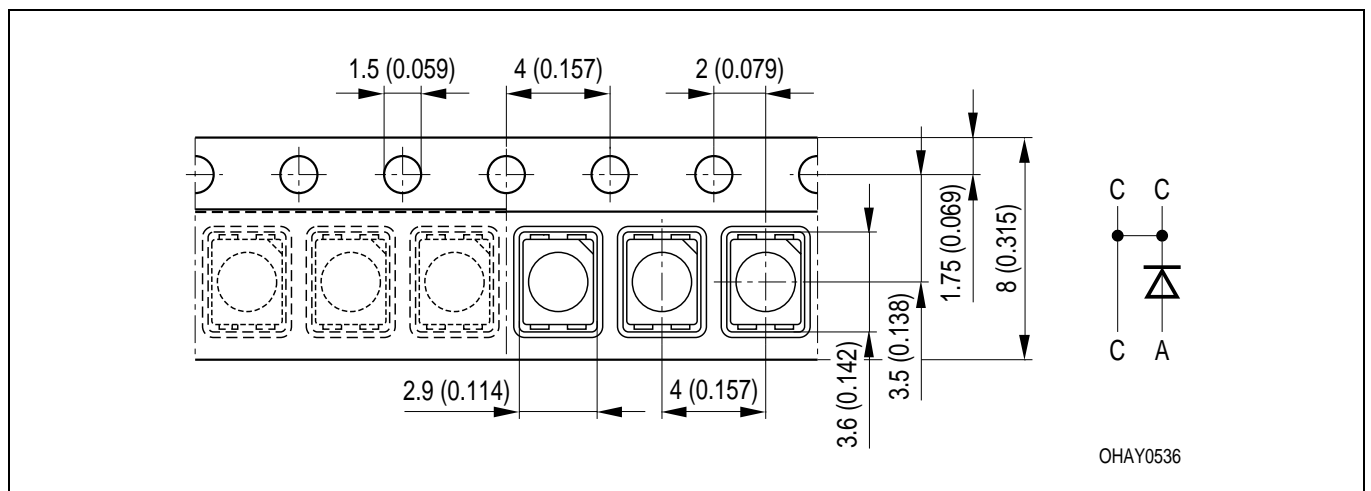

Maße werden wie folgt angegeben: mm (inch) / Dimensions are specified as follows: mm (inch).

Revision History: 2003-05-26		Date of change
Previous Version: 2003-03-04		
Page	Subjects (major changes since last revision)	
2	wavelength grouping for yellow, amber and orange	
2	forward voltage grouping for yellow, amber and super-red	
7	change of diagram rel. lum. intensity ( $T_A$ ) from OHL00569 to OHL00740	
4	value (orange; temperature coefficient of $V_F$ from -1.8 to -3.7 mV/K)	2002-06-14
14	annotations	2002-07-25
4	value ( $TC_{\lambda_{dom}}$ from 0.04 to 0.05 nm/K)	2002-07-25
12	new IR solder pad (OHLPY439 to OHLPY440)	2002-08-05
3, 4	value (reverse voltage from 5 V to 12 V)	2002-09-18
5	forward voltage groups for orange	2002-10-25
2	ordering code for super-red	2003-02-11
13	new recommended solder pad	2003-05-26

Published by OSRAM Opto Semiconductors GmbH  
 Wernerwerkstrasse 2, D-93049 Regensburg  
 © All Rights Reserved.

**Attention please!**

The information describes the type of component and shall not be considered as assured characteristics.

All typical data and graphs are basing on representative samples, but don't represent the production range. If requested, e.g. because of technical improvements, these typ. data will be changed without any further notice.

Terms of delivery and rights to change design reserved. Due to technical requirements components may contain dangerous substances. For information on the types in question please contact our Sales Organization.

If printed or downloaded, please find the latest version in the Internet.

**Packing**

Please use the recycling operators known to you. We can also help you – get in touch with your nearest sales office. By agreement we will take packing material back, if it is sorted. You must bear the costs of transport. For packing material that is returned to us unsorted or which we are not obliged to accept, we shall have to invoice you for any costs incurred.

**Components used in life-support devices or systems must be expressly authorized for such purpose!** Critical components <sup>1</sup> may only be used in life-support devices or systems <sup>2</sup> with the express written approval of OSRAM OS.

<sup>1</sup> A critical component is a component used in a life-support device or system whose failure can reasonably be expected to cause the failure of that life-support device or system, or to affect its safety or the effectiveness of that device or system.

<sup>2</sup> Life support devices or systems are intended (a) to be implanted in the human body, or (b) to support and/or maintain and sustain human life. If they fail, it is reasonable to assume that the health of the user may be endangered.



## Стандарт Электрон Связь

Мы молодая и активно развивающаяся компания в области поставок электронных компонентов. Мы поставляем электронные компоненты отечественного и импортного производства напрямую от производителей и с крупнейших складов мира.

Благодаря сотрудничеству с мировыми поставщиками мы осуществляем комплексные и плановые поставки широчайшего спектра электронных компонентов.

Собственная эффективная логистика и склад в обеспечивает надежную поставку продукции в точно указанные сроки по всей России.

Мы осуществляем техническую поддержку нашим клиентам и предпродажную проверку качества продукции. На все поставляемые продукты мы предоставляем гарантию .

Осуществляем поставки продукции под контролем ВП МО РФ на предприятия военно-промышленного комплекса России , а также работаем в рамках 275 ФЗ с открытием отдельных счетов в уполномоченном банке. Система менеджмента качества компании соответствует требованиям ГОСТ ISO 9001.

Минимальные сроки поставки, гибкие цены, неограниченный ассортимент и индивидуальный подход к клиентам являются основой для выстраивания долгосрочного и эффективного сотрудничества с предприятиями радиоэлектронной промышленности, предприятиями ВПК и научно-исследовательскими институтами России.

С нами вы становитесь еще успешнее!

### Наши контакты:

**Телефон:** +7 812 627 14 35

**Электронная почта:** [sales@st-electron.ru](mailto:sales@st-electron.ru)

**Адрес:** 198099, Санкт-Петербург,  
Промышленная ул, дом № 19, литера Н,  
помещение 100-Н Офис 331