

Description

The Advanced, Ultra Low Power (AUP) CMOS logic family is designed for low power and extended battery life in portable applications.

The 74AUP1G07 is a single buffer-gate, with an open drain output designed for operation over a power supply range of 0.8V to 3.6V.

The device is fully specified for partial power down applications using I_{OFF}. The I_{OFF} circuitry disables the output preventing damaging current backflow when the device is powered down. The gate performs the positive Boolean function:

$$Y = A$$

Features

- Advanced Ultra Low Power (AUP) CMOS
- Supply Voltage Range from 0.8V to 3.6V
- 4 mA Output Drive at 3.0V
- Low Static Power Consumption
I_{CC} < 0.9µA
- Low Dynamic Power Consumption
C_{PD} = 6pF (Typical at 3.6V)
- Schmitt Trigger Action at all inputs makes the circuit tolerant for slower input rise and fall time. The hysteresis is typically 250 mV at V_{CC} = 3.0V.
- I_{OFF} Supports Partial-Power-Down Mode Operation
- ESD Protection Exceeds JESD 22
2000-V Human Body Model (A114)
Exceeds 1000-V Charged Device Model (C101)
- Latch-Up Exceeds 100mA per JESD 78, Class I
- Leadless Packages Named per JESD30E
- **Totally Lead-Free & Fully RoHS Compliant (Notes 1 & 2)**
- **Halogen and Antimony Free. "Green" Device (Note 3)**

- Notes:
1. No purposely added lead. Fully EU Directive 2002/95/EC (RoHS) & 2011/65/EU (RoHS 2) compliant.
 2. See http://www.diodes.com/quality/lead_free.html for more information about Diodes Incorporated's definitions of Halogen- and Antimony-free "Green" and Lead-free.
 3. Halogen- and Antimony-free "Green" products are defined as those which contain <900ppm bromine, <900ppm chlorine (<1500ppm total Br + Cl) and <1000ppm antimony compounds.

Pin Assignments

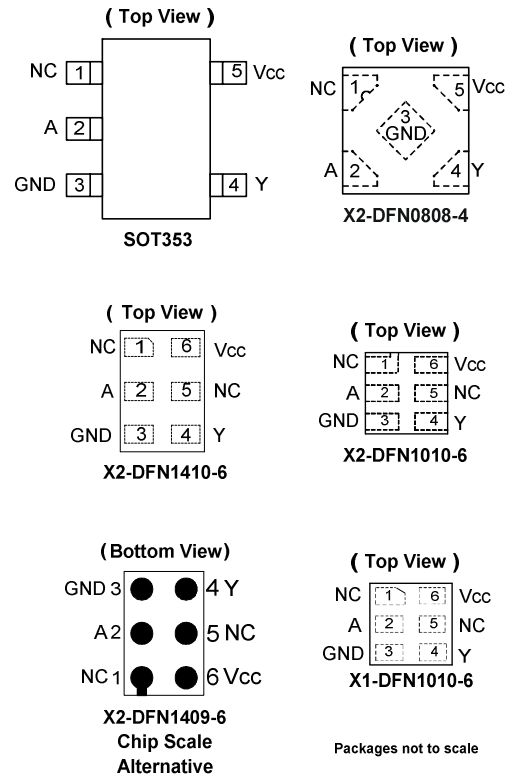

Applications

- Suited for Battery and Low Power Needs
- Wide array of products such as:
 - Tablets, E-readers
 - Cell Phones, Personal Navigation / GPS
 - MP3 Players, Cameras, Video Recorders
 - PCs, Ultrabooks, Notebooks, Netbooks
 - Computer Peripherals, Hard Drives, SSDs, CD/DVD ROMs
 - TVs, DVDs, DVRs, Set-Top Boxes

Ordering Information

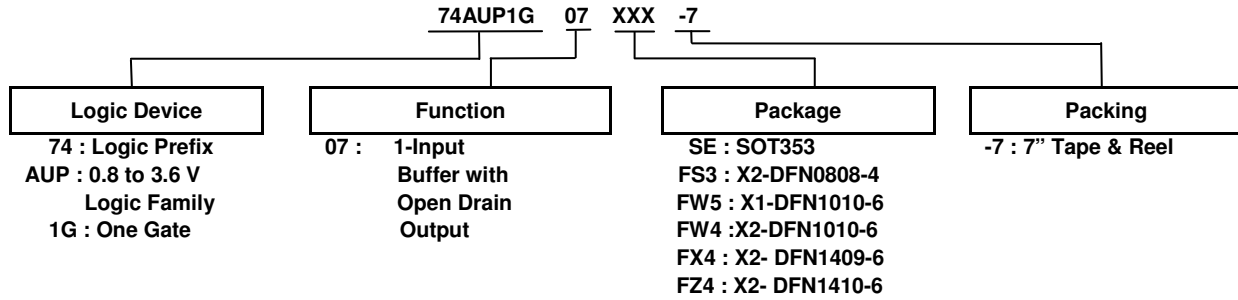

Device	Package Code	Package (Notes 4 & 5)	Package Size	7" Tape and Reel	
				Quantity	Part Number Suffix
74AUP1G07SE-7	SE	SOT353	2.0mm x 2.0mm x 1.1mm 0.65 mm lead pitch	3,000/Tape & Reel	-7
74AUP1G07FS3-7	FS3	X2-DFN0808-4	0.8mm x 0.8 mm x 0.35mm 0.5 mm pad pitch (diamond)	5,000/Tape & Reel	-7
74AUP1G07FW5-7	FW5	X1-DFN1010-6	1.0mm x 1.0mm x 0.5mm 0.35 mm pad pitch	5,000/Tape & Reel	-7
74AUP1G07FW4-7	FW4	X2-DFN1010-6	1.0mm x 1.0mm x 0.4mm 0.35 mm pad pitch	5,000/Tape & Reel	-7
74AUP1G07FX4-7	FX4	X2-DFN1409-6 Chip Scale Alternative	1.4mm x 0.9mm x 0.4mm 0.5 mm pad pitch	5,000/Tape & Reel	-7
74AUP1G07FZ4-7	FZ4	X2-DFN1410-6	1.4mm x 1.0mm x 0.4mm 0.5 mm pad pitch	5,000/Tape & Reel	-7

Notes: 4. Pad layout as shown on Diodes Inc. suggested pad layout document AP02001, which can be found on our website at <http://www.diodes.com/datasheets/ap02001.pdf>.
 5. The taping orientation is located on our website at <http://www.diodes.com/datasheets/ap02007.pdf>.

Pin Descriptions

Pin Name	Function
NC	No Connection
A	Data Input
GND	Ground
Y	Data Output
V _{CC}	Supply Voltage

Logic Diagram

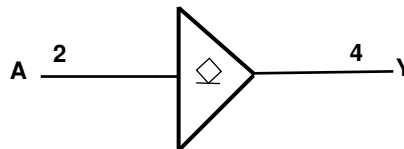

Function Table

Inputs	Output
A	Y
H	Z
L	L

Absolute Maximum Ratings (Notes 6 & 7) (@ $T_A = +25^\circ\text{C}$, unless otherwise specified.)

Symbol	Parameter	Rating	Unit
ESD HBM	Human Body Model ESD Protection	2	kV
ESD CDM	Charged Device Model ESD Protection	1	kV
V_{CC}	Supply Voltage Range	-0.5 to +4.6	V
V_I	Input Voltage Range	-0.5 to +4.6	V
V_O	Voltage Applied to Output in High or Low State	-0.5 to +4.6	V
I_{IK}	Input Clamp Current $V_I < 0$	50	mA
I_{OK}	Output Clamp Current ($V_O < 0$)	50	mA
I_O	Continuous Output Current ($V_O = 0$ to V_{CC})	± 20	mA
I_{CC}	Continuous Current through V_{CC}	50	mA
I_{GND}	Continuous Current through GND	-50	mA
T_J	Operating Junction Temperature	-40 to +150	$^\circ\text{C}$
T_{STG}	Storage Temperature	-65 to +150	$^\circ\text{C}$

- Notes:
- Stresses beyond the absolute maximum may result in immediate failure or reduced reliability. These are stress values and device operation should be within recommend values.
 - Forcing the maximum allowed voltage could cause a condition exceeding the maximum current or conversely forcing the maximum current could cause a condition exceeding the maximum voltage. The ratings of both current and voltage must be maintained within the controlled range.

Recommended Operating Conditions (Note 8) (@ $T_A = +25^\circ\text{C}$, unless otherwise specified.)

Symbol	Parameter	Min	Max	Unit	
V_{CC}	Operating Voltage	0.8	3.6	V	
V_I	Input Voltage	0	3.6	V	
V_O	Output Voltage	0	3.6	V	
I_{OL}	Low-Level Output Current	$V_{CC} = 0.8\text{V}$	—	20	μA
		$V_{CC} = 1.1\text{V}$	—	1.1	mA
		$V_{CC} = 1.4\text{V}$	—	1.7	
		$V_{CC} = 1.65\text{V}$	—	1.9	
		$V_{CC} = 2.3\text{V}$	—	3.1	
		$V_{CC} = 3.0\text{V}$	—	4	
$\Delta t/\Delta V$	Input Transition Rise or Fall Rate	$V_{CC} = 0.8\text{V}$ to 3.6V	—	200	ns/V
T_A	Operating Free-Air Temperature	-40	+125	$^\circ\text{C}$	

- Note: 8. Unused inputs should be held at V_{CC} or Ground.

Electrical Characteristics (@T_A = +25°C, unless otherwise specified.)

Symbol	Parameter	Test Conditions	V _{CC}	T _A = +25°C		T _A = -40°C to +85°C		Unit
				Min	Max	Min	Max	
V _{IH}	High-Level Input Voltage	—	0.8V to 1.65V	0.80 x V _{CC}	—	0.80 x V _{CC}	—	V
		—	1.65V to 1.95V	0.65 x V _{CC}	—	0.65 x V _{CC}	—	
		—	2.3V to 2.7V	1.6	—	1.6	—	
		—	3.0V to 3.6V	2.0	—	2.0	—	
V _{IL}	Low-Level Input Voltage	—	0.8V to 1.65V	—	0.30 x V _{CC}	—	0.30 x V _{CC}	V
		—	1.65V to 1.95V	—	0.35 x V _{CC}	—	0.35 x V _{CC}	
		—	2.3V to 2.7V	—	0.7	—	0.7	
		—	3.0V to 3.6V	—	0.9	—	0.9	
V _{OL}	Low-Level Output Voltage	I _{OL} = 20μA	0.8V to 3.6V	—	0.1	—	0.1	V
		I _{OL} = 1.1mA	1.1V	—	0.3 x V _{CC}	—	0.3 x V _{CC}	
		I _{OL} = 1.7mA	1.4V	—	0.31	—	0.37	
		I _{OL} = 1.9mA	1.65V	—	0.31	—	0.35	
		I _{OL} = 2.3mA	2.3V	—	0.31	—	0.33	
		I _{OL} = 3.1mA		—	0.44	—	0.45	
		I _{OL} = 2.7mA	3V	—	0.31	—	0.33	
		I _{OL} = 4mA		—	0.44	—	0.45	
I _I	Input Current	A or B Input V _I = GND to 3.6V	0V to 3.6V	—	± 0.1	—	± 0.5	μA
I _{OFF}	Power Down Leakage Current	V _I or V _O = 0V to 3.6V	0	—	± 0.2	—	± 0.5	μA
I _{OZ}	Z State Leakage Current	V _O = 3.6V V _I = 3.6V	3.6V	—	± 0.2	—	± 0.5	μA
ΔI _{OFF}	Delta Power Down Leakage Current	V _I or V _O = 0V to 3.6V	0V to 0.2V	—	0.2	—	0.6	μA
I _{CC}	Supply Current	V _I = GND or V _{CC} , I _O =0	0.8V to 3.6V	—	0.5	—	0.9	μA
ΔI _{CC}	Additional Supply Current	Input at V _{CC} -0.6V	3.3V	—	40	—	50	μA

Electrical Characteristics (continued) (@ $T_A = +25^\circ\text{C}$, unless otherwise specified.)

Symbol	Parameter	Test Conditions	V_{CC}	$T_A = -40^\circ\text{C to } +125^\circ\text{C}$		Unit
				Min	Max	
V_{IH}	High-Level Input Voltage	—	0.8V to 1.65V	$0.80 \times V_{CC}$	—	V
		—	1.65V to 1.95V	$0.70 \times V_{CC}$	—	
		—	2.3V to 2.7V	1.6	—	
		—	3.0V to 3.6V	2.0	—	
V_{IL}	Low-Level Input Voltage	—	0.8V to 1.65V	—	$0.25 \times V_{CC}$	V
		—	1.65V to 1.95V	—	$0.35 \times V_{CC}$	
		—	2.3V to 2.7V	—	0.7	
		—	3.0V to 3.6V	—	0.9	
V_{OL}	Low-Level Output Voltage	$I_{OL} = 20\mu\text{A}$	0.8V to 3.6V	—	0.11	V
		$I_{OL} = 1.1\text{mA}$	1.1V	—	$0.3 \times V_{CC}$	
		$I_{OL} = 1.7\text{mA}$	1.4V	—	0.41	
		$I_{OL} = 1.9\text{mA}$	1.65V	—	0.39	
		$I_{OL} = 2.3\text{mA}$	2.3V	—	0.36	
		$I_{OL} = 3.1\text{mA}$		—	0.50	
		$I_{OL} = 2.7\text{mA}$	3V	—	0.36	
		$I_{OL} = 4\text{mA}$		—	0.50	
I_I	Input Current	A or B Input $V_I = \text{GND to } 3.6\text{V}$	0V to 3.6V	—	± 0.75	μA
I_{OFF}	Power Down Leakage Current	V_I or $V_O = 0\text{V to } 3.6\text{V}$	0	—	± 3.5	μA
I_{OZ}	Z State Leakage Current	$V_O = 3.6\text{V}$ $V_I = 3.6\text{V}$	3.6V	—	± 1.5	μA
ΔI_{OFF}	Delta Power Down Leakage Current	V_I or $V_O = 0\text{V to } 3.6\text{V}$	0V to 0.2V	—	± 2.5	μA
I_{CC}	Supply Current	$V_I = \text{GND or } V_{CC}, I_O = 0$	0.8V to 3.6V	—	3.0	μA
ΔI_{CC}	Additional Supply Current	Input at $V_{CC} - 0.6\text{V}$	3.3V	—	75	μA

Switching Characteristics

 $C_L = 5\text{pF}$, See Figure 1

Parameter	From Input	TO OUTPUT	V _{cc}	T _A = +25°C			T _A = -40°C to +85°C		T _A = -40°C to +125°C		Unit
				Min	Typ	Max	Min	Max	Min	Max	
t _{pd}	A	Y	0.8V	—	11.6	—	—	—	—	—	ns
			1.2V ± 0.1V	2.0	4.1	7.5	2.0	9.1	2.0	10.0	
			1.5V ± 0.1V	1.5	3.0	5.1	1.5	6.1	1.5	6.7	
			1.8V ± 0.15V	1.2	2.7	4.0	1.2	5.0	1.2	5.5	
			2.5V ± 0.2V	1.0	2.3	3.2	1.0	4.0	1.0	4.4	
			3.3V ± 0.3V	0.8	2.2	2.8	0.8	3.3	0.8	3.6	

 $C_L = 10\text{pF}$, See Figure 1

Parameter	From Input	TO OUTPUT	V _{cc}	T _A = +25°C			T _A = -40°C to +85°C		T _A = -40°C to +125°C		Unit
				Min	Typ	Max	Min	Max	Min	Max	
t _{pd}	A	Y	0.8V	—	14.7	—	—	—	—	—	ns
			1.2V ± 0.1V	2.5	5.1	9.0	2.5	11.2	2.5	12.3	
			1.5V ± 0.1V	2.0	3.8	6.1	2.0	7.4	2.0	8.1	
			1.8V ± 0.15V	1.7	3.6	4.8	1.7	6.1	1.7	6.7	
			2.5V ± 0.2V	1.4	3.3	4.5	1.4	4.8	1.4	5.3	
			3.3V ± 0.3V	1.2	3.1	4.2	1.2	4.5	1.2	5.0	

 $C_L = 15\text{pF}$, See Figure 1

Parameter	From Input	TO OUTPUT	V _{cc}	T _A = +25°C			T _A = -40°C to +85°C		T _A = -40°C to +125°C		Unit
				Min	Typ	Max	Min	Max	Min	Max	
t _{pd}	A	Y	0.8V	—	17.7	—	—	—	—	—	ns
			1.2V ± 0.1V	2.9	6.1	10.4	2.9	13.1	2.9	14.5	
			1.5V ± 0.1V	2.3	4.5	6.8	2.3	8.6	2.3	9.4	
			1.8V ± 0.15V	2.1	4.4	6.7	2.1	7.8	2.1	8.6	
			2.5V ± 0.2V	1.7	4.2	5.9	1.7	6.8	1.7	6.9	
			3.3V ± 0.3V	1.5	4.0	5.7	1.5	6.1	1.5	6.7	

 $C_L = 30\text{pF}$, See Figure 1

Parameter	From Input	TO OUTPUT	V _{cc}	T _A = +25°C			T _A = -40°C to +85°C		T _A = -40°C to +125°C		Unit
				Min	Typ	Max	Min	Max	Min	Max	
t _{pd}	A	Y	0.8V	—	24.6	—	—	—	—	—	ns
			1.2V ± 0.1V	3.9	9.0	15.6	3.9	18.8	3.9	20.7	
			1.5V ± 0.1V	3.2	7.5	13.4	3.2	13.7	3.2	13.7	
			1.8V ± 0.15V	2.9	6.8	12.4	2.9	12.6	2.9	12.6	
			2.5V ± 0.2V	2.5	6.5	10.7	2.5	10.9	2.5	12.1	
			3.3V ± 0.3V	2.3	6.4	9.7	2.3	10.4	2.3	11.4	

Operating and Package Characteristics (@T_A = +25 °C, unless otherwise specified.)

Parameter		Test Conditions		V _{CC}	Typ	Unit
C _{pd}	Power Dissipation Capacitance	f = 1MHz No Load		0.8V	2.6	pF
				1.2V ± 0.1V	2.8	
				1.5V ± 0.1V	2.9	
				1.8V ± 0.15V	3.1	
				2.5V ± 0.2V	3.6	
				3.3V ± 0.3V	4.2	
C _i	Input Capacitance	V _i = V _{CC} or GND		0V or 3.3V	1.5	pF
θ _{JA}	Thermal Resistance Junction-to-Ambient	SOT353	(Note 9)	—	371	°C/W
		X2-DFN0808-4		—	430	
		X1-DFN1010-6		—	435	
		X2-DFN1010-6		—	445	
		X2-DFN1409-6		—	470	
		X2-DFN1410-6		—	460	
θ _{JC}	Thermal Resistance Junction-to-Case	SOT353	(Note 9)	—	143	°C/W
		X2-DFN0808-4		—	240	
		X1-DFN1010-6		—	250	
		X2-DFN1010-6		—	250	
		X2-DFN1409-6		—	275	
		X2-DFN1410-6		—	265	

Note: 9. Test condition for each of the six package types: Device mounted on FR-4 substrate PC board, 2oz copper, with minimum recommended pad layout.

Parameter Measurement Information

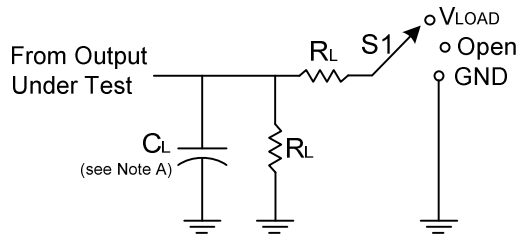

TEST	S1	RL
t_{PLZ}/t_{PZL}	Vload	5kΩ

V _{CC}	Inputs		V _M	V _{LOAD}	C _L	V _Δ
	V _I	t _r /t _f				
0.8V	V _{CC}	≤3ns	V _{CC} /2	2 X V _{CC}	5, 10, 15, 30pF	0.1V
1.2V±0.1V	V _{CC}	≤3ns	V _{CC} /2	2 X V _{CC}	5, 10, 15, 30pF	0.1V
1.5V±0.1V	V _{CC}	≤3ns	V _{CC} /2	2 X V _{CC}	5, 10, 15, 30pF	0.1V
1.8V±0.15V	V _{CC}	≤3ns	V _{CC} /2	2 X V _{CC}	5, 10, 15, 30pF	0.15V
2.5V±0.2V	V _{CC}	≤3ns	V _{CC} /2	2 X V _{CC}	5, 10, 15, 30pF	0.15V
3.3V±0.3V	V _{CC}	≤3ns	V _{CC} /2	2 X V _{CC}	5, 10, 15, 30pF	0.3V

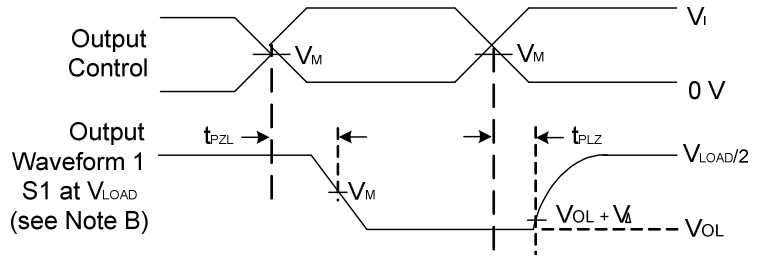
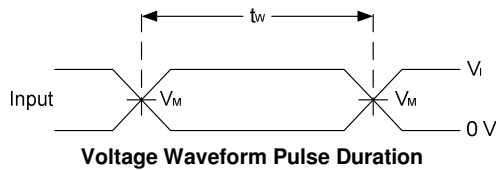

Figure 1 Load Circuit and Voltage Waveforms

- Notes:
- A. Includes test lead and test apparatus capacitance.
 - B. All pulses are supplied at pulse repetition rate ≤ 10 MHz.
 - C. Inputs are measured separately one transition per measurement.
 - D. For the open drain device the specified propagation delay t_{PD} is the same as t_{PLZ} and t_{PZL} .

Marking Information

(1) SOT353

(Top View)

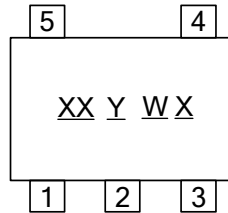

XX : Identification code
Y : Year 0~9
W : Week : A~Z : 1~26 week;
a~z : 27~52 week; z represents
52 and 53 week
X : A~Z : Internal code

Part Number	Package	Identification Code
74AUP1G07SE-7	SOT353	XN

(2) X2-DFN0808-4, X1-DFN1010-6, X2-DFN1010-6, X2-DFN1409-6 and X2-DFN1410-6

(Top View)

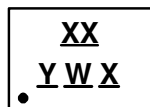

XX : Identification Code
Y : Year : 0~9
W : Week : A~Z : 1~26 week;
a~z : 27~52 week; z represents
52 and 53 week
X : A~Z : Internal code

Part Number	Package	Identification Code
74AUP1G07FS3-7	X2-DFN0808-4	YN
74AUP1G07FW5-7	X1-DFN1010-6	Q6
74AUP1G07FW4-7	X2-DFN1010-6	XN
74AUP1G07FX4-7	X2-DFN1409-6	HE
74AUP1G07FZ4-7	X2-DFN1410-6	XN

SOT353 Package Outline Dimensions and Suggested Pad Layout

Please see AP02002 at <http://www.diodes.com/datasheets/ap02002.pdf> for the latest version.

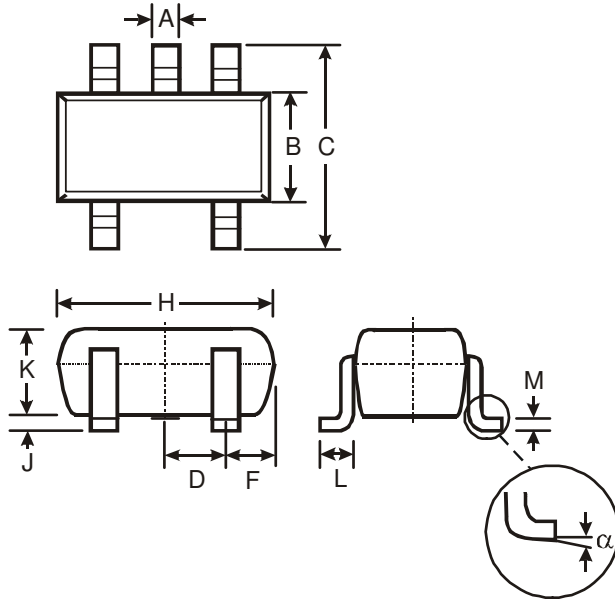

SOT353			
Dim	Min	Max	Typ
A	0.10	0.30	0.25
B	1.15	1.35	1.30
C	2.00	2.20	2.10
D	0.65 Typ		
F	0.40	0.45	0.425
H	1.80	2.20	2.15
J	0	0.10	0.05
K	0.90	1.00	1.00
L	0.25	0.40	0.30
M	0.10	0.22	0.11
α	0°	8°	-

All Dimensions in mm

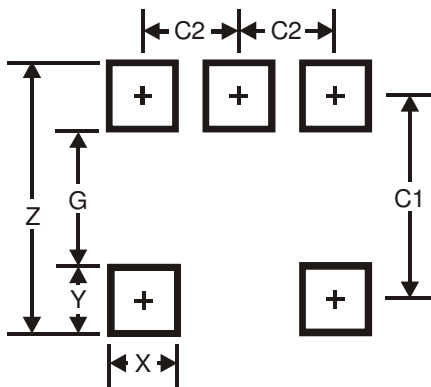

Dimensions	Value (in mm)
Z	2.5
G	1.3
X	0.42
Y	0.6
C1	1.9
C2	0.65

X1-DFN1010-6 (Type B) Package Outline Dimensions and Suggested Pad Layout

Please see AP02002 at <http://www.diodes.com/datasheets/ap02002.pdf> for the latest version.

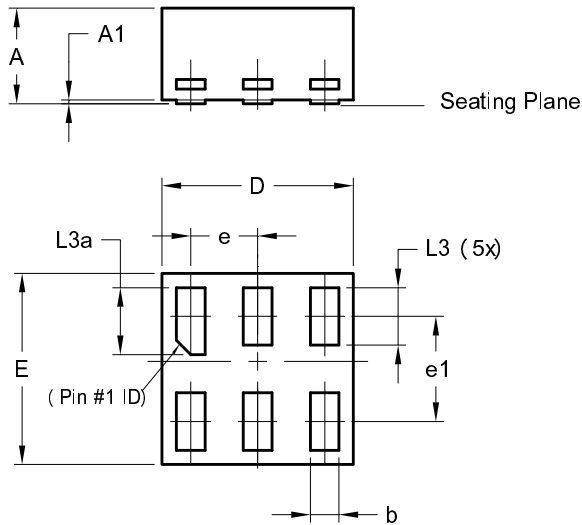

X1-DFN1010-6 (Type B)			
Dim	Min	Max	Typ
A	-	0.50	0.39
A1	-	0.04	-
b	0.12	0.20	0.15
D	0.95	1.050	1.00
E	0.95	1.050	1.00
e	0.35 BSC		
e1	0.55 BSC		
L3	0.27	0.30	0.30
L3a	0.32	0.40	0.35
All Dimensions in mm			

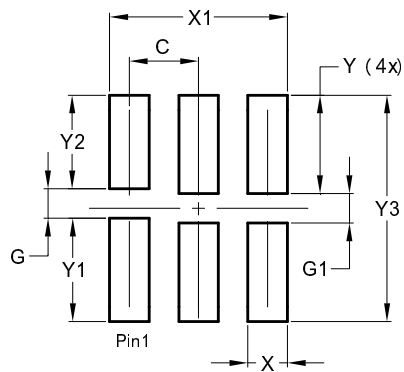

Dimensions	Value (in mm)
C	0.350
G	0.150
G1	0.150
X	0.200
X1	0.900
Y	0.500
Y1	0.525
Y2	0.475
Y3	1.150

X2-DFN1010-6 Package Outline Dimensions and Suggested Pad Layout

Please see AP02002 at <http://www.diodes.com/datasheets/ap02002.pdf> for the latest version.

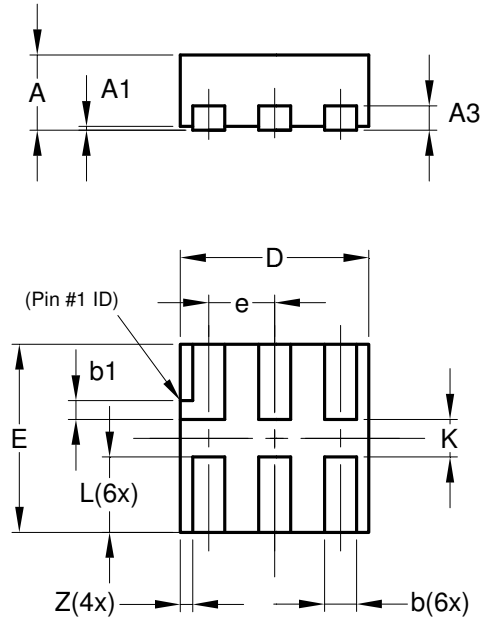

X2-DFN1010-6			
Dim	Min	Max	Typ
A	—	0.40	0.39
A1	0.00	0.05	0.02
A3	—	—	0.13
b	0.14	0.20	0.17
b1	0.05	0.15	0.10
D	0.95	1.05	1.00
E	0.95	1.05	1.00
e	—	—	0.35
L	0.35	0.45	0.40
K	0.15	—	—
Z	—	—	0.065
All Dimensions in mm			

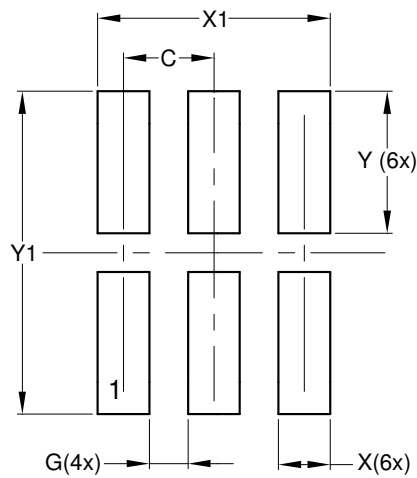

Dimensions	Value (in mm)
C	0.350
G	0.150
X	0.200
X1	0.900
Y	0.550
Y1	1.250

X2-DFN1409-6 Package Outline Dimensions and Suggested Pad Layout

Please see AP02002 at <http://www.diodes.com/datasheets/ap02002.pdf> for the latest version.

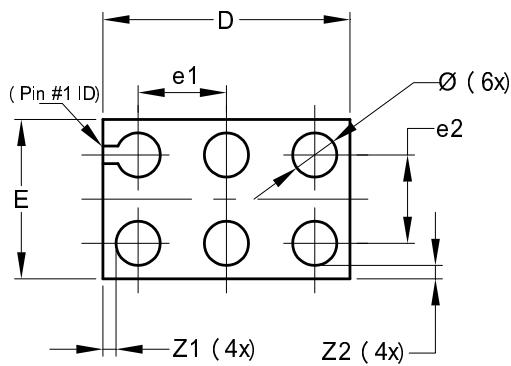
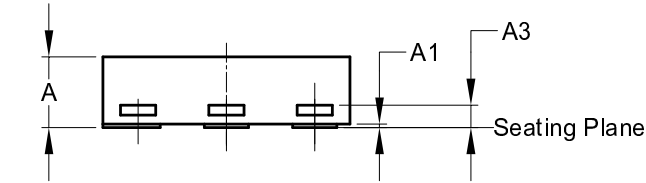

X2-DFN1409-6			
Dim	Min	Max	Typ
A	-	0.40	0.39
A1	0	0.05	0.02
A3	-	-	0.13
Ø	0.20	0.30	0.25
D	1.35	1.45	1.40
E	0.85	0.95	0.90
e1	-	-	0.50
e2	-	-	0.50
Z1	-	-	0.075
Z2	-	-	0.075
All Dimensions in mm			

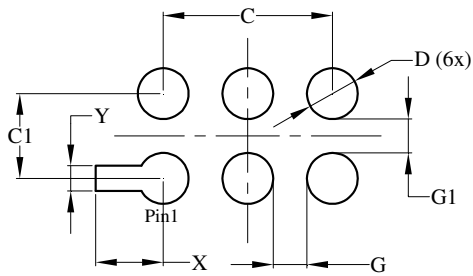

Dimensions	Value (in mm)
C	1.000
C1	0.500
D	0.300
G	0.200
G1	0.200
X	0.400
Y	0.150

X2-DFN1410-6 Package Outline Dimensions and Suggested Pad Layout

Please see AP02002 at <http://www.diodes.com/datasheets/ap02002.pdf> for the latest version.

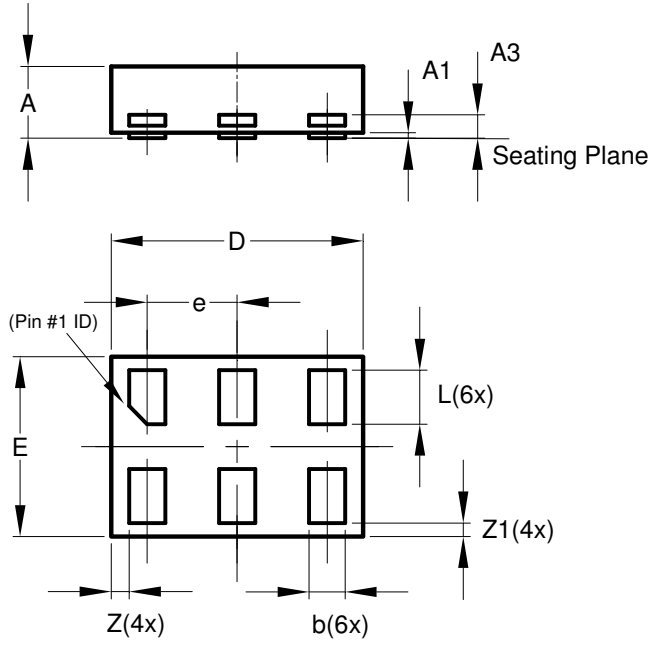

X2-DFN1410-6			
Dim	Min	Max	Typ
A	—	0.40	0.39
A1	0.00	0.05	0.02
A3	—	—	0.13
b	0.15	0.25	0.20
D	1.35	1.45	1.40
E	0.95	1.05	1.00
e	—	—	0.50
L	0.25	0.35	0.30
Z	—	—	0.10
Z1	0.045	0.105	0.075
All Dimensions in mm			

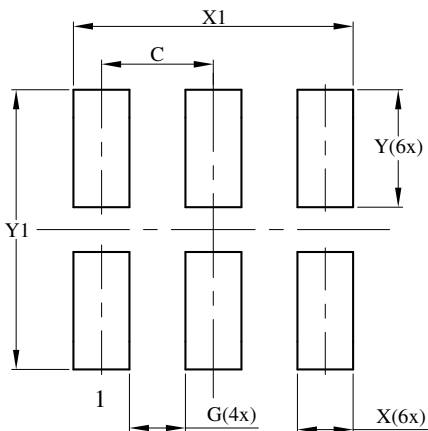

Dimensions	Value (in mm)
C	0.500
G	0.250
X	0.250
X1	1.250
Y	0.525
Y1	1.250

IMPORTANT NOTICE

DIODES INCORPORATED MAKES NO WARRANTY OF ANY KIND, EXPRESS OR IMPLIED, WITH REGARDS TO THIS DOCUMENT, INCLUDING, BUT NOT LIMITED TO, THE IMPLIED WARRANTIES OF MERCHANTABILITY AND FITNESS FOR A PARTICULAR PURPOSE (AND THEIR EQUIVALENTS UNDER THE LAWS OF ANY JURISDICTION).

Diodes Incorporated and its subsidiaries reserve the right to make modifications, enhancements, improvements, corrections or other changes without further notice to this document and any product described herein. Diodes Incorporated does not assume any liability arising out of the application or use of this document or any product described herein; neither does Diodes Incorporated convey any license under its patent or trademark rights, nor the rights of others. Any Customer or user of this document or products described herein in such applications shall assume all risks of such use and will agree to hold Diodes Incorporated and all the companies whose products are represented on Diodes Incorporated website, harmless against all damages.

Diodes Incorporated does not warrant or accept any liability whatsoever in respect of any products purchased through unauthorized sales channel.

Should Customers purchase or use Diodes Incorporated products for any unintended or unauthorized application, Customers shall indemnify and hold Diodes Incorporated and its representatives harmless against all claims, damages, expenses, and attorney fees arising out of, directly or indirectly, any claim of personal injury or death associated with such unintended or unauthorized application.

Products described herein may be covered by one or more United States, international or foreign patents pending. Product names and markings noted herein may also be covered by one or more United States, international or foreign trademarks.

This document is written in English but may be translated into multiple languages for reference. Only the English version of this document is the final and determinative format released by Diodes Incorporated.

LIFE SUPPORT

Diodes Incorporated products are specifically not authorized for use as critical components in life support devices or systems without the express written approval of the Chief Executive Officer of Diodes Incorporated. As used herein:

A. Life support devices or systems are devices or systems which:

1. are intended to implant into the body, or
2. support or sustain life and whose failure to perform when properly used in accordance with instructions for use provided in the labeling can be reasonably expected to result in significant injury to the user.

B. A critical component is any component in a life support device or system whose failure to perform can be reasonably expected to cause the failure of the life support device or to affect its safety or effectiveness.

Customers represent that they have all necessary expertise in the safety and regulatory ramifications of their life support devices or systems, and acknowledge and agree that they are solely responsible for all legal, regulatory and safety-related requirements concerning their products and any use of Diodes Incorporated products in such safety-critical, life support devices or systems, notwithstanding any devices- or systems-related information or support that may be provided by Diodes Incorporated. Further, Customers must fully indemnify Diodes Incorporated and its representatives against any damages arising out of the use of Diodes Incorporated products in such safety-critical, life support devices or systems.

Copyright © 2015, Diodes Incorporated

www.diodes.com



Стандарт Электрон Связь

Мы молодая и активно развивающаяся компания в области поставок электронных компонентов. Мы поставляем электронные компоненты отечественного и импортного производства напрямую от производителей и с крупнейших складов мира.

Благодаря сотрудничеству с мировыми поставщиками мы осуществляем комплексные и плановые поставки широчайшего спектра электронных компонентов.

Собственная эффективная логистика и склад в обеспечивает надежную поставку продукции в точно указанные сроки по всей России.

Мы осуществляем техническую поддержку нашим клиентам и предпродажную проверку качества продукции. На все поставляемые продукты мы предоставляем гарантию .

Осуществляем поставки продукции под контролем ВП МО РФ на предприятия военно-промышленного комплекса России , а также работаем в рамках 275 ФЗ с открытием отдельных счетов в уполномоченном банке. Система менеджмента качества компании соответствует требованиям ГОСТ ISO 9001.

Минимальные сроки поставки, гибкие цены, неограниченный ассортимент и индивидуальный подход к клиентам являются основой для выстраивания долгосрочного и эффективного сотрудничества с предприятиями радиоэлектронной промышленности, предприятиями ВПК и научно-исследовательскими институтами России.

С нами вы становитесь еще успешнее!

Наши контакты:

Телефон: +7 812 627 14 35

Электронная почта: sales@st-electron.ru

Адрес: 198099, Санкт-Петербург,
Промышленная ул, дом № 19, литера Н,
помещение 100-Н Офис 331