

Features

- Epitaxial Planar Die Construction
- Complementary PNP Type Available (DCX53)
- Ideally Suited for Automated Assembly Processes
- Ideal for Medium Power Switching or Amplification Applications
- **Lead Free By Design/RoHS Compliant (Note 1)**
- **"Green" Device (Note 2)**

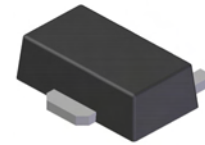

SOT89-3L

Mechanical Data

- Case: SOT89-3L
- Case Material: Molded Plastic, "Green" Molding Compound. UL Flammability Classification Rating 94V-0
- Moisture Sensitivity: Level 1 per J-STD-020C
- Terminals: Finish — Matte Tin annealed over Copper leadframe (Lead Free Plating). Solderable per MIL-STD-202, Method 208
- Marking & Type Code Information: See Page 3
- Ordering Information: See Page 3
- Weight: 0.072 grams (approximate)

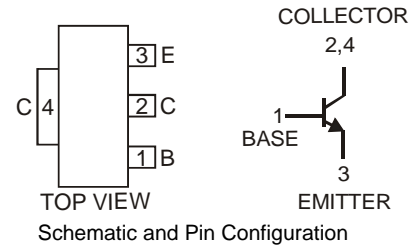

Maximum Ratings @T_A = 25°C unless otherwise specified

Characteristic	Symbol	Value	Unit
Collector-Base Voltage	V _{CB0}	100	V
Collector-Emitter Voltage	V _{CEO}	80	V
Emitter-Base Voltage	V _{EBO}	5	V
Collector Current	I _C	1	A
Peak Pulse Current	I _{CM}	1.5	A

Thermal Characteristics

Characteristic	Symbol	Value	Unit
Power Dissipation (Note 3) @ T _A = 25°C	P _D	1	W
Operating and Storage Temperature Range	T _j , T _{STG}	-55 to +150	°C
Thermal Resistance, Junction to Ambient Air (Note 3) @T _A = 25°C	R _{θJA}	125	°C/W

Electrical Characteristics @T_A = 25°C unless otherwise specified

Characteristic	Symbol	Min	Typ	Max	Unit	Test Conditions		
OFF CHARACTERISTICS (Note 4)								
Collector-Base Breakdown Voltage	V _{(BR)CBO}	100	—	—	V	I _C = 100μA, I _E = 0		
Collector-Emitter Breakdown Voltage	V _{(BR)CEO}	80	—	—	V	I _C = 10mA, I _B = 0		
Emitter-Base Breakdown Voltage	V _{(BR)EBO}	5.0	—	—	V	I _E = 10μA, I _C = 0		
Collector-Base Cutoff Current	I _{CBO}	—	—	0.1 20	μA	V _{CB} = 30V, I _E = 0 V _{CB} = 30V, I _E = 0, T _A = 150°C		
Emitter-Base Cutoff Current	I _{EBO}	—	—	100	nA	V _{EB} = 5.0V, I _C = 0		
ON CHARACTERISTICS (Note 4)								
DC Current Gain	h _{FE}	DCX56, DCX56-16		63 40	—	—	I _C = 5.0mA, V _{CE} = 2.0V I _C = 500mA, V _{CE} = 2.0V	
		DCX56		63	—	250	—	I _C = 150mA, V _{CE} = 2.0V
		DCX56-16		100	—	250	—	I _C = 150mA, V _{CE} = 2.0V
Collector-Emitter Saturation Voltage	V _{CE(SAT)}	—	—	0.5	V	I _C = 500mA, I _B = 50mA		
Base-Emitter Turn-On Voltage	V _{BE(ON)}	—	—	1.0	V	I _C = 500mA, V _{CE} = 2.0V		
SMALL SIGNAL CHARACTERISTICS								
Current Gain-Bandwidth Product	f _T	—	200	—	MHz	I _C = 50mA, V _{CE} = 5V, f = 100MHz		
Output Capacitance	C _{obo}	—	—	15	pF	V _{CB} = 10V, I _E = 0, f = 1MHz		

- Notes:
1. No purposefully added lead.
 2. Diodes Inc.'s "Green" policy can be found on our website at http://www.diodes.com/products/lead_free/index.php.
 3. Device mounted on FR-4 PCB; pad layout as shown on page 4 or in Diodes Inc. suggested pad layout document AP02001, which can be found on our website at <http://www.diodes.com/datasheets/ap02001.pdf>.
 4. Measured under pulsed conditions. Pulse width = 300μs. Duty cycle ≤2%.

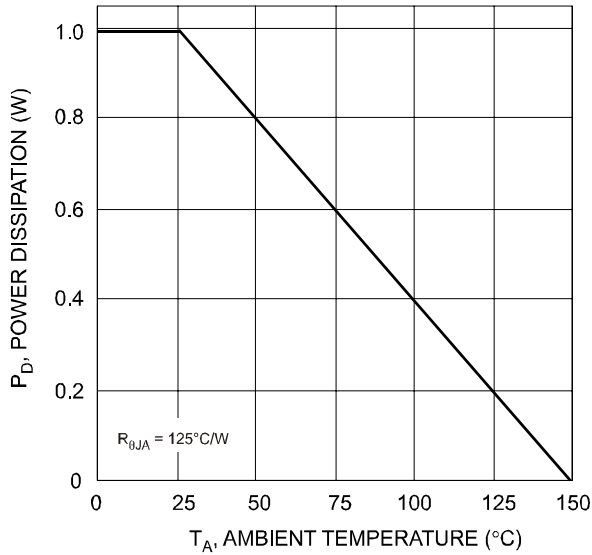

Fig. 1 Power Dissipation vs. Ambient Temperature

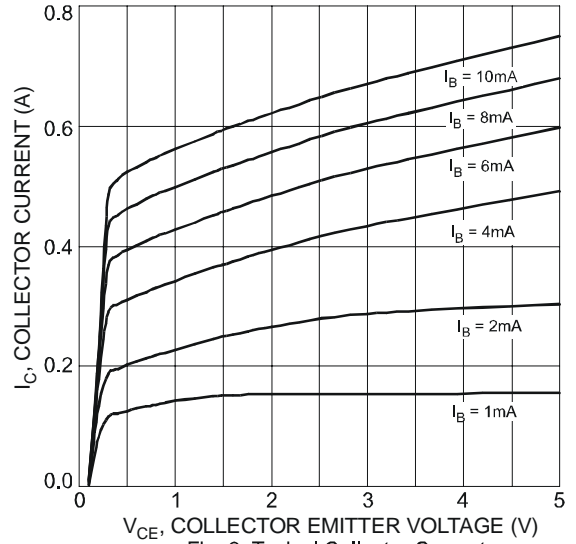

Fig. 2 Typical Collector Current vs. Collector Emitter Voltage

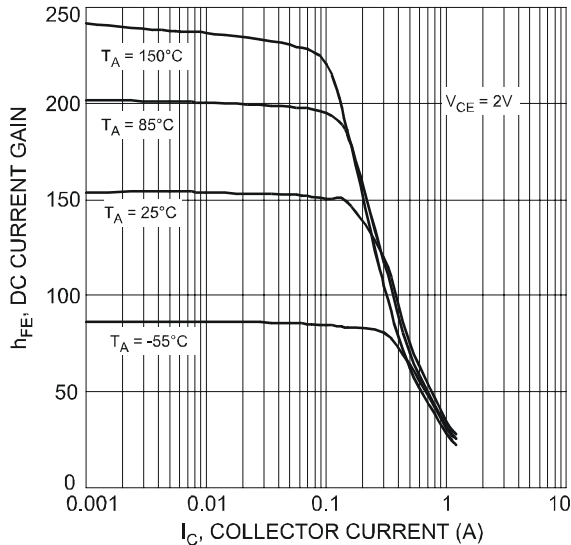

Fig. 3 Typical DC Current Gain vs. Collector Current

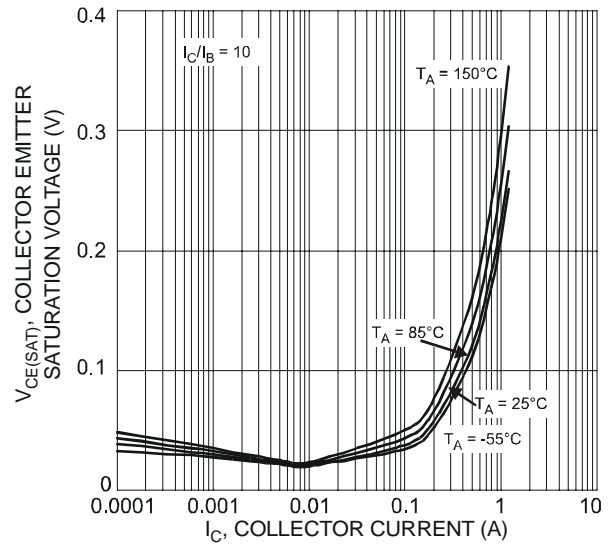

Fig. 4 Typical Collector Emitter Saturation Voltage vs. Collector Current

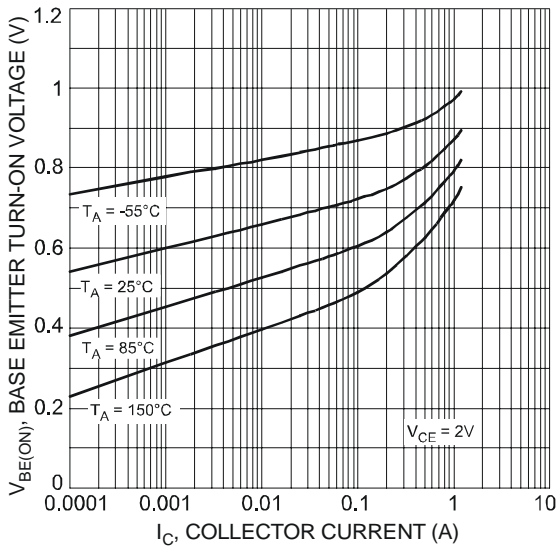

Fig. 5 Typical Base Emitter Turn-On Voltage vs. Collector Current

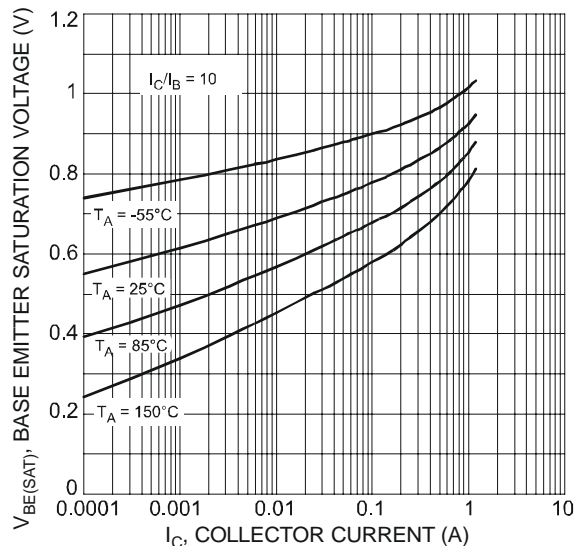

Fig. 6 Typical Base Emitter Saturation Voltage vs. Collector Current

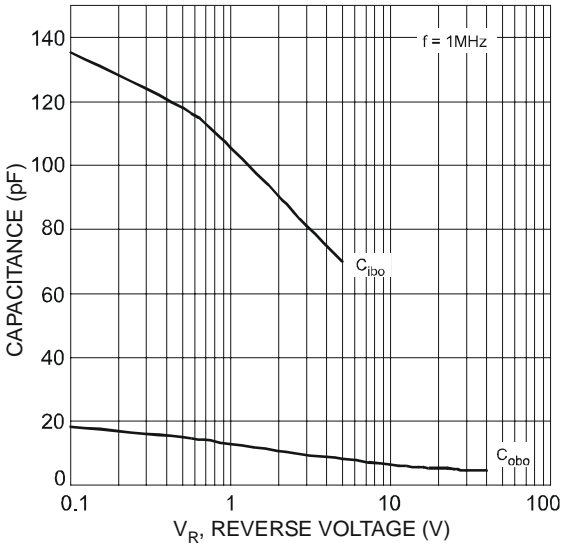

Fig. 7 Typical Capacitance Characteristics

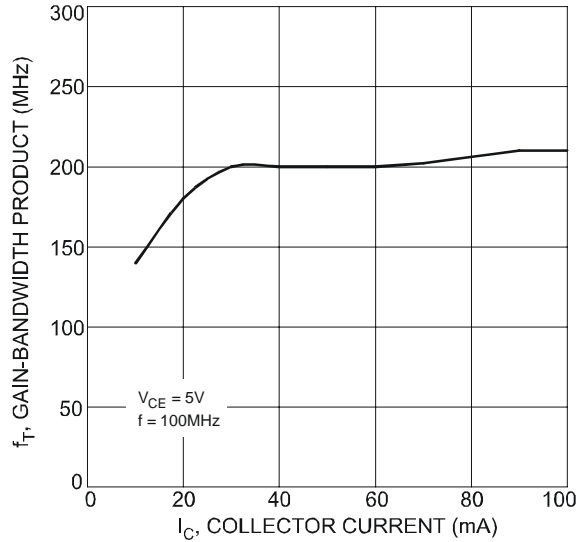

Fig. 8 Typical Gain-Bandwidth Product vs. Collector Current

Ordering Information (Note 5)

Device	Packaging	Shipping
DCX56-13	SOT89-3L	2500/Tape & Reel
DCX56-16-13	SOT89-3L	2500/Tape & Reel

Notes: 5. For packaging details, go to our website at <http://www.diodes.com/ap02007.pdf>.

Marking Information

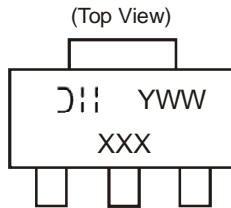

XXX = Product Type Marking Code ex. N18 = DCX56
 N18-16 = DCX56-16
 ☺ = Manufacturer's code marking
 YWW = Date Code Marking
 Y = Last digit of year ex: 7 = 2007
 WW = Week code 01 - 52

Package Outline Dimensions

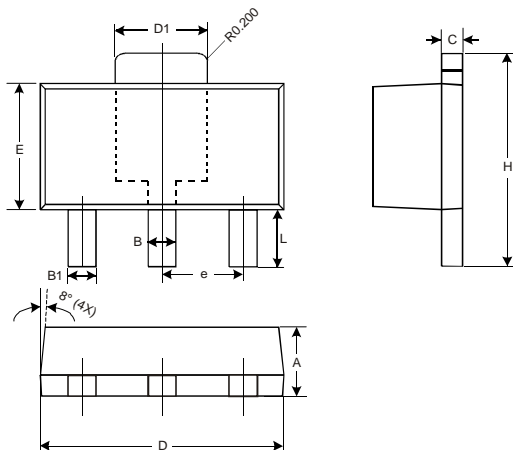

SOT89-3L			
Dim	Min	Max	Typ
A	1.40	1.60	1.50
B	0.45	0.55	0.50
B1	0.37	0.47	0.42
C	0.35	0.43	0.38
D	4.40	4.60	4.50
D1	1.50	1.70	1.60
E	2.40	2.60	2.50
e	—	—	1.50
H	3.95	4.25	4.10
L	0.90	1.20	1.05
All Dimensions in mm			

Suggested Pad Layout

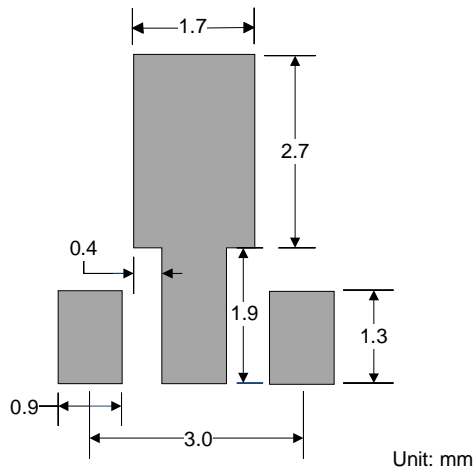

IMPORTANT NOTICE

Diodes Incorporated and its subsidiaries reserve the right to make modifications, enhancements, improvements, corrections or other changes without further notice to any product herein. Diodes Incorporated does not assume any liability arising out of the application or use of any product described herein; neither does it convey any license under its patent rights, nor the rights of others. The user of products in such applications shall assume all risks of such use and will agree to hold Diodes Incorporated and all the companies whose products are represented on our website, harmless against all damages.

LIFE SUPPORT

Diodes Incorporated products are not authorized for use as critical components in life support devices or systems without the expressed written approval of the President of Diodes Incorporated.



Стандарт Электрон Связь

Мы молодая и активно развивающаяся компания в области поставок электронных компонентов. Мы поставляем электронные компоненты отечественного и импортного производства напрямую от производителей и с крупнейших складов мира.

Благодаря сотрудничеству с мировыми поставщиками мы осуществляем комплексные и плановые поставки широчайшего спектра электронных компонентов.

Собственная эффективная логистика и склад в обеспечивает надежную поставку продукции в точно указанные сроки по всей России.

Мы осуществляем техническую поддержку нашим клиентам и предпродажную проверку качества продукции. На все поставляемые продукты мы предоставляем гарантию .

Осуществляем поставки продукции под контролем ВП МО РФ на предприятия военно-промышленного комплекса России , а также работаем в рамках 275 ФЗ с открытием отдельных счетов в уполномоченном банке. Система менеджмента качества компании соответствует требованиям ГОСТ ISO 9001.

Минимальные сроки поставки, гибкие цены, неограниченный ассортимент и индивидуальный подход к клиентам являются основой для выстраивания долгосрочного и эффективного сотрудничества с предприятиями радиоэлектронной промышленности, предприятиями ВПК и научно-исследовательскими институтами России.

С нами вы становитесь еще успешнее!

Наши контакты:

Телефон: +7 812 627 14 35

Электронная почта: sales@st-electron.ru

Адрес: 198099, Санкт-Петербург,
Промышленная ул, дом № 19, литера Н,
помещение 100-Н Офис 331