



Micro Commercial Components



Micro Commercial Components  
20736 Marilla Street Chatsworth  
CA 91311  
Phone: (818) 701-4933  
Fax: (818) 701-4939

## Features

- Halogen free available upon request by adding suffix "-HF"
- Lead Free Finish/RoHS Compliant ("P" Suffix designates RoHS Compliant. See ordering information)
- This device is designed for general purpose amplifier applications at collector current to 300mA
- Markin : MMBTA55=2H/B55, MMBTA56=2GM/B56
- Epoxy meets UL 94 V-0 flammability rating
- Moisture Sensitivity Level 1

## Maximum Ratings

Symbol	Rating	Rating	Unit
V <sub>CEO</sub>	Collector-Emitter Voltage	MMBTA55	60
		MMBTA56	80
V <sub>CBO</sub>	Collector-Base Voltage	MMBTA55	60
		MMBTA56	80
V <sub>EBO</sub>	Emitter-Base Voltage	4.0	V
I <sub>C</sub>	Collector Current, Continuous	500	mA
T <sub>J</sub>	Operating Junction Temperature	-55 to +150	°C
T <sub>STG</sub>	Storage Temperature	-55 to +150	°C

## Thermal Characteristics

Symbol	Rating	Max	Unit
P <sub>D</sub>	Total Device Dissipation* Derate above 25°C	225	mW
		1.8	mW/°C
R <sub>JA</sub>	Thermal Resistance, Junction to Ambient	556	°C/W

## Electrical Characteristics @ 25°C Unless Otherwise Specified

Symbol	Parameter	Min	Max	Units
--------	-----------	-----	-----	-------

### OFF CHARACTERISTICS

V <sub>(BR)CEO</sub>	Collector-Emitter Breakdown Voltage <sup>(1)</sup> (I <sub>C</sub> =1.0mA, I <sub>B</sub> =0)	MMBTA55	60	---	Vdc
		MMBTA56	80	---	
V <sub>(BR)EBO</sub>	Emitter-Base Breakdown Voltage (I <sub>E</sub> =100mA, I <sub>C</sub> =0)	---	4.0	---	Vdc
I <sub>CBO</sub>	Collector Cutoff Current (V <sub>CB</sub> =60Vdc, I <sub>E</sub> =0)	MMBTA55	---	0.1	uAdc
		MMBTA56	---	0.1	
I <sub>CES</sub>	Emitter Cutoff Current (V <sub>CE</sub> =60Vdc, I <sub>B</sub> =0)	---	0.1	---	uAdc

### ON CHARACTERISTICS

h <sub>FE</sub>	DC Current Gain (V <sub>CE</sub> =1.0Vdc, I <sub>C</sub> =10mA) (V <sub>CE</sub> =1.0Vdc, I <sub>C</sub> =100mA)	100	---	---
		100	---	---
V <sub>CE(sat)</sub>	Collector-Emitter Saturation Voltage (I <sub>C</sub> =100mA, I <sub>B</sub> =10mA)	---	0.25	Vdc
V <sub>BE(on)</sub>	Base-Emitter On Voltage (I <sub>C</sub> =100mA, V <sub>CE</sub> =1.0Vdc)	---	1.2	Vdc
f <sub>T</sub>	Current-Gain—Bandwidth Product <sup>(2)</sup> (I <sub>C</sub> =100mA, V <sub>CE</sub> =1.0Vdc, f=100MHz)	50	---	MHz

# MMBTA55 THRU MMBTA56

## PNP General Purpose Amplifier

### SOT-23

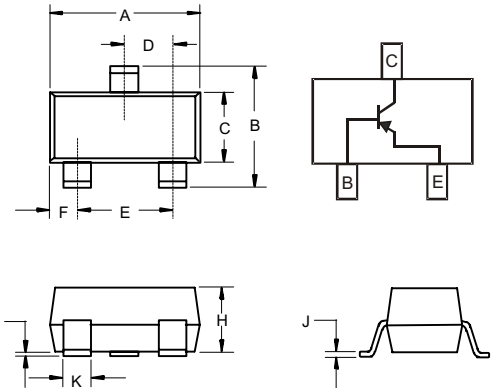

#### DIMENSIONS

DIM	INCHES		MM		NOTE
	MIN	MAX	MIN	MAX	
A	.110	.120	2.80	3.04	
B	.083	.104	2.10	2.64	
C	.047	.055	1.20	1.40	
D	.035	.041	.89	1.03	
E	.070	.081	1.78	2.05	
F	.018	.024	.45	.60	
G	.0005	.0039	.013	.100	
H	.035	.044	.89	1.12	
J	.003	.007	.085	.180	
K	.015	.020	.37	.51	

### Suggested Solder Pad Layout

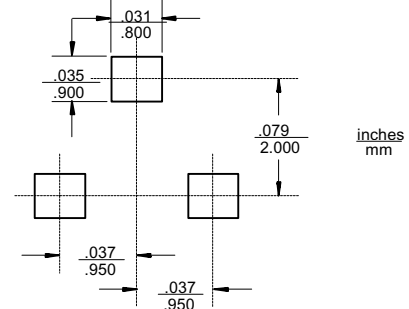

# MMBTA55 thru MMBTA56

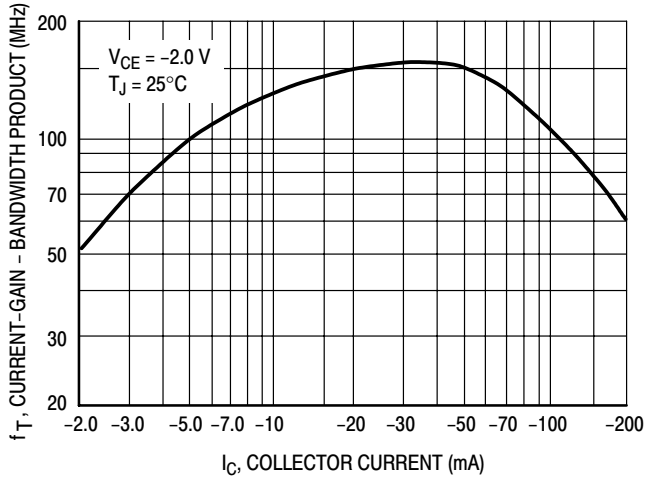

**Figure 2. Current-Gain — Bandwidth Product**

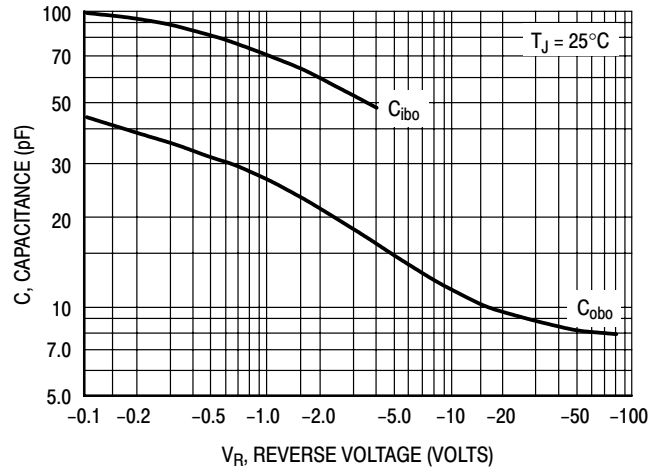

**Figure 3. Capacitance**

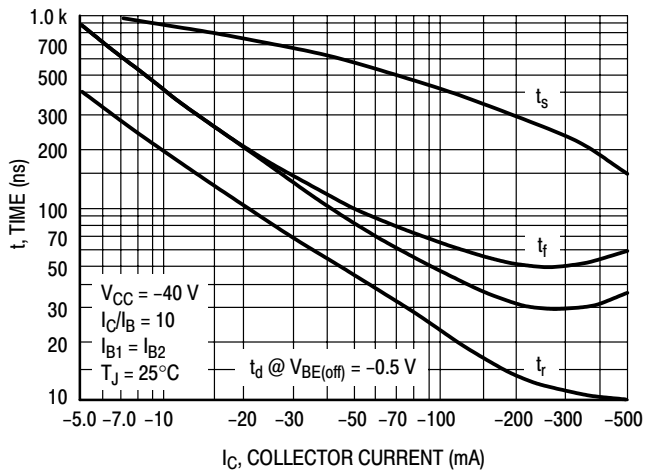

**Figure 4. Switching Time**

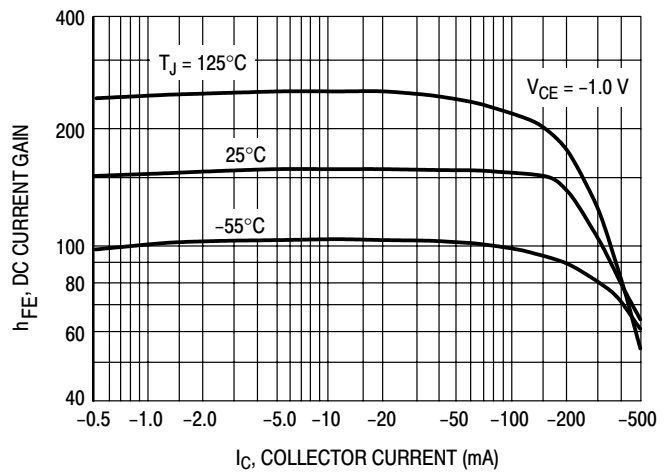

**Figure 5. DC Current Gain**

# MMBTA55 thru MMBTA56

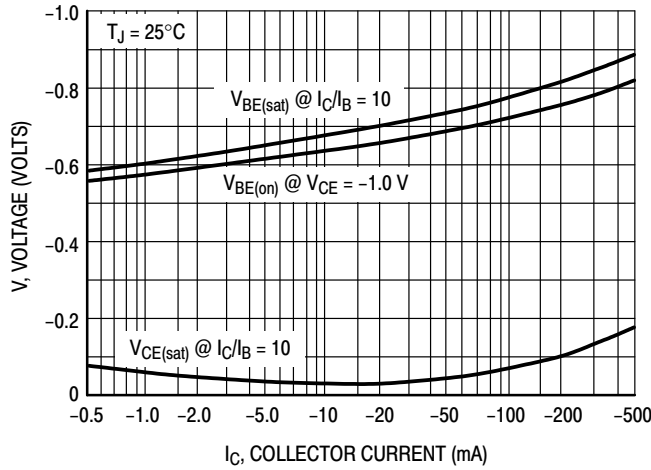

Figure 6. "ON" Voltages

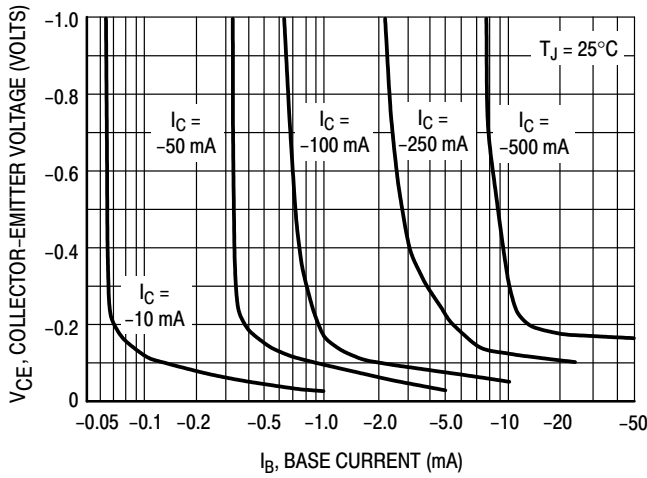

Figure 7. Collector Saturation Region

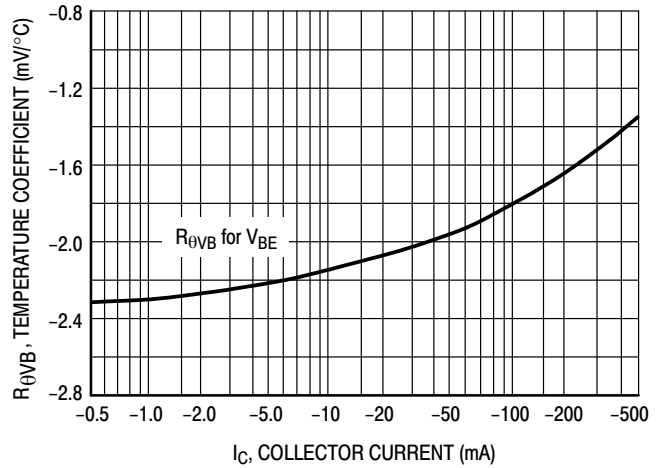

Figure 8. Base-Emitter Temperature Coefficient



Micro Commercial Components

### Ordering Information :

Device	Packing
Part Number-TP	Tape&Reel; 3Kpcs/Reel

Note : Adding "-HF" suffix for halogen free, eg. Part Number-TP-HF

#### \*\*\*IMPORTANT NOTICE\*\*\*

**Micro Commercial Components Corp.** reserves the right to make changes without further notice to any product herein to make corrections, modifications, enhancements, improvements, or other changes. **Micro Commercial Components Corp.** does not assume any liability arising out of the application or use of any product described herein; neither does it convey any license under its patent rights, nor the rights of others. The user of products in such applications shall assume all risks of such use and will agree to hold **Micro Commercial Components Corp.** and all the companies whose products are represented on our website, harmless against all damages.

#### \*\*\*LIFE SUPPORT\*\*\*

MCC's products are not authorized for use as critical components in life support devices or systems without the express written approval of Micro Commercial Components Corporation.

#### \*\*\*CUSTOMER AWARENESS\*\*\*

Counterfeiting of semiconductor parts is a growing problem in the industry. Micro Commercial Components (MCC) is taking strong measures to protect ourselves and our customers from the proliferation of counterfeit parts. MCC strongly encourages customers to purchase MCC parts either directly from MCC or from Authorized MCC Distributors who are listed by country on our web page cited below. Products customers buy either from MCC directly or from Authorized MCC Distributors are genuine parts, have full traceability, meet MCC's quality standards for handling and storage. **MCC will not provide any warranty coverage or other assistance for parts bought from Unauthorized Sources.** MCC is committed to combat this global problem and encourage our customers to do their part in stopping this practice by buying direct or from authorized distributors.

[www.mccsemi.com](http://www.mccsemi.com)



## Стандарт Электрон Связь

Мы молодая и активно развивающаяся компания в области поставок электронных компонентов. Мы поставляем электронные компоненты отечественного и импортного производства напрямую от производителей и с крупнейших складов мира.

Благодаря сотрудничеству с мировыми поставщиками мы осуществляем комплексные и плановые поставки широчайшего спектра электронных компонентов.

Собственная эффективная логистика и склад в обеспечивает надежную поставку продукции в точно указанные сроки по всей России.

Мы осуществляем техническую поддержку нашим клиентам и предпродажную проверку качества продукции. На все поставляемые продукты мы предоставляем гарантию .

Осуществляем поставки продукции под контролем ВП МО РФ на предприятия военно-промышленного комплекса России , а также работаем в рамках 275 ФЗ с открытием отдельных счетов в уполномоченном банке. Система менеджмента качества компании соответствует требованиям ГОСТ ISO 9001.

Минимальные сроки поставки, гибкие цены, неограниченный ассортимент и индивидуальный подход к клиентам являются основой для выстраивания долгосрочного и эффективного сотрудничества с предприятиями радиоэлектронной промышленности, предприятиями ВПК и научно-исследовательскими институтами России.

С нами вы становитесь еще успешнее!

### Наши контакты:

**Телефон:** +7 812 627 14 35

**Электронная почта:** [sales@st-electron.ru](mailto:sales@st-electron.ru)

**Адрес:** 198099, Санкт-Петербург,  
Промышленная ул, дом № 19, литера Н,  
помещение 100-Н Офис 331