

# Cree® PLCC2 1 in 1 SMD LED CLM1B-RKW/AKW



## PRODUCT DESCRIPTION

SMD LEDs is packaged in the industry standard package. These LEDs have high reliability performance and are designed to work under a wide range of environmental conditions.

This high reliability feature makes them ideally suited to be used under illumination application conditions.

Its wide viewing angle makes these LEDs ideally suited for channel letter, or general backlighting and illumination applications. The flat top emitting surface makes it easy for these LEDs to mate with light pipes.

## FEATURES

- Size (mm): 3.2 x 2.7
- Color and Typical Dominant Wavelength:  
Red (624nm)  
Amber (591nm)
- Luminous Intensity (mcd)  
CLM1B-RKW:  
(450 - 1120)  
CLM1B-AKW:  
(450 - 1120)
- Viewing angle: 120 degree
- Lead-Free
- RoHS Compliant

## APPLICATIONS

- Light Strip
- Channel Letter
- Architectural Lighting

### ABSOLUTE MAXIMUM RATINGS ( $T_A = 25^\circ\text{C}$ )

Items	Symbol	Absolute Maximum Rating	Unit
		RKW/AKW	
Forward Current	$I_F$	50	mA
Peak Forward Current <sup>Note</sup>	$I_{FP}$	200	mA
Reverse Voltage	$V_R$	5	V
Power Dissipation	$P_D$	130	mW
Operation Temperature	$T_{opr}$	-40 ~ +100	$^\circ\text{C}$
Storage Temperature	$T_{stg}$	-40 ~ +100	$^\circ\text{C}$
Junction Temperature	$T_J$	110	$^\circ\text{C}$
Junction/Ambient	$R_{THJA}$	450	$^\circ\text{C}/\text{W}$
Junction/Solder Point	$R_{THJS}$	300	$^\circ\text{C}/\text{W}$
Electrostatic Discharge Classification(MIL-STD-883E)	ESD	Class 2	

**Note:** Pulse width  $\leq 0.1$  msec, duty  $\leq 1/10$ .

### TYPICAL ELECTRICAL & OPTICAL CHARACTERISTICS ( $T_A = 25^\circ\text{C}$ )

Characteristics	Color	Symbol	Condition	Unit	Minimum	Typical	Maximum
Forward Voltage	RKW/AKW	$V_F$	$I_F = 20$ mA	V		2.1	2.6
Reverse Current	RKW/AKW	$I_R$	$V_R = 5$ V	$\mu\text{A}$			10
Dominant Wavelength	RKW	$\lambda_D$	$I_F = 20$ mA	nm	618	624	630
	AKW	$\lambda_D$	$I_F = 20$ mA	nm	584	591	596
Luminous Intensity	RKW	$I_V$	$I_F = 20$ mA	mcd	450	650	
	AKW	$I_V$	$I_F = 20$ mA	mcd	450	750	
50% Power Angle	RKW/AKW	$2\theta_{1/2}$	$I_F = 20$ mA	deg		120	

### INTENSITY BIN LIMIT ( $I_F = 20 \text{ mA}$ )

Red (CLM1B-RKW)

Bin Code	Min.(mcd)	Max.(mcd)
Ua	450	560
Ub	560	710
Va	710	900
Vb	900	1120

Amber (CLM1B-AKW)

Bin Code	Min.(mcd)	Max.(mcd)
Ua	450	560
Ub	560	710
Va	710	900
Vb	900	1120

Tolerance of measurement of luminous intensity is  $\pm 10\%$ .

### COLOR BIN LIMIT ( $I_F = 20 \text{ mA}$ )

Red (CLM1B-RKW)

Bin Code	Min.(nm)	Max.(nm)
RA	618	630

Amber (CLM1B-AKW)

Bin Code	Min.(nm)	Max.(nm)
A2	584	587
A3	587	590
A4	590	593
A5	593	596

Tolerance of measurement of dominant wavelength is  $\pm 1 \text{ nm}$ .

**ORDER CODE TABLE\***

Color	Kit Number	Viewing Angle	Luminous Intensity (mcd)		Dominant Wavelength			
			Min.	Max.	Color Bin	Min. (nm)	Color Bin	Max. (nm)
Red	CLM1B-RKW-CUaVbAA3	120	450	1120	RA	618	RA	630
Red	CLM1B-RKW-CUbVbAA3	120	560	1120	RA	618	RA	630

Color	Kit Number	Viewing Angle	Luminous Intensity (mcd)		Dominant Wavelength			
			Min.	Max.	Color Bin	Min. (nm)	Color Bin	Max. (nm)
Amber	CLM1B-AKW-CUaVb253	120	450	1120	A2	584	A5	596
Amber	CLM1B-AKW-CUbVb353	120	560	1120	A3	587	A5	596
Amber	CLM1B-AKW-CVaVb353	120	710	1120	A3	587	A5	596

Notes:

1. The above kit numbers represent order codes that include multiple intensity-bin and color-bin codes. Only one intensity-bin code and one color-bin code will be shipped on each bulk. Single intensity-bin code and single color-bin codes will not be orderable.
2. Please refer to the "Cree LED Lamp Reliability Test Standards" document for reliability test conditions.
3. Please refer to the "Cree LED Lamp Soldering & Handling" document for information about how to use this LED product safely.

GRAPHS

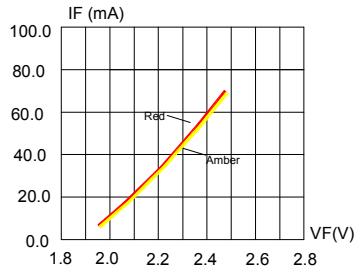

FIG.1 FORWARD CURRENT VS.

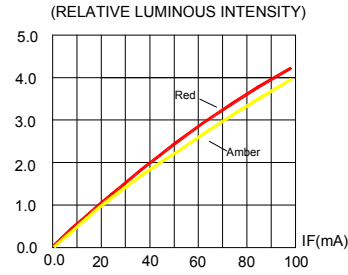

FIG.2 RELATIVE LUMINOUS INTENSITY VS. FORWARD CURRENT

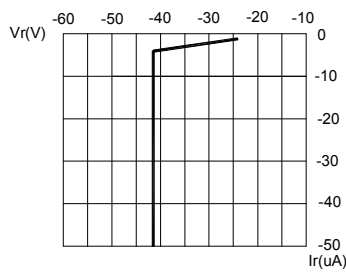

FIG.3 RED&AMBER REVERSE CURRENT VS. REVERSE VOLTAGE.

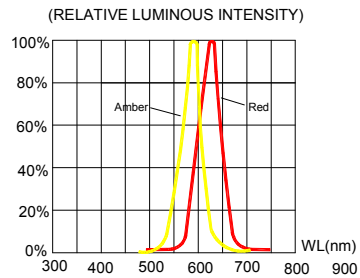

FIG.4 RELATIVE LUMINOUS INTENSITY VS. WAVELENGTH.

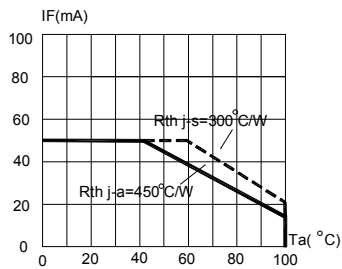

FIG.5 RED&AMBER MAXIMUM FORWARD DC CURRENT VS AMBIENT TEMPERATURE ( $T_{jmax}=110^{\circ}C$ )

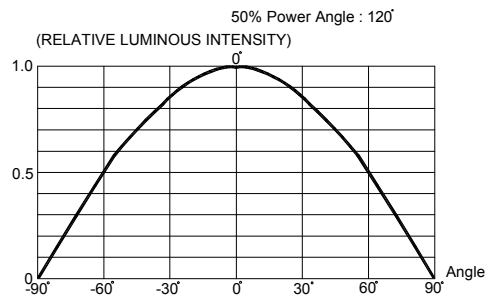
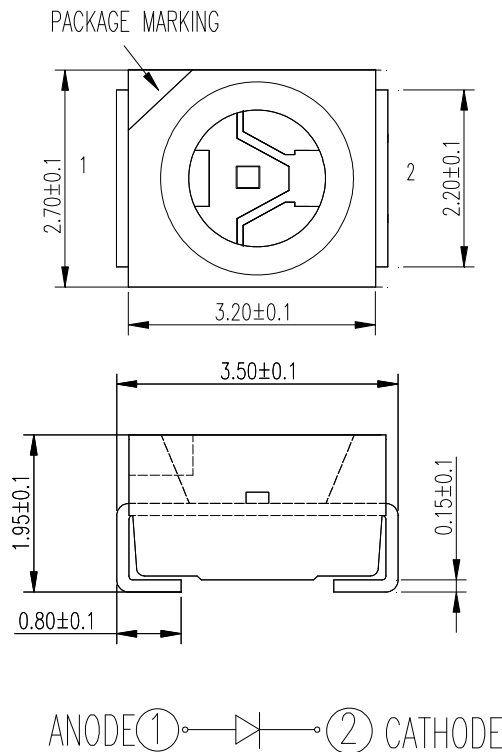

FIG.6 FAR FIELD PATTERN

The above data are collected from statistical figures that do not necessarily correspond to the actual parameters of each single LED. Hence, these data will be changed without further notice.

## MECHANICAL DIMENSIONS

All dimensions are in mm.



## NOTES

### RoHS Compliance

The levels of environmentally sensitive, persistent biologically toxic (PBT), persistent organic pollutants (POP), or otherwise restricted materials in this product are below the maximum concentration values (also referred to as the threshold limits) permitted for such substances, or are used in an exempted application, in accordance with EU Directive 2002/95/EC on the restriction of the use of certain hazardous substances in electrical and electronic equipment (RoHS), as amended through April 21, 2006.

### Vision Advisory Claim

Users should be cautioned not to stare at the light of this LED product. The bright light can damage the eye.

## KIT NUMBER SYSTEM

Cree LED lamps are tested and sorted into performance bins. A bin is specified by ranges of color, forward voltage, and brightness. Sorted LEDs are packaged for shipping in various convenient options. Please refer to the "Cree LED Lamp Packaging Standard" document for more information about shipping and packaging options.

Cree LEDs are sold by order codes in combinations of bins called kits. Order codes are configured in the following manner:



**PACKAGING**

- The boxes are not water resistant and they must be kept away from water and moisture.
- The LEDs are packed in cardboard boxes after packaging in normal or anti-electrostatic bags.
- Cardboard boxes will be used to protect the LEDs from mechanical shocks during transportation.
- The reel pack is applied in SMD LED.
- Max 2000 pcs per reel.

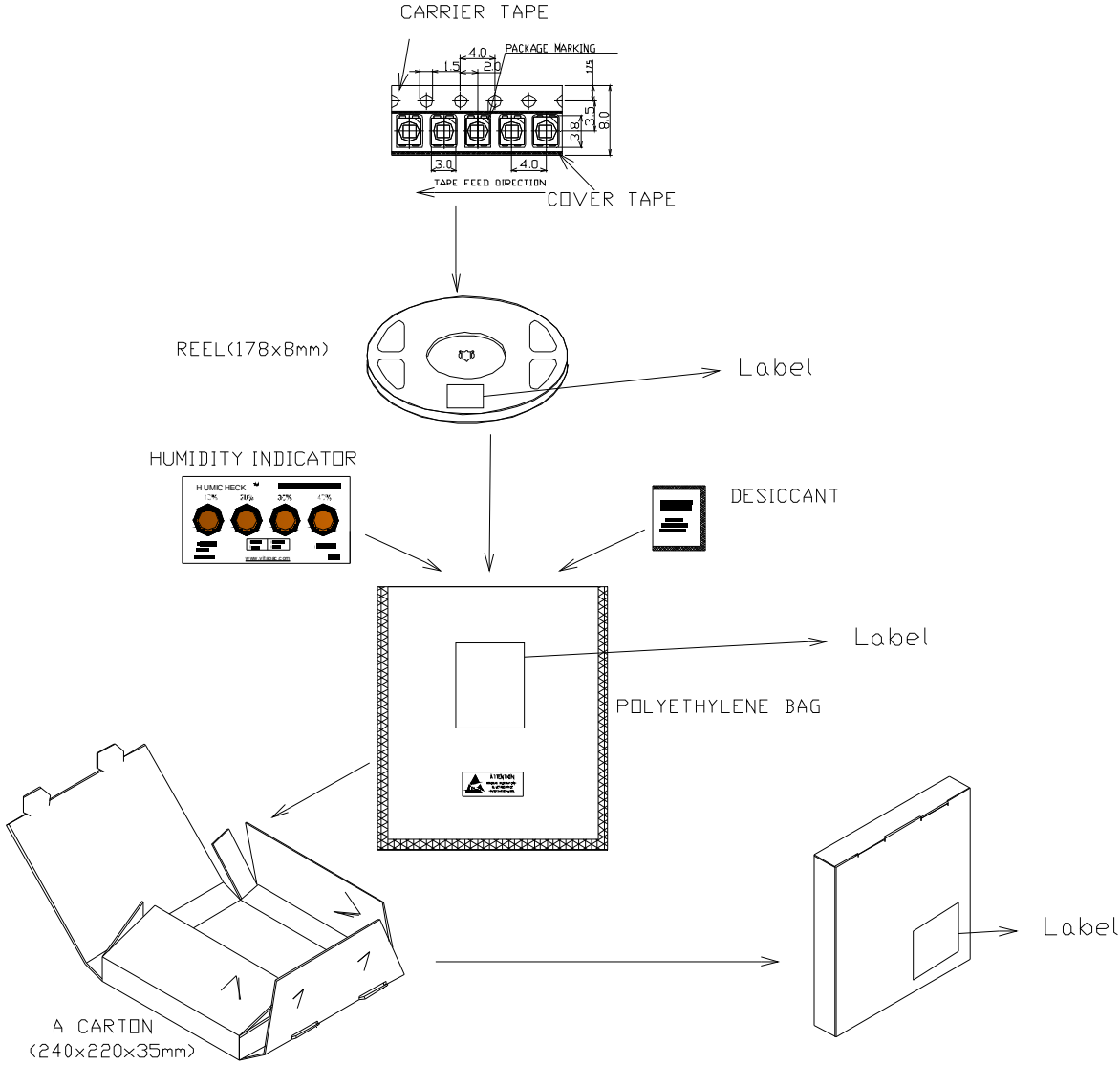





## Стандарт Электрон Связь

Мы молодая и активно развивающаяся компания в области поставок электронных компонентов. Мы поставляем электронные компоненты отечественного и импортного производства напрямую от производителей и с крупнейших складов мира.

Благодаря сотрудничеству с мировыми поставщиками мы осуществляем комплексные и плановые поставки широчайшего спектра электронных компонентов.

Собственная эффективная логистика и склад в обеспечивает надежную поставку продукции в точно указанные сроки по всей России.

Мы осуществляем техническую поддержку нашим клиентам и предпродажную проверку качества продукции. На все поставляемые продукты мы предоставляем гарантию .

Осуществляем поставки продукции под контролем ВП МО РФ на предприятия военно-промышленного комплекса России , а также работаем в рамках 275 ФЗ с открытием отдельных счетов в уполномоченном банке. Система менеджмента качества компании соответствует требованиям ГОСТ ISO 9001.

Минимальные сроки поставки, гибкие цены, неограниченный ассортимент и индивидуальный подход к клиентам являются основой для выстраивания долгосрочного и эффективного сотрудничества с предприятиями радиоэлектронной промышленности, предприятиями ВПК и научно-исследовательскими институтами России.

С нами вы становитесь еще успешнее!

### Наши контакты:

**Телефон:** +7 812 627 14 35

**Электронная почта:** [sales@st-electron.ru](mailto:sales@st-electron.ru)

**Адрес:** 198099, Санкт-Петербург,  
Промышленная ул, дом № 19, литера Н,  
помещение 100-Н Офис 331