

DESCRIPTION

Demonstration circuit 2520A shows the proper way to drive the LTC[®]2344 ADC. The LTC2344 is a low noise, high speed, simultaneous sampling 16-/18-bit successive approximation register (SAR) ADC. The LTC2344 has a flexible SoftSpan™ interface that allows conversion-by-conversion control of the input voltage span on a per-channel basis. An internal 2.048V reference and 2× buffer simplify basic operation while an external reference can be used to increase the input range and the SNR of the ADC.

The DC2520A demonstrates the DC and AC performance of the LTC2344 in conjunction with the DC590/DC2026 and DC890 data collection boards. Use the DC590/DC2026 to

demonstrate DC performance such as peak-to-peak noise and DC linearity. Use the DC890 if precise sampling rates are required or to demonstrate AC performance such as SNR, THD, SINAD and SFDR. The DC2520A is intended to demonstrate recommended grounding, component placement and selection, routing and bypassing for this ADC. A suggested driver circuit for the analog inputs is also presented.

Design files for this circuit board including the schematic, layout and BOM are available at

<http://www.linear.com/demo/DC2520A>

LT, LTC, LTM, Linear Technology and the Linear logo are registered trademarks and PScope, QuikEval and SoftSpan are trademarks of Linear Technology Corporation. All other trademarks are the property of their respective owners.

BOARD PHOTO

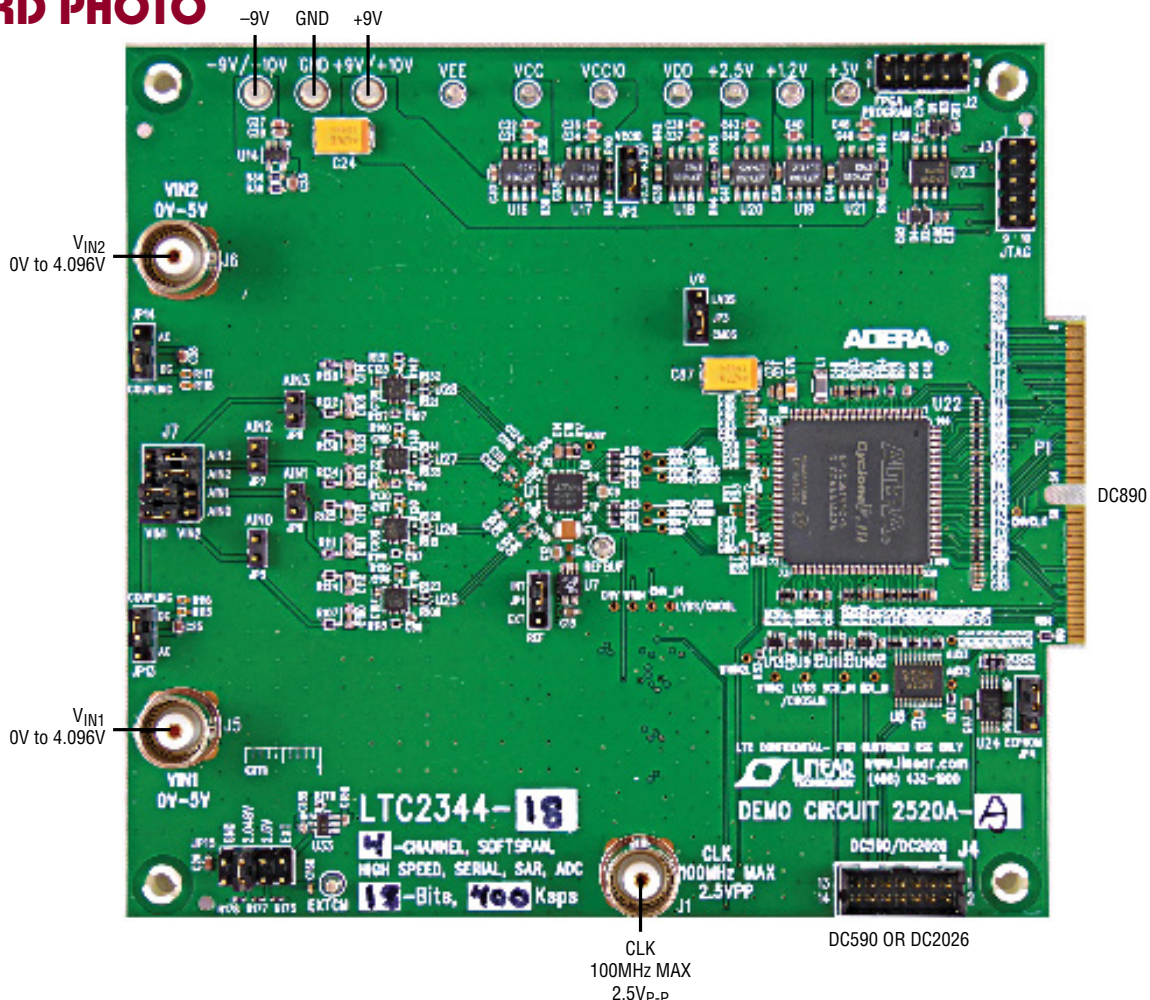

Figure 1. DC2520A Connection Diagram

ASSEMBLY OPTIONS

Assembly Version	U1 Part Number	Max Conversion Rate	Number of Channels	Number of Bits	Max CLK IN Frequency	CLK IN/fs Ratio
DC2520A-A	LTC2344-18	400ksps	4	18	68.8MHz	172
DC2520A-B	LTC2344-16	400ksps	4	16	68.8MHz	172

DC890 QUICK START PROCEDURE

Check to make sure that all jumpers are set to their default settings as described in the DC2520A Jumpers section of this manual. The default connections configure the ADC to use the onboard reference and regulators to generate all the required bias voltages. The analog inputs by default are DC coupled. Connect the DC2520A to a DC890 USB High Speed Data Collection Board using connector P1. Then, connect the DC890 to a host PC with a standard USB A/B cable. Apply $\pm 9V$ to the indicated terminals. Then apply a low jitter signal source to J5 and J6. Use J7 to route the signal sources of J5 and J6 to the desired AIN0-AIN3 inputs. Observe the recommended input voltage range for each analog input. Connect a low jitter 2.5V_{P-P} sine wave or square wave to connector J1. See the Assembly Options table for the appropriate clock frequency. Note that J1 has a 50 Ω termination resistor to ground.

Run the PScope™ software (Pscope.exe version K86 or later) which can be downloaded from www.linear.com/designtools/software.

Complete software documentation is available from the Help menu. Updates can be downloaded from the Tools menu. Check for updates periodically as new features may be added.

The PScope software should recognize the DC2520A and configure itself automatically.

Click the Collect button (See Figure 3) to begin acquiring data. The Collect button then changes to Pause, which can be clicked to stop data acquisition.

DC590/DC2026 QUICK START PROCEDURE

IMPORTANT! To avoid damage to the DC2520A, make sure that VCCIO (JP6 of the DC590, JP3 of the DC2026) of the DC590/DC2026 is set to 3.3V before connecting the DC590/DC2026 to the DC2520A.

To use the DC590/DC2026 with the DC2520A, it is necessary to apply $\pm 9V$ and ground to the $\pm 9V$ and GND terminals of the DC2520A. Connect the DC590/DC2026 to a host PC with a standard USB A/B cable. Connect the DC2520A to a DC590/DC2026 USB serial controller using the supplied 14-conductor ribbon cable. Apply a signal source to J5

and J6. Use J7 to route the signal sources of J5 and J6 to the desired AIN0-AIN3 inputs. No Clock is required on J1 when using the DC590/DC2026. The clock signal is provided by the DC590/DC2026.

Run the QuikEval software (quikeval.exe version K110 or later) which is available from www.linear.com/designtools/software. The correct control panel will be loaded automatically. Click the COLLECT button (Figure 6) to begin reading the ADC.

DC2520A SETUP

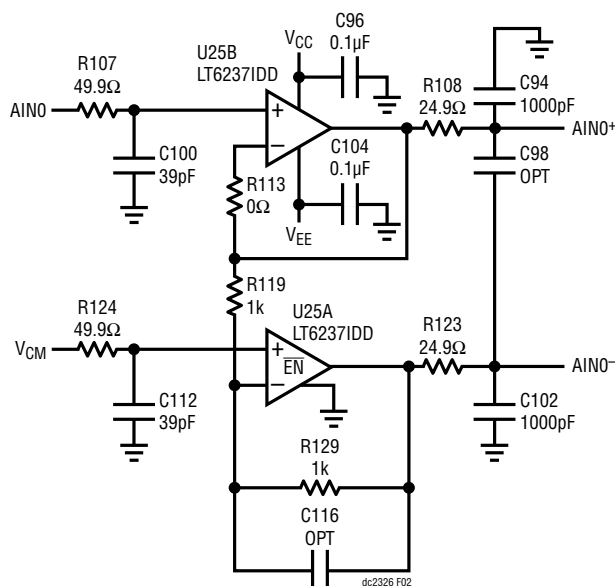

Figure 2. 0V–4.096V Single-Ended to Fully Differential DC Coupled Driver

DC Power

The DC2520A requires $\pm 9\text{VDC}$ and draws $+132\text{mA}/-52\text{mA}$. Most of the supply current is consumed by the FPGA, opamps, regulators and discrete logic on the board. The $\pm 9\text{VDC}$ input voltage powers the ADC through LT1763 regulators which provide protection against accidental reverse bias. Additional regulators provide power for the FPGA and opamps.

Clock Source

You must provide a low jitter $2.5\text{V}_{\text{p-p}}$ sine or square wave to the clock input, J1. The clock input is AC coupled so the DC level of the clock signal is not important. A generator such as the Rohde & Schwarz SMB100A high speed clock source is recommended to drive the clock input. Even a good generator can start to produce noticeable jitter at low frequencies. Therefore it is recommended for lower sample rates to divide down a higher frequency clock to the desired sample rate. The ratio of clock frequency to

conversion rate is shown in the Assembly Options table. If the clock input is to be driven with logic, it is recommended that the 49.9Ω termination resistor (R4) be removed. Driving R4 with discrete logic may result in slow rising edges. These slow rising edges may compromise the SNR of the converter in the presence of high-amplitude higher frequency input signals.

Data Output

Parallel data output from this board (0V to 2.5V default), if not connected to the DC890, can be acquired by a logic analyzer, and subsequently imported into a spreadsheet, or mathematical package depending on what form of digital signal processing is desired. Alternatively, the data can be fed directly into an application circuit. Use pin 50 of P1 to latch the data. The data should be latched using the negative edge of this signal. The data output signal levels at P1 can also be increased to 0V-3.3V if the application circuit requires a higher voltage. This is accomplished by moving JP2 to the 3.3V position.

DC2520A SETUP

Reference

The default reference is the LTC2344 internal 4.096V reference. Alternatively, if a higher reference voltage is desired, the LTC6655-5 reference (U7) can be used by setting the REF jumper (JP1) to the EXT position and installing a 0 Ω resistor in the R7 position. This should result in better SNR performance but may slightly degrade the THD performance of the LTC2345.

Analog Inputs

All eight inputs have the same driver circuitry. The circuit of Figure 2 shows the driver for AIN0. It provides a DC coupled single-ended to fully differential output to the analog inputs of the LTC2344 with a maximum 0V-4.096V input signal.

DC890 Data Collection

For SINAD, THD or SNR testing a low noise, low distortion generator such as the B&K Type 1051 or Stanford Research SR1 should be used. A low jitter RF oscillator such as the Rohde & Schwarz SMB100A is used to drive the clock input. This demo board is tested in house by attempting to duplicate the FFT plot shown in Typical Performance Characteristics section of the LTC2344 data sheet. This involves using a 68.8MHz clock source, along with a sinusoidal generator at a frequency of approximately 2kHz. The input signal level is approximately -1dBFS. A typical FFT obtained with DC2520A is shown in Figure 3. Note that to calculate the real SNR, the signal level (F1 amplitude = -1.081dB) has to be added back to the SNR that PScope displays. With the example shown in Figure 3 this means that the actual SNR would be 93.59dB instead of the 92.51dB that PScope displays. Taking the RMS sum of the recalculated SNR and the THD yields a SINAD of 93.50dB which is fairly close to the typical number for this ADC.

To change the default settings for the LTC2344 in PScope, click on the Set Demo Bd Options button in the PScope tool bar shown in Figure 4. This will open the Configure Channels menu of Figure 5. In this menu it is possible to set the input signal range setting for each channel. There is also a button to return PScope to the default DC2520A settings which are optimized for the default hardware settings of the DC2520A.

There are a number of scenarios that can produce misleading results when evaluating an ADC. One that is common is feeding the converter with an input frequency that is a sub-multiple of the sample rate, and which will only exercise a small subset of the possible output codes. The proper method is to pick an M/N frequency for the input sine wave frequency. N is the number of samples in the FFT. M is a prime number between one and N/2. Multiply M/N by the sample rate to obtain the input sine wave frequency. Another scenario that can yield poor results is if you do not have a signal generator capable of ppm frequency accuracy or if it cannot be locked to the clock frequency. You can use an FFT with windowing to reduce the “leakage” or spreading of the fundamental, to get a close approximation of the ADC performance. If an amplifier or clock source with poor phase noise is used, the windowing will not improve the SNR.

DC590/DC2026 Data Collection

Due to the relatively low and somewhat unpredictable sample rate of the DC590/DC2026 its usefulness is limited to noise measurement and data collection of slowly moving signals. A typical data capture and histogram are shown in Figure 6. To change the default settings for the LTC2344 in QuikEval, click on the Sequence Config button. This will open the Config Dialog menu of Figure 7. In this menu it is possible to set the input signal range for each sequence. There is also a button to return QuikEval to the default DC2520A settings which are optimized for the default hardware settings of the DC2520A.

DC2520A SETUP

Layout

As with any high performance ADC, this part is sensitive to layout. The area immediately surrounding the ADC on the DC2520A should be used as a guideline for placement, and routing of the various components associated with the ADC. Here are some things to remember when laying out a board for the LTC2344. A ground plane is necessary to obtain maximum performance. Keep bypass capacitors as close to supply pins as possible. Use individual low impedance returns for all bypass capacitors. Use of a symmetrical layout around the analog inputs will minimize the effects of parasitic elements. Shield analog input traces with ground to minimize coupling from other traces. Keep traces as short as possible.

Component Selection

When driving a low noise, low distortion ADC such as the LTC2344, component selection is important so as to not degrade performance. Resistors should have low values to minimize noise and distortion. Metal film resistors are recommended to reduce distortion caused by self heating. Because of their low voltage coefficients, to further reduce distortion NPO or silver mica capacitors should be used. Any buffer used to drive the LTC2344 should have low distortion, low noise and a fast settling time such as the LT6237.

DC2520A SETUP

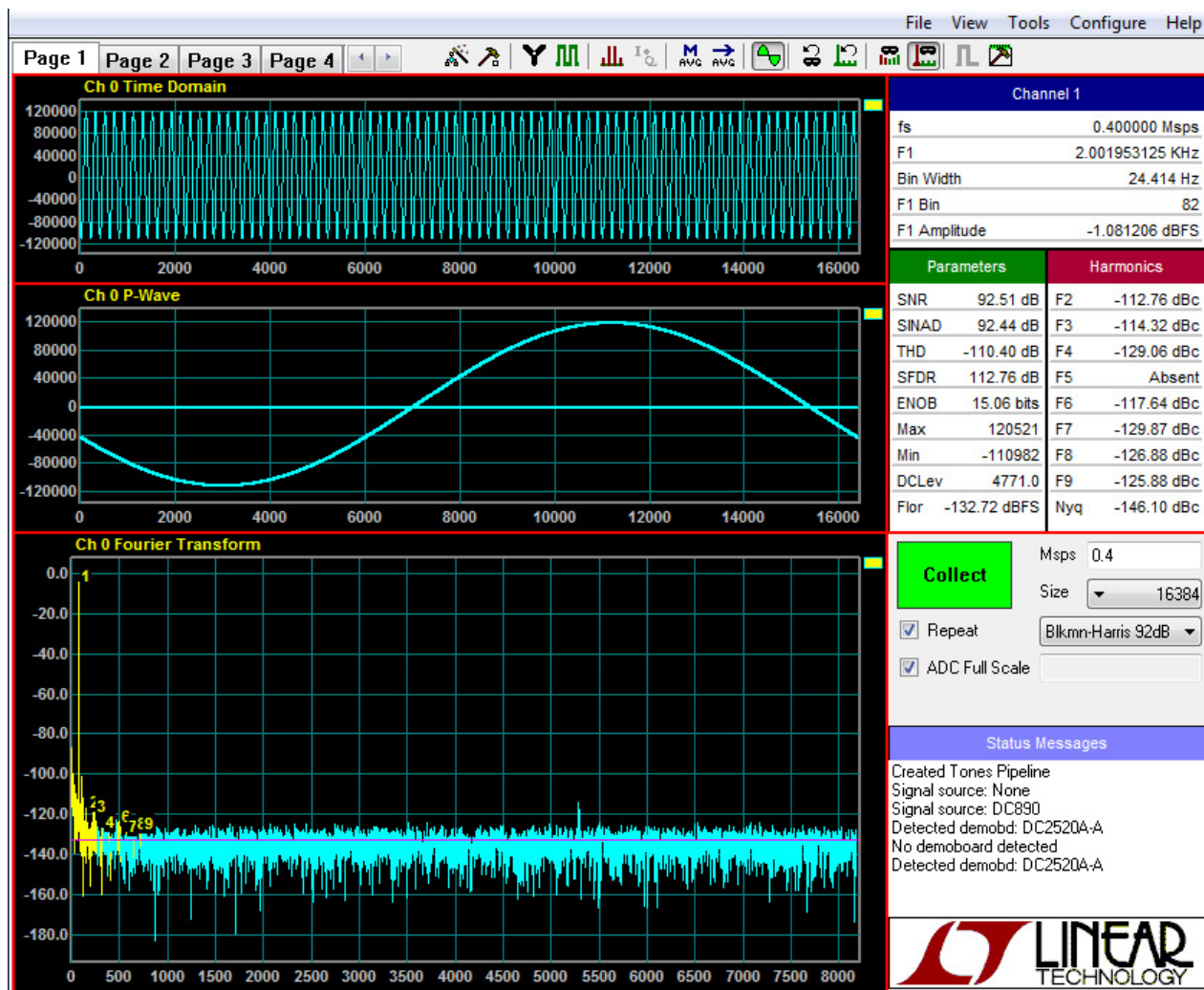

Figure 3. PScope Screen Shot

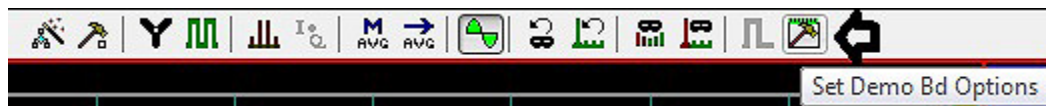

Figure 4. PScope Tool Bar

DC2520A SETUP

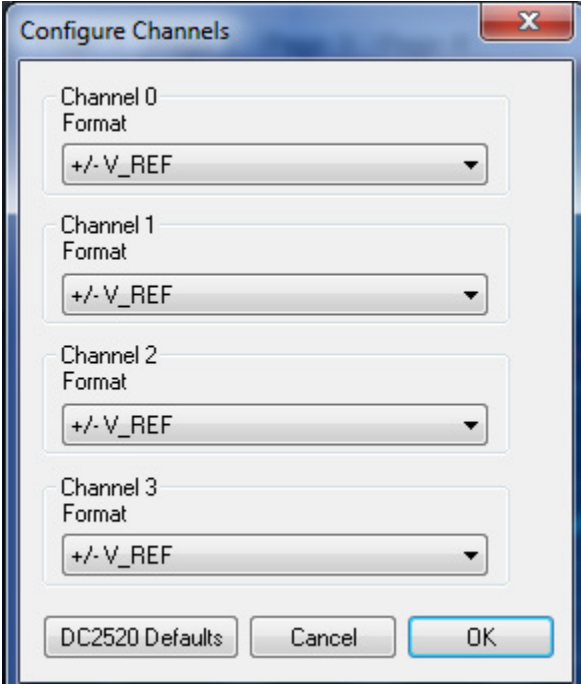

Figure 5. PScope Configuration Menu

DC2520A SETUP

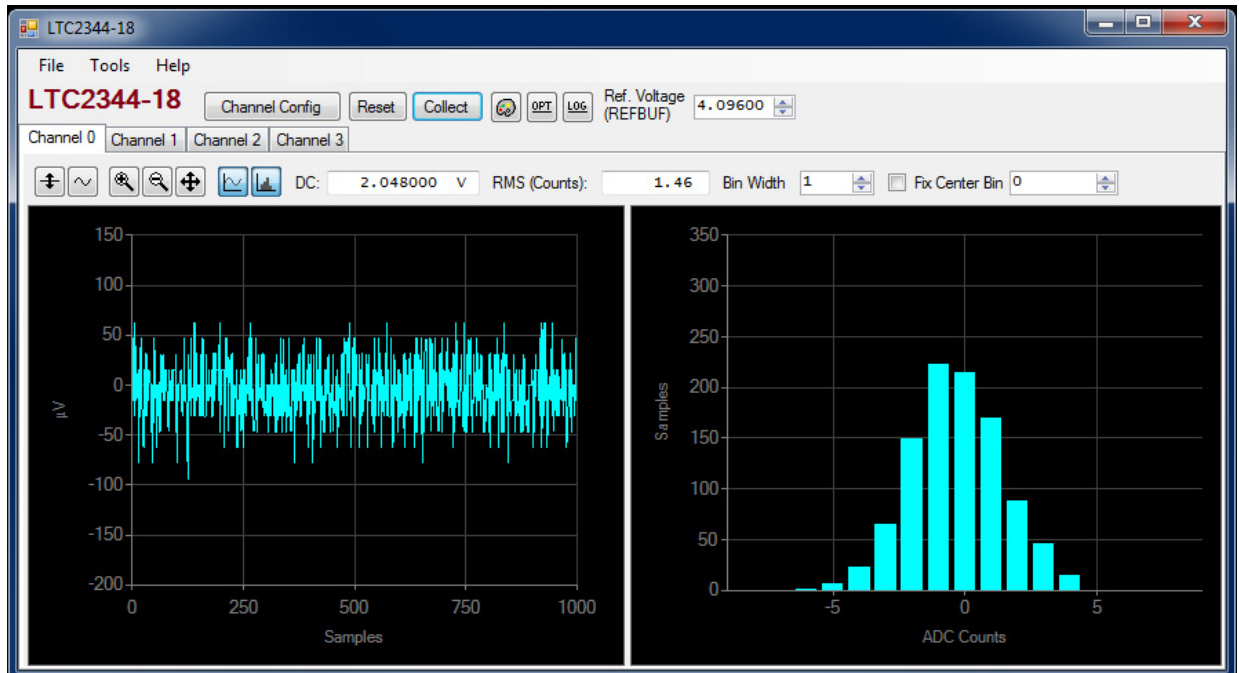

Figure 6. QuikEval Screen Shot

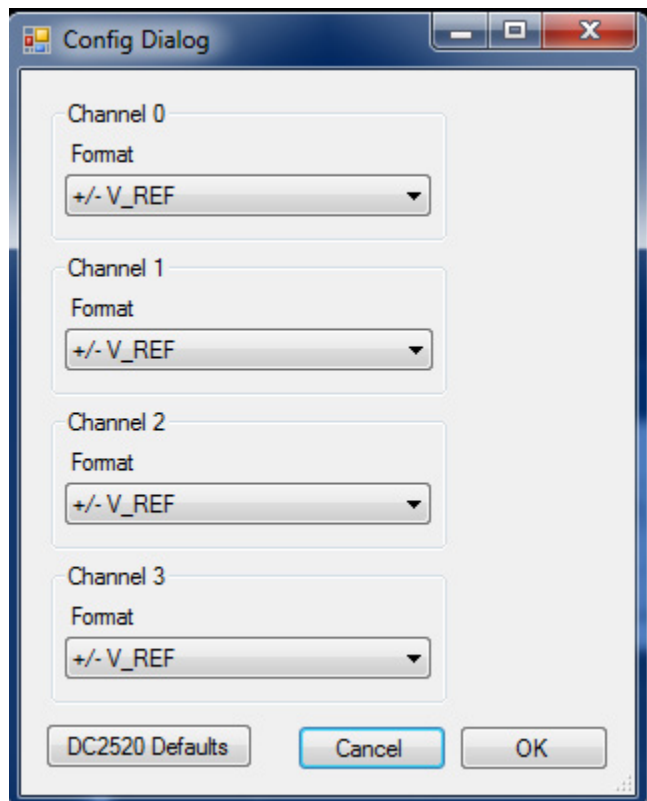

Figure 7. QuikEval Configuration Menu

DC2520A JUMPERS

Definitions

JP1: REF selects INT or EXT reference for the ADC. The default setting is INT.

JP2: VCCIO sets the output levels at P1 to either 3.3V or 2.5V. Use 2.5V to interface to the DC890 which is the default setting. Use 3.3V to interface to the DC2026.

JP3: I/O selects LVDS or CMOS logic levels. The default setting is CMOS. Only CMOS is currently supported.

JP4: EEPROM is for factory use only. The default position is WP.

JP5-JP6: AIN0-AIN3 can be used to short individual AIN inputs to ground or can be used drive the individual AIN inputs. The default is to leave these open.

JP13-JP14: Coupling selects AC or DC coupling for V_{IN1} and V_{IN2} . Default setting is DC.

JP15: Sets V_{CM} for the single-end to differential drivers of AIN0-AIN3

DC2520A CONNECTORS

Definitions

P1: DC890 interface is used to communicate with the DC890 controller.

J1: CLK provides the master clock for the DC2520A when interfaced to the DC890.

J2: FPGA PROGRAM is used to program the FPGA. This is for factory use only.

J3: JTAG is for factory use only.

J4: DC590/DC2026 interface is used to communicate with the DC2026 Linduino controller or DC590.

J5 and J6: Provide analog input voltages to AIN0-AIN3 of the ADC.

J7: Routes the signals of J5 and J6 to AIN0-AIN3.

DEMO MANUAL DC2520A

DEMONSTRATION BOARD IMPORTANT NOTICE

Linear Technology Corporation (LTC) provides the enclosed product(s) under the following **AS IS** conditions:

This demonstration board (DEMO BOARD) kit being sold or provided by Linear Technology is intended for use for **ENGINEERING DEVELOPMENT OR EVALUATION PURPOSES ONLY** and is not provided by LTC for commercial use. As such, the DEMO BOARD herein may not be complete in terms of required design-, marketing-, and/or manufacturing-related protective considerations, including but not limited to product safety measures typically found in finished commercial goods. As a prototype, this product does not fall within the scope of the European Union directive on electromagnetic compatibility and therefore may or may not meet the technical requirements of the directive, or other regulations.

If this evaluation kit does not meet the specifications recited in the DEMO BOARD manual the kit may be returned within 30 days from the date of delivery for a full refund. **THE FOREGOING WARRANTY IS THE EXCLUSIVE WARRANTY MADE BY THE SELLER TO BUYER AND IS IN LIEU OF ALL OTHER WARRANTIES, EXPRESSED, IMPLIED, OR STATUTORY, INCLUDING ANY WARRANTY OF MERCHANTABILITY OR FITNESS FOR ANY PARTICULAR PURPOSE. EXCEPT TO THE EXTENT OF THIS INDEMNITY, NEITHER PARTY SHALL BE LIABLE TO THE OTHER FOR ANY INDIRECT, SPECIAL, INCIDENTAL, OR CONSEQUENTIAL DAMAGES.**

The user assumes all responsibility and liability for proper and safe handling of the goods. Further, the user releases LTC from all claims arising from the handling or use of the goods. Due to the open construction of the product, it is the user's responsibility to take any and all appropriate precautions with regard to electrostatic discharge. Also be aware that the products herein may not be regulatory compliant or agency certified (FCC, UL, CE, etc.).

No License is granted under any patent right or other intellectual property whatsoever. **LTC assumes no liability for applications assistance, customer product design, software performance, or infringement of patents or any other intellectual property rights of any kind.**

LTC currently services a variety of customers for products around the world, and therefore this transaction **is not exclusive**.

Please read the DEMO BOARD manual prior to handling the product. Persons handling this product must have electronics training and observe good laboratory practice standards. **Common sense is encouraged.**

This notice contains important safety information about temperatures and voltages. For further safety concerns, please contact a LTC application engineer.

Mailing Address:

Linear Technology
1630 McCarthy Blvd.
Milpitas, CA 95035

Copyright © 2004, Linear Technology Corporation



Стандарт Электрон Связь

Мы молодая и активно развивающаяся компания в области поставок электронных компонентов. Мы поставляем электронные компоненты отечественного и импортного производства напрямую от производителей и с крупнейших складов мира.

Благодаря сотрудничеству с мировыми поставщиками мы осуществляем комплексные и плановые поставки широчайшего спектра электронных компонентов.

Собственная эффективная логистика и склад в обеспечивает надежную поставку продукции в точно указанные сроки по всей России.

Мы осуществляем техническую поддержку нашим клиентам и предпродажную проверку качества продукции. На все поставляемые продукты мы предоставляем гарантию .

Осуществляем поставки продукции под контролем ВП МО РФ на предприятия военно-промышленного комплекса России , а также работаем в рамках 275 ФЗ с открытием отдельных счетов в уполномоченном банке. Система менеджмента качества компании соответствует требованиям ГОСТ ISO 9001.

Минимальные сроки поставки, гибкие цены, неограниченный ассортимент и индивидуальный подход к клиентам являются основой для выстраивания долгосрочного и эффективного сотрудничества с предприятиями радиоэлектронной промышленности, предприятиями ВПК и научно-исследовательскими институтами России.

С нами вы становитесь еще успешнее!

Наши контакты:

Телефон: +7 812 627 14 35

Электронная почта: sales@st-electron.ru

Адрес: 198099, Санкт-Петербург,
Промышленная ул, дом № 19, литера Н,
помещение 100-Н Офис 331