

Features

- Low Forward Voltage Drop
- Fast Switching
- Very High Density (Five Diode Elements in a Sub-Miniature Package)
- **Lead Free/RoHS Compliant (Note 1)**
- **"Green" Device (Note 2)**
- **Qualified to AEC-Q101 Standards for High Reliability**

Mechanical Data

- Case: DFN1616-6
- Case Material: Molded Plastic, "Green" Molding Compound. UL Flammability Classification Rating 94V-0
- Moisture Sensitivity: Level 1 per J-STD-020D
- Terminals: Solderable per MIL-STD-202, Method 208
- Lead Free Plating (NiPdAu Finish over Copper leadframe).
- Polarity: Pin 1 Dot and Center Pad notch, See diagram
- Marking Information: See Page 2
- Ordering Information: See Page 2
- Weight: 0.004 grams (approximate)

DFN1616-6

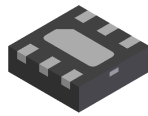

BOTTOM VIEW

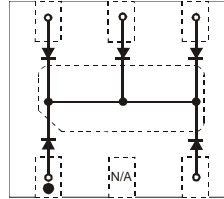
 TOP VIEW
Internal Schematic

Maximum Ratings @ $T_A = 25^\circ\text{C}$ unless otherwise specified

Characteristic	Symbol	Value	Unit
Non-Repetitive Peak Reverse Voltage	V_{RM}	100	V
Peak Repetitive Reverse Voltage	V_{RRM}	75	V
Working Peak Reverse Voltage	V_{RWM}		
DC Blocking Voltage	V_R		
RMS Reverse Voltage	$V_{R(RMS)}$	53	V
Forward Continuous Current	I_{FM}	300	mA
Average Rectified Output Current	I_O	200	mA
Non-Repetitive Peak Forward Surge Current	I_{FSM}	2.0	A
	@ $t = 1.0\mu\text{s}$	1.0	
	@ $t = 1.0\text{s}$		

Thermal Characteristics

Characteristic	Symbol	Value	Unit
Power Dissipation (Note 3)	P_D	500	mW
Thermal Resistance Junction to Ambient Air (Note 3)	$R_{\theta JA}$	256	$^\circ\text{C/W}$
Operating and Storage Temperature Range	T_J, T_{STG}	-65 to +150	$^\circ\text{C}$

Electrical Characteristics @ $T_A = 25^\circ\text{C}$ unless otherwise specified

Characteristic	Symbol	Min	Max	Unit	Test Condition
Reverse Breakdown Voltage (Note 4)	$V_{(BR)R}$	75	—	V	$I_R = 100\mu\text{A}$
Forward Voltage	V_F	—	0.715	V	$I_F = 1.0\text{mA}$
			0.855		$I_F = 10\text{mA}$
			1.0		$I_F = 50\text{mA}$
			1.25		$I_F = 150\text{mA}$
Leakage Current (Note 4)	I_R	—	1.0	μA	$V_R = 75\text{V}$
			50		$V_R = 75\text{V}, T_J = 150^\circ\text{C}$
			30		$V_R = 25\text{V}, T_J = 150^\circ\text{C}$
			25		$V_R = 20\text{V}$
Total Capacitance	C_T	—	2.0	pF	$V_R = 0, f = 1.0\text{MHz}$
Reverse Recovery Time	t_{rr}	—	4.0	ns	$I_F = I_R = 10\text{mA}, I_{rr} = 0.1 \times I_R, R_L = 100\Omega$

- Notes:
1. No Purposefully added Lead.
 2. Diodes Inc.'s "Green" policy can be found on our website at http://www.diodes.com/products/lead_free/index.php.
 3. Part mounted on FR-4 PC board with recommended pad layout, which can be found on our website at <http://www.diodes.com/datasheets/ap02001.pdf>. Only one switching diode powered on.
 4. Short duration pulse test used to minimize self-heating effect.

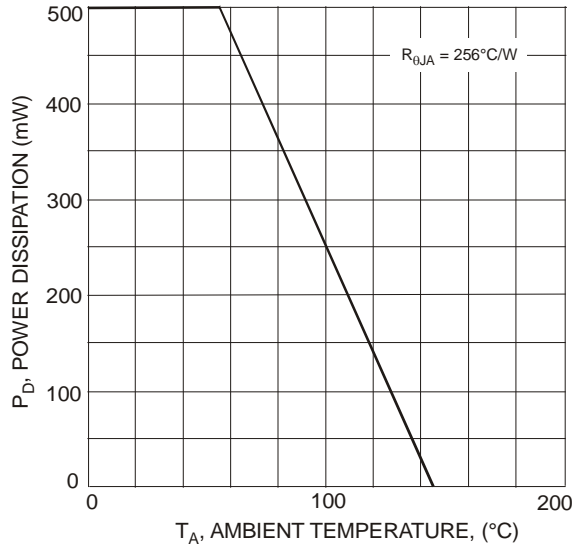

Fig. 1 Power Derating Curve

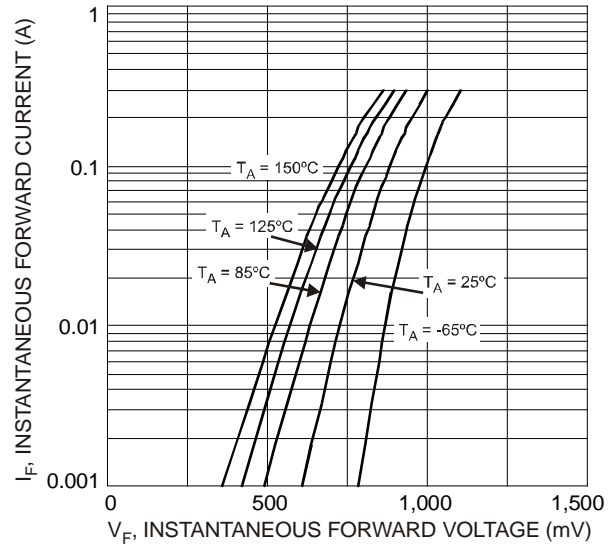

Fig. 2 Typical Forward Characteristics

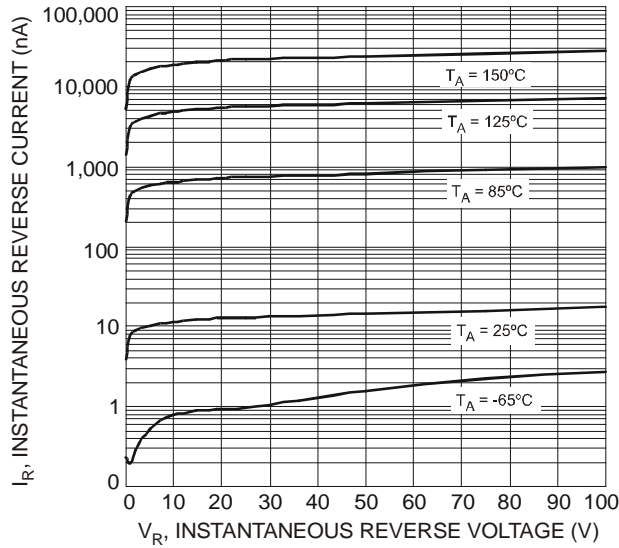

Fig. 3 Typical Reverse Characteristics

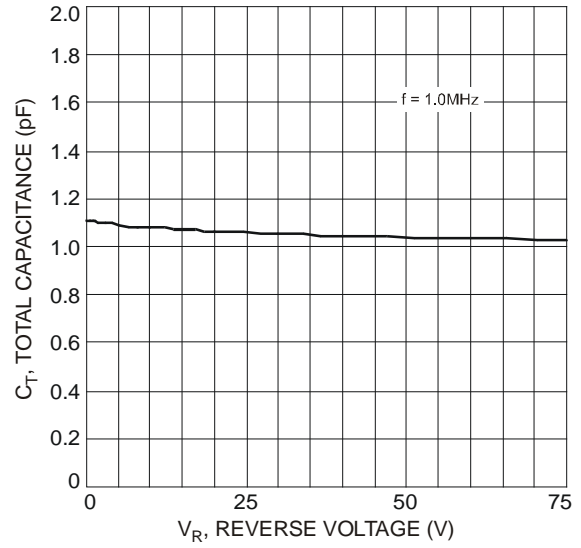

Fig. 4 Typical Capacitance vs. Reverse Voltage

Ordering Information (Note 5)

Part Number	Case	Packaging
MMBD4148PLM-7	DFN1616-6	3000/Tape & Reel

Notes: 5. For packaging details, go to our website at <http://www.diodes.com/datasheets/ap02007.pdf>.

Marking Information

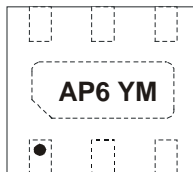

AP6 = Product Type Marking Code
 YM = Date Code Marking
 Y = Year ex: V = 2008
 M = Month ex: 9 = September

Date Code Key

Year	2008	2009	2010	2011	2012	2013	2014	2015
Code	V	W	X	Y	Z	A	B	C

Month	Jan	Feb	Mar	Apr	May	Jun	Jul	Aug	Sep	Oct	Nov	Dec
Code	1	2	3	4	5	6	7	8	9	O	N	D

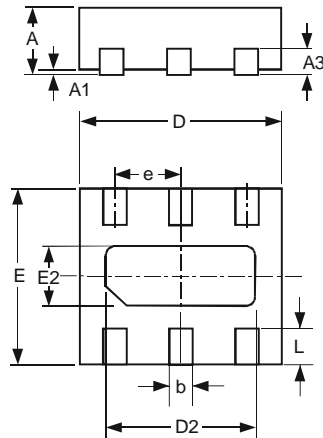
Package Outline Dimensions

DFN1616-6			
Dim	Min	Max	Typ
A	0.545	0.605	0.575
A1	0	0.05	0.02
A3	—	—	0.13
b	0.20	0.30	0.25
D	1.55	1.675	1.60
D2	1.10	1.30	1.20
E	1.55	1.675	1.60
e	—	—	0.50
E2	0.30	0.50	0.40
L	0.275	0.375	0.325
All Dimensions in mm			

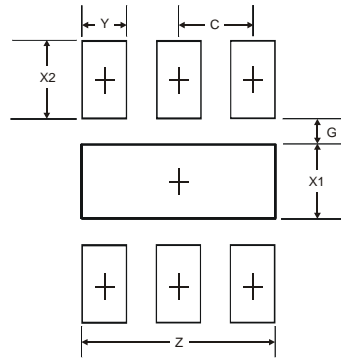
Suggested Pad Layout

Dimensions	Value (in mm)
Z	1.3
G	0.175
X1	0.50
X2	0.525
Y	0.30
C	0.50

IMPORTANT NOTICE

Diodes Incorporated and its subsidiaries reserve the right to make modifications, enhancements, improvements, corrections or other changes without further notice to any product herein. Diodes Incorporated does not assume any liability arising out of the application or use of any product described herein; neither does it convey any license under its patent rights, nor the rights of others. The user of products in such applications shall assume all risks of such use and will agree to hold Diodes Incorporated and all the companies whose products are represented on our website, harmless against all damages.

LIFE SUPPORT

Diodes Incorporated products are not authorized for use as critical components in life support devices or systems without the expressed written approval of the President of Diodes Incorporated.



Стандарт Электрон Связь

Мы молодая и активно развивающаяся компания в области поставок электронных компонентов. Мы поставляем электронные компоненты отечественного и импортного производства напрямую от производителей и с крупнейших складов мира.

Благодаря сотрудничеству с мировыми поставщиками мы осуществляем комплексные и плановые поставки широчайшего спектра электронных компонентов.

Собственная эффективная логистика и склад в обеспечивает надежную поставку продукции в точно указанные сроки по всей России.

Мы осуществляем техническую поддержку нашим клиентам и предпродажную проверку качества продукции. На все поставляемые продукты мы предоставляем гарантию .

Осуществляем поставки продукции под контролем ВП МО РФ на предприятия военно-промышленного комплекса России , а также работаем в рамках 275 ФЗ с открытием отдельных счетов в уполномоченном банке. Система менеджмента качества компании соответствует требованиям ГОСТ ISO 9001.

Минимальные сроки поставки, гибкие цены, неограниченный ассортимент и индивидуальный подход к клиентам являются основой для выстраивания долгосрочного и эффективного сотрудничества с предприятиями радиоэлектронной промышленности, предприятиями ВПК и научно-исследовательскими институтами России.

С нами вы становитесь еще успешнее!

Наши контакты:

Телефон: +7 812 627 14 35

Электронная почта: sales@st-electron.ru

Адрес: 198099, Санкт-Петербург,
Промышленная ул, дом № 19, литера Н,
помещение 100-Н Офис 331