



Features

- Radial leaded devices
- Cured, flame retardant epoxy polymer insulating material meets UL 94V-0 requirements
- Bulk packaging, tape and reel available
- Resettable circuit protection
- Agency recognition:  
- RoHS compliant*

Applications

- Food blenders, coffee machines
- HVAC
- Electric fans, blowers
- AC adaptors

MF-RM Series - PTC Resettable Fuses

Electrical Characteristics

Model	Typical Current Trip Limit		V _{max}		I _{max}	Initial Resistance	One Hour Post-Trip Resistance	Max. Time to Trip		Tripped Power Dissipation
	I _{hold} at 23 °C	I _{trip} at 23 °C	Operating Voltage	Interrupt Voltage	Interrupt Current	R _{Min.} at 23 °C	R ₁ Max. at 23 °C	at 23 °C		PD Typ. at 23 °C
	(A)	(A)	(Vac)	(Vac)	(A)	(Ohms)	(Ohms)	(A)	(Sec.)	(W)
MF-RM005/240	0.05	0.12	240	265	1.0	18.50	65.00	0.25	10.0	0.9
MF-RM008/240	0.08	0.19	240	265	1.2	7.40	26.00	0.40	10.0	0.9
MF-RM012/240	0.12	0.30	240	265	1.2	3.00	12.00	0.60	15.0	1.0
MF-RM016/240	0.16	0.37	240	265	2.0	2.50	7.80	0.80	15.0	1.4
MF-RM025/240	0.25	0.56	240	265	3.5	1.30	3.80	1.25	18.5	1.5
MF-RM033/240	0.33	0.74	240	265	4.5	0.77	2.60	1.65	21.0	1.7
MF-RM040/240	0.40	0.90	240	265	5.5	0.60	1.90	2.00	24.0	2.0
MF-RM055/240	0.55	1.25	240	265	7.0	0.45	1.45	2.75	26.0	3.4

Environmental Characteristics

Operating Temperature.....	-20 °C to +85 °C
Humidity Aging.....	+85 °C, 85 % R.H. 1000 hours±20 % typical resistance change
Passive Aging.....	+85 °C, 1000 hours.....±20 % typical resistance change
Vibration	MIL-STD-883C, Method 2007.1,.....No change Condition A
Solvent Resistance.....	MIL-STD-202, Method 215No change

Test Procedures And Requirements For Model MF-RM Series

Item	Test Conditions	Accept/Reject Criteria
Visual/Mechanical.....	Verify dimensions and material.....	Per MF physical description
Resistance.....	In still air @ 23 °C.....	R _{min} ≤ R ≤ R _{1max}
Time to Trip.....	240 Vac, specified current	T ≤ max. time to trip
Hold Current.....	At I _{hold}	No trip
Trip Cycle Life.....	240 Vac, I _{max} , 100 cycles	No arcing or burning
Trip Endurance	a) 240 Vac, I _{max} , 24 hours	No arcing or burning
	b) 265 Vac, I _{max} , 30 mins.	
Solderability.....	MIL-STD-202, Method 208	95 % min. coverage

UL File Number [E174545](#)
 TÜV Certificate Number [R50232433](#)

*RoHS Directive 2002/95/EC Jan. 27, 2003 including annex and RoHS Recast 2011/65/EU June 8, 2011.
 Specifications are subject to change without notice.
 Customers should verify actual device performance in their specific applications.

Advantages

- Resettable feature with overtemperature and overcurrent protection can save expensive components from having to be replaced after tripping, e.g., transformers with built in thermal fuses
- Faster than bimetallic switch designs that take on average approximately 30 seconds to cool down and reset
- Generally lower electromagnetic interference than bimetallic switches

Benefits

- Reduced repair and replacement costs
- Reduced nuisance tripping
- Combined overcurrent and overtemperature protector in one device

MF-RM Series - PTC Resettable Fuses

BOURNS®

Thermal Derating Chart - I_{hold} (Amps)

Model	Ambient Operating Temperature							
	-20 °C	0 °C	23 °C	40 °C	50 °C	60 °C	70 °C	85 °C
MF-RM005/240	0.08	0.06	0.05	0.04	0.04	0.03	0.03	0.02
MF-RM008/240	0.12	0.10	0.08	0.07	0.06	0.05	0.04	0.03
MF-RM012/240	0.18	0.15	0.12	0.10	0.09	0.07	0.06	0.04
MF-RM016/240	0.24	0.20	0.16	0.13	0.11	0.10	0.08	0.05
MF-RM025/240	0.38	0.32	0.25	0.21	0.18	0.15	0.13	0.09
MF-RM033/240	0.50	0.42	0.33	0.27	0.23	0.20	0.17	0.11
MF-RM040/240	0.61	0.51	0.40	0.33	0.28	0.24	0.20	0.14
MF-RM055/240	0.80	0.68	0.55	0.46	0.40	0.35	0.29	0.22

Product Dimensions

Model	A Max.	B Max.	C		D Min.	E Max.	Physical Characteristics		
			Nom.	Tol. ±			Style	Lead Dia.	Material
MF-RM005/240	8.3 (0.327)	12.9 (0.508)	5.1 (0.201)	0.7 (0.028)	7.6 (0.299)	3.8 (0.150)	1	0.51 (0.020)	Sn/Cu
MF-RM008/240	8.3 (0.327)	12.9 (0.508)	5.1 (0.201)	0.7 (0.028)	7.6 (0.299)	3.8 (0.150)	1	0.51 (0.020)	Sn/Cu
MF-RM012/240	8.3 (0.327)	12.9 (0.508)	5.1 (0.201)	0.7 (0.028)	7.6 (0.299)	3.8 (0.150)	1	0.51 (0.020)	Sn/Cu
MF-RM016/240	9.9 (0.390)	13.8 (0.543)	5.1 (0.201)	0.7 (0.028)	7.6 (0.299)	3.8 (0.150)	1	0.51 (0.020)	Sn/Cu
MF-RM025/240	10.0 (0.394)	20.0 (0.787)	5.1 (0.201)	0.7 (0.028)	7.6 (0.299)	3.8 (0.150)	2	0.65 (0.026)	Sn/Cu
MF-RM033/240	11.4 (0.449)	20.0 (0.787)	5.1 (0.201)	0.7 (0.028)	7.6 (0.299)	3.8 (0.150)	2	0.65 (0.026)	Sn/Cu
MF-RM040/240	11.5 (0.453)	20.9 (0.823)	5.1 (0.201)	0.7 (0.028)	7.6 (0.299)	3.8 (0.150)	2	0.65 (0.026)	Sn/Cu
MF-RM055/240	14.0 (0.551)	22.4 (0.882)	5.1 (0.201)	0.7 (0.028)	7.6 (0.299)	4.1 (0.161)	2	0.81 (0.032)	Sn/Cu

Packaging options:

BULK: 500 pcs. per bag.

TAPE & REEL: 2000 pcs. per reel (MF-RM005/240~MF-RM040/240); 1000 pcs. per reel (MF-RM055/240)

0.51 (24AWG)

0.65 (22AWG)

0.81 (20AWG)

DIMENSIONS: $\frac{\text{MM}}{\text{(INCHES)}}$

Style 1

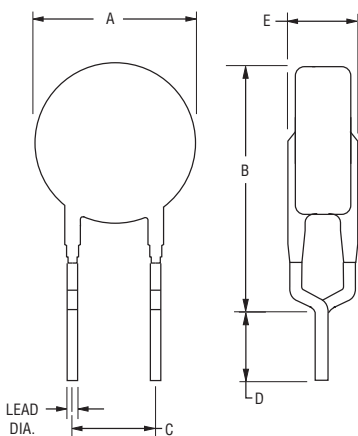

Style 2

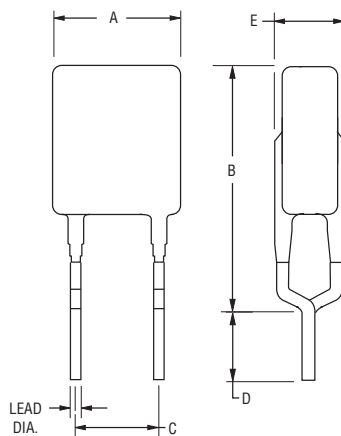

Typical Part Marking

Represents total content. Layout may vary.

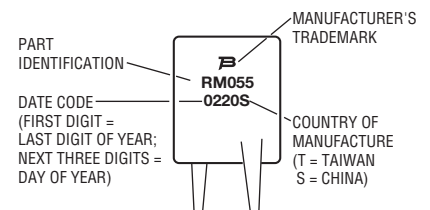

Specifications are subject to change without notice.

Customers should verify actual device performance in their specific applications.

MF-RM Series - PTC Resettable Fuses

BOURNS®

Typical Time to Trip at 23 °C

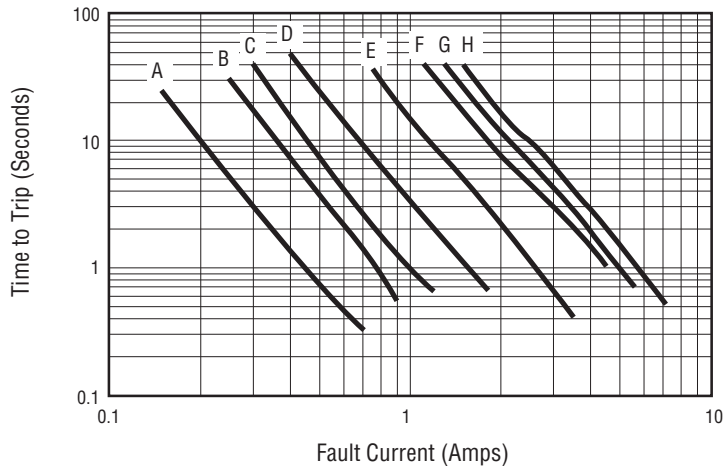

- A = MF-RM005/240
- B = MF-RM008/240
- C = MF-RM012/240
- D = MF-RM016/240
- E = MF-RM025/240
- F = MF-RM033/240
- G = MF-RM040/240
- H = MF-RM055/240

How to Order

MF - RM 005 / 240 - 2

Multifuse®
Product Designator

Series
RM = Radial Leaded Component

Hold Current, I_{hold}
005-055 (0.05 Amps - 0.55 Amps)

Operating Voltage, V_{max}
240 = 240 Vac

Packaging Options
- 0 = Bulk Packaging
- 2 = Tape and Reel

*Packaged per EIA486-B

BOURNS®

Asia-Pacific: Tel: +886-2 2562-4117 • Fax: +886-2 2562-4116

Europe: Tel: +41-41 768 5555 • Fax: +41-41 768 5510

The Americas: Tel: +1-951 781-5500 • Fax: +1-951 781-5700

www.bourns.com

MF-RM Series Tape and Reel Specifications

BOURNS®

Devices taped using EIA468-B/IEC60286-2 standards. See table below and Figures 1 and 2 for details.

Dimension Description	IEC Mark	EIA Mark	Dimensions	
			Dimensions	Tolerance
Carrier tape width	W	W	$\frac{18}{(.709)}$	$\frac{-0.5/+1.0}{(-0.02/+0.039)}$
Hold down tape width	W_0	W_4	$\frac{11}{(.433)}$	min.
Hold down tape			No protrusion	
Top distance between tape edges	W_2	W_6	$\frac{3}{(.118)}$	max.
Sprocket hole position	W_1	W_5	$\frac{9}{(.354)}$	$\frac{-0.5/+0.75}{(-0.02/+0.03)}$
Sprocket hole diameter	D_0	D_0	$\frac{4}{(.157)}$	$\frac{\pm 0.2}{(\pm 0.079)}$
Abscissa to plane (MF-RM005/240~MF-RM016/240)	H	H	$\frac{18.5}{(.728)}$	$\frac{\pm 3.0}{(\pm .118)}$
Abscissa to plane (MF-RM025/240~MF-RM055/240)	H_0	H_0	$\frac{16}{(.63)}$	$\frac{\pm 0.5}{(\pm .02)}$
Abscissa to top (MF-RM005/240~MF-RM016/240)	H_1	H_1	$\frac{32.2}{(1.268)}$	max.
Abscissa to top (MF-RM025/240~MF-RM055/240)	H_1	H_1	$\frac{45.0}{(1.772)}$	max.
Overall width w/lead protrusion (MF-RM005/240~MF-RM016/240)		C_1	$\frac{43.2}{(1.701)}$	max.
Overall width w/lead protrusion (MF-RM025/240~MF-RM055/240)		C_1	$\frac{56.0}{(2.205)}$	max.
Overall width w/o lead protrusion (MF-RM005/240~MF-RM016/240)		C_2	$\frac{42.5}{(1.673)}$	max.
Overall width w/o lead protrusion (MF-RM025/240~MF-RM055/240)		C_2	$\frac{56.0}{(2.205)}$	max.
Lead protrusion	l_1	L_1	$\frac{1.0}{(.039)}$	max.
Protrusion of cutout	L	L	$\frac{11}{(.433)}$	max.
Protrusion beyond hold-down tape	l_2	l_2	Not specified	
Sprocket hole pitch	P_0	P_0	$\frac{12.7}{(.500)}$	$\frac{\pm 0.3}{(\pm .012)}$
Pitch tolerance			20 consecutive	$\frac{\pm 1}{(\pm .039)}$
Device pitch (MF-RM005/240-MF-RM040/240)			$\frac{12.7}{(.500)}$	$\frac{\pm 0.3}{(\pm .012)}$
Device pitch (MF-RM055/240)			$\frac{25.4}{(1.00)}$	$\frac{\pm 0.6}{(\pm .024)}$
Tape thickness	t	t	$\frac{0.9}{(.035)}$	max.
Tape thickness with splice (MF-RM005/240~MF-RM040/240)		t_1	$\frac{1.5}{(.059)}$	max.
Tape thickness with splice (MF-RM055/240)		t_1	$\frac{2.3}{(.091)}$	max.
Splice sprocket hole alignment			0	$\frac{\pm 0.3}{(\pm .012)}$
Body lateral deviation	Δ_h	Δ_h	0	$\frac{\pm 1}{(\pm .039)}$
Body tape plane deviation	Δ_p	Δ_p	0	$\frac{\pm 0.3}{(\pm .012)}$
Lead seating plane deviation	ΔP_1	P_1	$\frac{3.81}{(.015)}$	$\frac{\pm 0.7}{(\pm .028)}$
Lead spacing	F	F	$\frac{5.08}{(.200)}$	$\frac{+0.8/-0.5}{(+.031/-0.020)}$

DIMENSIONS: $\frac{\text{MM}}{\text{(INCHES)}}$

Specifications are subject to change without notice.
Customers should verify actual device performance in their specific applications.

MF-RM Series Tape and Reel Specifications

BOURNS®

Dimension Description	IEC Mark	EIA Mark	Dimensions	
			Dimensions	Tolerance
Reel width (MF-RM005/240~MF-RM040/240)	<i>w</i>	<i>w</i> ₂	$\frac{56.0}{(2.20)}$	max.
Reel width (MF-RM055/240)	<i>w</i>	<i>w</i> ₂	$\frac{63.5}{(2.50)}$	max.
Reel diameter	<i>d</i>	<i>a</i>	$\frac{370.0}{(14.57)}$	max.
Space between flanges (MF-RM005/240~MF-RM040/240)	<i>h</i>	<i>w</i> ₁	$\frac{48.0}{(1.89)}$	max.
Space between flanges (MF-RM055/240)	<i>h</i>	<i>w</i> ₁	$\frac{55.0}{(2.17)}$	max.
Arbor hole diameter	<i>f</i>	<i>c</i>	$\frac{26.0}{(1.02)}$	± 12.0 (± 4.72)
Core diameter	<i>h</i>	<i>n</i>	$\frac{91.0}{(3.58)}$	max.
Box			$\frac{64}{(2.5)}$ $\frac{372}{(14.6)}$ $\frac{372}{(14.6)}$	max.
Consecutive missing places			3	max.
Empty places per reel			0.1 %	max.

DIMENSIONS: $\frac{\text{MM}}{\text{(INCHES)}}$

Taped Component Dimensions - Figure 1

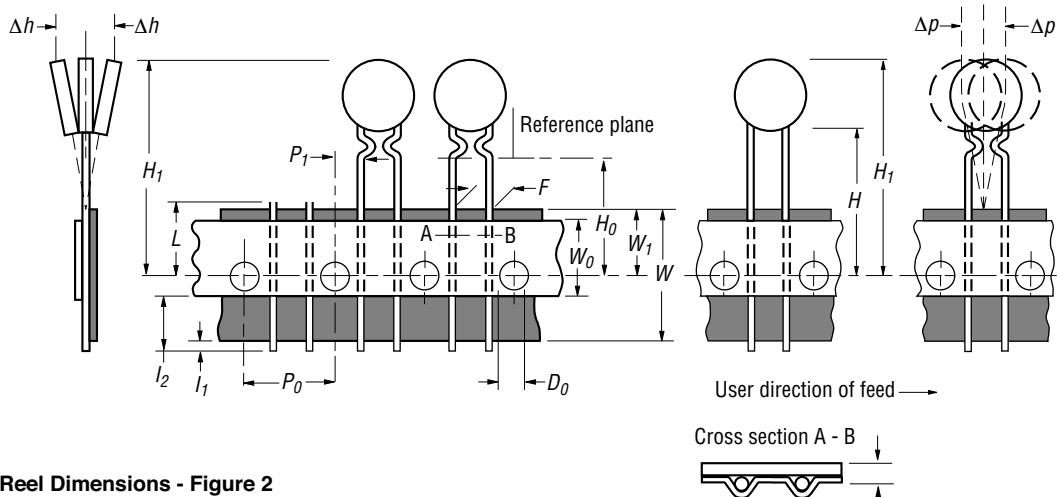

Reel Dimensions - Figure 2

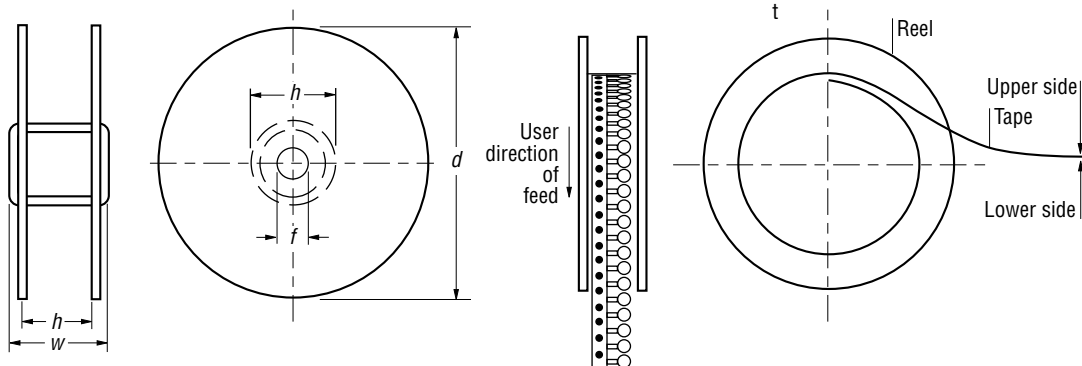

Specifications are subject to change without notice. Customers should verify actual device performance in their specific applications.



Стандарт Электрон Связь

Мы молодая и активно развивающаяся компания в области поставок электронных компонентов. Мы поставляем электронные компоненты отечественного и импортного производства напрямую от производителей и с крупнейших складов мира.

Благодаря сотрудничеству с мировыми поставщиками мы осуществляем комплексные и плановые поставки широчайшего спектра электронных компонентов.

Собственная эффективная логистика и склад в обеспечивает надежную поставку продукции в точно указанные сроки по всей России.

Мы осуществляем техническую поддержку нашим клиентам и предпродажную проверку качества продукции. На все поставляемые продукты мы предоставляем гарантию .

Осуществляем поставки продукции под контролем ВП МО РФ на предприятия военно-промышленного комплекса России , а также работаем в рамках 275 ФЗ с открытием отдельных счетов в уполномоченном банке. Система менеджмента качества компании соответствует требованиям ГОСТ ISO 9001.

Минимальные сроки поставки, гибкие цены, неограниченный ассортимент и индивидуальный подход к клиентам являются основой для выстраивания долгосрочного и эффективного сотрудничества с предприятиями радиоэлектронной промышленности, предприятиями ВПК и научно-исследовательскими институтами России.

С нами вы становитесь еще успешнее!

Наши контакты:

Телефон: +7 812 627 14 35

Электронная почта: sales@st-electron.ru

Адрес: 198099, Санкт-Петербург,
Промышленная ул, дом № 19, литера Н,
помещение 100-Н Офис 331