



Is Now Part of



**ON Semiconductor®**

To learn more about ON Semiconductor, please visit our website at  
[www.onsemi.com](http://www.onsemi.com)

Please note: As part of the Fairchild Semiconductor integration, some of the Fairchild orderable part numbers will need to change in order to meet ON Semiconductor's system requirements. Since the ON Semiconductor product management systems do not have the ability to manage part nomenclature that utilizes an underscore (\_), the underscore (\_) in the Fairchild part numbers will be changed to a dash (-). This document may contain device numbers with an underscore (\_). Please check the ON Semiconductor website to verify the updated device numbers. The most current and up-to-date ordering information can be found at [www.onsemi.com](http://www.onsemi.com). Please email any questions regarding the system integration to [Fairchild\\_questions@onsemi.com](mailto:Fairchild_questions@onsemi.com).

ON Semiconductor and the ON Semiconductor logo are trademarks of Semiconductor Components Industries, LLC dba ON Semiconductor or its subsidiaries in the United States and/or other countries. ON Semiconductor owns the rights to a number of patents, trademarks, copyrights, trade secrets, and other intellectual property. A listing of ON Semiconductor's product/patent coverage may be accessed at [www.onsemi.com/site/pdf/Patent-Marking.pdf](http://www.onsemi.com/site/pdf/Patent-Marking.pdf). ON Semiconductor reserves the right to make changes without further notice to any products herein. ON Semiconductor makes no warranty, representation or guarantee regarding the suitability of its products for any particular purpose, nor does ON Semiconductor assume any liability arising out of the application or use of any product or circuit, and specifically disclaims any and all liability, including without limitation special, consequential or incidental damages. Buyer is responsible for its products and applications using ON Semiconductor products, including compliance with all laws, regulations and safety requirements or standards, regardless of any support or applications information provided by ON Semiconductor. "Typical" parameters which may be provided in ON Semiconductor data sheets and/or specifications can and do vary in different applications and actual performance may vary over time. All operating parameters, including "Typicals" must be validated for each customer application by customer's technical experts. ON Semiconductor does not convey any license under its patent rights nor the rights of others. ON Semiconductor products are not designed, intended, or authorized for use as a critical component in life support systems or any FDA Class 3 medical devices or medical devices with a same or similar classification in a foreign jurisdiction or any devices intended for implantation in the human body. Should Buyer purchase or use ON Semiconductor products for any such unintended or unauthorized application, Buyer shall indemnify and hold ON Semiconductor and its officers, employees, subsidiaries, affiliates, and distributors harmless against all claims, costs, damages, and expenses, and reasonable attorney fees arising out of, directly or indirectly, any claim of personal injury or death associated with such unintended or unauthorized use, even if such claim alleges that ON Semiconductor was negligent regarding the design or manufacture of the part. ON Semiconductor is an Equal Opportunity/Affirmative Action Employer. This literature is subject to all applicable copyright laws and is not for resale in any manner.

# FODM8801A, FODM8801B, FODM8801C

## OptoHiT™ Series, High-Temperature Phototransistor Optocoupler in Half-Pitch Mini-Flat 4-Pin Package

### Features

- Utilizing Proprietary Process Technology to Achieve High Operating Temperature: up to 125°C
- Guaranteed Current Transfer Ratio (CTR) Specifications Across Full Temperature Range
  - Excellent CTR Linearity at High-Temperature
  - CTR at Very Low Input Current,  $I_F$
- High Isolation Voltage Regulated by Safety Agency: C-UL / UL1577, 3750 VAC<sub>RMS</sub> for 1 minute and DIN EN/IEC60747-5-5
- Compact Half-Pitch, Mini-Flat, 4-Pin Package (1.27 mm Lead Pitch, 2.4 mm Maximum Standoff Height)
- > 5 mm Creepage and Clearance Distance
- Applicable to Infrared Ray Reflow, 245°C

### Applications

- Primarily Suited for DC-DC Converters
- Ground-Loop Isolation, Signal-Noise Isolation
- Communications – Adapters, Chargers
- Consumer – Appliances, Set-Top Boxes
- Industrial – Power Supplies, Motor Control, Programmable Logic Control

### Description

In the OptoHiT™ series, the FODM8801 is a first-of-kind phototransistor, utilizing Fairchild's leading-edge proprietary process technology to achieve high operating temperature characteristics, up to 125°C. The optocoupler consists of an aluminum gallium arsenide (AlGaAs) infrared light-emitting diode (LED) optically coupled to a phototransistor, available in a compact half-pitch, mini-flat, 4-pin package. It delivers high current transfer ratio at very low input current. The input-output isolation voltage,  $V_{ISO}$ , is rated at 3750 VAC<sub>RMS</sub>.

### Schematic

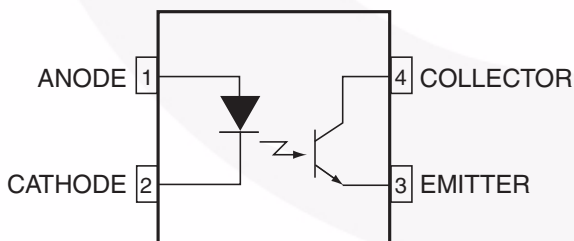


Figure 1. Schematic

### Package

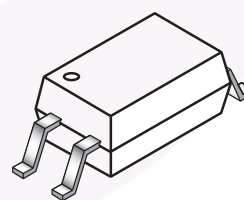


Figure 2. Half-Pitch Mini-Flat

## Safety and Insulation Ratings

As per DIN EN/IEC 60747-5-5, this optocoupler is suitable for “safe electrical insulation” only within the safety limit data. Compliance with the safety ratings shall be ensured by means of protective circuits.

Parameter		Characteristics
Installation Classifications per DIN VDE 0110/1.89 Table 1, For Rated Mains Voltage	< 150 V <sub>RMS</sub>	I–IV
	< 300 V <sub>RMS</sub>	I–III
Climatic Classification		40/125/21
Pollution Degree (DIN VDE 0110/1.89)		2
Comparative Tracking Index		175

Symbol	Parameter	Value	Unit
V <sub>PR</sub>	Input-to-Output Test Voltage, Method A, V <sub>IORM</sub> × 1.6 = V <sub>PR</sub> , Type and Sample Test with t <sub>m</sub> = 10 s, Partial Discharge < 5 pC	848	V <sub>peak</sub>
	Input-to-Output Test Voltage, Method B, V <sub>IORM</sub> × 1.875 = V <sub>PR</sub> , 100% Production Test with t <sub>m</sub> = 1 s, Partial Discharge < 5 pC	1060	V <sub>peak</sub>
V <sub>IORM</sub>	Maximum Working Insulation Voltage	565	V <sub>peak</sub>
V <sub>IOTM</sub>	Highest Allowable Over-Voltage	6000	V <sub>peak</sub>
	External Creepage	≥ 5	mm
	External Clearance	≥ 5	mm
DTI	Distance Through Insulation (Insulation Thickness)	≥ 0.5	mm
T <sub>S</sub>	Case Temperature <sup>(1)</sup>	150	°C
I <sub>S,INPUT</sub>	Input Current <sup>(1)</sup>	200	mA
P <sub>S,OUTPUT</sub>	Output Power <sup>(1)</sup>	300	mW
R <sub>IO</sub>	Insulation Resistance at T <sub>S</sub> , V <sub>IO</sub> = 500 V <sup>(1)</sup>	> 10 <sup>9</sup>	Ω

### Note:

1. Safety limit values – maximum values allowed in the event of a failure.

## Absolute Maximum Ratings

Stresses exceeding the absolute maximum ratings may damage the device. The device may not function or be operable above the recommended operating conditions and stressing the parts to these levels is not recommended. In addition, extended exposure to stresses above the recommended operating conditions may affect device reliability. The absolute maximum ratings are stress ratings only.  $T_A = 25^\circ\text{C}$  unless otherwise specified.

Symbol	Parameter	Value	Unit
<b>Total Package</b>			
$T_{\text{STG}}$	Storage Temperature	-40 to +150	$^\circ\text{C}$
$T_{\text{OPR}}$	Operating Temperature	-40 to +125	$^\circ\text{C}$
$T_J$	Junction Temperature	-40 to +140	$^\circ\text{C}$
$T_{\text{SOL}}$	Lead Solder Temperature	245 for 10 s	$^\circ\text{C}$
<b>Emitter</b>			
$I_{\text{F(average)}}$	Continuous Forward Current	20	mA
$V_R$	Reverse Input Voltage	6	V
$\text{PD}_{\text{LED}}$	Power Dissipation <sup>(2)(4)</sup>	40	mW
<b>Detector</b>			
$I_{\text{C(average)}}$	Continuous Collector Current	30	mA
$V_{\text{CEO}}$	Collector-Emitter Voltage	75	V
$V_{\text{ECO}}$	Emitter-Collector Voltage	7	V
$\text{PD}_{\text{C}}$	Collector Power Dissipation <sup>(3)(4)</sup>	150	mW

### Notes:

- Derate linearly from  $73^\circ\text{C}$  at a rate of  $0.24 \text{ mW}/^\circ\text{C}$
- Derate linearly from  $73^\circ\text{C}$  at a rate of  $2.23 \text{ mW}/^\circ\text{C}$ .
- Functional operation under these conditions is not implied. Permanent damage may occur if the device is subjected to conditions outside these ratings.

## Recommended Operating Conditions

The Recommended Operating Conditions table defines the conditions for actual device operation. Recommended operating conditions are specified to ensure optimal performance to the datasheet specifications. Fairchild does not recommend exceeding them or designing to absolute maximum ratings.

Symbol	Parameter	Value	Unit
$T_A$	Operating Temperature	-40 to +125	$^\circ\text{C}$
$V_{\text{FL(OFF)}}$	Input Low Voltage	-5.0 to +0.8	V
$I_{\text{FH}}$	Input High Forward Current	1 to 10	mA

## Isolation Characteristics

Symbol	Parameter	Conditions	Min.	Typ.	Max.	Unit
$V_{\text{ISO}}$	Input-Output Isolation Voltage	$f = 60 \text{ Hz}$ , $t = 1 \text{ min.}$ , $I_{\text{I-O}} \leq 10 \mu\text{A}$ <sup>(5)(6)</sup>	3,750			$\text{VAC}_{\text{RMS}}$
$R_{\text{ISO}}$	Isolation Resistance	$V_{\text{I-O}} = 500 \text{ V}$ <sup>(5)</sup>	$10^{12}$			$\Omega$
$C_{\text{ISO}}$	Isolation Capacitance	$f = 1 \text{ MHz}$		0.3	0.5	pF

### Notes:

- Device is considered a two-terminal device: pins 1 and 2 are shorted together and pins 3 and 4 are shorted together.
- $3,750 \text{ VAC}_{\text{RMS}}$  for 1 minute is equivalent to  $4,500 \text{ VAC}_{\text{RMS}}$  for 1 second.

## Electrical Characteristics

Apply over all recommended conditions ( $T_A = -40^\circ\text{C}$  to  $+125^\circ\text{C}$  unless otherwise specified).  
All typical values are measured at  $T_A = 25^\circ\text{C}$ .

Symbol	Parameter	Conditions	Min.	Typ.	Max.	Unit
<b>Emitter</b>						
$V_F$	Forward Voltage	$I_F = 1\text{ mA}$	1.00	1.35	1.80	V
$\Delta V_F / \Delta T_A$	Forward-Voltage Coefficient	$I_F = 1\text{ mA}$		-1.6		mV / $^\circ\text{C}$
$I_R$	Reverse Current	$V_R = 6\text{ V}$			10	$\mu\text{A}$
$C_T$	Terminal Capacitance	$V = 0\text{ V}$ , $f = 1\text{ MHz}$		30		pF
<b>Detector</b>						
$BV_{CEO}$	Collector-Emitter Breakdown Voltage	$I_C = 0.5\text{ mA}$ , $I_F = 0\text{ mA}$	75	130		V
$BV_{ECO}$	Emitter-Collector Breakdown Voltage	$I_E = 100\text{ }\mu\text{A}$ , $I_F = 0\text{ mA}$	7	12		V
$I_{CEO}$	Collector Dark Current	$V_{CE} = 75\text{ V}$ , $I_F = 0\text{ mA}$ , $T_A = 25^\circ\text{C}$			100	nA
		$V_{CE} = 50\text{ V}$ , $I_F = 0\text{ mA}$			50	$\mu\text{A}$
		$V_{CE} = 5\text{ V}$ , $I_F = 0\text{ mA}$			30	$\mu\text{A}$
$C_{CE}$	Capacitance	$V_{CE} = 0\text{ V}$ , $f = 1\text{ MHz}$		8		pF

### Transfer Characteristics

Apply over all recommended conditions ( $T_A = -40^\circ\text{C}$  to  $+125^\circ\text{C}$  unless otherwise specified).  
 All typical values are measured at  $T_A = 25^\circ\text{C}$ .

Symbol	Parameter	Device	Conditions	Min.	Typ.	Max.	Unit
CTR <sub>CE</sub>	Current Transfer Ratio (Collector-Emitter)	FODM8801A	$I_F = 1.0\text{ mA}, V_{CE} = 5\text{ V}$ @ $T_A = 25^\circ\text{C}$	80	120	160	%
			$I_F = 1.0\text{ mA}, V_{CE} = 5\text{ V}$	35	120	230	
			$I_F = 1.6\text{ mA}, V_{CE} = 5\text{ V}$	40	125		
			$I_F = 3.0\text{ mA}, V_{CE} = 5\text{ V}$	45	138		
		FODM8801B	$I_F = 1.0\text{ mA}, V_{CE} = 5\text{ V}$ @ $T_A = 25^\circ\text{C}$	130	195	260	
			$I_F = 1.0\text{ mA}, V_{CE} = 5\text{ V}$	65	195	360	
			$I_F = 1.6\text{ mA}, V_{CE} = 5\text{ V}$	70	202		
			$I_F = 3.0\text{ mA}, V_{CE} = 5\text{ V}$	75	215		
		FODM8801C	$I_F = 1.0\text{ mA}, V_{CE} = 5\text{ V}$ @ $T_A = 25^\circ\text{C}$	200	300	400	
			$I_F = 1.0\text{ mA}, V_{CE} = 5\text{ V}$	100	300	560	
			$I_F = 1.6\text{ mA}, V_{CE} = 5\text{ V}$	110	312		
			$I_F = 3.0\text{ mA}, V_{CE} = 5\text{ V}$	115	330		
CTR <sub>CE(SAT)</sub>	Saturated Current Transfer Ratio (Collector-Emitter)	FODM8801A	$I_F = 1.0\text{ mA}, V_{CE} = 0.4\text{ V}$ @ $T_A = 25^\circ\text{C}$	65	108	150	%
			$I_F = 1.0\text{ mA}, V_{CE} = 0.4\text{ V}$	30	108		
			$I_F = 1.6\text{ mA}, V_{CE} = 0.4\text{ V}$	25	104		
			$I_F = 3.0\text{ mA}, V_{CE} = 0.4\text{ V}$	20	92		
		FODM8801B	$I_F = 1.0\text{ mA}, V_{CE} = 0.4\text{ V}$ @ $T_A = 25^\circ\text{C}$	90	168	245	
			$I_F = 1.0\text{ mA}, V_{CE} = 0.4\text{ V}$	45	168		
			$I_F = 1.6\text{ mA}, V_{CE} = 0.4\text{ V}$	40	155		
			$I_F = 3.0\text{ mA}, V_{CE} = 0.4\text{ V}$	35	132		
		FODM8801C	$I_F = 1.0\text{ mA}, V_{CE} = 0.4\text{ V}$ @ $T_A = 25^\circ\text{C}$	140	238	380	
			$I_F = 1.0\text{ mA}, V_{CE} = 0.4\text{ V}$	75	238		
			$I_F = 1.6\text{ mA}, V_{CE} = 0.4\text{ V}$	65	215		
			$I_F = 3.0\text{ mA}, V_{CE} = 0.4\text{ V}$	55	177		
V <sub>CE(SAT)</sub>	Saturation Voltage	FODM8801A	$I_F = 1.0\text{ mA}, I_C = 0.3\text{ mA}$		0.17	0.40	V
			$I_F = 1.6\text{ mA}, I_C = 0.4\text{ mA}$		0.16	0.40	
			$I_F = 3.0\text{ mA}, I_C = 0.6\text{ mA}$		0.15	0.40	
		FODM8801B	$I_F = 1.0\text{ mA}, I_C = 0.45\text{ mA}$		0.17	0.40	
			$I_F = 1.6\text{ mA}, I_C = 0.6\text{ mA}$		0.16	0.40	
			$I_F = 3.0\text{ mA}, I_C = 1.0\text{ mA}$		0.16	0.40	
		FODM8801C	$I_F = 1.0\text{ mA}, I_C = 0.75\text{ mA}$		0.18	0.40	
			$I_F = 1.6\text{ mA}, I_C = 1.0\text{ mA}$		0.17	0.40	
			$I_F = 3.0\text{ mA}, I_C = 1.6\text{ mA}$		0.17	0.40	

## Switching Characteristics

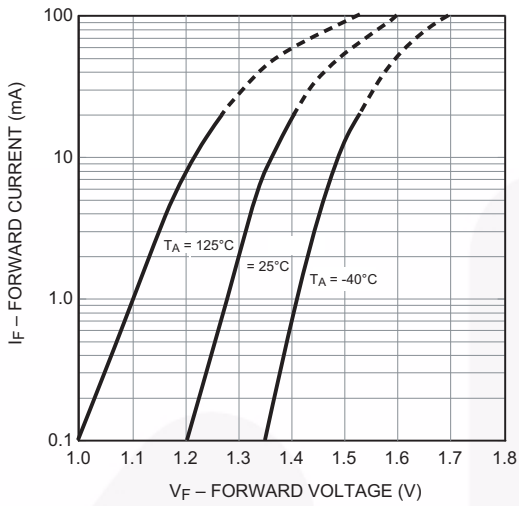
Apply over all recommended conditions ( $T_A = -40^\circ\text{C}$  to  $+125^\circ\text{C}$  unless otherwise specified).  
All typical values are measured at  $T_A = 25^\circ\text{C}$ .

Symbol	Parameter	Device	Conditions	Min.	Typ.	Max.	Unit
$t_{\text{ON}}$	Turn-On Time	All Devices	$I_F = 1.6 \text{ mA}$ , $V_{\text{CC}} = 5 \text{ V}$ , $R_L = 0.75 \text{ k}\Omega$	1	6	20	$\mu\text{s}$
			$I_F = 1.6 \text{ mA}$ , $V_{\text{CC}} = 5 \text{ V}$ , $R_L = 4.7 \text{ k}\Omega$		6		
$t_{\text{OFF}}$	Turn-Off Time	All Devices	$I_F = 1.6 \text{ mA}$ , $V_{\text{CC}} = 5 \text{ V}$ , $R_L = 0.75 \text{ k}\Omega$	1	6	20	$\mu\text{s}$
			$I_F = 1.6 \text{ mA}$ , $V_{\text{CC}} = 5 \text{ V}$ , $R_L = 4.7 \text{ k}\Omega$		40		
$t_R$	Output Rise Time (10% to 90%)	All Devices	$I_F = 1.6 \text{ mA}$ , $V_{\text{CC}} = 5 \text{ V}$ , $R_L = 0.75 \text{ k}\Omega$		5		$\mu\text{s}$
$t_F$	Output Fall Time (90% to 10%)	All Devices	$I_F = 1.6 \text{ mA}$ , $V_{\text{CC}} = 5 \text{ V}$ , $R_L = 0.75 \text{ k}\Omega$		5.5		$\mu\text{s}$
$\text{CM}_H$	Common-Mode Rejection Voltage (Transient Immunity) – Output High	All Devices	$T_A = 25^\circ\text{C}$ , $I_F = 0 \text{ mA}$ , $V_O > 2.0 \text{ V}$ , $R_L = 4.7 \text{ k}\Omega$ , $V_{\text{CM}} = 1000 \text{ V}^{(7)}$ , Figure 16		20		$\text{kV} / \mu\text{s}$
$\text{CM}_L$	Common-Mode Rejection Voltage (Transient Immunity) – Output Low	All Devices	$T_A = 25^\circ\text{C}$ , $I_F = 1.6 \text{ mA}$ , $V_O < 0.8 \text{ V}$ , $R_L = 4.7 \text{ k}\Omega$ , $V_{\text{CM}} = 1000 \text{ V}^{(7)}$ , Figure 16		20		$\text{kV} / \mu\text{s}$

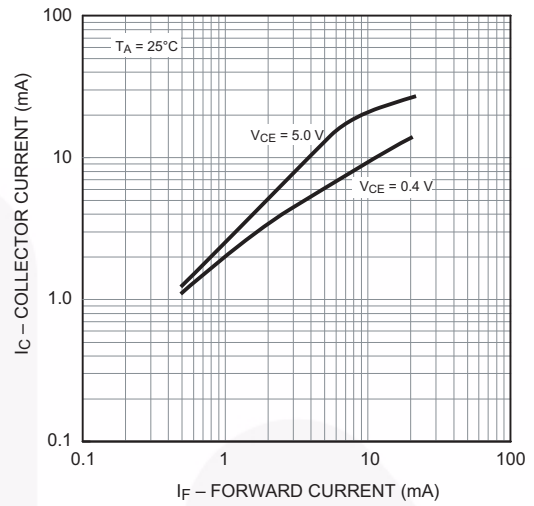
### Note:

7. Common-mode transient immunity at output high is the maximum tolerable positive  $dV_{\text{CM}}/dt$  on the leading edge of the common-mode impulse signal,  $V_{\text{CM}}$ , to assure that the output remains high.

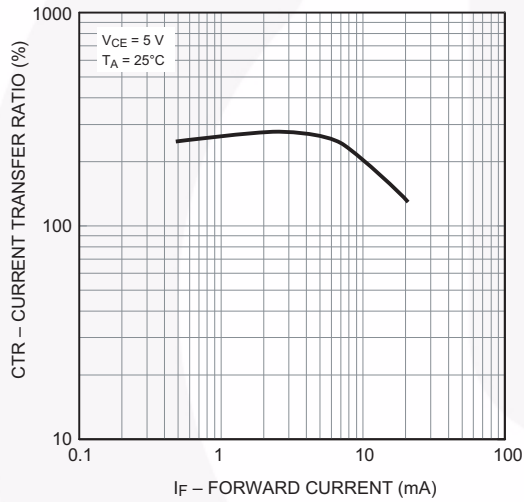
### Typical Performance Curves



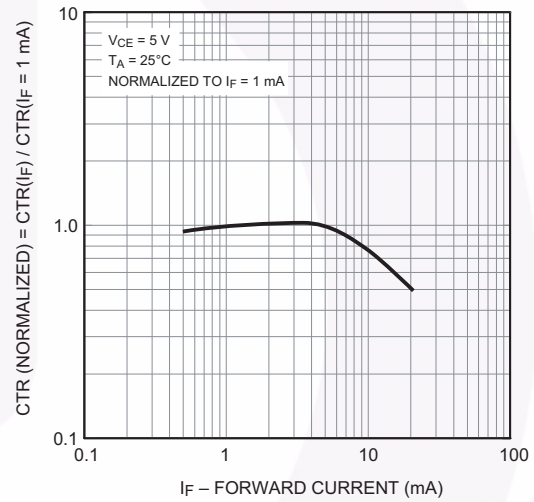
**Figure 3. Forward Current vs. Forward Voltage**



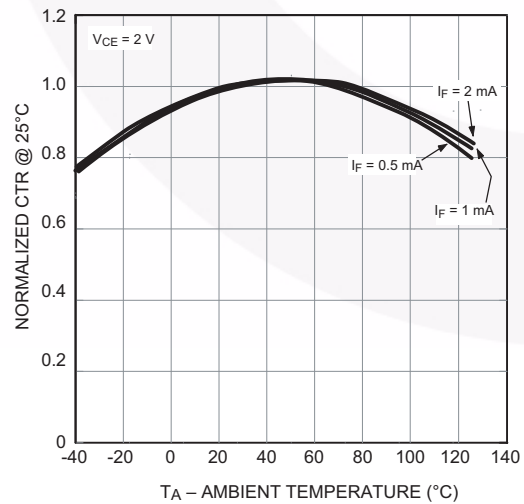
**Figure 4. Collector Current vs. Forward Current**



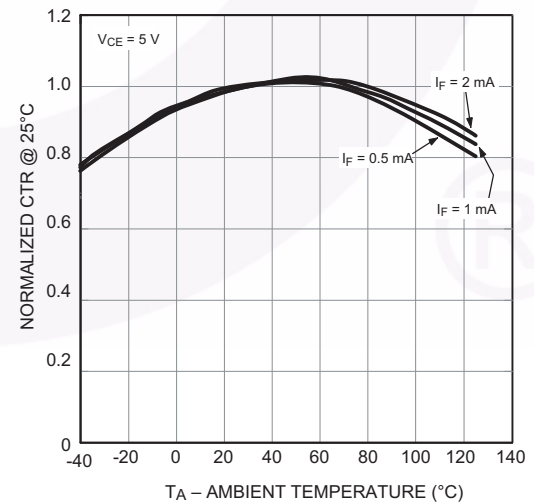
**Figure 5. Current Transfer Ratio vs. Forward Current**



**Figure 6. Normalized CTR vs. Forward Current**



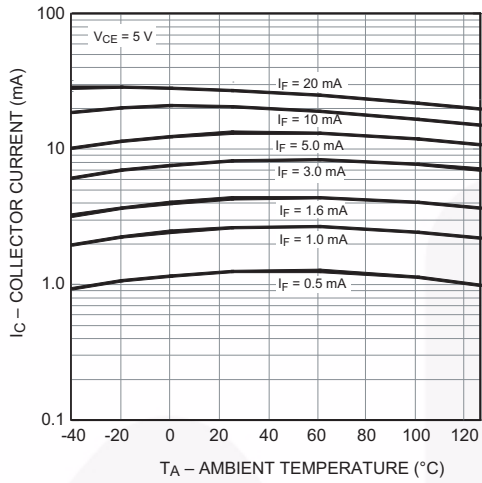
**Figure 7. Normalized CTR vs. Ambient Temperature**



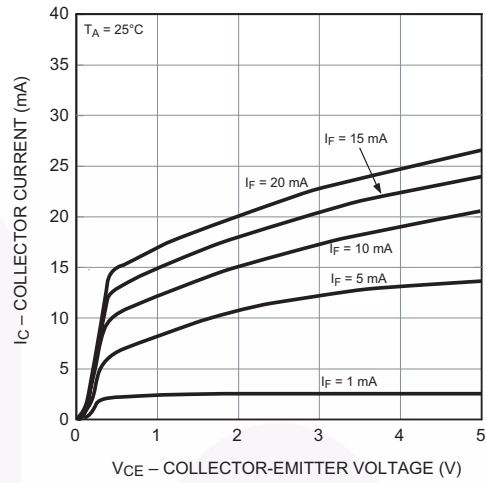
**Figure 8. Normalized CTR vs. Ambient Temperature**



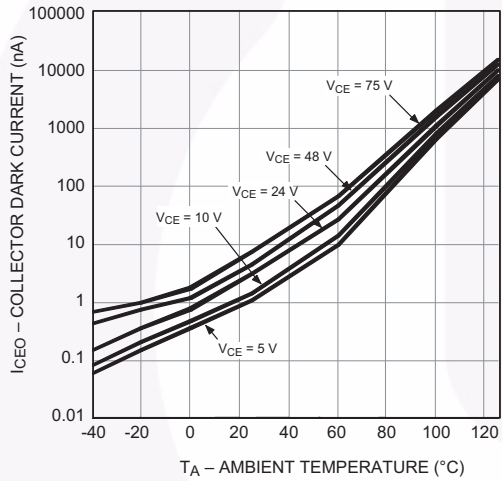
**Typical Performance Curves (Continued)**



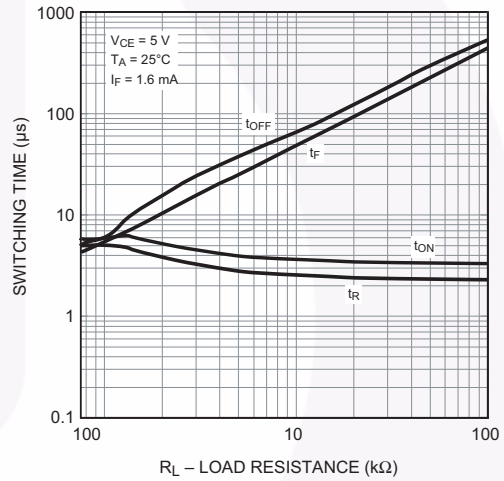
**Figure 9. Collector Current vs. Ambient Temperature**



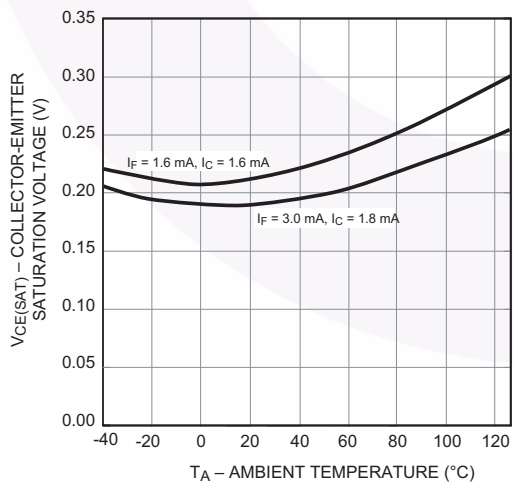
**Figure 10 Collector Current vs. Collector-Emitter Voltage**



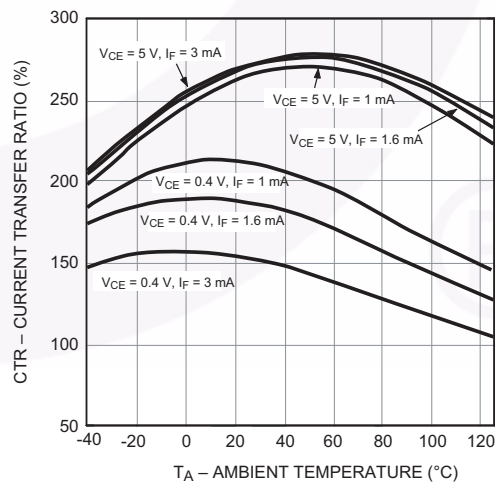
**Figure 11. Collector Dark Current vs. Ambient Temperature**



**Figure 12. Switching Time vs. Load Resistance**

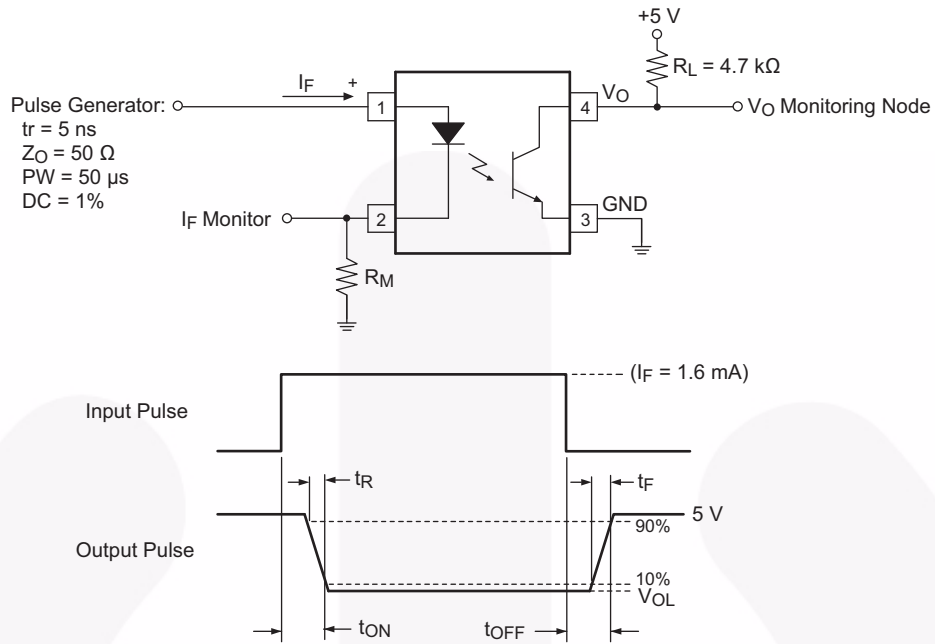


**Figure 13. Collector-Emitter Saturation Voltage vs. Ambient Temperature**

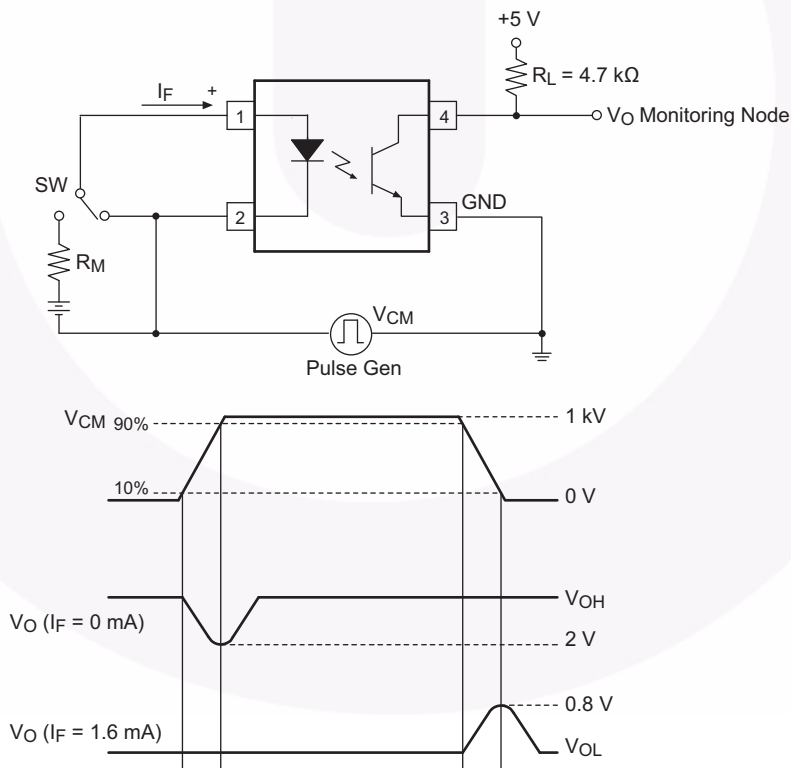


**Figure 14. Current Transfer Ratio vs. Ambient Temperature**

## Test Circuits



**Figure 15. Test Circuit for Propagation Delay, Rise Time, and Fall Time**



**Figure 16. Test Circuit for Instantaneous Common-Mode Rejection Voltage**

## Reflow Profile

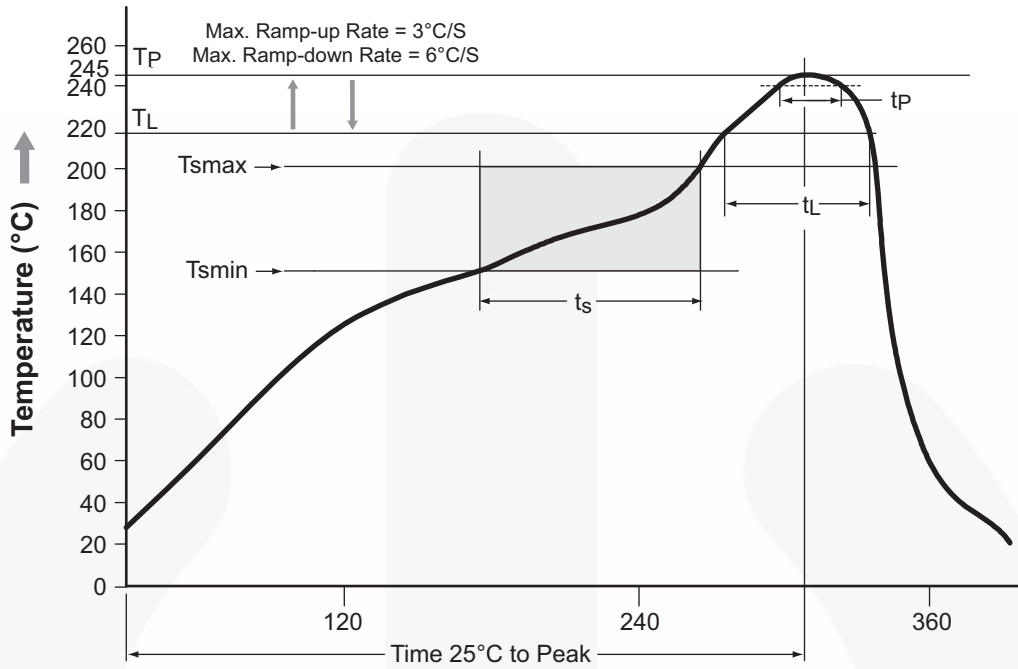


Figure 13. Reflow Profile

Profile Feature	Pb-Free Assembly Profile
Temperature Minimum (T <sub>smin</sub> )	150°C
Temperature Maximum (T <sub>smax</sub> )	200°C
Time (t <sub>s</sub> ) from (T <sub>smin</sub> to T <sub>smax</sub> )	60–120 seconds
Ramp-up Rate (t <sub>L</sub> to t <sub>P</sub> )	3°C/second maximum
Liquidous Temperature (T <sub>L</sub> )	217°C
Time (t <sub>L</sub> ) Maintained Above (T <sub>L</sub> )	60–150 seconds
Peak Body Package Temperature	245°C +0°C / –5°C
Time (t <sub>P</sub> ) within 5°C of 245°C	30 seconds
Ramp-down Rate (T <sub>P</sub> to T <sub>L</sub> )	6°C/second maximum
Time 25°C to Peak Temperature	8 minutes maximum

Figure 17. Reflow Profile

## Ordering Information

Part Number	Package	Packing Method
FODM8801A	Half Pitch Mini-Flat 4-Pin	Tube (100 units)
FODM8801AR2	Half Pitch Mini-Flat 4-Pin	Tape and Reel (2500 Units)
FODM8801AV	Half Pitch Mini-Flat 4-Pin, DIN EN/IEC60747-5-5 Option	Tube (100 Units)
FODM8801AR2V	Half Pitch Mini-Flat 4-Pin, DIN EN/IEC60747-5-5 Option	Tape and Reel (2500 Units)

**Note:**

8. The product orderable part number system listed in this table also applies to the FODM8801B, FODM8801C products.

## Marking Information

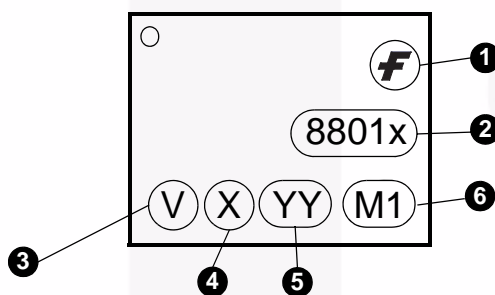
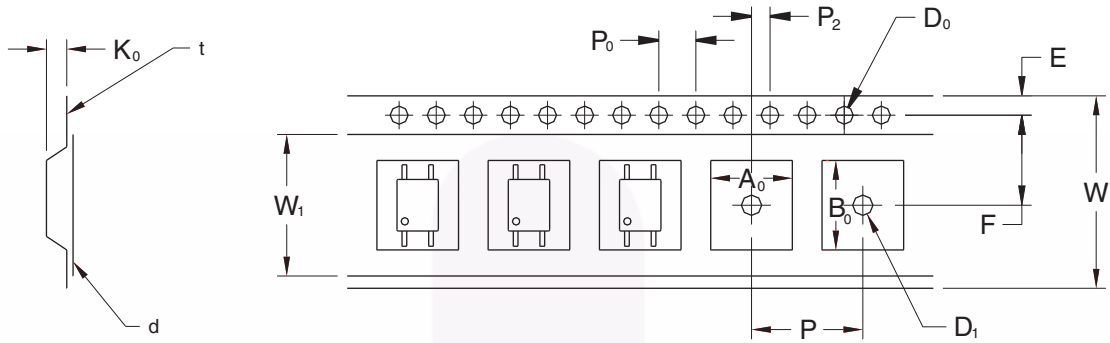


Figure 18. Top Mark

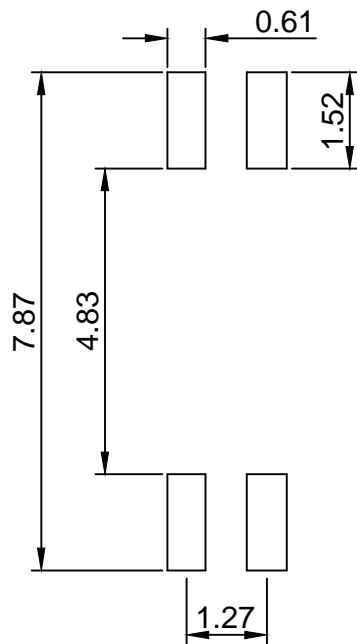
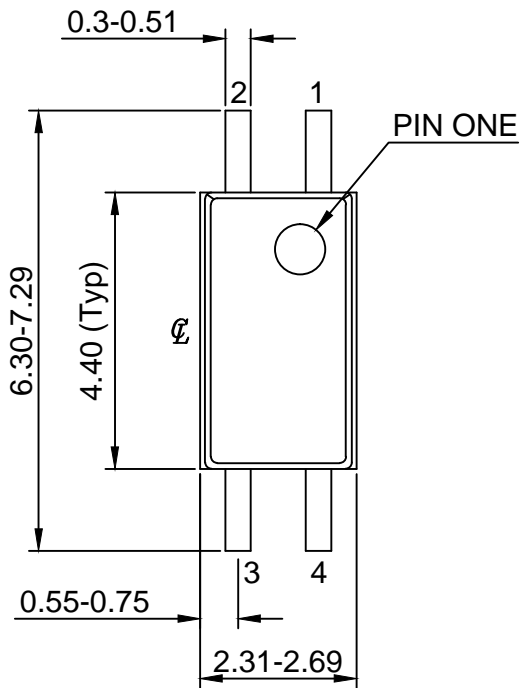
Table 1. Top Mark Definitions

1	Fairchild Logo
2	Device Number
3	DIN EN/IEC60747-5-5 Option (only appears on component ordered with this option)
4	One-Digit Year Code, e.g., “6”
5	Digit Work Week, Ranging from “01” to “53”
6	Assembly Package Code

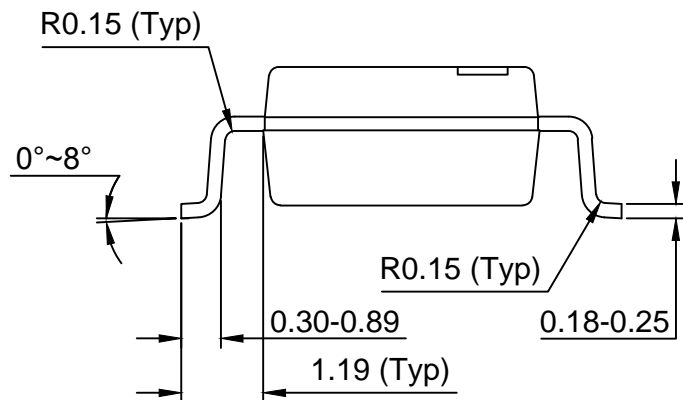
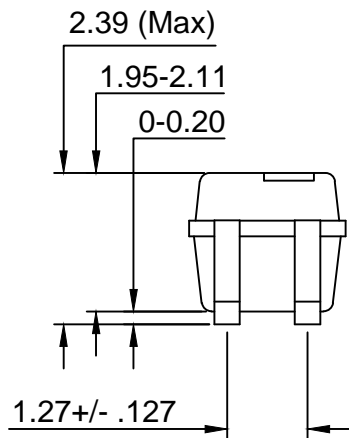
## Tape and Reel Dimensions



		1.27 Pitch
Description	Symbol	Dimensions (mm)
Tape Width	W	12.00 +0.30/-0.10
Tape Thickness	t	0.30 ±0.05
Sprocket Hole Pitch	P <sub>0</sub>	4.00 ±0.10
Sprocket Hole Diameter	D <sub>0</sub>	1.50 +0.10/-0.0
Sprocket Hole Location	E	1.75 ±0.10
Pocket Location	F	5.50 ±0.10
	P <sub>2</sub>	2.00 ±0.10
Pocket Pitch	P	8.00 ±0.10
Pocket Dimension	A <sub>0</sub>	2.80 ±0.10
	B <sub>0</sub>	7.30 ±0.10
	K <sub>0</sub>	2.30 ±0.10
Pocket Hole Diameter	D <sub>1</sub>	1.50 Min.
Cover Tape Width	W <sub>1</sub>	9.20
Cover Tape Thickness	d	0.065 ±0.010
Max. Component Rotation or Tilt		10° Max.
Devices Per Reel		2500
Reel Diameter		330 mm (13")



LAND PATTERN RECOMMENDATION



NOTES:

- A) NO STANDARD APPLIES TO THIS PACKAGE
- B) ALL DIMENSIONS ARE IN MILLIMETERS.
- C) DIMENSIONS ARE EXCLUSIVE OF BURRS, MOLD FLASH, AND TIE BAR EXTRUSION
- D) DRAWING FILENAME AND REVISION : MKT-MFP04AREV4.



ON Semiconductor and  are trademarks of Semiconductor Components Industries, LLC dba ON Semiconductor or its subsidiaries in the United States and/or other countries. ON Semiconductor owns the rights to a number of patents, trademarks, copyrights, trade secrets, and other intellectual property. A listing of ON Semiconductor's product/patent coverage may be accessed at [www.onsemi.com/site/pdf/Patent-Marking.pdf](http://www.onsemi.com/site/pdf/Patent-Marking.pdf). ON Semiconductor reserves the right to make changes without further notice to any products herein. ON Semiconductor makes no warranty, representation or guarantee regarding the suitability of its products for any particular purpose, nor does ON Semiconductor assume any liability arising out of the application or use of any product or circuit, and specifically disclaims any and all liability, including without limitation special, consequential or incidental damages. Buyer is responsible for its products and applications using ON Semiconductor products, including compliance with all laws, regulations and safety requirements or standards, regardless of any support or applications information provided by ON Semiconductor. "Typical" parameters which may be provided in ON Semiconductor data sheets and/or specifications can and do vary in different applications and actual performance may vary over time. All operating parameters, including "Typicals" must be validated for each customer application by customer's technical experts. ON Semiconductor does not convey any license under its patent rights nor the rights of others. ON Semiconductor products are not designed, intended, or authorized for use as a critical component in life support systems or any FDA Class 3 medical devices or medical devices with a same or similar classification in a foreign jurisdiction or any devices intended for implantation in the human body. Should Buyer purchase or use ON Semiconductor products for any such unintended or unauthorized application, Buyer shall indemnify and hold ON Semiconductor and its officers, employees, subsidiaries, affiliates, and distributors harmless against all claims, costs, damages, and expenses, and reasonable attorney fees arising out of, directly or indirectly, any claim of personal injury or death associated with such unintended or unauthorized use, even if such claim alleges that ON Semiconductor was negligent regarding the design or manufacture of the part. ON Semiconductor is an Equal Opportunity/Affirmative Action Employer. This literature is subject to all applicable copyright laws and is not for resale in any manner.

## PUBLICATION ORDERING INFORMATION

### LITERATURE FULFILLMENT:

Literature Distribution Center for ON Semiconductor  
19521 E. 32nd Pkwy, Aurora, Colorado 80011 USA  
**Phone:** 303-675-2175 or 800-344-3860 Toll Free USA/Canada  
**Fax:** 303-675-2176 or 800-344-3867 Toll Free USA/Canada  
**Email:** [orderlit@onsemi.com](mailto:orderlit@onsemi.com)

**N. American Technical Support:** 800-282-9855 Toll Free  
USA/Canada  
**Europe, Middle East and Africa Technical Support:**  
Phone: 421 33 790 2910  
**Japan Customer Focus Center**  
Phone: 81-3-5817-1050

**ON Semiconductor Website:** [www.onsemi.com](http://www.onsemi.com)  
**Order Literature:** <http://www.onsemi.com/orderlit>  
For additional information, please contact your local  
Sales Representative

# Mouser Electronics

Authorized Distributor

Click to View Pricing, Inventory, Delivery & Lifecycle Information:

[ON Semiconductor:](#)

[FODM8801C](#) [FODM8801CR2](#) [FODM8801CR2V](#) [FODM8801CV](#)





## Стандарт Электрон Связь

Мы молодая и активно развивающаяся компания в области поставок электронных компонентов. Мы поставляем электронные компоненты отечественного и импортного производства напрямую от производителей и с крупнейших складов мира.

Благодаря сотрудничеству с мировыми поставщиками мы осуществляем комплексные и плановые поставки широчайшего спектра электронных компонентов.

Собственная эффективная логистика и склад в обеспечивает надежную поставку продукции в точно указанные сроки по всей России.

Мы осуществляем техническую поддержку нашим клиентам и предпродажную проверку качества продукции. На все поставляемые продукты мы предоставляем гарантию .

Осуществляем поставки продукции под контролем ВП МО РФ на предприятия военно-промышленного комплекса России , а также работаем в рамках 275 ФЗ с открытием отдельных счетов в уполномоченном банке. Система менеджмента качества компании соответствует требованиям ГОСТ ISO 9001.

Минимальные сроки поставки, гибкие цены, неограниченный ассортимент и индивидуальный подход к клиентам являются основой для выстраивания долгосрочного и эффективного сотрудничества с предприятиями радиоэлектронной промышленности, предприятиями ВПК и научно-исследовательскими институтами России.

С нами вы становитесь еще успешнее!

### Наши контакты:

**Телефон:** +7 812 627 14 35

**Электронная почта:** [sales@st-electron.ru](mailto:sales@st-electron.ru)

**Адрес:** 198099, Санкт-Петербург,  
Промышленная ул, дом № 19, литера Н,  
помещение 100-Н Офис 331