

## Overview

The KEMET Organic Capacitor (KO-CAP) is a solid electrolytic capacitor with a conductive polymer cathode capable of delivering very low ESR and improved capacitance retention at high frequencies. KO-CAP combines the low ESR of multilayer ceramic, the high capacitance of aluminum electrolytic and the volumetric efficiency of tantalum into a single surface mount package. Unlike liquid electrolyte-based capacitors, KO-CAP has a very long operational life and high ripple current capabilities.

## KOCAP Polymer Capacitors

The T521 High Voltage Polymer Electrolytic is designed for higher application voltages than the T520 KO-CAP. Developed for use on 12, 24, 28 and 48 volt DC voltage rails. The low ESR of the T521 provides high ripple current capability. KO-CAP's long-life reliability enables the T521 to be an ideal alternative to liquid-based electrolytic capacitors.

## Benefits

- Low ESR
- Volumetrically efficient
- Stable temperature characteristics
- High ripple current capability
- High reliability
- 100% surge current tested
- Low profile design
- Halogen-Free Epoxy/RoHS Compliant

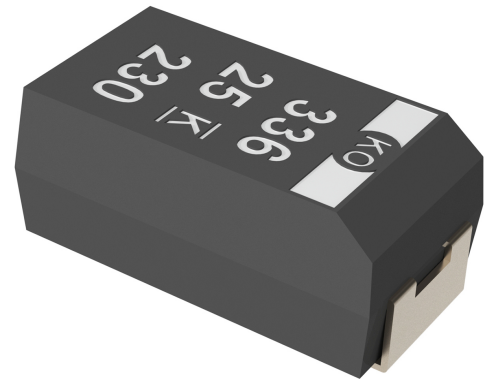

## Applications

Typical applications include DC/DC converters, power supply input and higher voltage applications such as 12 V to 50 V power input rails in the military/aerospace and industrial markets.

## Environmental Compliance

RoHS Compliant (6/6) according to Directive 2002/95/EC when ordered with 100% Sn solder.

## SPICE

For a detailed analysis of specific part numbers, please visit [www.kemet.com](http://www.kemet.com) for a free download of KEMET's SPICE software. The KEMET SPICE program is freeware intended to aid design engineers in analyzing the performance of these capacitors over frequency, temperature, ripple, and DC bias conditions.

## Ordering Information

| T               | 521                        | V                   | 226  | M                     | 025  | A                   | T  | E060  |                                    |
|-----------------|----------------------------|---------------------|--|-----------------------|--|---------------------|--|---|------------------------------------|
| Capacitor Class | Series                     | Case Size           | Capacitance Code (pF)  | Capacitance Tolerance | Rated Voltage (VDC)  | Failure Rate/Design | Termination Finish   | ESR Code  | Packaging (C-Spec)                 |
| T = Tantalum    | 521 = High Voltage Polymer | B, T, D, Q, V, W, X | First two digits represent significant figures. Third digit specifies number of zeros. | M = ±20%              | 016 = 16<br>020 = 20<br>025 = 25<br>035 = 35<br>050 = 50<br>063 = 63 | A = N/A             | T = 100% Matte Tin (Sn) plated<br>H = Tin/Lead (SnPb) solder coated (5% Pb minimum)<br>P = Ni/Pd/Au plated | E = ESR<br>Last three digits specify ESR in mΩ. (060 = 60 mΩ) | Blank = 7" Reel<br>7280 = 13" Reel |

## Performance Characteristics

| Item                    | Performance Characteristics  |
|-------------------------|--|
| Operating Temperature   | -55°C to 105°C/125°C (Refer to part number for maximum temperature rating) |
| Rated Capacitance Range | 4.7 – 330 µF at 120 Hz/25°C  |
| Capacitance Tolerance   | M Tolerance (20%)  |
| Rated Voltage Range     | 16 – 63 V  |
| DF (120 Hz)             | ≤ 10% - Refer to Part Number Electrical Specification Table                |
| ESR (100 kHz)           | Refer to Part Number Electrical Specification Table                        |
| Leakage Current         | ≤ 0.1 CV (µA) at rated voltage after 5 minutes                             |

## Qualification

| Test                       | Condition   | Characteristics |                                   |         |             |          |
|----------------------------|---|-----------------|-----------------------------------|---------|-------------|----------|
| Endurance                  | 105°C at rated voltage, 2,000 hours<br>125°C at 2/3 rated voltage, 2,000 hours**  | Δ C/C           | Within -20%/+10% of initial value |         |             |          |
|                            |   | DF              | Within initial limits             |         |             |          |
|                            |   | DCL             | IL at 105°C, 2 x IL at 125°C      |         |             |          |
|                            |   | ESR             | 2 x Initial Limit                 |         |             |          |
| Storage Life               | 105°C at 0 volts, 2,000 hours<br>125°C at 0 voltage, 2,000 hours**  | Δ C/C           | Within -20%/+10% of initial value |         |             |          |
|                            |   | DF              | Within initial limits             |         |             |          |
|                            |   | DCL             | IL at 105°C, 2 x IL at 125°C      |         |             |          |
|                            |   | ESR             | 2 x Initial Limit                 |         |             |          |
| Humidity                   | 60° C, 90% RH, 500 hours, No Load   | Δ C/C           | Within -5%/+35% of initial value  |         |             |          |
|                            |   | DF              | Within initial limits             |         |             |          |
|                            |   | DCL             | Within 3.0 x initial limit        |         |             |          |
| Temperature Stability      | Extreme temperature exposure at a succession of continuous steps at +25°C, -55°C, +25°C, +85°C, +105°/125°C, +25°C      | +25°C           | -55°C                             | +85°C   | +105°/125°C |          |
|                            |   | Δ C/C           | IL*                               | ±20%    | ±20%        | ±30%     |
|                            |   | DF              | IL                                | IL      | 1.2 x IL    | 1.5 x IL |
| DCL                        |   | IL              | N/A                               | 10 x IL | 10 x IL     |          |
|                            |   | ESR             | Within initial limits             |         |             |          |
|                            |   | ESR             | Within initial limits             |         |             |          |
| Surge Voltage              | 105°C, 1.32 x rated voltage, 33 Ω Resistance, 1,000 cycles  | Δ C/C           | Within -20%/+10% of initial value |         |             |          |
|                            |   | DF              | Within initial limits             |         |             |          |
|                            |   | DCL             | Within initial limits             |         |             |          |
|                            |   | ESR             | Within initial limits             |         |             |          |
| Mechanical Shock/Vibration | MIL-STD-202, Method 213, Condition I, 100 G peak.<br>MIL-STD-202, Method 204, Condition D, 10 Hz to 2,000 Hz, 20 G peak | Δ C/C           | Within ±10% of initial value      |         |             |          |
|                            |   | DF              | Within initial limits             |         |             |          |
|                            |   | DCL             | Within initial limits             |         |             |          |

\*IL = Initial limit

\*\*Refer to part number specifications for individual temperature classification.

## Electrical Characteristics

ESR vs. Frequency

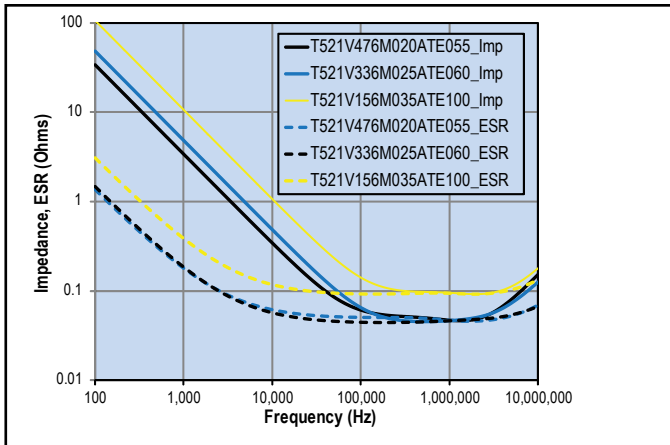

Capacitance vs. Frequency

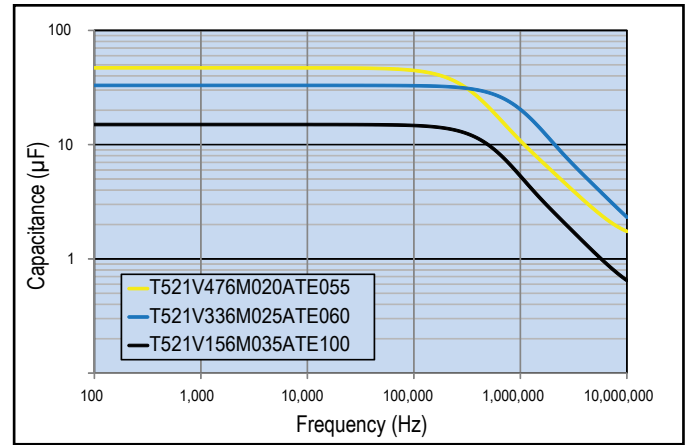

## Dimensions – Millimeters (Inches)

Metric will govern

CATHODE (-) END VIEW

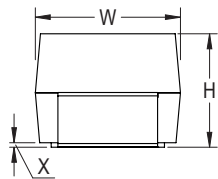

SIDE VIEW

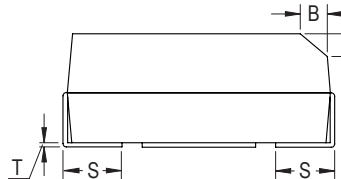

ANODE (+) END VIEW

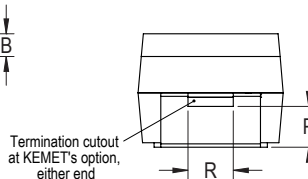

BOTTOM VIEW

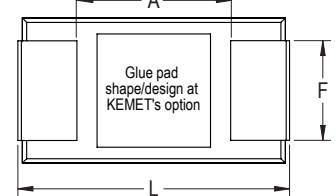

| Case Size |         | Component Dimensions       |                            |                            |                    |                    |                         |                              |             |             |              | Weight         |        |
|-----------|---------|----------------------------|----------------------------|----------------------------|--------------------|--------------------|-------------------------|------------------------------|-------------|-------------|--------------|----------------|--------|
| KEMET     | EIA     | L                          | W                          | H                          | F ±0.1<br>±(0.004) | S ±0.3<br>±(0.012) | B ±0.15 (Ref)<br>±0.006 | X (Ref)                      | P (Ref)     | R (Ref)     | T (Ref)      | A<br>(Minimum) | (mg)   |
| B         | 3528-21 | 3.5 ±0.2<br>(0.138 ±0.008) | 2.8 ±0.2<br>(0.110 ±0.008) | 1.9 ±0.1<br>(0.075 ±0.004) | 2.2 (0.087)        | 0.8 (0.031)        | 0.4 (0.016)             | 0.10 ±0.10<br>(0.004 ±0.004) | 0.5 (0.020) | 1.0 (0.039) | 0.13 (0.005) | 1.1 (0.043)    | 94.85  |
| T         | 3528-12 | 3.5 ±0.2<br>(0.138 ±0.008) | 2.8 ±0.2<br>(0.110 ±0.008) | 1.1 ±0.1<br>(0.043 ±0.004) | 2.2 (0.087)        | 0.8 (0.031)        | N/A                     | 0.05 (0.002)                 | N/A         | N/A         | 0.13 (0.005) | 1.1 (0.043)    | 54.84  |
| D         | 7343-31 | 7.3 ±0.3<br>(0.287 ±0.012) | 4.3 ±0.3<br>(0.169 ±0.012) | 2.8 ±0.3<br>(0.110 ±0.012) | 2.4 (0.094)        | 1.3 (0.051)        | 0.5 (0.020)             | 0.10 ±0.10<br>(0.004 ±0.004) | 0.9 (0.035) | 1.0 (0.039) | 0.13 (0.005) | 3.8 (0.150)    | 434.83 |
| Q         | 7343-12 | 7.3 ±0.3<br>(0.287 ±0.012) | 4.3 ±0.3<br>(0.169 ±0.012) | 1.1 ±0.1<br>(0.043 ±0.004) | 2.4 (0.094)        | 1.3 (0.051)        | N/A                     | 0.05 (0.002)                 | N/A         | N/A         | 0.13 (0.005) | 3.8 (0.150)    | 170.35 |
| V         | 7343-20 | 7.3 ±0.3<br>(0.287 ±0.012) | 4.3 ±0.3<br>(0.169 ±0.012) | 1.9 ±0.1<br>(0.075 ±0.004) | 2.4 (0.094)        | 1.3 (0.051)        | N/A                     | 0.05 (0.002)                 | N/A         | N/A         | 0.13 (0.005) | 3.8 (0.150)    | 274.30 |
| W         | 7343-15 | 7.3 ±0.3<br>(0.287 ±0.012) | 4.3 ±0.3<br>(0.169 ±0.012) | 1.4 ±0.1<br>(0.055 ±0.004) | 2.4 (0.094)        | 1.3 (0.051)        | N/A                     | 0.05 (0.002)                 | N/A         | N/A         | 0.13 (0.005) | 3.8 (0.150)    | 222.95 |
| X         | 7343-43 | 7.3 ±0.3<br>(0.287 ±0.012) | 4.3 ±0.3<br>(0.169 ±0.012) | 4.0 ±0.3<br>(0.157 ±0.012) | 2.4 (0.094)        | 1.3 (0.051)        | 0.5 (0.020)             | 0.10 ±0.10<br>(0.004 ±0.004) | 1.7 (0.067) | 1.0 (0.039) | 0.13 (0.005) | 3.8 (0.150)    | 553.96 |

Notes: (Ref) – Dimensions provided for reference only. For low profile cases, no dimensions are provided for B, P or R because these cases do not have a bevel or a notch.

**Table 1 – Ratings & Part Number Reference**

| Rated Voltage | Rated Capacitance | Case Code/<br>Case Size | KEMET Part Number            | DC Leakage           | DF                   | ESR                    | Maximum Allowable Ripple Current | MSL                 | Maximum Operating Temp |
|---------------|-------------------|-------------------------|------------------------------|----------------------|----------------------|------------------------|----------------------------------|---------------------|------------------------|
| VDC at 105°C  | µF                | KEMET/EIA               | (See below for part options) | µA at 25°C Max/5 Min | % at 25°C 120 Hz Max | mΩ at 25°C 100 kHz Max | mA at +45°C 100 kHz              | Reflow Temp ≤ 260°C | °C                     |
| 16            | 10                | B/3528-21               | T521B106M016A(1)E100         | 16.0                 | 8                    | 100                    | 1100.0                           | 3                   | 125                    |
| 16            | 15                | B/3528-21               | T521B156M016A(1)E090         | 24.0                 | 8                    | 90                     | 1200.0                           | 3                   | 105                    |
| 16            | 33                | Q/7343-12               | T521Q336M016A(1)E040         | 52.8                 | 10                   | 40                     | 2500.0                           | 3                   | 105                    |
| 16            | 33                | T/3528-12               | T521T336M016A(1)E050         | 52.8                 | 10                   | 50                     | 1400.0                           | 3                   | 105                    |
| 16            | 47                | W/7343-15               | T521W476M016A(1)E045         | 75.2                 | 10                   | 45                     | 2000.0                           | 3                   | 105                    |
| 16            | 47                | V/7343-20               | T521V476M016A(1)E070         | 75.2                 | 10                   | 70                     | 1600.0                           | 3                   | 105                    |
| 16            | 47                | V/7343-20               | T521V476M016A(1)E080         | 75.2                 | 10                   | 80                     | 1500.0                           | 3                   | 105                    |
| 16            | 47                | D/7343-31               | T521D476M016A(1)E045         | 75.2                 | 10                   | 45                     | 2200.0                           | 3                   | 105                    |
| 16            | 47                | D/7343-31               | T521D476M016A(1)E055         | 75.2                 | 10                   | 55                     | 2000.0                           | 3                   | 105                    |
| 16            | 47                | D/7343-31               | T521D476M016A(1)E070         | 75.2                 | 10                   | 70                     | 1800.0                           | 3                   | 105                    |
| 16            | 47                | D/7343-31               | T521D476M016A(1)E090         | 75.2                 | 10                   | 90                     | 1600.0                           | 3                   | 105                    |
| 16            | 68                | V/7343-20               | T521V686M016A(1)E050         | 108.8                | 10                   | 50                     | 1900.0                           | 3                   | 105                    |
| 16            | 68                | V/7343-20               | T521V686M016A(1)E090         | 108.8                | 10                   | 90                     | 1400.0                           | 3                   | 105                    |
| 16            | 100               | V/7343-20               | T521V107M016A(1)E050         | 160.0                | 10                   | 50                     | 1900.0                           | 3                   | 125                    |
| 16            | 100               | D/7343-31               | T521D107M016A(1)E050         | 160.0                | 10                   | 50                     | 2100.0                           | 3                   | 105                    |
| 16            | 150               | D/7343-31               | T521D157M016A(1)E050         | 240.0                | 10                   | 50                     | 2100.0                           | 3                   | 105                    |
| 16            | 150               | X/7343-43               | T521X157M016A(1)E080         | 240.0                | 10                   | 80                     | 1800.0                           | 3                   | 105                    |
| 16            | 220               | X/7343-43               | T521X227M016A(1)E035         | 352.0                | 10                   | 35                     | 2700.0                           | 3                   | 125                    |
| 16            | 220               | X/7343-43               | T521X227M016A(1)E050         | 352.0                | 10                   | 50                     | 2200.0                           | 3                   | 125                    |
| 16            | 330               | X/7343-43               | T521X337M016A(1)E025         | 528.0                | 10                   | 25                     | 3100.0                           | 3                   | 125                    |
| 16            | 330               | X/7343-43               | T521X337M016A(1)E050         | 528.0                | 10                   | 50                     | 2200.0                           | 3                   | 125                    |
| 20            | 10                | B/3528-21               | T521B106M020A(1)E100         | 20.0                 | 8                    | 100                    | 1100.0                           | 3                   | 105                    |
| 20            | 15                | B/3528-21               | T521B156M020A(1)E090         | 30.0                 | 10                   | 90                     | 1200.0                           | 3                   | 105                    |
| 20            | 22                | V/7343-20               | T521V226M020A(1)E090         | 44.0                 | 10                   | 90                     | 1400.0                           | 3                   | 125                    |
| 20            | 47                | W/7343-15               | T521W476M020A(1)E045         | 94.0                 | 9                    | 45                     | 2000.0                           | 3                   | 105                    |
| 20            | 47                | V/7343-20               | T521V476M020A(1)E090         | 94.0                 | 10                   | 90                     | 1400.0                           | 3                   | 125                    |
| 20            | 47                | V/7343-20               | T521V476M020A(1)E080         | 94.0                 | 10                   | 80                     | 1500.0                           | 3                   | 125                    |
| 20            | 47                | V/7343-20               | T521V476M020A(1)E055         | 94.0                 | 10                   | 55                     | 1800.0                           | 3                   | 125                    |
| 20            | 47                | D/7343-31               | T521D476M020A(1)E055         | 94.0                 | 10                   | 55                     | 2000.0                           | 3                   | 125                    |
| 20            | 100               | D/7343-31               | T521D107M020A(1)E055         | 200.0                | 10                   | 55                     | 2000.0                           | 3                   | 105                    |
| 25            | 10                | B/3528-21               | T521B106M025A(1)E100         | 25.0                 | 8                    | 100                    | 1100.0                           | 3                   | 105                    |
| 25            | 10                | T/3528-12               | T521T106M025A(1)E100         | 25.0                 | 8                    | 100                    | 1000.0                           | 3                   | 125                    |
| 25            | 10                | T/3528-12               | T521T106M025A(1)E060         | 25.0                 | 8                    | 60                     | 1300.0                           | 3                   | 125                    |
| 25            | 15                | V/7343-20               | T521V156M025A(1)E090         | 37.5                 | 10                   | 90                     | 1400.0                           | 3                   | 105                    |
| 25            | 22                | V/7343-20               | T521V226M025A(1)E045         | 55.0                 | 10                   | 45                     | 2000.0                           | 3                   | 105                    |
| 25            | 22                | V/7343-20               | T521V226M025A(1)E060         | 55.0                 | 10                   | 60                     | 1800.0                           | 3                   | 105                    |
| 25            | 22                | V/7343-20               | T521V226M025A(1)E090         | 55.0                 | 10                   | 90                     | 1400.0                           | 3                   | 105                    |
| 25            | 33                | V/7343-20               | T521V336M025A(1)E060         | 82.5                 | 10                   | 60                     | 1800.0                           | 3                   | 105                    |
| 25            | 33                | V/7343-20               | T521V336M025A(1)E040         | 82.5                 | 10                   | 40                     | 2200.0                           | 3                   | 105                    |
| 25            | 33                | D/7343-31               | T521D336M025A(1)E060         | 82.5                 | 10                   | 60                     | 1900.0                           | 3                   | 105                    |
| 25            | 100               | X/7343-43               | T521X107M025A(1)E060         | 250.0                | 10                   | 60                     | 2000.0                           | 3                   | 105                    |
| 35            | 6.8               | T/3528-12               | T521T685M035APE090           | 23.8                 | 10                   | 90                     | 1100.0                           | 3                   | 125                    |
| 35            | 10                | V/7343-20               | T521V106M035A(1)E120         | 35.0                 | 10                   | 120                    | 1200.0                           | 3                   | 125                    |
| 35            | 15                | V/7343-20               | T521V156M035A(1)E100         | 52.5                 | 10                   | 100                    | 1400.0                           | 3                   | 125                    |
| 35            | 15                | V/7343-20               | T521V156M035A(1)E125         | 52.5                 | 10                   | 125                    | 1200.0                           | 3                   | 125                    |
| 35            | 33                | D/7343-31               | T521D336M035A(1)E065         | 115.5                | 10                   | 65                     | 1900.0                           | 3                   | 125                    |
| VDC at 105°C  | µF                | KEMET/EIA               | (See below for part options) | µA at 25°C Max/5 Min | % at 25°C 120 Hz Max | mΩ at 25°C 100 kHz Max | mA at +45°C 100 kHz              | Reflow Temp ≤ 260°C | °C                     |
| Rated Voltage | Rated Capacitance | Case Code/<br>Case Size | KEMET Part Number            | DC Leakage           | DF                   | ESR                    | Maximum Allowable Ripple Current | MSL                 | Maximum Operating Temp |

Other part number options:

1- Standard with tin terminations (14th character = T). Tin/lead terminations is also available (14th character = H).

Also available on large (13 inch) reels. Add 7280 to the end of the part number.

Higher voltage ratings and tighter tolerance product including ESR may be substituted within the same size at KEMET's option. Voltage substitutions will be marked with the higher voltage rating. Substitutions can include better than series.

**Table 1 – Ratings & Part Number Reference cont'd**

| Rated Voltage | Rated Capacitance | Case Code/<br>Case Size | KEMET Part Number            | DC Leakage           | DF                   | ESR                    | Maximum Allowable Ripple Current | MSL                 | Maximum Operating Temp |
|---------------|-------------------|-------------------------|------------------------------|----------------------|----------------------|------------------------|----------------------------------|---------------------|------------------------|
| VDC at 105°C  | µF                | KEMET/EIA               | (See below for part options) | µA at 25°C Max/5 Min | % at 25°C 120 Hz Max | mΩ at 25°C 100 kHz Max | mA at +45°C 100 kHz              | Reflow Temp ≤ 260°C | °C                     |
| 35            | 47                | X/7343-43               | T521X476M035A(1)E030         | 164.5                | 10                   | 30                     | 2900.0                           | 3                   | 125                    |
| 35            | 47                | X/7343-43               | T521X476M035A(1)E070         | 164.5                | 10                   | 70                     | 1900.0                           | 3                   | 125                    |
| 50            | 5.6               | D/7343-31               | T521D565M050A(1)E070         | 28                   | 10                   | 70                     | 1800                             | 3                   | 125                    |
| 50            | 5.6               | D/7343-31               | T521D565M050A(1)E090         | 28                   | 10                   | 90                     | 1600                             | 3                   | 125                    |
| 50            | 5.6               | V/7343-20               | T521V565M050A(1)E070         | 28                   | 10                   | 70                     | 1800                             | 3                   | 125                    |
| 50            | 5.6               | V/7343-20               | T521V565M050A(1)E090         | 28                   | 10                   | 90                     | 1600                             | 3                   | 125                    |
| 50            | 6.8               | D/7343-31               | T521D685M050A(1)E070         | 34.0                 | 10                   | 70                     | 1800.0                           | 3                   | 125                    |
| 50            | 6.8               | D/7343-31               | T521D685M050A(1)E090         | 34.0                 | 10                   | 90                     | 1600.0                           | 3                   | 125                    |
| 50            | 6.8               | V/7343-20               | T521V685M050A(1)E070         | 34.0                 | 10                   | 70                     | 1800.0                           | 3                   | 125                    |
| 50            | 6.8               | V/7343-20               | T521V685M050A(1)E090         | 34.0                 | 10                   | 90                     | 1600.0                           | 3                   | 125                    |
| 50            | 10                | D/7343-31               | T521D106M050A(1)E090         | 50.0                 | 10                   | 90                     | 1600.0                           | 3                   | 125                    |
| 50            | 10                | D/7343-31               | T521D106M050A(1)E120         | 50.0                 | 10                   | 120                    | 1369.0                           | 3                   | 125                    |
| 50            | 10                | V/7343-20               | T521V106M050A(1)E090         | 50.0                 | 10                   | 90                     | 1600.0                           | 3                   | 125                    |
| 50            | 18                | D/7343-31               | T521D186M050A(1)E090         | 90.0                 | 10                   | 90                     | 1600.0                           | 3                   | 125                    |
| 50            | 18                | X/7343-43               | T521X186M050A(1)E070         | 90.0                 | 10                   | 70                     | 1900.0                           | 3                   | 125                    |
| 50            | 18                | X/7343-43               | T521X186M050A(1)E050         | 90.0                 | 10                   | 50                     | 2200.0                           | 3                   | 125                    |
| 50            | 22                | D/7343-31               | T521D226M050A(1)E090         | 110.0                | 10                   | 90                     | 1600.0                           | 3                   | 125                    |
| 50            | 22                | X/7343-43               | T521X226M050A(1)E075         | 110.0                | 10                   | 75                     | 1815.0                           | 3                   | 125                    |
| 50            | 22                | X/7343-43               | T521X226M050A(1)E050         | 110.0                | 10                   | 50                     | 2200.0                           | 3                   | 125                    |
| 50            | 33                | X/7343-43               | T521X336M050A(1)E075         | 165.0                | 10                   | 75                     | 1815.0                           | 3                   | 125                    |
| 50            | 33                | X/7343-43               | T521X336M050A(1)E050         | 165.0                | 10                   | 50                     | 2200.0                           | 3                   | 125                    |
| 63            | 4.7               | D/7343-31               | T521D475M063A(1)E300         | 29.6                 | 10                   | 300                    | 900.0                            | 3                   | 125                    |
| 63            | 4.7               | D/7343-31               | T521D475M063A(1)E075         | 29.6                 | 10                   | 75                     | 1700.0                           | 3                   | 125                    |
| 63            | 10                | X/7343-43               | T521X106M063A(1)E050         | 63.0                 | 10                   | 50                     | 2200.0                           | 3                   | 125                    |
| 63            | 15                | X/7343-43               | T521X156M063A(1)E035         | 94.5                 | 10                   | 35                     | 2600.0                           | 3                   | 125                    |
| 63            | 15                | X/7343-43               | T521X156M063A(1)E150         | 94.5                 | 10                   | 150                    | 1300.0                           | 3                   | 125                    |
| VDC at 105°C  | µF                | KEMET/EIA               | (See below for part options) | µA at 25°C Max/5 Min | % at 25°C 120 Hz Max | mΩ at 25°C 100 kHz Max | mA at +45°C 100 kHz              | Reflow Temp ≤ 260°C | °C                     |
| Rated Voltage | Rated Capacitance | Case Code/<br>Case Size | KEMET Part Number            | DC Leakage           | DF                   | ESR                    | Maximum Allowable Ripple Current | MSL                 | Maximum Operating Temp |

Other part number options:

1- Standard with tin terminations (14th character = T). Tin/lead terminations is also available (14th character = H).

Also available on large (13 inch) reels. Add 7280 to the end of the part number.

Higher voltage ratings and tighter tolerance product including ESR may be substituted within the same size at KEMET's option. Voltage substitutions will be marked with the higher voltage rating. Substitutions can include better than series.

## Derating Guidelines

| Voltage Rating                          | Maximum Recommended Steady State Voltage | Maximum Recommended Transient Voltage (1 ms – 1 μs) |
|---|--|---|
| -55°C to 105°C                          |  |   |
| $16\text{ V} \leq V_R \leq 63\text{ V}$ | 80% of $V_R$                             | $V_R$   |
| 105°C to 125°C                          |  |   |
| $16\text{ V} \leq V_R \leq 63\text{ V}$ | 54% of $V_R$                             | 67% of $V_R$  |

$V_R$  = Rated Voltage

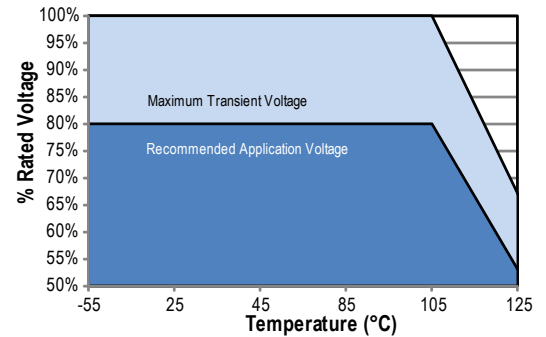

## Ripple Current/Ripple Voltage

Permissible AC ripple voltage and current are related to equivalent series resistance (ESR) and the power dissipation capabilities of the device. Permissible AC ripple voltage which may be applied is limited by two criteria:

1. The positive peak AC voltage plus the DC bias voltage, if any, must not exceed the DC voltage rating of the capacitor.
2. The negative peak AC voltage in combination with bias voltage, if any, must not exceed the allowable limits specified for reverse voltage. See the Reverse Voltage section for allowable limits.

The maximum power dissipation by case size can be determined using the table at right. The maximum power dissipation rating stated in the table must be reduced with increasing environmental operating temperatures. Refer to the table below for temperature compensation requirements.

| Case Code | EIA Case Code | Maximum Power Dissipation (P max) mWatts at 45°C with +30°C Rise |
|-----------|---------------|--|
| T         | 3528-12       | 105  |
| B         | 3528-21       | 127  |
| W         | 7343-15       | 180  |
| V         | 7343-20       | 187  |
| D         | 7343-31       | 225  |
| Q         | 7343-12       | 170  |
| X         | 7343-43       | 247  |

The maximum power dissipation rating must be reduced with increasing environmental operating temperatures. Refer to the Temperature Compensation Multiplier table for details.

| Temperature Compensation Multipliers for Maximum Ripple Current |  |   |
|---|--|---|
| $T \leq 45^\circ\text{C}$                                       | $45^\circ\text{C} < T \leq 85^\circ\text{C}$ | $85^\circ\text{C} < T \leq 125^\circ\text{C}$ |
| 1.00  | 0.70   | 0.25  |

$T$  = Environmental Temperature

Using the P max of the device, the maximum allowable rms ripple current or voltage may be determined.

$$I(\text{max}) = \sqrt{P \text{ max}/R}$$

$$E(\text{max}) = Z \sqrt{P \text{ max}/R}$$

$I$  = rms ripple current (amperes)  
 $E$  = rms ripple voltage (volts)  
 $P \text{ max}$  = maximum power dissipation (watts)  
 $R$  = ESR at specified frequency (ohms)  
 $Z$  = Impedance at specified frequency (ohms)

## Reverse Voltage

Polymer electrolytic capacitors are polar devices and may be permanently damaged or destroyed if connected in the wrong polarity. These devices will withstand a small degree of transient voltage reversal for short periods as shown in the below table.

| Temperature | Permissible Transient Reverse Voltage |
|-------------|---------------------------------------|
| 25°C        | 15% of Rated Voltage                  |
| 55°C        | 10% of Rated Voltage                  |
| 85°C        | 5% of Rated Voltage                   |
| 105°C       | 3% of Rated Voltage                   |
| 125°C*      | 1% of Rated Voltage                   |

\*For series rated to 125°C

### Table 2 – Land Dimensions/Courtyard

| KEMET          | Metric Size Code | Density Level A:<br>Maximum (Most) Land Protrusion (mm) |      |      |       |      | Density Level B:<br>Median (Nominal) Land Protrusion (mm) |      |      |      |      | Density Level C:<br>Minimum (Least) Land Protrusion (mm) |      |      |      |      |
|----------------|------------------|---|------|------|-------|------|---|------|------|------|------|--|------|------|------|------|
|                |                  | W   | L    | S    | V1    | V2   | W   | L    | S    | V1   | V2   | W  | L    | S    | V1   | V2   |
| B              | 3528-21          | 2.35  | 2.21 | 0.92 | 6.32  | 4.00 | 2.23  | 1.80 | 1.12 | 5.22 | 3.50 | 2.13   | 1.42 | 1.28 | 4.36 | 3.24 |
| D              | 7343-31          | 2.55  | 2.77 | 3.67 | 10.22 | 5.60 | 2.43  | 2.37 | 3.87 | 9.12 | 5.10 | 2.33   | 1.99 | 4.03 | 8.26 | 4.84 |
| Q              | 7343-12          | 2.55  | 2.77 | 3.67 | 10.22 | 5.60 | 2.43  | 2.37 | 3.87 | 9.12 | 5.10 | 2.33   | 1.99 | 4.03 | 8.26 | 4.84 |
| T              | 3528-12          | 2.35  | 2.20 | 0.92 | 6.32  | 4.00 | 2.23  | 1.80 | 1.12 | 5.22 | 3.50 | 2.13   | 1.42 | 1.28 | 4.36 | 3.24 |
| V              | 7343-20          | 2.55  | 2.77 | 3.67 | 10.22 | 5.60 | 2.43  | 2.37 | 3.87 | 9.12 | 5.10 | 2.33   | 1.99 | 4.03 | 8.26 | 4.84 |
| W              | 7343-15          | 2.55  | 2.77 | 3.67 | 10.22 | 5.60 | 2.43  | 2.37 | 3.87 | 9.12 | 5.10 | 2.33   | 1.99 | 4.03 | 8.26 | 4.84 |
| X <sup>1</sup> | 7343-43          | 2.55  | 2.77 | 3.67 | 10.22 | 5.60 | 2.43  | 2.37 | 3.87 | 9.12 | 5.10 | 2.33   | 1.99 | 4.03 | 8.26 | 4.84 |

**Density Level A:** For low-density product applications. Recommended for wave solder applications and provides a wider process window for reflow solder processes.

**Density Level B:** For products with a moderate level of component density. Provides a robust solder attachment condition for reflow solder processes.

**Density Level C:** For high component density product applications. Before adapting the minimum land pattern variations the user should perform qualification testing based on the conditions outlined in IPC standard 7351 (IPC-7351).

<sup>1</sup> Height of these chips may create problems in wave soldering.

<sup>2</sup> Land pattern geometry is too small for silkscreen outline.

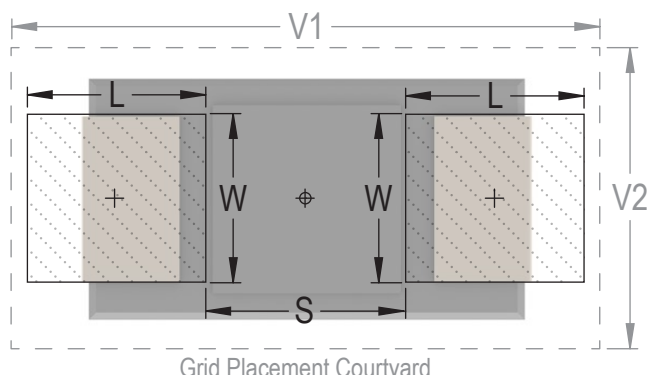



## Soldering Process

KEMET's families of surface mount capacitors are compatible with wave (single or dual), convection, IR, or vapor phase reflow techniques. Preheating of these components is recommended to avoid extreme thermal stress. KEMET's recommended profile conditions for convection and IR reflow reflect the profile conditions of the IPC/J-STD-020D standard for moisture sensitivity testing. The devices can safely withstand a maximum of three reflow passes at these conditions.

Please note that although the X/7343-43 case size can withstand wave soldering, the tall profile (4.3 mm maximum) dictates care in wave process development.

Hand soldering should be performed with care due to the difficulty in process control. If performed, care should be taken to avoid contact of the soldering iron to the molded case. The iron should be used to heat the solder pad, applying solder between the pad and the termination, until reflow occurs. Once reflow occurs, the iron should be removed immediately. "Wiping" the edges of a chip and heating the top surface is not recommended.

| Profile Feature                                       | SnPb Assembly       | Pb-Free Assembly    |
|---|---------------------|---------------------|
| <b>Preheat/Soak</b>                                   |                     |                     |
| Temperature Minimum ( $T_{smin}$ )                    | 100°C               | 150°C               |
| Temperature Maximum ( $T_{smax}$ )                    | 150°C               | 200°C               |
| Time ( $t_s$ ) from $T_{smin}$ to $T_{smax}$          | 60 – 120 seconds    | 60 – 120 seconds    |
| Ramp-up Rate ( $T_L$ to $T_p$ )                       | 3°C/seconds maximum | 3°C/seconds maximum |
| Liquidous Temperature ( $T_L$ )                       | 183°C               | 217°C               |
| Time Above Liquidous ( $t_L$ )                        | 60 – 150 seconds    | 60 – 150 seconds    |
| Peak Temperature ( $T_p$ )                            | 220°C*<br>235°C**   | 250°C*<br>260°C**   |
| Time within 5°C of Maximum Peak Temperature ( $t_p$ ) | 20 seconds maximum  | 30 seconds maximum  |
| Ramp-down Rate ( $T_p$ to $T_L$ )                     | 6°C/seconds maximum | 6°C/seconds maximum |
| Time 25°C to Peak Temperature                         | 6 minutes maximum   | 8 minutes maximum   |

Note: All temperatures refer to the center of the package, measured on the package body surface that is facing up during assembly reflow.

\*Case Size D, E, P, Y, and X

\*\*Case Size A, B, C, H, I, K, M, R, S, T, U, V, W, and Z



## Storage

All KO-CAP series are shipped in moisture barrier bags with a desiccant and moisture indicator card. These series are classified as MSL3 (Moisture Sensitivity Level 3). Product contained within the moisture barrier bags should be stored in normal working environments with temperatures not to exceed 40°C and humidity not in excess of 90% RH.

## Construction

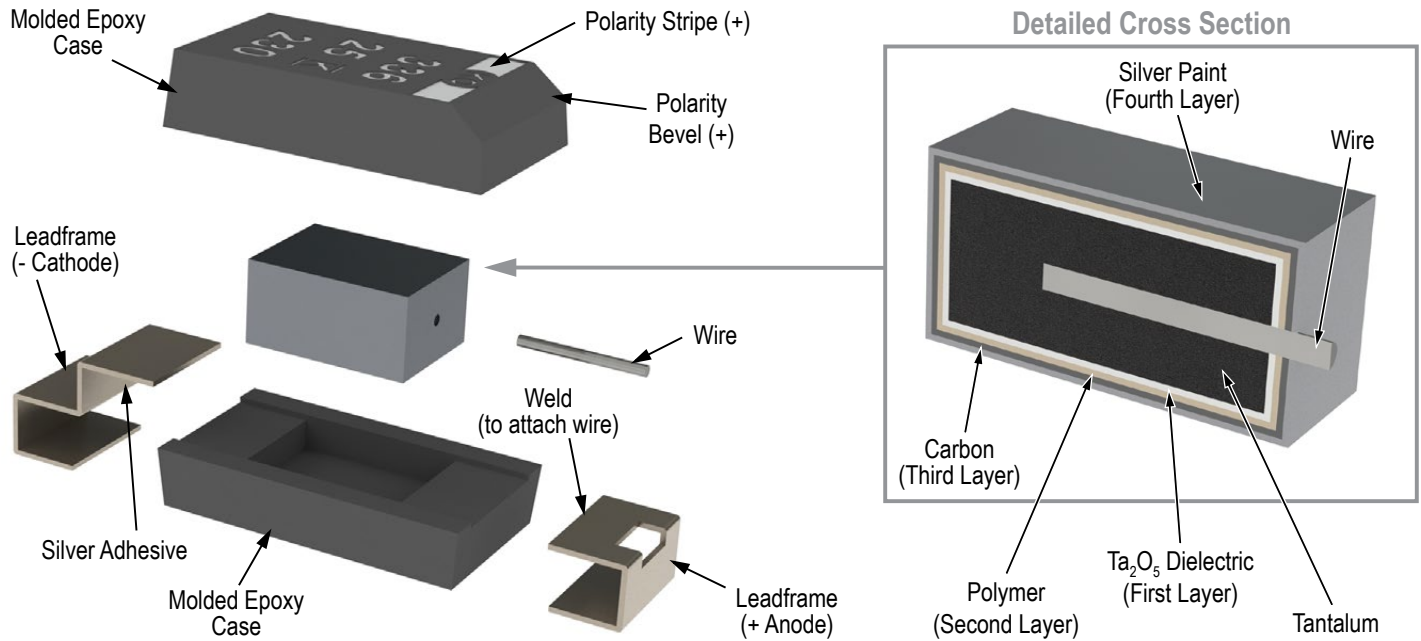

## Capacitor Marking

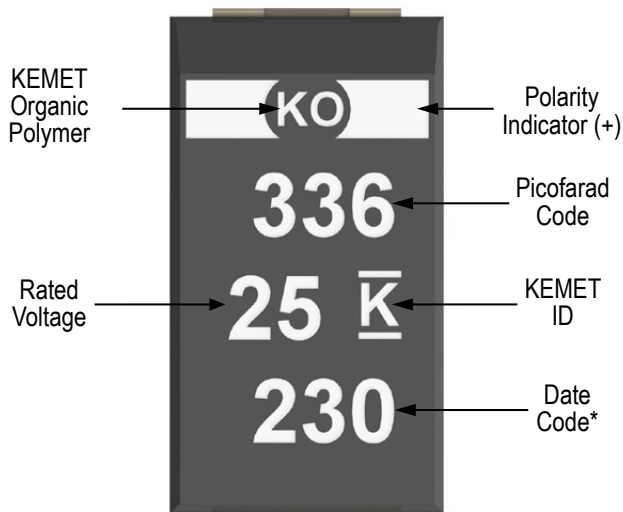

\* 230 = 30<sup>th</sup> week of 2012

| Date Code *  |  |
|--|--|
| 1 <sup>st</sup> digit = Last number of Year                  | 9 = 2009<br>0 = 2010<br>1 = 2011<br>2 = 2012<br>3 = 2013<br>4 = 2014               |
| 2 <sup>nd</sup> and 3 <sup>rd</sup> digit = Week of the Year | 01 = 1 <sup>st</sup> week of the Year to<br>52 = 52 <sup>nd</sup> week of the Year |

## Tape & Reel Packaging Information

KEMET’s molded chip capacitor families are packaged in 8 and 12 mm plastic tape on 7" and 13" reels in accordance with *EIA Standard 481: Embossed Carrier Taping of Surface Mount Components for Automatic Handling*. This packaging system is compatible with all tape-fed automatic pick-and-place systems.

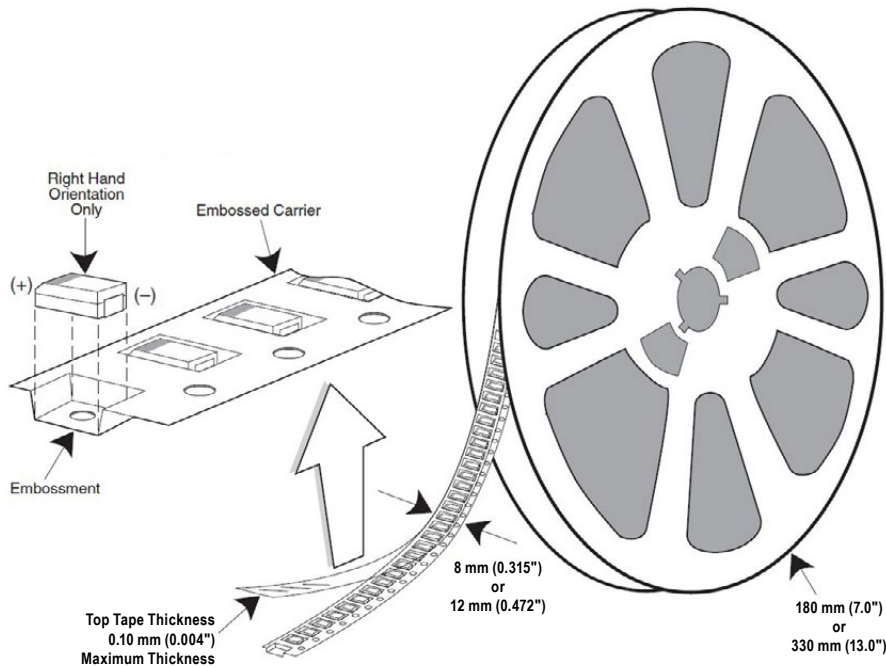

**Table 3 – Packaging Quantity**

| Case Code |         | Tape Width (mm) | 7" Reel* | 13" Reel* |
|-----------|---------|-----------------|----------|-----------|
| KEMET     | EIA     |                 |          |           |
| R         | 2012-12 | 8               | 2,500    | 10,000    |
| I         | 3216-10 | 8               | 3,000    | 12,000    |
| S         | 3216-12 | 8               | 2,500    | 10,000    |
| T         | 3528-12 | 8               | 2,500    | 10,000    |
| M         | 3528-15 | 8               | 2,000    | 8,000     |
| U         | 6032-15 | 12              | 1,000    | 5,000     |
| L         | 6032-19 | 12              | 1,000    | 3,000     |
| W         | 7343-15 | 12              | 1,000    | 3,000     |
| Z         | 7343-17 | 12              | 1,000    | 3,000     |
| Q         | 7343-12 | 12              | 1,000    | 3,000     |
| V         | 7343-19 | 12              | 1,000    | 3,000     |
| A         | 3216-18 | 8               | 2,000    | 9,000     |
| B         | 3528-21 | 8               | 2,000    | 8,000     |
| C         | 6032-28 | 12              | 500      | 3,000     |
| D         | 7343-31 | 12              | 500      | 2,500     |
| Y         | 7343-40 | 12              | 500      | 2,000     |
| X         | 7343-43 | 12              | 500      | 2,000     |
| E/T428P   | 7360-38 | 12              | 500      | 2,000     |
| H         | 7360-20 | 12              | 1,000    | 3,000     |

\* No C-Spec required for 7" reel packaging. C-7280 required for 13" reel packaging.

\* A case with black epoxy only available in 7" reel

**Figure 1 – Embossed (Plastic) Carrier Tape Dimensions**



**Table 4 – Embossed (Plastic) Carrier Tape Dimensions**

Metric will govern

| Constant Dimensions — Millimeters (Inches) |                                       |                                  |                              |                             |  |                        |                                  |  |                        |                            |               |
|--|---------------------------------------|----------------------------------|------------------------------|-----------------------------|--|------------------------|----------------------------------|--|------------------------|----------------------------|---------------|
| Tape Size                                  | D <sub>0</sub>                        | D <sub>1</sub> Minimum<br>Note 1 | E <sub>1</sub>               | P <sub>0</sub>              | P <sub>2</sub>   | R Reference<br>Note 2  | S <sub>1</sub> Minimum<br>Note 3 | T Maximum  | T <sub>1</sub> Maximum |                            |               |
| 8 mm                                       | 1.5 +0.10/-0.0<br>(0.059 +0.004/-0.0) | 1.0<br>(0.039)                   | 1.75 ±0.10<br>(0.069 ±0.004) | 4.0 ±0.10<br>(0.157 ±0.004) | 2.0 ±0.05<br>(0.079 ±0.002)  | 25.0<br>(0.984)        | 0.600<br>(0.024)                 | 0.600<br>(0.024)                                 | 0.100<br>(0.004)       |                            |               |
| 12 mm                                      |                                       | 1.5<br>(0.059)                   |                              |                             |  |                        |                                  |  |                        | 2.0 ±0.1<br>(0.079 ±0.059) | 30<br>(1.181) |
| 16 mm                                      |                                       |                                  |                              |                             |  |                        |                                  |  |                        |                            |               |
| Variable Dimensions — Millimeters (Inches) |                                       |                                  |                              |                             |  |                        |                                  |  |                        |                            |               |
| Tape Size                                  | Pitch                                 | B <sub>1</sub> Maximum<br>Note 4 | E <sub>2</sub> Minimum       | F                           | P <sub>1</sub>   | T <sub>2</sub> Maximum | W Maximum                        | A <sub>0</sub> , B <sub>0</sub> & K <sub>0</sub> |                        |                            |               |
| 8 mm                                       | Single (4 mm)                         | 4.35<br>(0.171)                  | 6.25<br>(0.246)              | 3.5 ±0.05<br>(0.138 ±0.002) | 2.0 ±0.05 or 4.0 ±0.10<br>(0.079 ±0.002 or 0.157 ±0.004)                               | 2.5<br>(0.098)         | 8.3<br>(0.327)                   | Note 5   |                        |                            |               |
| 12 mm                                      | Single (4 mm) &<br>Double (8 mm)      | 8.2<br>(0.323)                   | 10.25<br>(0.404)             | 5.5 ±0.05<br>(0.217 ±0.002) | 2.0 ±0.05 (0.079 ±0.002) or 4.0<br>±0.10 (0.157 ±0.004) or 8.0 ±0.10<br>(0.315 ±0.004) | 4.6<br>(0.181)         | 12.3<br>(0.484)                  |  |                        |                            |               |
| 16 mm                                      | Triple (12 mm)                        | 12.1<br>(0.476)                  | 14.25<br>(0.561)             | 7.5 ±0.10<br>(0.295 ±0.004) | 4.0 ±0.10 (0.157 ±0.004) to 12.0<br>±0.10 (0.472 ±0.004)                               | 8.0 (0.315)            | 16.3<br>(0.642)                  |  |                        |                            |               |

1. The embossment hole location shall be measured from the sprocket hole controlling the location of the embossment. Dimensions of embossment location and hole location shall be applied independent of each other.
2. The tape, with or without components, shall pass around R without damage (see Figure 4).
3. If S<sub>1</sub> < 1.0 mm, there may not be enough area for cover tape to be properly applied (see EIA Standard 481–D, paragraph 4.3, section b).
4. B<sub>1</sub> dimension is a reference dimension for tape feeder clearance only.
5. The cavity defined by A<sub>0</sub>, B<sub>0</sub> and K<sub>0</sub> shall surround the component with sufficient clearance that:
  - (a) the component does not protrude above the top surface of the carrier tape.
  - (b) the component can be removed from the cavity in a vertical direction without mechanical restriction, after the top cover tape has been removed.
  - (c) rotation of the component is limited to 20° maximum for 8 and 12 mm tapes and 10° maximum for 16 mm tapes (see Figure 2).
  - (d) lateral movement of the component is restricted to 0.5 mm maximum for 8 mm and 12 mm wide tape and to 1.0 mm maximum for 16 mm tape (see Figure 3).
  - (e) see Addendum in EIA Standard 481–D for standards relating to more precise taping requirements.

## Packaging Information Performance Notes

- 1. Cover Tape Break Force:** 1.0 Kg minimum.
- 2. Cover Tape Peel Strength:** The total peel strength of the cover tape from the carrier tape shall be:

| Tape Width   | Peel Strength                    |
|--------------|----------------------------------|
| 8 mm         | 0.1 to 1.0 Newton (10 to 100 gf) |
| 12 and 16 mm | 0.1 to 1.3 Newton (10 to 130 gf) |

The direction of the pull shall be opposite the direction of the carrier tape travel. The pull angle of the carrier tape shall be 165° to 180° from the plane of the carrier tape. During peeling, the carrier and/or cover tape shall be pulled at a velocity of 300 ±10 mm/minute.

- 3. Labeling:** Bar code labeling (standard or custom) shall be on the side of the reel opposite the sprocket holes. Refer to EIA Standards 556 and 624.

### Figure 2 – Maximum Component Rotation

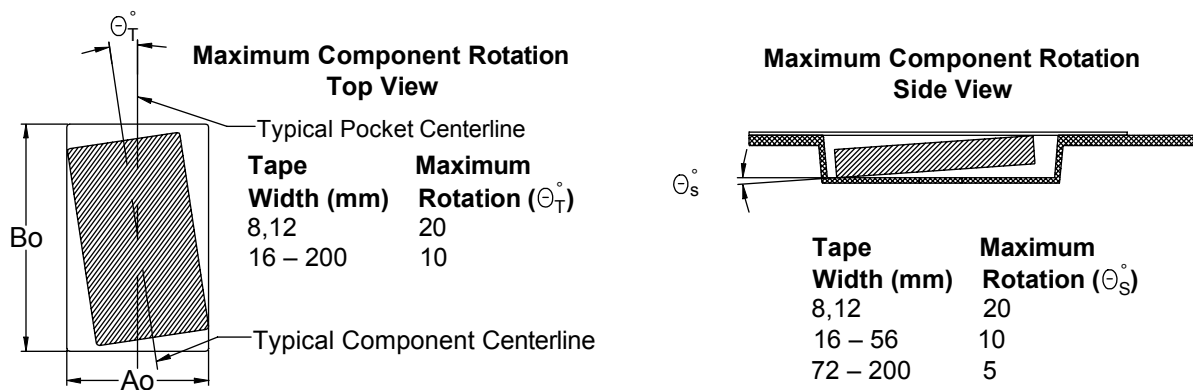

### Figure 3 – Maximum Lateral Movement

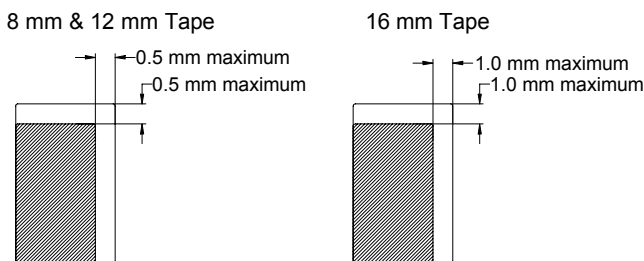

### Figure 4 – Bending Radius

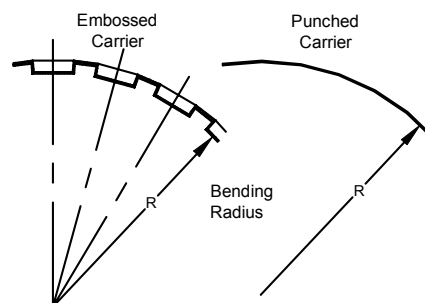

**Figure 5 – Reel Dimensions**

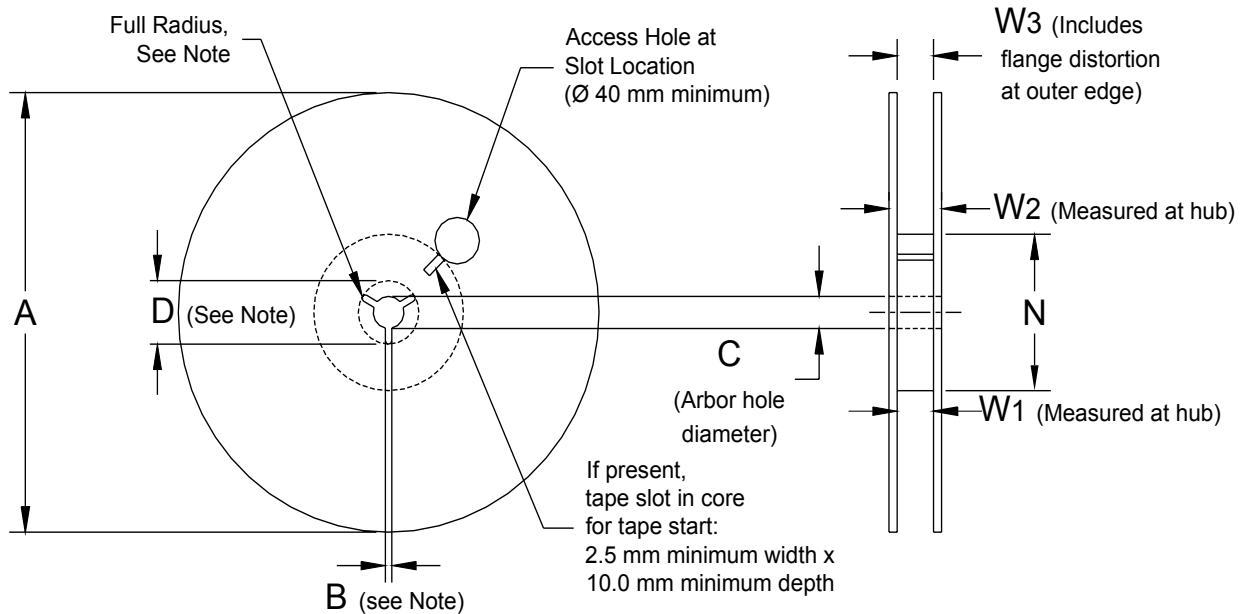
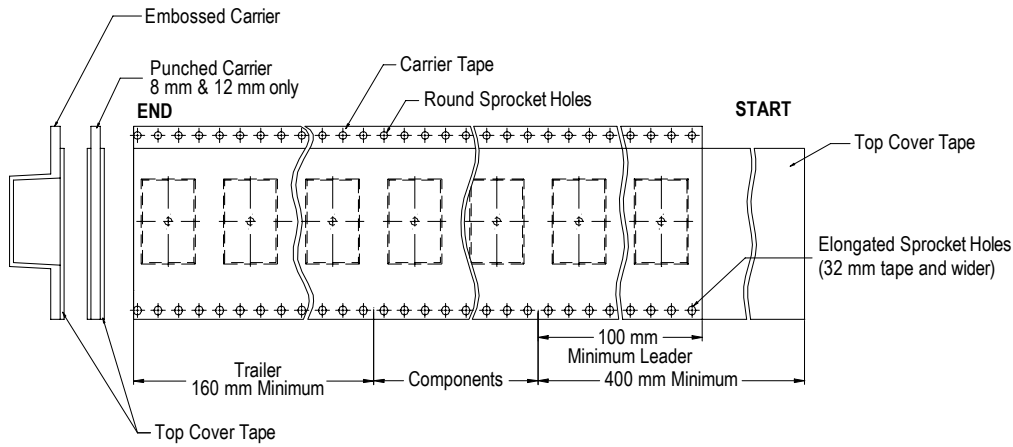

**Table 5 – Reel Dimensions**

Metric will govern

| Constant Dimensions — Millimeters (Inches) |   |                                       |  |   |
|--|---|---------------------------------------|--|---|
| Tape Size                                  | A   | B Minimum                             | C                                      | D Minimum   |
| 8 mm                                       | 178 ±0.20<br>(7.008 ±0.008)<br>or<br>330 ±0.20<br>(13.000 ±0.008) | 1.5<br>(0.059)                        | 13.0 +0.5/-0.2<br>(0.521 +0.02/-0.008) | 20.2<br>(0.795)                                   |
| 12 mm                                      |   |                                       |  |   |
| 16 mm                                      |   |                                       |  |   |
| Variable Dimensions — Millimeters (Inches) |   |                                       |  |   |
| Tape Size                                  | N Minimum   | W <sub>1</sub>                        | W <sub>2</sub> Maximum                 | W <sub>3</sub>                                    |
| 8 mm                                       | 50<br>(1.969)   | 8.4 +1.5/-0.0<br>(0.331 +0.059/-0.0)  | 14.4<br>(0.567)                        | Shall accommodate tape width without interference |
| 12 mm                                      |   | 12.4 +2.0/-0.0<br>(0.488 +0.078/-0.0) | 18.4<br>(0.724)                        |   |
| 16 mm                                      |   | 16.4 +2.0/-0.0<br>(0.646 +0.078/-0.0) | 22.4<br>(0.882)                        |   |

**Figure 6 – Tape Leader & Trailer Dimensions**



**Figure 7 – Maximum Camber**

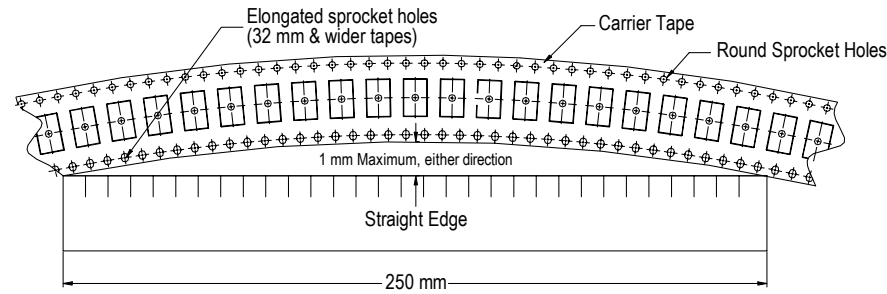

## KEMET Corporation World Headquarters

2835 KEMET Way  
Simpsonville, SC 29681

Mailing Address:  
P.O. Box 5928  
Greenville, SC 29606

www.kemet.com  
Tel: 864-963-6300  
Fax: 864-963-6521

**Corporate Offices**  
Fort Lauderdale, FL  
Tel: 954-766-2800

## North America

### Southeast

Lake Mary, FL  
Tel: 407-855-8886

### Northeast

Wilmington, MA  
Tel: 978-658-1663

### Central

Novi, MI  
Tel: 248-994-1030

### West

Milpitas, CA  
Tel: 408-433-9950

### Mexico

Guadalajara, Jalisco  
Tel: 52-33-3123-2141

## Europe

### Southern Europe

Sasso Marconi, Italy  
Tel: 39-051-939111

Skopje, Macedonia  
Tel: 389-2-55-14-623

### Central Europe

Landsberg, Germany  
Tel: 49-8191-3350800

Kamen, Germany  
Tel: 49-2307-438110

### Northern Europe

Wyboston, United Kingdom  
Tel: 44-1480-273082

Espoo, Finland  
Tel: 358-9-5406-5000

## Asia

### Northeast Asia

Hong Kong  
Tel: 852-2305-1168

Shenzhen, China  
Tel: 86-755-2518-1306

Beijing, China  
Tel: 86-10-5877-1075

Shanghai, China  
Tel: 86-21-6447-0707

Seoul, South Korea  
Tel: 82-2-6294-0550

Taipei, Taiwan  
Tel: 886-2-27528585

### Southeast Asia

Singapore  
Tel: 65-6701-8033

Penang, Malaysia  
Tel: 60-4-6430200

Bangalore, India  
Tel: 91-806-53-76817

*Note: KEMET reserves the right to modify minor details of internal and external construction at any time in the interest of product improvement. KEMET does not assume any responsibility for infringement that might result from the use of KEMET Capacitors in potential circuit designs. KEMET is a registered trademark of KEMET Electronics Corporation.*



## Disclaimer

All product specifications, statements, information and data (collectively, the "Information") in this datasheet are subject to change. The customer is responsible for checking and verifying the extent to which the Information contained in this publication is applicable to an order at the time the order is placed.

All Information given herein is believed to be accurate and reliable, but it is presented without guarantee, warranty, or responsibility of any kind, expressed or implied.

Statements of suitability for certain applications are based on KEMET Electronics Corporation's ("KEMET") knowledge of typical operating conditions for such applications, but are not intended to constitute – and KEMET specifically disclaims – any warranty concerning suitability for a specific customer application or use. The Information is intended for use only by customers who have the requisite experience and capability to determine the correct products for their application. Any technical advice inferred from this Information or otherwise provided by KEMET with reference to the use of KEMET's products is given gratis, and KEMET assumes no obligation or liability for the advice given or results obtained.

Although KEMET designs and manufactures its products to the most stringent quality and safety standards, given the current state of the art, isolated component failures may still occur. Accordingly, customer applications which require a high degree of reliability or safety should employ suitable designs or other safeguards (such as installation of protective circuitry or redundancies) in order to ensure that the failure of an electrical component does not result in a risk of personal injury or property damage.

Although all product-related warnings, cautions and notes must be observed, the customer should not assume that all safety measures are indicated or that other measures may not be required.



## Стандарт Электрон Связь

Мы молодая и активно развивающаяся компания в области поставок электронных компонентов. Мы поставляем электронные компоненты отечественного и импортного производства напрямую от производителей и с крупнейших складов мира.

Благодаря сотрудничеству с мировыми поставщиками мы осуществляем комплексные и плановые поставки широчайшего спектра электронных компонентов.

Собственная эффективная логистика и склад в обеспечивает надежную поставку продукции в точно указанные сроки по всей России.

Мы осуществляем техническую поддержку нашим клиентам и предпродажную проверку качества продукции. На все поставляемые продукты мы предоставляем гарантию .

Осуществляем поставки продукции под контролем ВП МО РФ на предприятия военно-промышленного комплекса России , а также работаем в рамках 275 ФЗ с открытием отдельных счетов в уполномоченном банке. Система менеджмента качества компании соответствует требованиям ГОСТ ISO 9001.

Минимальные сроки поставки, гибкие цены, неограниченный ассортимент и индивидуальный подход к клиентам являются основой для выстраивания долгосрочного и эффективного сотрудничества с предприятиями радиоэлектронной промышленности, предприятиями ВПК и научно-исследовательскими институтами России.

С нами вы становитесь еще успешнее!

### Наши контакты:

**Телефон:** +7 812 627 14 35

**Электронная почта:** [sales@st-electron.ru](mailto:sales@st-electron.ru)

**Адрес:** 198099, Санкт-Петербург,  
Промышленная ул, дом № 19, литера Н,  
помещение 100-Н Офис 331