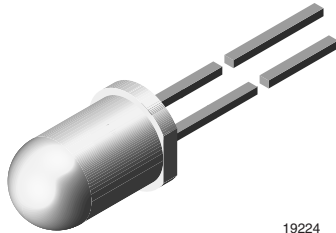


## High Efficiency LED in Ø 5 mm Tinted Diffused Package



19224

### DESCRIPTION

The TLH.640. series was developed for standard applications like general indicating and lighting purposes.

It is housed in a 5 mm tinted diffused plastic package. The wide viewing angle of these devices provides a high on-off contrast.

Several selection types with different luminous intensities are offered. All LEDs are categorized in luminous intensity groups. The green and yellow LEDs are categorized additionally in wavelength groups.

That allows users to assemble LEDs with uniform appearance.

### FEATURES

- Choice of three bright colors
- Standard T-1 $\frac{3}{4}$  package
- Small mechanical tolerances
- Suitable for DC and high peak current
- Wide viewing angle
- Luminous intensity categorized
- Yellow and green color categorized
- TLH.640. without stand-offs
- Compliant to RoHS directive 2002/95/EC and in accordance to WEEE 2002/96/EC


**RoHS**  
COMPLIANT

### APPLICATIONS

- Status lights
- Off/on indicator
- Background illumination
- Readout lights
- Maintenance lights
- Legend light

### PRODUCT GROUP AND PACKAGE DATA

- Product group: LED
- Package: 5 mm
- Product series: standard
- Angle of half intensity:  $\pm 30^\circ$

PARTS TABLE		
PART	COLOR, LUMINOUS INTENSITY	TECHNOLOGY
TLHR6400	Red, $I_V = 10$ mcd (typ.)	GaAsP on GaP
TLHR6400-CS12Z	Red, $I_V = 10$ mcd (typ.)	GaAsP on GaP
TLHR6401	Red, $I_V = 12$ mcd (typ.)	GaAsP on GaP
TLHR6405	Red, $I_V = 14$ mcd (typ.)	GaAsP on GaP
TLHR6405-ASZ	Red, $I_V = 14$ mcd (typ.)	GaAsP on GaP
TLHR6405-BT12Z	Red, $I_V = 14$ mcd (typ.)	GaAsP on GaP
TLHY6400	Yellow, $I_V = 10$ mcd (typ.)	GaAsP on GaP
TLHY6400-CS12Z	Yellow, $I_V = 10$ mcd (typ.)	GaAsP on GaP
TLHY6400-MS12Z	Yellow, $I_V = 10$ mcd (typ.)	GaAsP on GaP
TLHY6401	Yellow, $I_V = 12$ mcd (typ.)	GaAsP on GaP
TLHY6405	Yellow, $I_V = 14$ mcd (typ.)	GaAsP on GaP
TLHY6405-ASZ	Yellow, $I_V = 14$ mcd (typ.)	GaAsP on GaP
TLHY6405-BTZ	Yellow, $I_V = 14$ mcd (typ.)	GaAsP on GaP
TLHG6400	Green, $I_V = 10$ mcd (typ.)	GaP on GaP
TLHG6400-AS12Z	Green, $I_V = 10$ mcd (typ.)	GaP on GaP
TLHG6400-CS12Z	Green, $I_V = 10$ mcd (typ.)	GaP on GaP
TLHG6401	Green, $I_V = 12$ mcd (typ.)	GaP on GaP

PARTS TABLE		
PART	COLOR, LUMINOUS INTENSITY	TECHNOLOGY
TLHG6401-AS12Z	Green, $I_V = 12$ mcd (typ.)	GaP on GaP
TLHG6405	Green, $I_V > 15$ mcd (typ.)	GaP on GaP
TLHG6405-ASZ	Green, $I_V > 15$ mcd (typ.)	GaP on GaP
TLHG6405-BTZ	Green, $I_V > 15$ mcd (typ.)	GaP on GaP

ABSOLUTE MAXIMUM RATINGS <sup>1)</sup> TLHR640. , TLHY640. , TLHG640.				
PARAMETER	TEST CONDITION	SYMBOL	VALUE	UNIT
Reverse voltage		$V_R$	6	V
DC Forward current	$T_{amb} \leq 65$ °C	$I_F$	30	mA
Surge forward current	$t_p \leq 10$ $\mu$ s	$I_{FSM}$	1	A
Power dissipation	$T_{amb} \leq 65$ °C	$P_V$	100	mW
Junction temperature		$T_j$	100	°C
Operating temperature range		$T_{amb}$	- 20 to + 100	°C
Storage temperature range		$T_{stg}$	- 55 to + 100	°C
Soldering temperature	$t \leq 5$ s, 2 mm from body	$T_{sd}$	260	°C
Thermal resistance junction/ambient		$R_{thJA}$	350	K/W

Note:

<sup>1)</sup>  $T_{amb} = 25$  °C, unless otherwise specified

OPTICAL AND ELECTRICAL CHARACTERISTICS <sup>1)</sup> TLHR640., RED							
PARAMETER	TEST CONDITION	PART	SYMBOL	MIN.	TYP.	MAX.	UNIT
Luminous intensity <sup>2)</sup>	$I_F = 10$ mA	TLHR6400	$I_V$	1.6	10		mcd
		TLHR6401	$I_V$	4	12		mcd
		TLHR6405	$I_V$	6.3	14		mcd
Dominant wavelength	$I_F = 10$ mA		$\lambda_d$	612		625	nm
Peak wavelength	$I_F = 10$ mA		$\lambda_p$		635		nm
Angle of half intensity	$I_F = 10$ mA		$\varphi$		$\pm 30$		deg
Forward voltage	$I_F = 20$ mA		$V_F$		2	3	V
Reverse voltage	$I_R = 10$ $\mu$ A		$V_R$	6	15		V
Junction capacitance	$V_R = 0$ , $f = 1$ MHz		$C_j$		50		pF

Note:

<sup>1)</sup>  $T_{amb} = 25$  °C, unless otherwise specified

<sup>2)</sup> In one packing unit  $I_{Vmin.}/I_{Vmax.} \leq 0.5$

OPTICAL AND ELECTRICAL CHARACTERISTICS <sup>1)</sup> TLHY640., YELLOW							
PARAMETER	TEST CONDITION	PART	SYMBOL	MIN.	TYP.	MAX.	UNIT
Luminous intensity <sup>2)</sup>	$I_F = 10$ mA	TLHY6400	$I_V$	1.6	10		mcd
		TLHY6401	$I_V$	4	12		mcd
		TLHY6405	$I_V$	6.3	14		mcd
Dominant wavelength	$I_F = 10$ mA		$\lambda_d$	581		594	nm
Peak wavelength	$I_F = 10$ mA		$\lambda_p$		585		nm
Angle of half intensity	$I_F = 10$ mA		$\varphi$		$\pm 30$		deg
Forward voltage	$I_F = 20$ mA		$V_F$		2.4	3	V
Reverse voltage	$I_R = 10$ $\mu$ A		$V_R$	6	15		V
Junction capacitance	$V_R = 0$ , $f = 1$ MHz		$C_j$		50		pF

Note:

<sup>1)</sup>  $T_{amb} = 25$  °C, unless otherwise specified

<sup>2)</sup> In one packing unit  $I_{Vmin.}/I_{Vmax.} \leq 0.5$

OPTICAL AND ELECTRICAL CHARACTERISTICS <sup>1)</sup> TLHG640., GREEN							
PARAMETER	TEST CONDITION	PART	SYMBOL	MIN.	TYP.	MAX.	UNIT
Luminous intensity <sup>2)</sup>	$I_F = 10 \text{ mA}$	TLHG6400	$I_V$	1.6	10		mcd
		TLHG6401	$I_V$	4	12		mcd
		TLHG6405	$I_V$	6.3	15		mcd
Dominant wavelength	$I_F = 10 \text{ mA}$		$\lambda_d$	562		575	nm
Peak wavelength	$I_F = 10 \text{ mA}$		$\lambda_p$		565		nm
Angle of half intensity	$I_F = 10 \text{ mA}$		$\phi$		$\pm 30$		deg
Forward voltage	$I_F = 20 \text{ mA}$		$V_F$		2.4	3	V
Reverse voltage	$I_R = 10 \mu\text{A}$		$V_R$	6	15		V
Junction capacitance	$V_R = 0, f = 1 \text{ MHz}$		$C_j$		50		pF

Note:

<sup>1)</sup>  $T_{amb} = 25 \text{ }^\circ\text{C}$ , unless otherwise specified

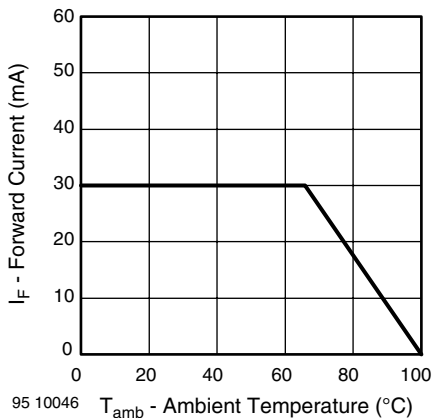
<sup>2)</sup> In one packing unit  $I_{Vmin.}/I_{Vmax.} \leq 0.5$ 
**TYPICAL CHARACTERISTICS**
 $T_{amb} = 25 \text{ }^\circ\text{C}$ , unless otherwise specified


Figure 1. Forward Current vs. Ambient Temperature

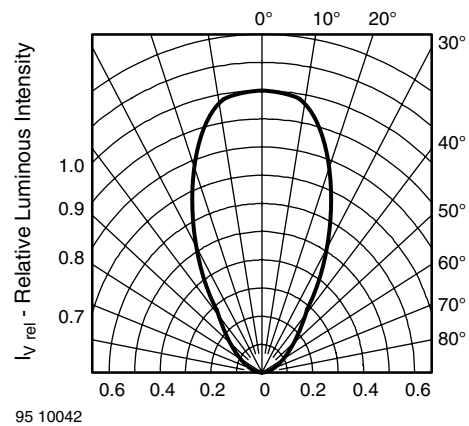


Figure 3. Rel. Luminous Intensity vs. Angular Displacement

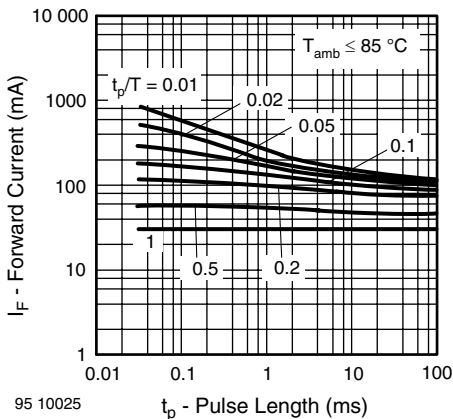


Figure 2. Forward Current vs. Pulse Length

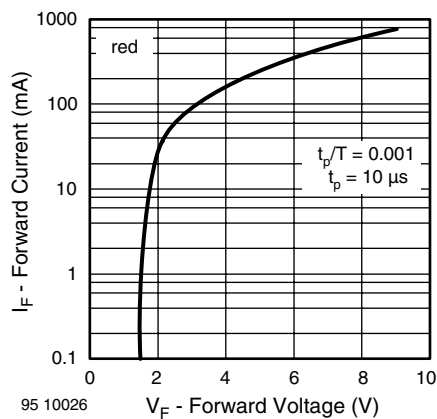


Figure 4. Forward Current vs. Forward Voltage

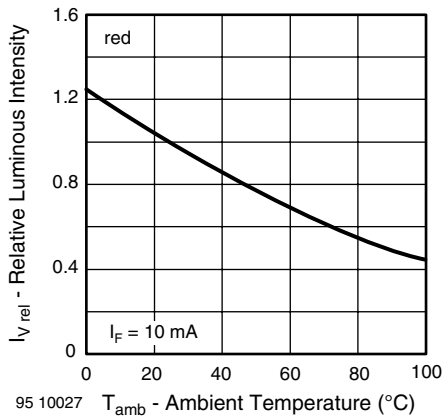


Figure 5. Rel. Luminous Intensity vs. Ambient Temperature

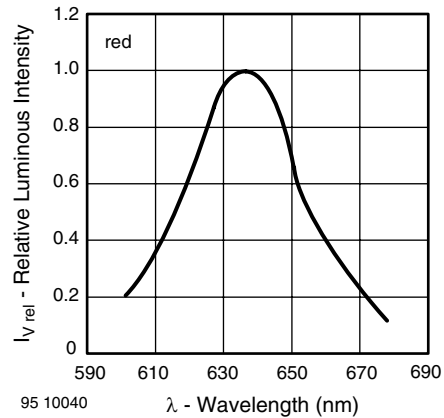


Figure 8. Relative Intensity vs. Wavelength

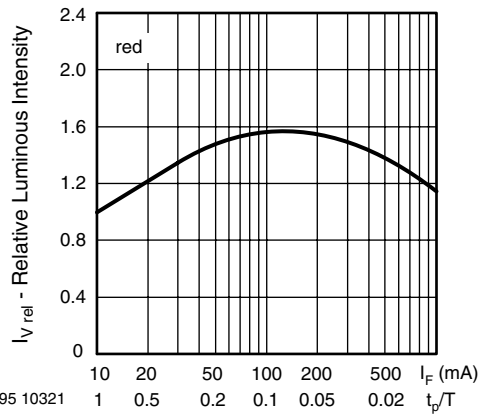


Figure 6. Rel. Lumin. Intensity vs. Forw. Current/Duty Cycle

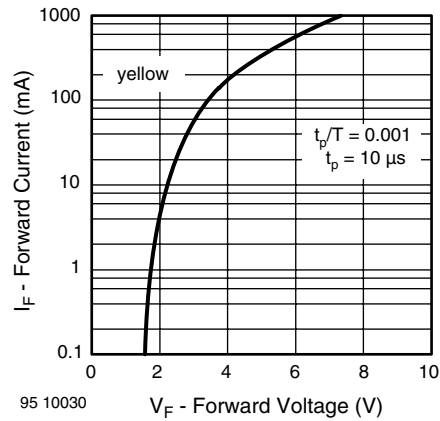


Figure 9. Forward Current vs. Forward Voltage

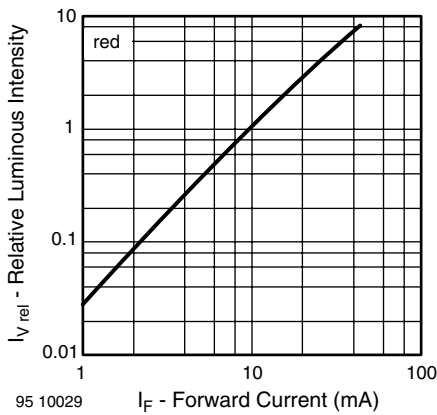


Figure 7. Relative Luminous Intensity vs. Forward Current

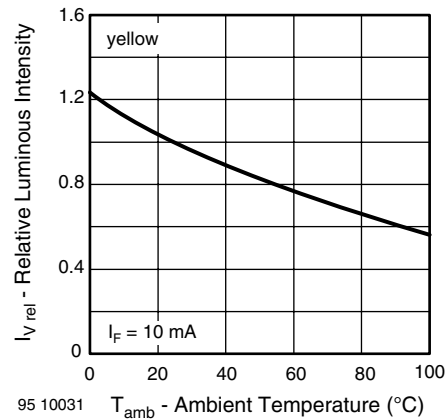


Figure 10. Rel. Luminous Intensity vs. Ambient Temperature

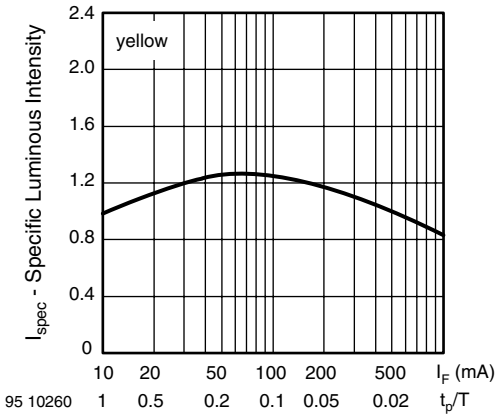


Figure 11. Rel. Lumin. Intensity vs. Forw. Current/Duty Cycle

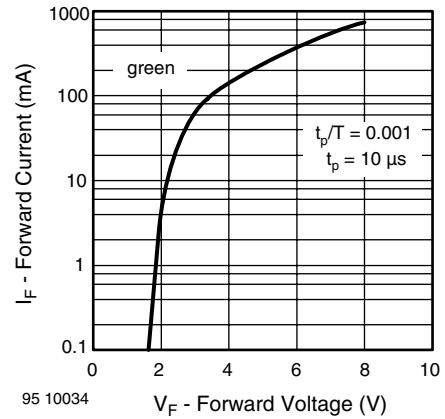


Figure 14. Forward Current vs. Forward Voltage

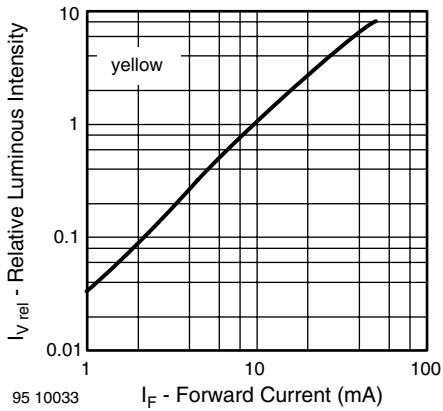


Figure 12. Relative Luminous Intensity vs. Forward Current

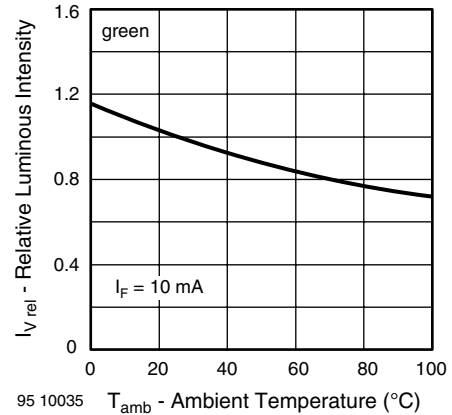


Figure 15. Rel. Luminous Intensity vs. Ambient Temperature

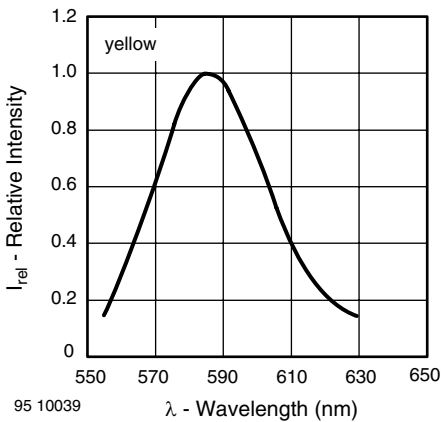


Figure 13. Relative Intensity vs. Wavelength

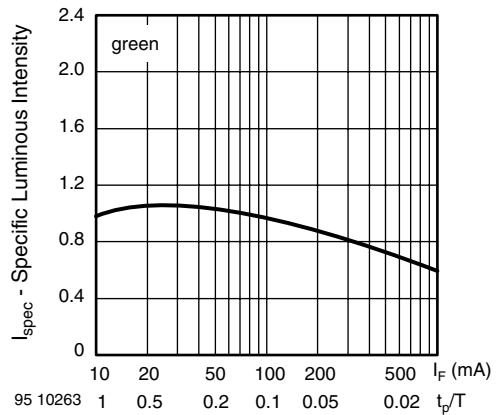


Figure 16. Specific Luminous Intensity vs. Forward Current

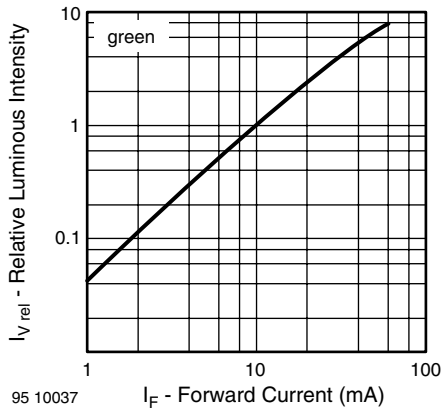


Figure 17. Relative Luminous Intensity vs. Forward Current

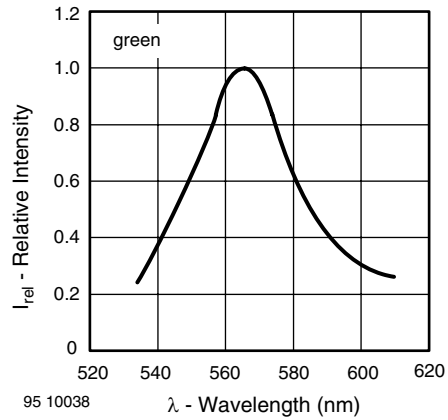
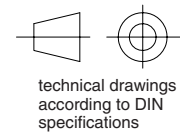
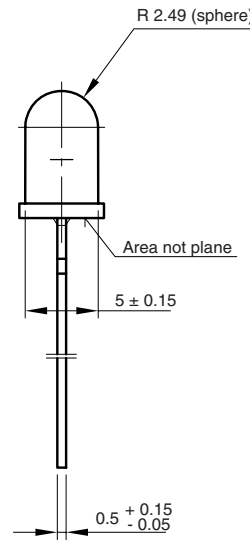
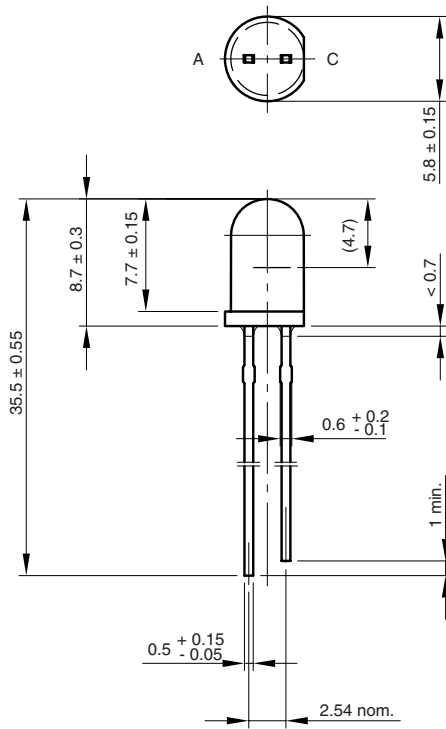


Figure 18. Relative Intensity vs. Wavelength

## PACKAGE DIMENSIONS in millimeters



6.544-5259.02-4  
Issue: 8; 19.05.09  
95 10917

## REEL

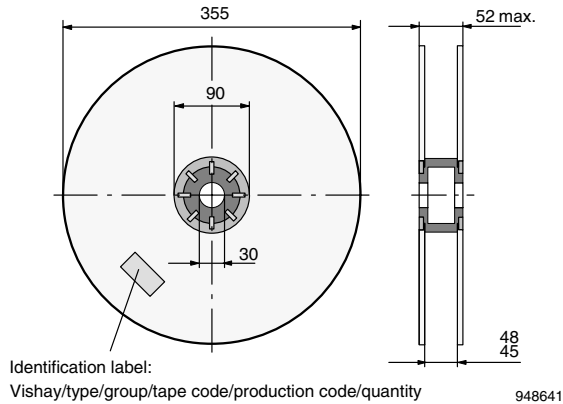


Figure 19. Reel Dimensions

AS12 = cathode leaves tape first  
AS21 = anode leaves tape first

## AMMOPACK

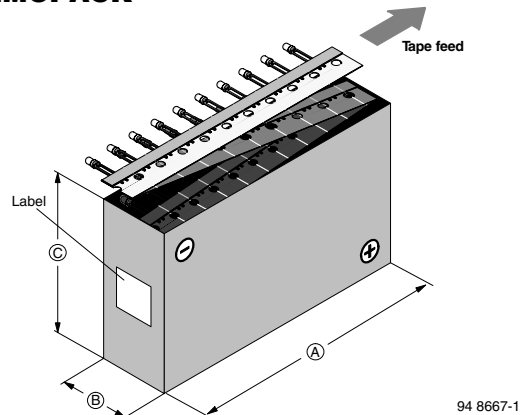


Figure 21. Tape Direction

Note:  
AS12Z and AS21Z still valid for already existing types BUT NOT FOR NEW DESIGN

## TAPE

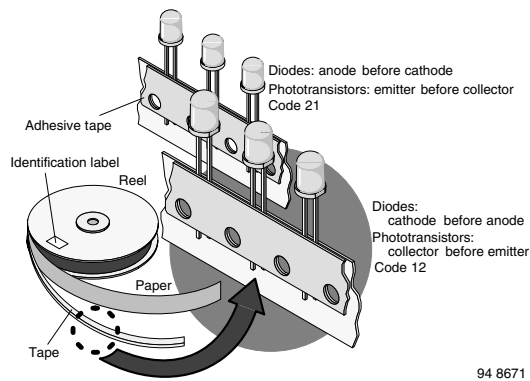
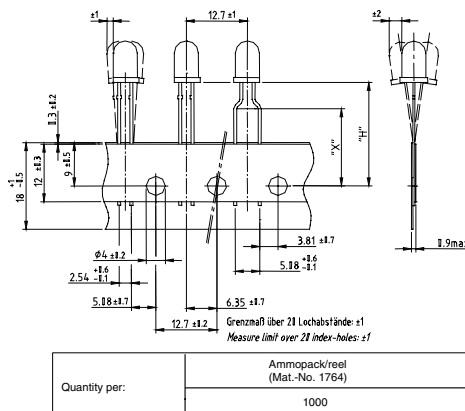


Figure 20. LED in Tape

## TAPE DIMENSIONS in millimeters



Option	Dim. "H" ± 0.5 mm	Dim. "X" ± 0.5 mm
AS	17.3	
BT	20.0	16.0
CS	22.0	
MS	25.5	



## Disclaimer

ALL PRODUCT, PRODUCT SPECIFICATIONS AND DATA ARE SUBJECT TO CHANGE WITHOUT NOTICE TO IMPROVE RELIABILITY, FUNCTION OR DESIGN OR OTHERWISE.

Vishay Intertechnology, Inc., its affiliates, agents, and employees, and all persons acting on its or their behalf (collectively, "Vishay"), disclaim any and all liability for any errors, inaccuracies or incompleteness contained in any datasheet or in any other disclosure relating to any product.

Vishay makes no warranty, representation or guarantee regarding the suitability of the products for any particular purpose or the continuing production of any product. To the maximum extent permitted by applicable law, Vishay disclaims (i) any and all liability arising out of the application or use of any product, (ii) any and all liability, including without limitation special, consequential or incidental damages, and (iii) any and all implied warranties, including warranties of fitness for particular purpose, non-infringement and merchantability.

Statements regarding the suitability of products for certain types of applications are based on Vishay's knowledge of typical requirements that are often placed on Vishay products in generic applications. Such statements are not binding statements about the suitability of products for a particular application. It is the customer's responsibility to validate that a particular product with the properties described in the product specification is suitable for use in a particular application. Parameters provided in datasheets and/or specifications may vary in different applications and performance may vary over time. All operating parameters, including typical parameters, must be validated for each customer application by the customer's technical experts. Product specifications do not expand or otherwise modify Vishay's terms and conditions of purchase, including but not limited to the warranty expressed therein.

Except as expressly indicated in writing, Vishay products are not designed for use in medical, life-saving, or life-sustaining applications or for any other application in which the failure of the Vishay product could result in personal injury or death. Customers using or selling Vishay products not expressly indicated for use in such applications do so at their own risk. Please contact authorized Vishay personnel to obtain written terms and conditions regarding products designed for such applications.

No license, express or implied, by estoppel or otherwise, to any intellectual property rights is granted by this document or by any conduct of Vishay. Product names and markings noted herein may be trademarks of their respective owners.

## Material Category Policy

**Vishay Intertechnology, Inc. hereby certifies that all its products that are identified as RoHS-Compliant fulfill the definitions and restrictions defined under Directive 2011/65/EU of The European Parliament and of the Council of June 8, 2011 on the restriction of the use of certain hazardous substances in electrical and electronic equipment (EEE) - recast, unless otherwise specified as non-compliant.**

**Please note that some Vishay documentation may still make reference to RoHS Directive 2002/95/EC. We confirm that all the products identified as being compliant to Directive 2002/95/EC conform to Directive 2011/65/EU.**

**Vishay Intertechnology, Inc. hereby certifies that all its products that are identified as Halogen-Free follow Halogen-Free requirements as per JEDEC JS709A standards. Please note that some Vishay documentation may still make reference to the IEC 61249-2-21 definition. We confirm that all the products identified as being compliant to IEC 61249-2-21 conform to JEDEC JS709A standards.**





**Стандарт  
Электрон  
Связь**

Мы молодая и активно развивающаяся компания в области поставок электронных компонентов. Мы поставляем электронные компоненты отечественного и импортного производства напрямую от производителей и с крупнейших складов мира.

Благодаря сотрудничеству с мировыми поставщиками мы осуществляем комплексные и плановые поставки широчайшего спектра электронных компонентов.

Собственная эффективная логистика и склад в обеспечивает надежную поставку продукции в точно указанные сроки по всей России.

Мы осуществляем техническую поддержку нашим клиентам и предпродажную проверку качества продукции. На все поставляемые продукты мы предоставляем гарантию .

Осуществляем поставки продукции под контролем ВП МО РФ на предприятия военно-промышленного комплекса России , а также работаем в рамках 275 ФЗ с открытием отдельных счетов в уполномоченном банке. Система менеджмента качества компании соответствует требованиям ГОСТ ISO 9001.

Минимальные сроки поставки, гибкие цены, неограниченный ассортимент и индивидуальный подход к клиентам являются основой для выстраивания долгосрочного и эффективного сотрудничества с предприятиями радиоэлектронной промышленности, предприятиями ВПК и научно-исследовательскими институтами России.

С нами вы становитесь еще успешнее!

**Наши контакты:**

**Телефон:** +7 812 627 14 35

**Электронная почта:** [sales@st-electron.ru](mailto:sales@st-electron.ru)

**Адрес:** 198099, Санкт-Петербург,  
Промышленная ул, дом № 19, литера Н,  
помещение 100-Н Офис 331