

N-channel 600 V, 0.26 Ω typ., 12 A MDmesh™ M6 Power MOSFET in a TO-220FP package

Datasheet - production data

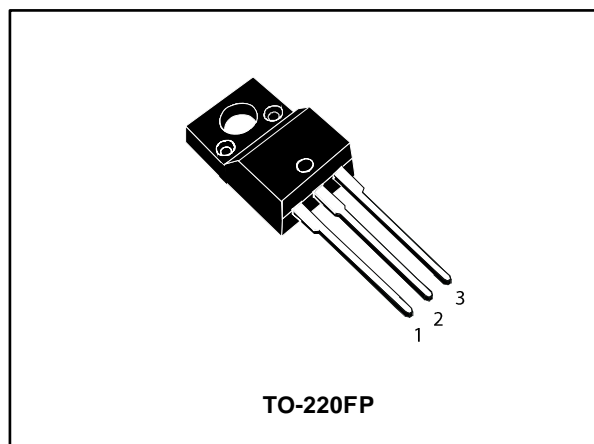
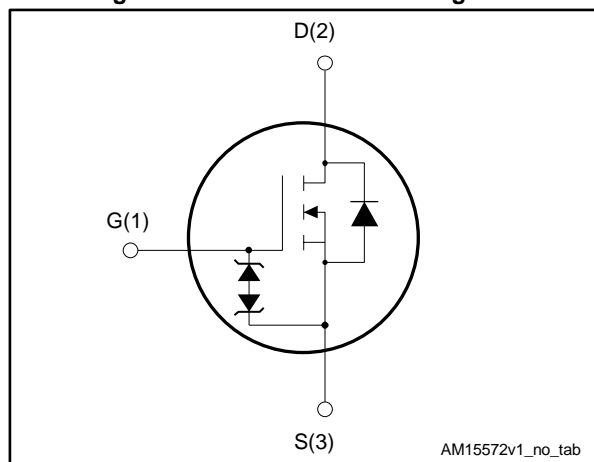

Figure 1: Internal schematic diagram



Features

Order code	V _{DS}	R _{DS(on)} max.	I _D
STF16N60M6	600 V	0.32 Ω	12 A

- Reduced switching losses
- Lower R_{DS(on)} x area vs previous generation
- Low gate input resistance
- 100% avalanche tested
- Zener-protected

Applications

- Switching applications
- LLC converters
- Boost PFC converters

Description

The new MDmesh™ M6 technology incorporates the most recent advancements to the well-known and consolidated MDmesh family of SJ MOSFETs. STMicroelectronics builds on the previous generation of MDmesh devices through its new M6 technology, which combines excellent R_{DS(on)} * area improvement with one of the most effective switching behaviors available, as well as a user-friendly experience for maximum end-application efficiency.

Table 1: Device summary

Order code	Marking	Package	Packing
STF16N60M6	16N60M6	TO-220FP	Tube

Contents

1	Electrical ratings	3
2	Electrical characteristics	4
	2.1 Electrical characteristics (curves).....	6
3	Test circuits	8
4	Package information	9
	4.1 TO-220FP package information	10
5	Revision history	12

1 Electrical ratings

Table 2: Absolute maximum ratings

Symbol	Parameter	Value	Unit
V_{GS}	Gate-source voltage	± 25	V
I_D	Drain current (continuous) at $T_c = 25\text{ }^\circ\text{C}$	12 ⁽¹⁾	A
I_D	Drain current (continuous) at $T_c = 100\text{ }^\circ\text{C}$	7.6 ⁽¹⁾	A
I_{DM}	Drain current (pulsed)	32 ⁽¹⁾⁽²⁾	A
P_{TOT}	Total dissipation at $T_c = 25\text{ }^\circ\text{C}$	25	W
$dv/dt^{(3)}$	Peak diode recovery voltage slope	15	V/ns
$dv/dt^{(4)}$	MOSFET dv/dt ruggedness	50	
V_{ISO}	Insulation withstand voltage (RMS) from all three leads to external heat sink ($t = 1\text{ s}$; $T_c = 25\text{ }^\circ\text{C}$)	2.5	kV
T_{stg}	Storage temperature range	-55 to 150	$^\circ\text{C}$
T_j	Operating junction temperature range		

Notes:

(1) Limited by maximum junction temperature.

(2) Pulse width limited by safe operating area.

(3) $I_{SD} \leq 12\text{ A}$, $di/dt \leq 400\text{ A}/\mu\text{s}$; $V_{DS(peak)} < V_{(BR)DSS}$, $V_{DD} = 400\text{ V}$

(4) $V_{DS} \leq 480\text{ V}$

Table 3: Thermal data

Symbol	Parameter	Value	Unit
$R_{thj-case}$	Thermal resistance junction-case	5	$^\circ\text{C}/\text{W}$
$R_{thj-amb}$	Thermal resistance junction-ambient	62.5	

Table 4: Avalanche characteristics

Symbol	Parameter	Value	Unit
I_{AR}	Avalanche current, repetitive or not repetitive (pulse width limited by T_{jmax})	2.5	A
E_{AS}	Single pulse avalanche energy (starting $T_j = 25\text{ }^\circ\text{C}$, $I_D = I_{AR}$; $V_{DD} = 50\text{ V}$)	110	mJ

2 Electrical characteristics

($T_C = 25\text{ °C}$ unless otherwise specified)

Table 5: On /off states

Symbol	Parameter	Test conditions	Min.	Typ.	Max.	Unit
$V_{(BR)DSS}$	Drain-source breakdown voltage	$V_{GS} = 0\text{ V}$, $I_D = 1\text{ mA}$	600			V
I_{DSS}	Zero gate voltage drain current	$V_{GS} = 0\text{ V}$, $V_{DS} = 600\text{ V}$			1	μA
		$V_{GS} = 0\text{ V}$, $V_{DS} = 600\text{ V}$, $T_C = 125\text{ °C}$ ⁽¹⁾			100	
I_{GSS}	Gate-body leakage current	$V_{DS} = 0\text{ V}$, $V_{GS} = \pm 25\text{ V}$			± 5	μA
$V_{GS(th)}$	Gate threshold voltage	$V_{DS} = V_{GS}$, $I_D = 250\text{ }\mu\text{A}$	3.25	4	4.75	V
$R_{DS(on)}$	Static drain-source on-resistance	$V_{GS} = 10\text{ V}$, $I_D = 6\text{ A}$		0.26	0.32	Ω

Notes:

⁽¹⁾ Defined by design, not subject to production test.

Table 6: Dynamic

Symbol	Parameter	Test conditions	Min.	Typ.	Max.	Unit
C_{iss}	Input capacitance	$V_{GS} = 100\text{ V}$, $f = 1\text{ MHz}$, $V_{GS} = 0\text{ V}$	-	575	-	pF
C_{oss}	Output capacitance		-	33	-	
C_{rss}	Reverse transfer capacitance		-	3	-	
$C_{oss\text{ eq.}}^{(1)}$	Equivalent output capacitance	$V_{DS} = 0\text{ to }480\text{ V}$, $V_{GS} = 0\text{ V}$	-	104	-	pF
R_G	Intrinsic gate resistance	$f = 1\text{ MHz}$ open drain	-	5.2	-	Ω
Q_g	Total gate charge	$V_{DD} = 480\text{ V}$, $I_D = 12\text{ A}$, $V_{GS} = 0$ to 10 V (see Figure 15: "Test circuit for blue charge behavior")	-	16.7	-	nC
Q_{gs}	Gate-source charge		-	3.5	-	
Q_{gd}	Gate-drain charge		-	9.4	-	

Notes:

⁽¹⁾ $C_{oss\text{ eq.}}$ is defined as a constant equivalent capacitance giving the same charging time as C_{oss} when V_{DS} increases from 0 to 80% V_{DSS} .

Table 7: Switching times

Symbol	Parameter	Test conditions	Min.	Typ.	Max.	Unit
$t_{d(on)}$	Turn-on delay time	$V_{DD} = 300\text{ V}$, $I_D = 6\text{ A}$ $R_G = 4.7\text{ }\Omega$, $V_{GS} = 10\text{ V}$ (see Figure 14: "Test circuit for resistive load switching times" and Figure 19: "Switching time waveform")	-	13	-	ns
t_r	Rise time		-	7.6	-	
$t_{d(off)}$	Turn-off delay time		-	19.8	-	
t_f	Fall time		-	6.8	-	

Table 8: Source drain diode

Symbol	Parameter	Test conditions	Min.	Typ.	Max.	Unit
I_{SD}	Source-drain current		-		12	A
$I_{SDM}^{(1)}$	Source-drain current (pulsed)		-		32	A
$V_{SD}^{(2)}$	Forward on voltage	$V_{GS} = 0\text{ V}$, $I_{SD} = 12\text{ A}$	-		1.6	V
t_{rr}	Reverse recovery time	$I_{SD} = 12\text{ A}$, $di/dt = 100\text{ A}/\mu\text{s}$, $V_{DD} = 60\text{ V}$ (see Figure 16 : "Test circuit for inductive load switching and diode recovery times")	-	210		ns
Q_{rr}	Reverse recovery charge		-	1.7		μC
I_{RRM}	Reverse recovery current		-	13.8		A
t_{rr}	Reverse recovery time	$I_{SD} = 12\text{ A}$, $di/dt = 100\text{ A}/\mu\text{s}$, $V_{DD} = 60\text{ V}$, $T_j = 150\text{ }^\circ\text{C}$ (see Figure 16 : "Test circuit for inductive load switching and diode recovery times")	-	310		ns
Q_{rr}	Reverse recovery charge		-	3.2		μC
I_{RRM}	Reverse recovery current		-	15.4		A

Notes:

- (1) Pulse width is limited by safe operating area.
(2) Pulse test: pulse duration = 300 μs , duty cycle 1.5%.

2.1 Electrical characteristics (curves)

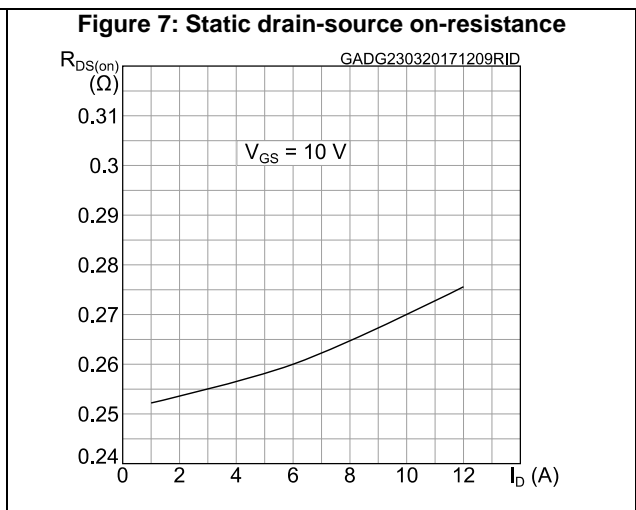
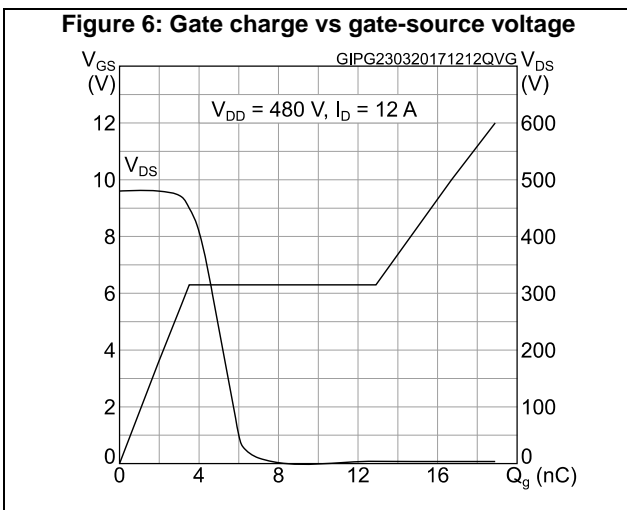
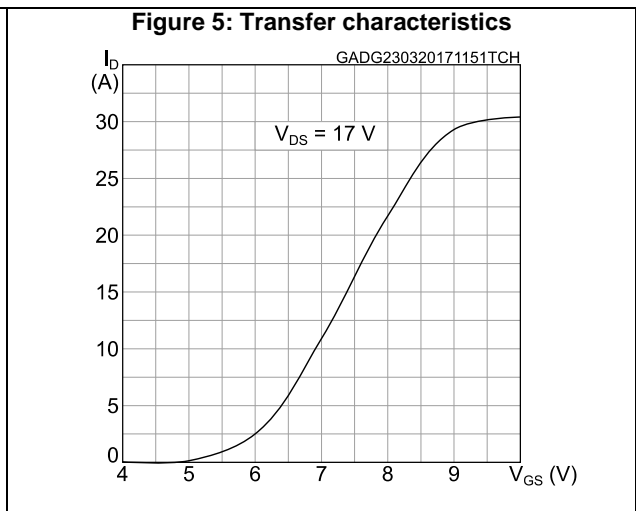
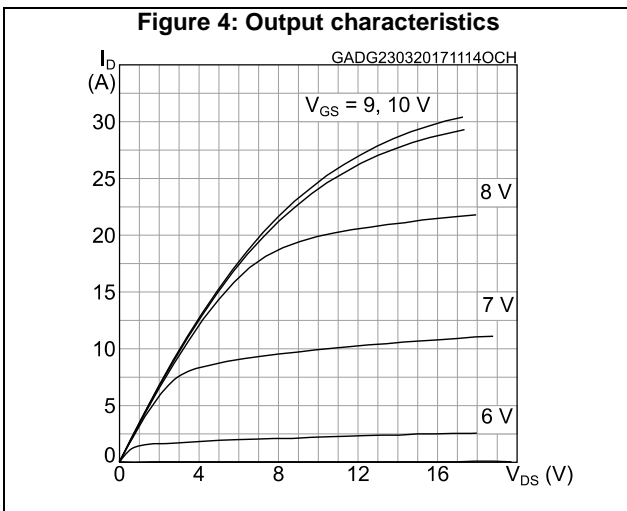
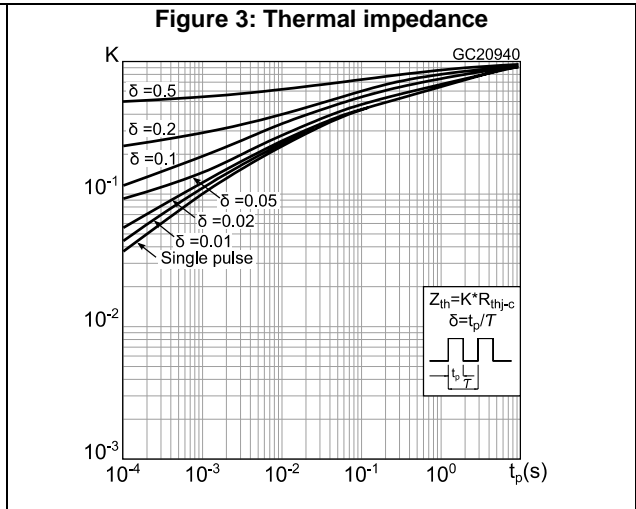
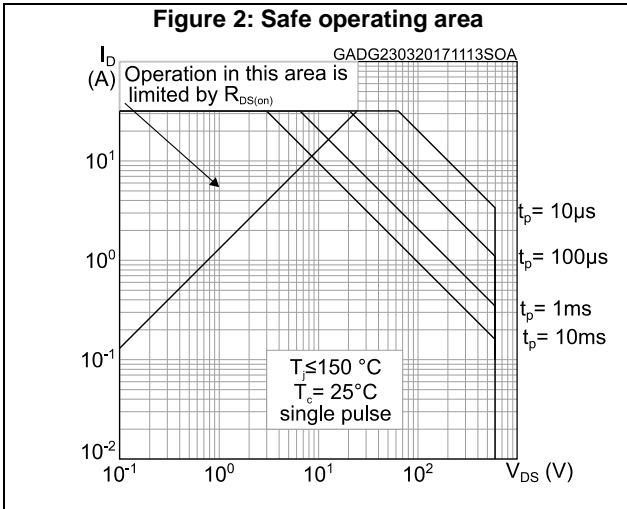

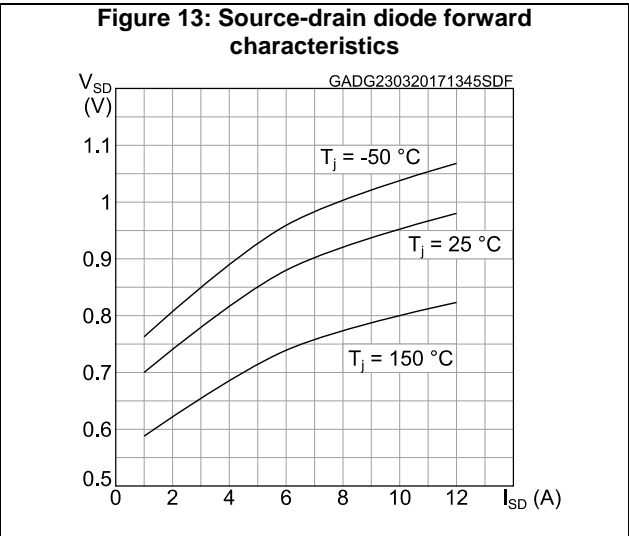
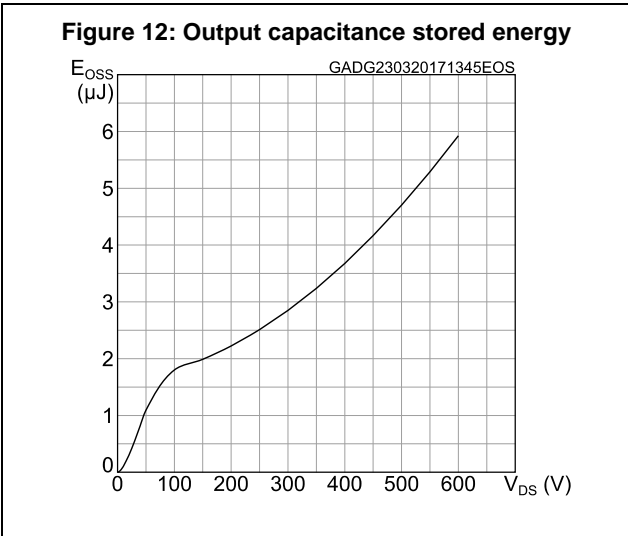
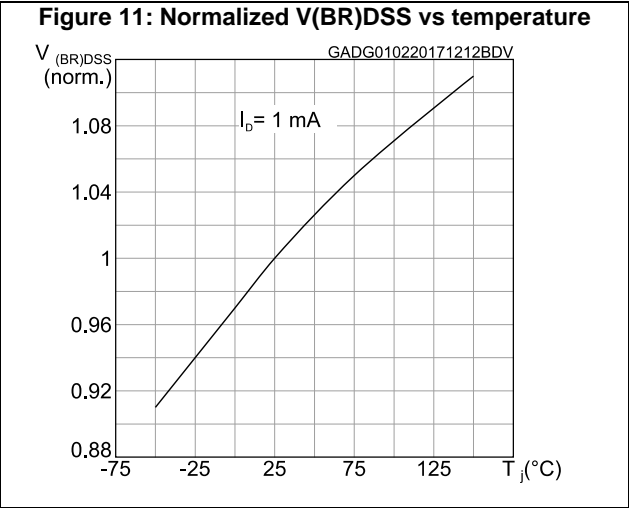
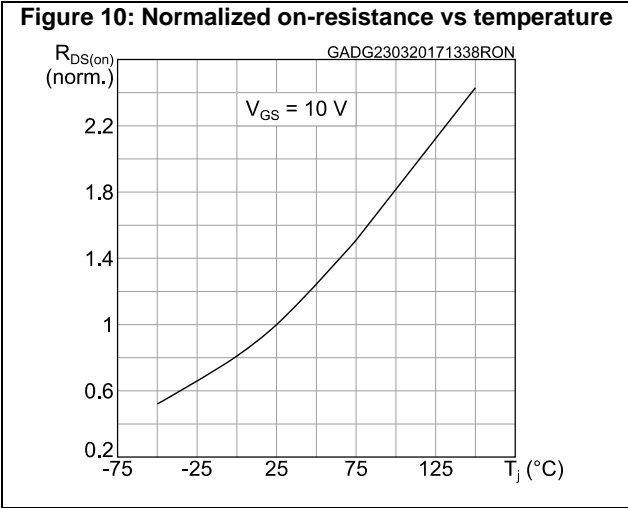
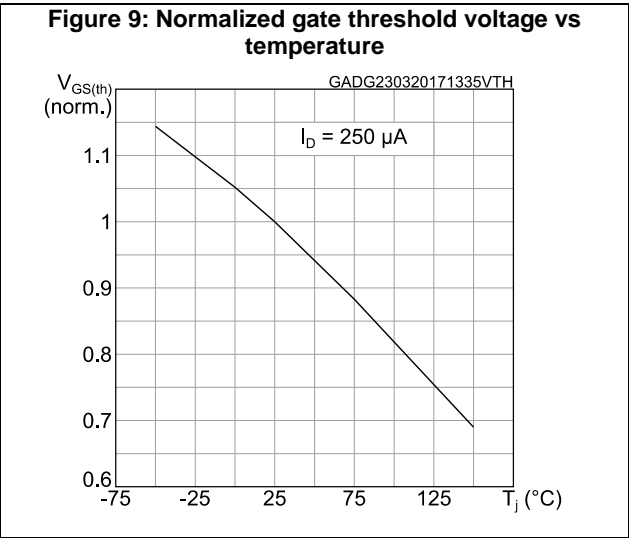
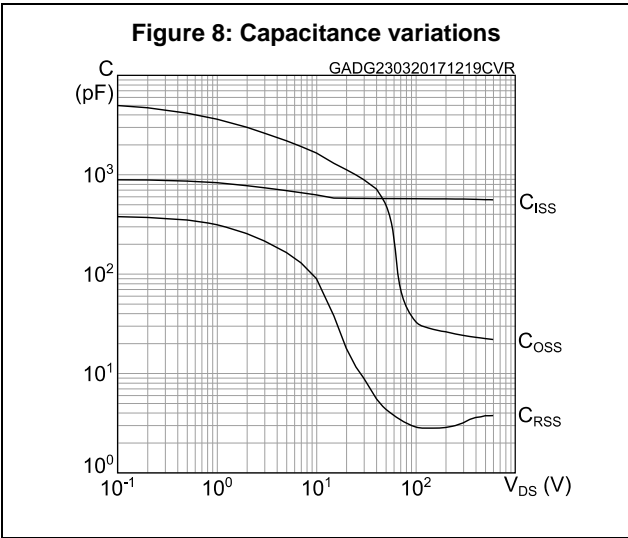

3 Test circuits

Figure 14: Test circuit for resistive load switching times

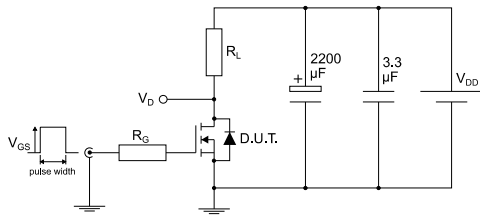

AM01468v1

Figure 15: Test circuit for gate charge behavior



AM01469v1

Figure 16: Test circuit for inductive load switching and diode recovery times

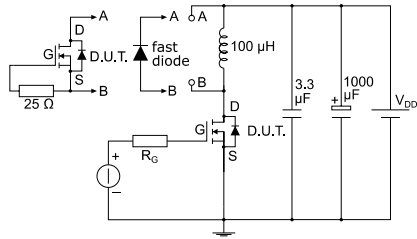

AM01470v1

Figure 17: Unclamped inductive load test circuit

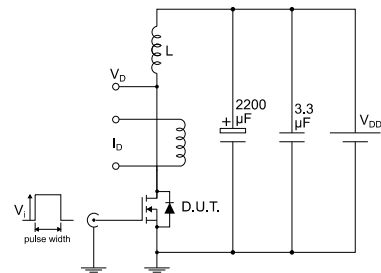

AM01471v1

Figure 18: Unclamped inductive waveform

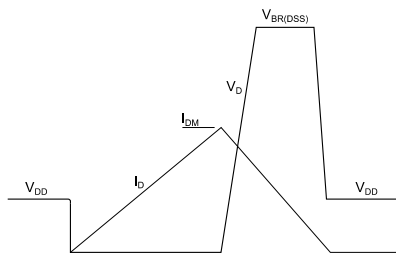

AM01472v1

Figure 19: Switching time waveform

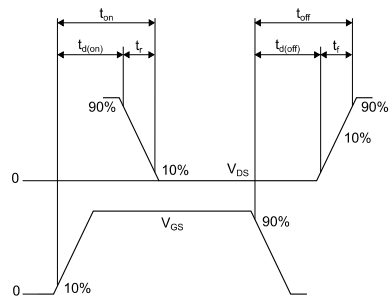

AM01473v1

4 Package information

In order to meet environmental requirements, ST offers these devices in different grades of ECOPACK® packages, depending on their level of environmental compliance. ECOPACK® specifications, grade definitions and product status are available at: www.st.com. ECOPACK® is an ST trademark.

4.1 TO-220FP package information

Figure 20: TO-220FP package outline

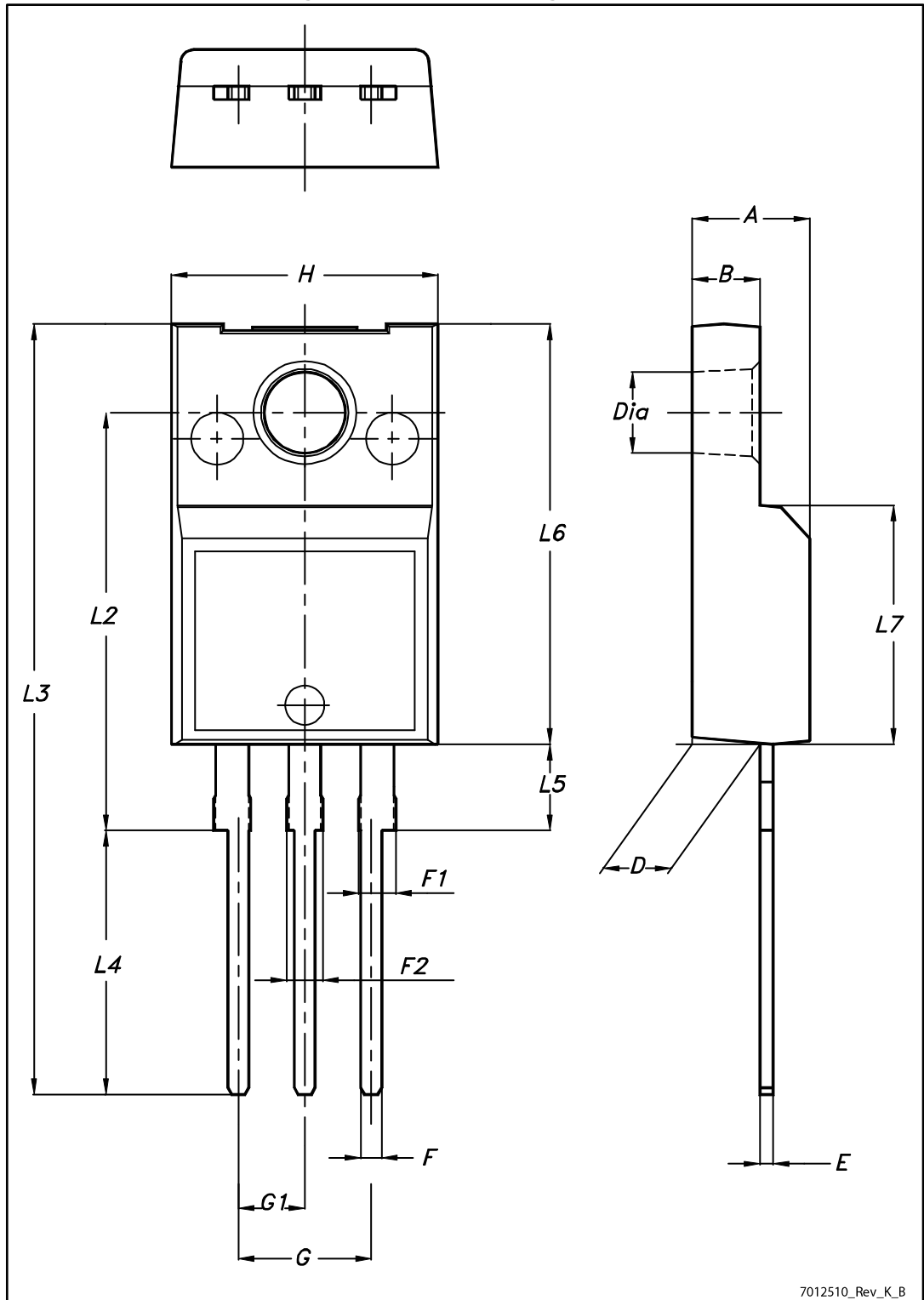

7012510_Rev_K_B

Table 9: TO-220FP package mechanical data

Dim.	mm		
	Min.	Typ.	Max.
A	4.4		4.6
B	2.5		2.7
D	2.5		2.75
E	0.45		0.7
F	0.75		1
F1	1.15		1.70
F2	1.15		1.70
G	4.95		5.2
G1	2.4		2.7
H	10		10.4
L2		16	
L3	28.6		30.6
L4	9.8		10.6
L5	2.9		3.6
L6	15.9		16.4
L7	9		9.3
Dia	3		3.2

5 Revision history

Table 10: Document revision history

Date	Revision	Changes
23-Mar-2017	1	First release.

IMPORTANT NOTICE – PLEASE READ CAREFULLY

STMicroelectronics NV and its subsidiaries ("ST") reserve the right to make changes, corrections, enhancements, modifications, and improvements to ST products and/or to this document at any time without notice. Purchasers should obtain the latest relevant information on ST products before placing orders. ST products are sold pursuant to ST's terms and conditions of sale in place at the time of order acknowledgement.

Purchasers are solely responsible for the choice, selection, and use of ST products and ST assumes no liability for application assistance or the design of Purchasers' products.

No license, express or implied, to any intellectual property right is granted by ST herein.

Resale of ST products with provisions different from the information set forth herein shall void any warranty granted by ST for such product.

ST and the ST logo are trademarks of ST. All other product or service names are the property of their respective owners.

Information in this document supersedes and replaces information previously supplied in any prior versions of this document.

© 2017 STMicroelectronics – All rights reserved



**Стандарт
Электрон
Связь**

Мы молодая и активно развивающаяся компания в области поставок электронных компонентов. Мы поставляем электронные компоненты отечественного и импортного производства напрямую от производителей и с крупнейших складов мира.

Благодаря сотрудничеству с мировыми поставщиками мы осуществляем комплексные и плановые поставки широчайшего спектра электронных компонентов.

Собственная эффективная логистика и склад в обеспечивает надежную поставку продукции в точно указанные сроки по всей России.

Мы осуществляем техническую поддержку нашим клиентам и предпродажную проверку качества продукции. На все поставляемые продукты мы предоставляем гарантию .

Осуществляем поставки продукции под контролем ВП МО РФ на предприятия военно-промышленного комплекса России , а также работаем в рамках 275 ФЗ с открытием отдельных счетов в уполномоченном банке. Система менеджмента качества компании соответствует требованиям ГОСТ ISO 9001.

Минимальные сроки поставки, гибкие цены, неограниченный ассортимент и индивидуальный подход к клиентам являются основой для выстраивания долгосрочного и эффективного сотрудничества с предприятиями радиоэлектронной промышленности, предприятиями ВПК и научно-исследовательскими институтами России.

С нами вы становитесь еще успешнее!

Наши контакты:

Телефон: +7 812 627 14 35

Электронная почта: sales@st-electron.ru

Адрес: 198099, Санкт-Петербург,
Промышленная ул, дом № 19, литера Н,
помещение 100-Н Офис 331