

Analog Devices Welcomes Hittite Microwave Corporation

NO CONTENT ON THE ATTACHED DOCUMENT HAS CHANGED



THIS PAGE INTENTIONALLY LEFT BLANK



HMC506LP4 / 506LP4E

MMIC VCO w/ BUFFER AMPLIFIER, 7.8 - 8.7 GHz

Typical Applications

Low noise MMIC VCO w/Buffer Amplifier for:

- VSAT Radio
- Point to Point/Multipoint Radio
- Test Equipment & Industrial Controls
- Military End-Use

Features

- Pout: +14 dBm
- Phase Noise: -103 dBc/Hz @100 KHz
- No External Resonator Needed
- Single Supply: +3V @ 77 mA
- QFN Leadless SMT Package, 16 mm²

Functional Diagram

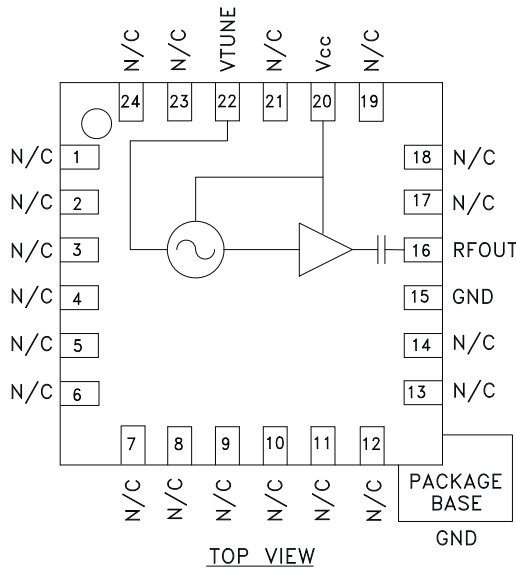

General Description

The HMC506LP4 & HMC506LP4E are GaAs InGaP Heterojunction Bipolar Transistor (HBT) MMIC VCOs with integrated resonators, negative resistance devices, varactor diodes, and buffer amplifiers. Covering 7.8 to 8.7 GHz, the VCO's phase noise performance is excellent over temperature, shock and vibration due to the oscillator's monolithic structure. Power output is +14 dBm typical from a single supply of +3.0V @ 77 mA. The voltage controlled oscillator is packaged in a leadless QFN 4 x 4 mm surface mount package.

Electrical Specifications, $T_A = +25^\circ C$, $V_{cc} = +3V$

| Parameter | Min. | Typ. | Max. | Units |
|----------------------------------------------------------------|------|-----------|------|-----------------|
| Frequency Range | | 7.8 - 8.7 | | GHz |
| Power Output | 11.0 | 14.0 | | dBm |
| SSB Phase Noise @ 100 kHz Offset, $V_{tune} = +5V$ @ RF Output | | -103 | | dBc/Hz |
| Tune Voltage (V_{tune}) | 1 | | 11 | V |
| Supply Current (I_{cc}) ($V_{cc} = +3.0V$) | | 77 | | mA |
| Tune Port Leakage Current | | | 10 | μA |
| Output Return Loss | | 7 | | dB |
| Harmonics | | | | |
| 2nd | | -16 | | dBc |
| 3rd | | -28 | | dBc |
| Pulling (into a 2.0:1 VSWR) | | 28 | | MHz pp |
| Pushing @ $V_{tune} = +5V$ | | 78 | | MHz/V |
| Frequency Drift Rate | | 0.85 | | MHz/ $^\circ C$ |

For price, delivery, and to place orders, please contact Hittite Microwave Corporation:
20 Alpha Road, Chelmsford, MA 01824 Phone: 978-250-3343 Fax: 978-250-3373
Order On-line at www.hittite.com



HMC506LP4 / 506LP4E

MMIC VCO w/ BUFFER AMPLIFIER, 7.8 - 8.7 GHz

Frequency vs. Tuning Voltage, $T = 25^{\circ}\text{C}$

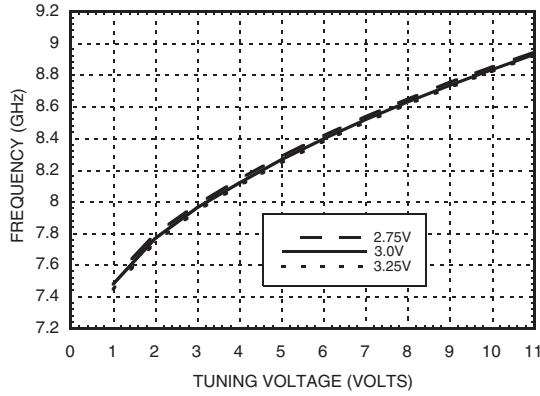

Frequency vs. Tuning Voltage, $V_{cc} = +3V$

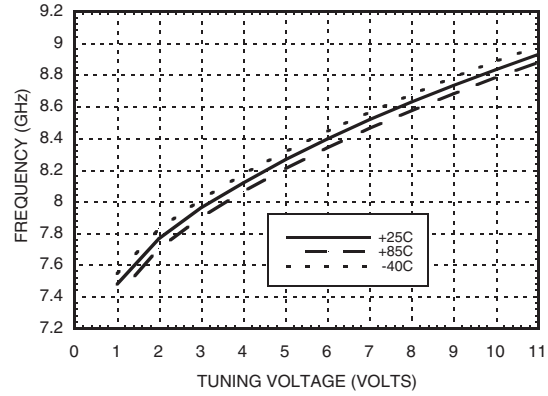

Sensitivity vs. Tuning Voltage, $V_{cc} = +3V$

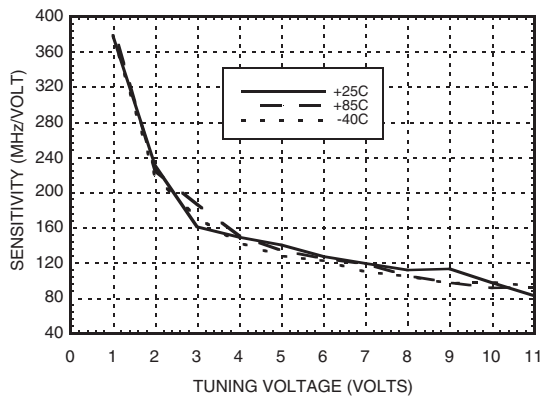

Output Power vs. Tuning Voltage, $V_{cc} = +3V$

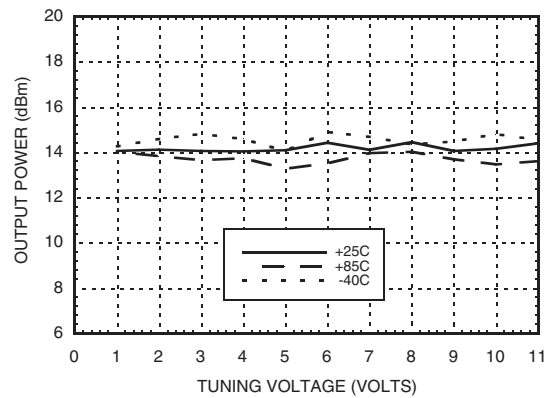

Phase Noise vs. Tuning Voltage

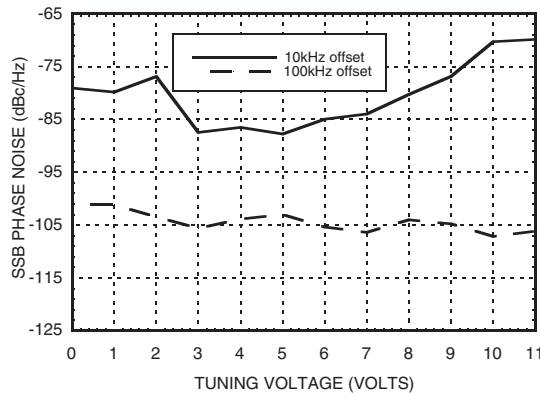

Typical SSB Phase Noise @ $V_{tune} = +5V$

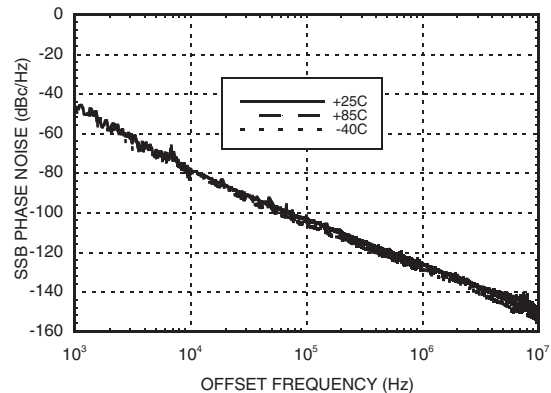

For price, delivery, and to place orders, please contact Hittite Microwave Corporation:
20 Alpha Road, Chelmsford, MA 01824 Phone: 978-250-3343 Fax: 978-250-3373
Order On-line at www.hittite.com

Absolute Maximum Ratings

| | |
|---------------------------------------------------------------------------|----------------|
| Vcc | +3.5 Vdc |
| Vtune | 0 to +11V |
| Channel Temperature | 135 °C |
| Continuous P _{diss} (T = 85°C) (derate 6.07 mW/°C above 85°C) | 303 mW |
| Thermal Resistance (junction to ground paddle) | 165 °C/W |
| Storage Temperature | -65 to +150 °C |
| Operating Temperature | -40 to +85 °C |

Typical Supply Current vs. Vcc

| Vcc (V) | I _{cc} (mA) |
|---------|----------------------|
| 2.75 | 66 |
| 3.0 | 77 |
| 3.25 | 88 |

Note: VCO will operate over full voltage range shown above.



**ELECTROSTATIC SENSITIVE DEVICE
OBSERVE HANDLING PRECAUTIONS**

Outline Drawing

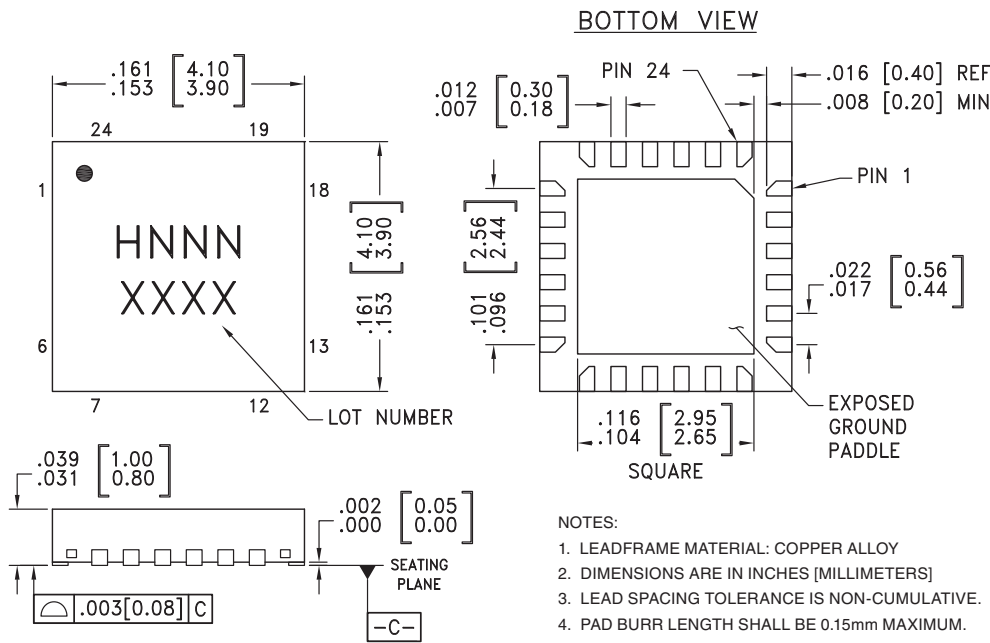

Package Information

| Part Number | Package Body Material | Lead Finish | MSL Rating | Package Marking ^[3] |
|-------------|----------------------------------------------------|---------------|---------------------|--------------------------------|
| HMC506LP4 | Low Stress Injection Molded Plastic | Sn/Pb Solder | MSL1 ^[1] | H506 XXXX |
| HMC506LP4E | RoHS-compliant Low Stress Injection Molded Plastic | 100% matte Sn | MSL1 ^[2] | H506 XXXX |

[1] Max peak reflow temperature of 235 °C



[2] Max peak reflow temperature of 260 °C

[3] 4-Digit lot number XXXX

For price, delivery, and to place orders, please contact Hittite Microwave Corporation:
20 Alpha Road, Chelmsford, MA 01824 Phone: 978-250-3343 Fax: 978-250-3373
Order On-line at www.hittite.com

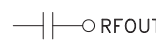
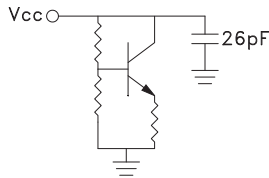
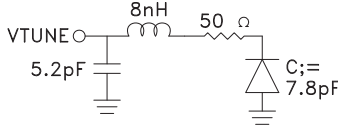

Pin Descriptions

| Pin Number | Function | Description | Interface Schematic |
|-------------------------------|----------|---------------------------------------------------------------------------------------|---------------------------------------------------------------------------------------|
| 1- 14, 17 - 19, 21, 23, 24 | N/C | No Connection | |
| 15 | GND | This pin must be connected to RF & DC ground. |  |
| 16 | RFOUT | RF output (AC coupled) |  |
| 20 | Vcc | Supply Voltage Vcc= 3V |  |
| 22 | VTUNE | Control Voltage Input. Modulation port bandwidth dependent on drive source impedance. |  |
| | GND | Package bottom has an exposed metal paddle that must be RF & DC grounded. |  |

Evaluation PCB

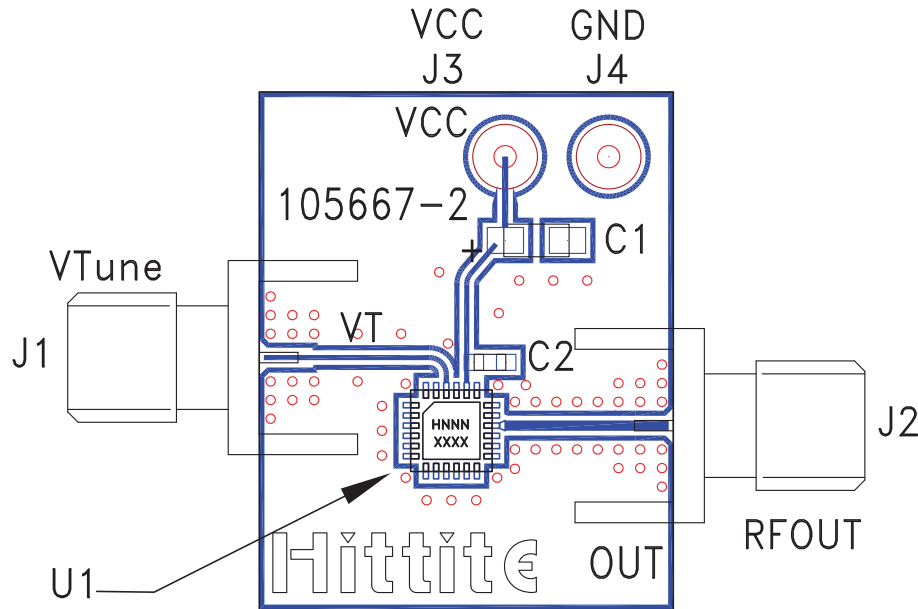

List of Materials for Evaluation PCB 105706 ^[1]

| Item | Description |
|--------------------|--------------------------------|
| J1 - J2 | PCB Mount SMA RF Connector |
| J3 - J4 | DC Pin |
| C1 | 4.7 μ F Tantalum Capacitor |
| C2 | 10,000 pF Capacitor, 0603 Pkg. |
| U1 | HMC506LP4 / HMC506LP4E VCO |
| PCB ^[2] | 105667 Eval Board |

[1] Reference this number when ordering complete evaluation PCB

[2] Circuit Board Material: Rogers 4350

The circuit board used in the final application should use RF circuit design techniques. Signal lines should have 50 ohm impedance while the package ground leads and exposed paddle should be connected directly to the ground plane similar to that shown. A sufficient number of via holes should be used to connect the top and bottom ground planes. The evaluation circuit board shown is available from Hittite upon request.



Notes:



Стандарт Электрон Связь

Мы молодая и активно развивающаяся компания в области поставок электронных компонентов. Мы поставляем электронные компоненты отечественного и импортного производства напрямую от производителей и с крупнейших складов мира.

Благодаря сотрудничеству с мировыми поставщиками мы осуществляем комплексные и плановые поставки широчайшего спектра электронных компонентов.

Собственная эффективная логистика и склад в обеспечивает надежную поставку продукции в точно указанные сроки по всей России.

Мы осуществляем техническую поддержку нашим клиентам и предпродажную проверку качества продукции. На все поставляемые продукты мы предоставляем гарантию .

Осуществляем поставки продукции под контролем ВП МО РФ на предприятия военно-промышленного комплекса России , а также работаем в рамках 275 ФЗ с открытием отдельных счетов в уполномоченном банке. Система менеджмента качества компании соответствует требованиям ГОСТ ISO 9001.

Минимальные сроки поставки, гибкие цены, неограниченный ассортимент и индивидуальный подход к клиентам являются основой для выстраивания долгосрочного и эффективного сотрудничества с предприятиями радиоэлектронной промышленности, предприятиями ВПК и научно-исследовательскими институтами России.

С нами вы становитесь еще успешнее!

Наши контакты:

Телефон: +7 812 627 14 35

Электронная почта: sales@st-electron.ru

Адрес: 198099, Санкт-Петербург,
Промышленная ул, дом № 19, литера Н,
помещение 100-Н Офис 331