

POWER MANAGEMENT

Features

- Input voltage protection — 30V
- Single input charger
- Constant voltage — 4.2V, 1% regulation
- Charging by current and voltage regulation (CC/CV)
- Thermal limiting of charge current
- Programmable fast-charge current
- Current-limited adapter support — reduces power dissipation in charger IC
- Instantaneous CC-to-CV transition for faster charging
- Three termination options — float-charge, automatic re-charge, or forced re-charge to keep the battery topped-off after termination without float-charging
- Soft-start reduces adapter load transients
- High operating voltage range permits use of unregulated adapters
- Complies with CCSA YD/T 1591-2006
- Space saving 2x2x0.6 (mm) MLPD package
- Pb free, Halogen free, and RoHS/WEEE compliant

Applications

- Mobile phones
- MP3 players
- GPS handheld receivers

Description

The SC810 is a linear single-cell Li-ion battery charger in a 6 lead 2x2mm MLPD Ultra-thin package. The input will survive sustained input voltage up to 30V to protect against hot plug overshoot and faulty charging adapters.

Charging begins automatically when a valid input source is applied. Thermal limiting protects the SC810 from excessive power dissipation. It can be programmed to turn off when charging is complete or to continue operating as an LDO regulator while float-charging the battery.

The input will charge with an adapter operating in voltage regulation or in current-limit to obtain the lowest possible power dissipation by pulling the input voltage down to the battery voltage. The maximum fast-charge current setting is 1A.

Charge current is programmed with a single resistor. Pre-charge and termination current are fixed at 20% and 10%, respectively, of the programmed fast-charge current. Charge current steps up to the programmed value (soft starts) to reduce load transients on the charging adapter.

Typical Application Circuit

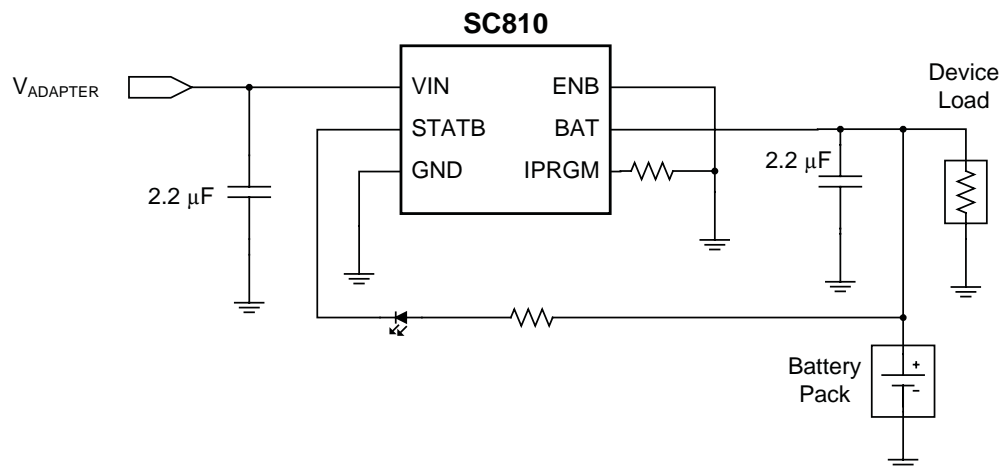

Pin Configuration

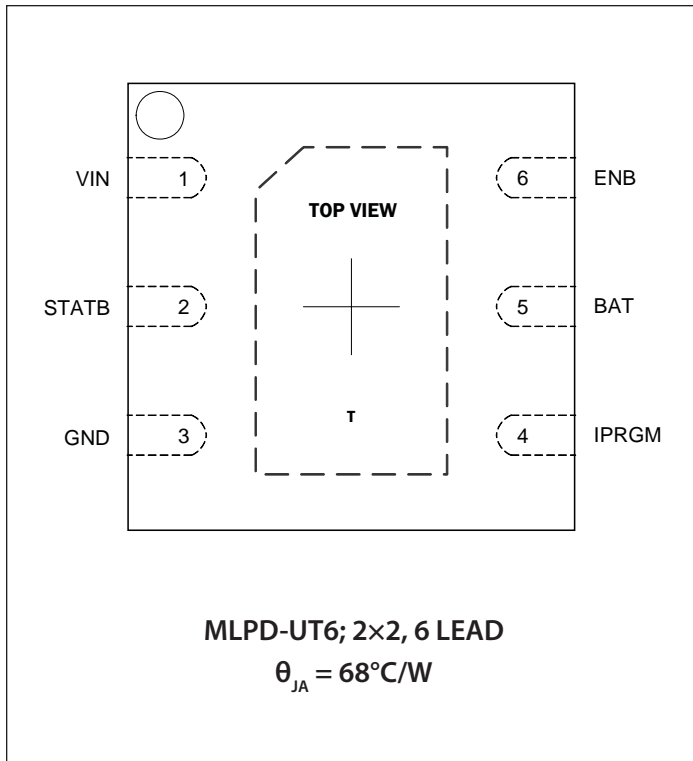

Ordering Information

Device	Package
SC810ULTRT ⁽¹⁾⁽²⁾	MLPD-UT-6 2x2
SC810EVB	Evaluation Board

Notes:

- (1) Available in tape and reel only. A reel contains 3,000 devices.
- (2) Pb free, halogen free, and RoHS/WEEE compliant.

Marking Information

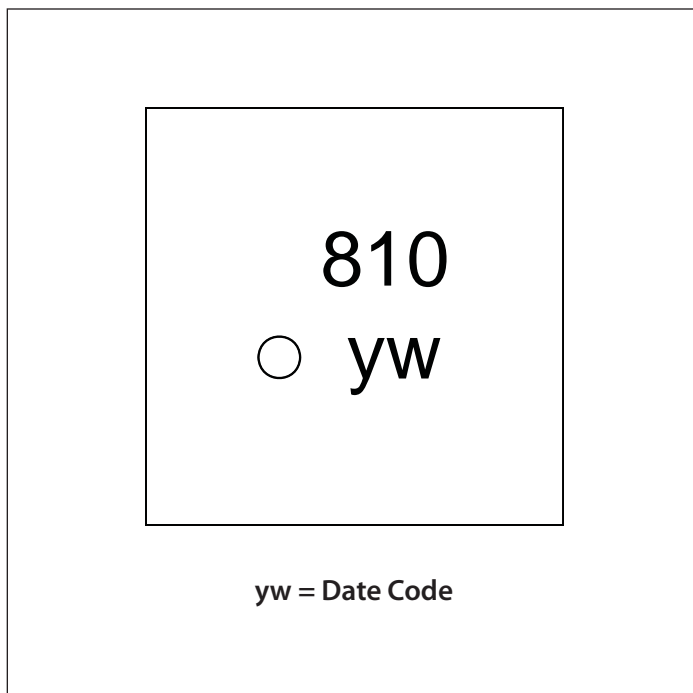

Absolute Maximum Ratings

VIN (V)	-0.3 to +30.0
BAT, IPRGM (V).....	-0.3 to +6.5
STATB, ENB (V)	-0.3 to $V_{BAT} + 0.3$
VIN Input Current (A).....	1.5
BAT, IPRGM Short-to-Duration	Continuous
ESD Protection Level ⁽¹⁾ (kV)	2

Recommended Operating Conditions

Operating Ambient Temperature (°C)	-40 to +85
VIN Operating Voltage ⁽²⁾ (V)	4.60 to 8.20

Thermal Information

Thermal Resistance, Junction to Ambient ⁽³⁾ (°C/W).....	68
Maximum Junction Temperature (°C)	+150
Storage Temperature Range (°C)	-65 to +150
Peak IR Reflow Temperature (10s to 30s) (°C).....	+260

Exceeding the above specifications may result in permanent damage to the device or device malfunction. Operation outside of the parameters specified in the Electrical Characteristics section is not recommended.

NOTES:

- (1) Tested according to JEDEC standard JESD22-A114D.
- (2) This is the input voltage at which the charger is guaranteed to begin operation. This range, $V_{T_{UVLO-R}}$ Max to V_{OVP-F} Min, applies to charging sources operating in voltage regulation. Charging sources operating in current limit may be pulled below this range by the charging load. Maximum operating voltage is the maximum V_{supply} as defined in EIA/JEDEC Standard No. 78, paragraph 2.11.
- (3) Calculated from package in still air, mounted to 3 x 4.5 (in), 4 layer FR4 PCB with thermal vias under the exposed pad per JESD51 standards.

Electrical Characteristics

Test Conditions: $V_{VIN} = 4.75V$ to $5.25V$; $C_{VIN} = C_{BAT} = 2.2\mu F$; $V_{BAT} = 3.7V$; Typ values at $25^\circ C$; Min and Max at $-40^\circ C < T_A < 85^\circ C$, unless specified.

Parameter	Symbol	Conditions	Min	Typ	Max	Units
VIN Under-Voltage Lockout Rising Threshold	$V_{T_{UVLO-R}}$		4.30	4.45	4.60	V
VIN Under-Voltage Lockout Falling Threshold ⁽¹⁾	$V_{T_{UVLO-F}}$	$V_{VIN} > V_{BAT}$	2.70	2.85	3.00	V
VIN OVP Rising Threshold	$V_{T_{OVP-R}}$				9.6	V
VIN OVP Falling Threshold	$V_{T_{OVP-F}}$		8.2			V
VIN OVP Hysteresis	$V_{T_{OVP-H}}$	$V_{T_{OVP-R}} - V_{T_{OVP-F}}$	50			mV
VIN Charging Disabled Quiescent Current	$I_{q_{VIN_DIS}}$	$V_{ENB} = V_{BAT}$		2	3	mA
VIN Charging Enabled Quiescent Current	$I_{q_{VIN_EN}}$	$V_{ENB} = 0V$, excluding I_{BAT} and I_{IPRGM}		2	3	mA
CV Regulation Voltage	V_{CV}	$I_{BAT} = 50mA$, $-40^\circ C \leq T_J \leq 125^\circ C$	4.16	4.20	4.24	V
CV Voltage Load Regulation	V_{CV_LOAD}	Relative to V_{CV} @ $50mA$, $1mA \leq I_{BAT} \leq 1A$, $-40^\circ C \leq T_J \leq 125^\circ C$	-20		10	mV
Battery Leakage Current	I_{BAT_VO}	$V_{VIN} = 0V$		0.1	1	μA
	I_{BAT_DIS}	$V_{VIN} = 5V$, $V_{ENB} = 2V$		0.1	1	μA
	I_{BAT_MON}	$V_{VIN} = 5V$, $V_{BAT} = V_{CV}$, ENB not connected		0.1	1	μA

Electrical Characteristics (continued)

Parameter	Symbol	Conditions	Min	Typ	Max	Units
Re-charge Threshold	$V_{T_{ReQ}}$	$V_{CV} - V_{BAT}$	60	100	140	mV
Pre-charge Threshold (rising)	$V_{T_{PreQ}}$		2.85	2.90	2.95	V
IPRGM Programming Resistor	R_{IPRGM}		2.05		29.4	k Ω
Fast-Charge Current, adapter mode	I_{FQ_AD}	$R_{IPRGM} = 2.94k\Omega, V_{T_{PreQ}} < V_{BAT} < V_{CV}$	643	694	745	mA
Pre-Charge Current	I_{PreQ}	$R_{IPRGM} = 2.94k\Omega, 1.8V < V_{BAT} < V_{T_{PreQ}}$	105	139	173	mA
Termination Current	I_{TERM}	$R_{IPRGM} = 2.94k\Omega, V_{BAT} = V_{CV}$	59	69	80	mA
Dropout Voltage	V_{DO}	$I_{BAT} = 700mA, 0^\circ C \leq T_J \leq 125^\circ C$		0.40	0.60	V
IPRGM Fast-charge Regulated Voltage	V_{IPRGM_FQ}	$V_{VIN} = 5.0V, V_{T_{PreQ}} < V_{BAT} < V_{CV}$		2.04		V
IPRGM Pre-charge Regulated Voltage	V_{IPRGM_PQ}	$1.8V < V_{BAT} < V_{T_{PreQ}}$		0.408		V
IPRGM Termination Threshold Voltage	$V_{T_{IPRGM_TERM}}$	$V_{BAT} = V_{CV}$ (either input selected)		0.204		V
Thermal Limiting Threshold Temperature	T_{TL}			130		$^\circ C$
Thermal Limiting Rate	i_T	$T_J > T_{TL}$		-50		mA/ $^\circ C$
ENB Input High Voltage	V_{IH}		1.6			V
ENB Input Mid Voltage	V_{IM}		0.7		1.3	V
ENB Input Low Voltage	V_{IL}				0.3	V
ENB Input High-range Threshold Input Current	I_{IH_TH}	ENB current required to pull ENB from floating midrange into high range		23	50	μA
ENB Input High-range Sustain Input Current	I_{IH_SUS}	Current required to hold ENB in high range, $Min V_{IH} \leq V_{ENB} \leq V_{BAT}$ $Min V_{IH} \leq V_{BAT} \leq 4.2V$		0.3	1	μA
ENB Input Mid-range Load Limit	I_{IM}	Input will float to mid range when this load limit is observed.	-5		5	μA
ENB Input Low-range Input Current	I_{IL}	$0V \leq V_{ENB} \leq Max V_{IL}$	-25	-12		μA
ENB Input Leakage	I_{ILEAK}	$V_{VIN} = 0V, V_{ENB} = V_{BAT} = 4.2V$			1	μA
STATB Output Low Voltage	V_{STAT_LO}	$I_{STAT_SINK} = 2mA$			0.5	V
STATB Output High Current	I_{STAT_HI}	$V_{STAT} = 5V$			1	μA

Notes:

- (1) Sustained operation to $V_{T_{UVLO-F}} \leq V_{VIN}$ is guaranteed only if a current limited charging source applied to VIN is pulled below $V_{T_{UVLO-R}}$ by the charging load; forced VIN voltage below $V_{T_{UVLO-R}}$ in some cases may result in regulation errors or other unexpected behavior.

Typical Characteristics

CV Line Regulation

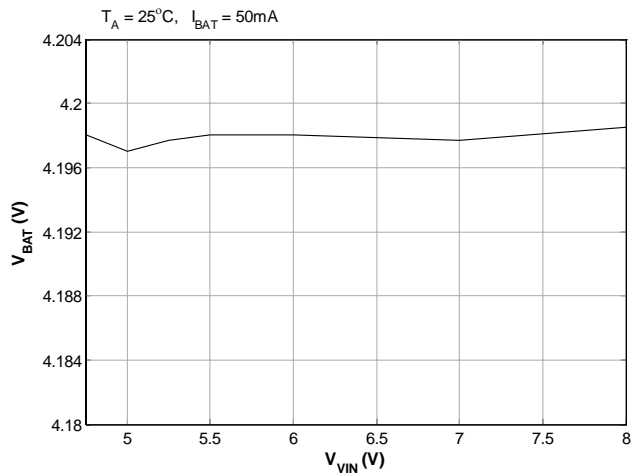

CV Load Regulation

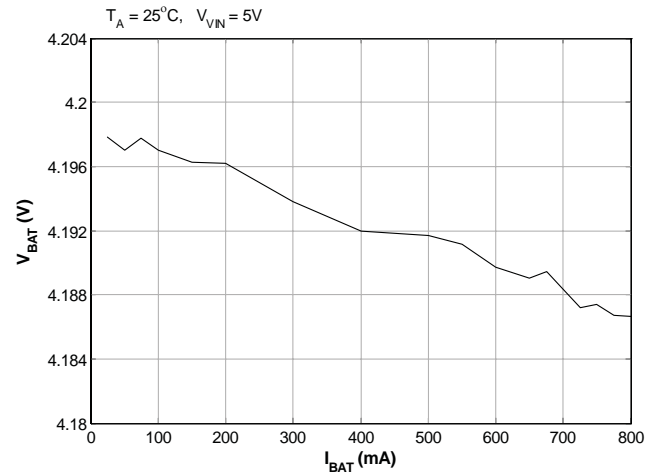

CV Temperature Regulation

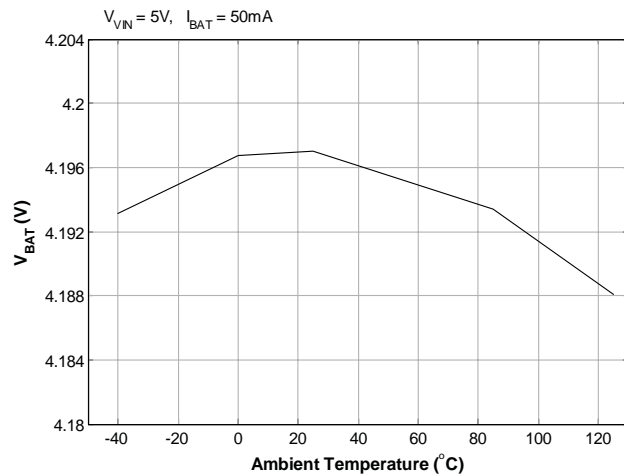

CC FQ Line Regulation

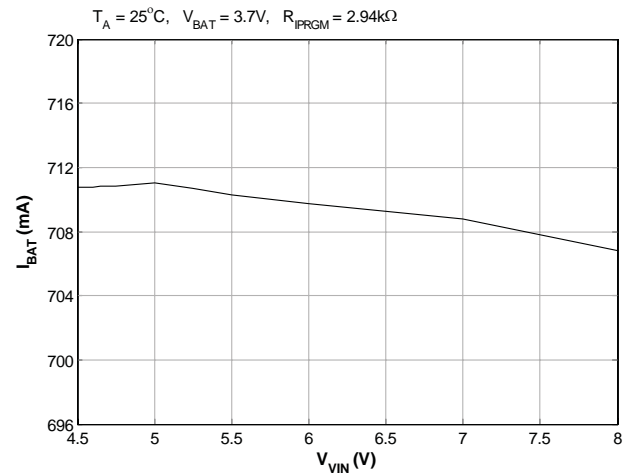

CC FQ V_{BAT} Regulation

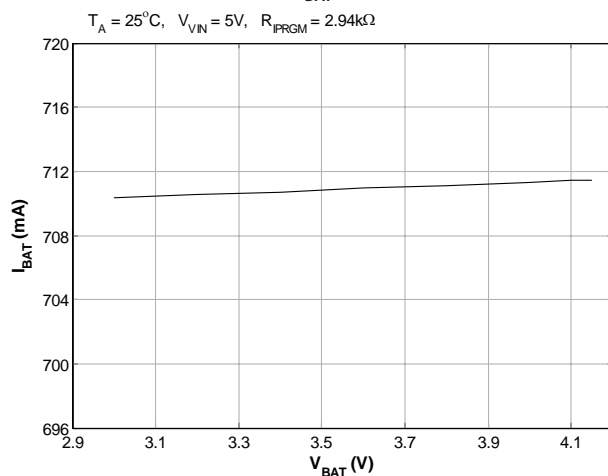

CC FQ Temperature Regulation

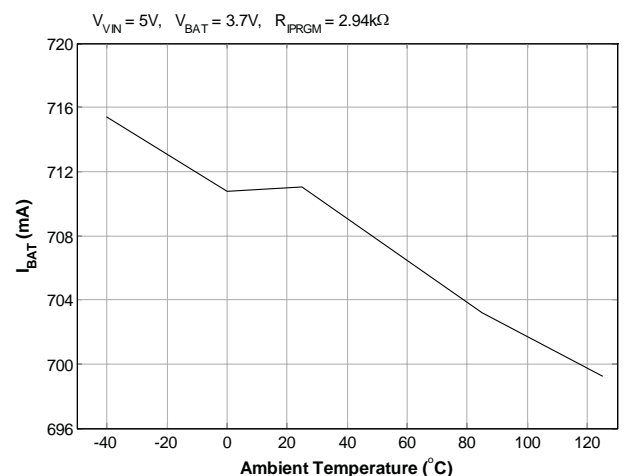

Typical Characteristics (continued)

CC PQ Line Regulation

$T_A = 25^\circ\text{C}$, $V_{\text{BAT}} = 2.6\text{V}$, $R_{\text{IPRGM}} = 2.94\text{k}\Omega$

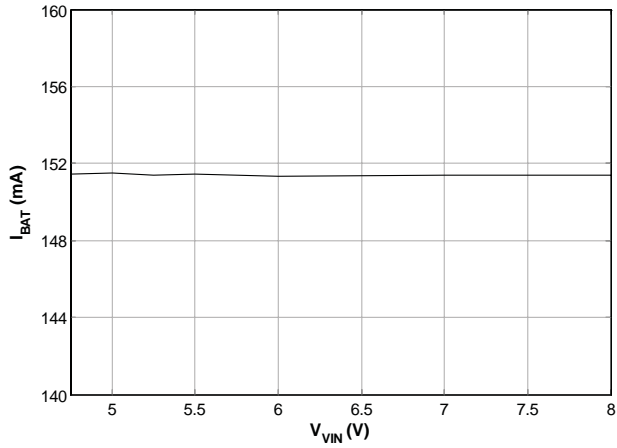

CC PQ Temperature Regulation

$V_{\text{VIN}} = 5\text{V}$, $V_{\text{BAT}} = 2.6\text{V}$, $R_{\text{IPRGM}} = 2.94\text{k}\Omega$

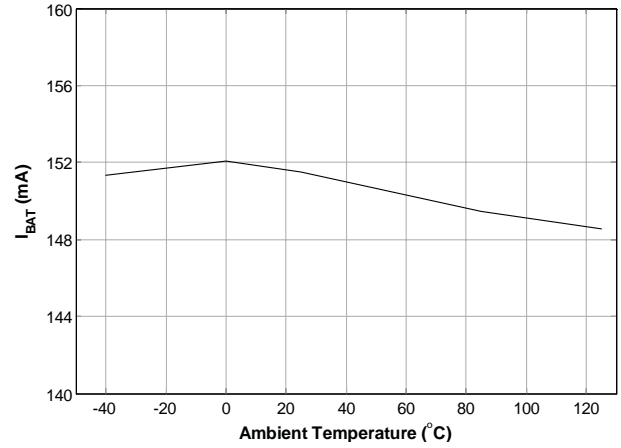

I_{FQ} vs. R_{IPRGM}

$V_{\text{VIN}} = 5\text{V}$, $V_{\text{BAT}} = 3.7\text{V}$, $T_A = 25^\circ\text{C}$

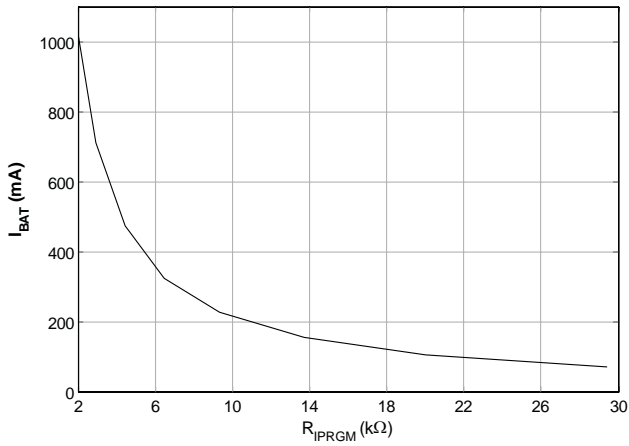

I_{PQ} vs. R_{IPRGM}

$V_{\text{VIN}} = 5\text{V}$, $V_{\text{BAT}} = 2.6\text{V}$, $T_A = 25^\circ\text{C}$

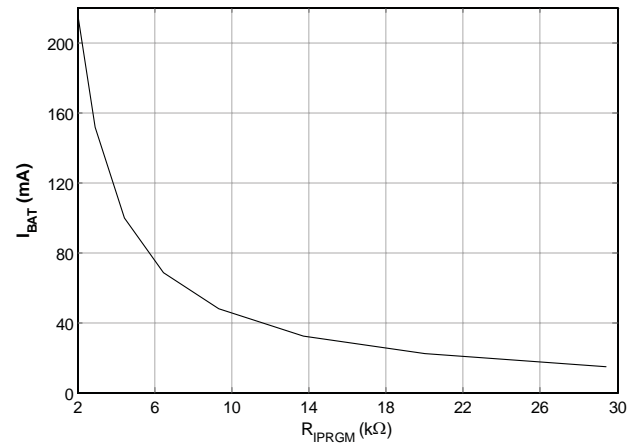

Typical Characteristics (continued)

Charging Cycle Battery Voltage and Current

850mAh battery, $R_{IPRGM} = 2.94k\Omega$, $V_{VIN} = 5.0V$, $T_A = 25^\circ C$

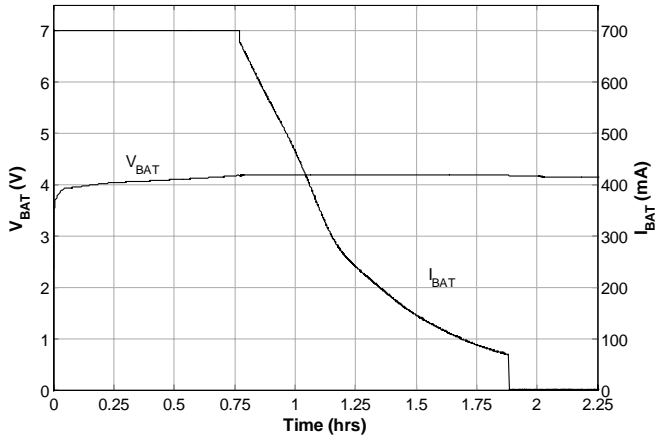

Pre-Charging Battery Voltage and Current

850mAh battery, $R_{IPRGM} = 2.94k\Omega$, $V_{VIN} = 5.0V$, $T_A = 25^\circ C$

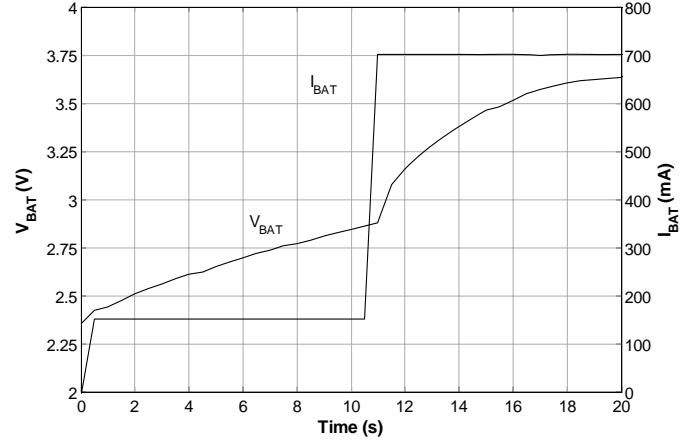

CC-to-CV Battery Voltage and Current

850mAh battery, $R_{IPRGM} = 2.94k\Omega$, $V_{VIN} = 5.0V$, $T_A = 25^\circ C$

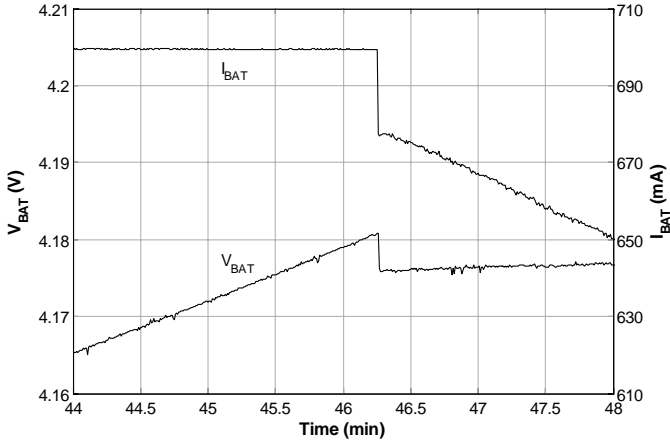

Re-Charge Cycle Battery Voltage and Current

850mAh battery, $R_{IPRGM} = 2.94k\Omega$, $V_{VIN} = 5.0V$, Load = 10mA

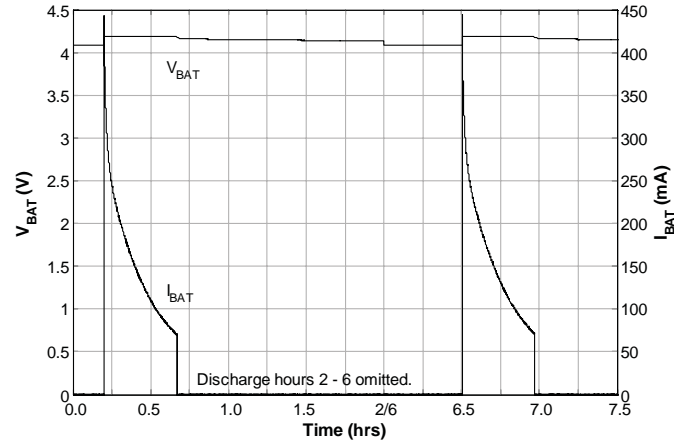

Pin Descriptions

Pin #	Pin Name	Pin Function
1	VIN	Supply pin — connect to charging adapter (wall adapter or USB). This is a high voltage (30V) pin.
2	STATB	Status output pin — This open-drain pin is asserted (pulled low) when a valid charging supply is connected to VIN, and a charging cycle begins. It is released when the termination current is reached, indicating that charging is complete. STATB is not asserted for re-charge cycles.
3	GND	Ground
4	IPRGM	Fast-charge and pre-charge current programming pin — Fast-charge current is programmed by connecting a resistor from this pin to ground. Pre-charge current is 20% of fast-charge current. The charging termination threshold current is 10% of the IPRGM programmed fast-charge current.
5	BAT	Charger output — connect to battery positive terminal.
6	ENB	Combined device enable/disable — Logic high disables the device. Connect to GND to enable charging with indefinite float-charging. Float this pin to enable charging without float-charge upon termination. Note that this pin must be grounded if the SC810 is to be operated without a battery connected to BAT.
T	Thermal Pad	Pad is for heat sinking purposes — not connected internally. Connect exposed pad to ground plane using multiple vias.

Block Diagram

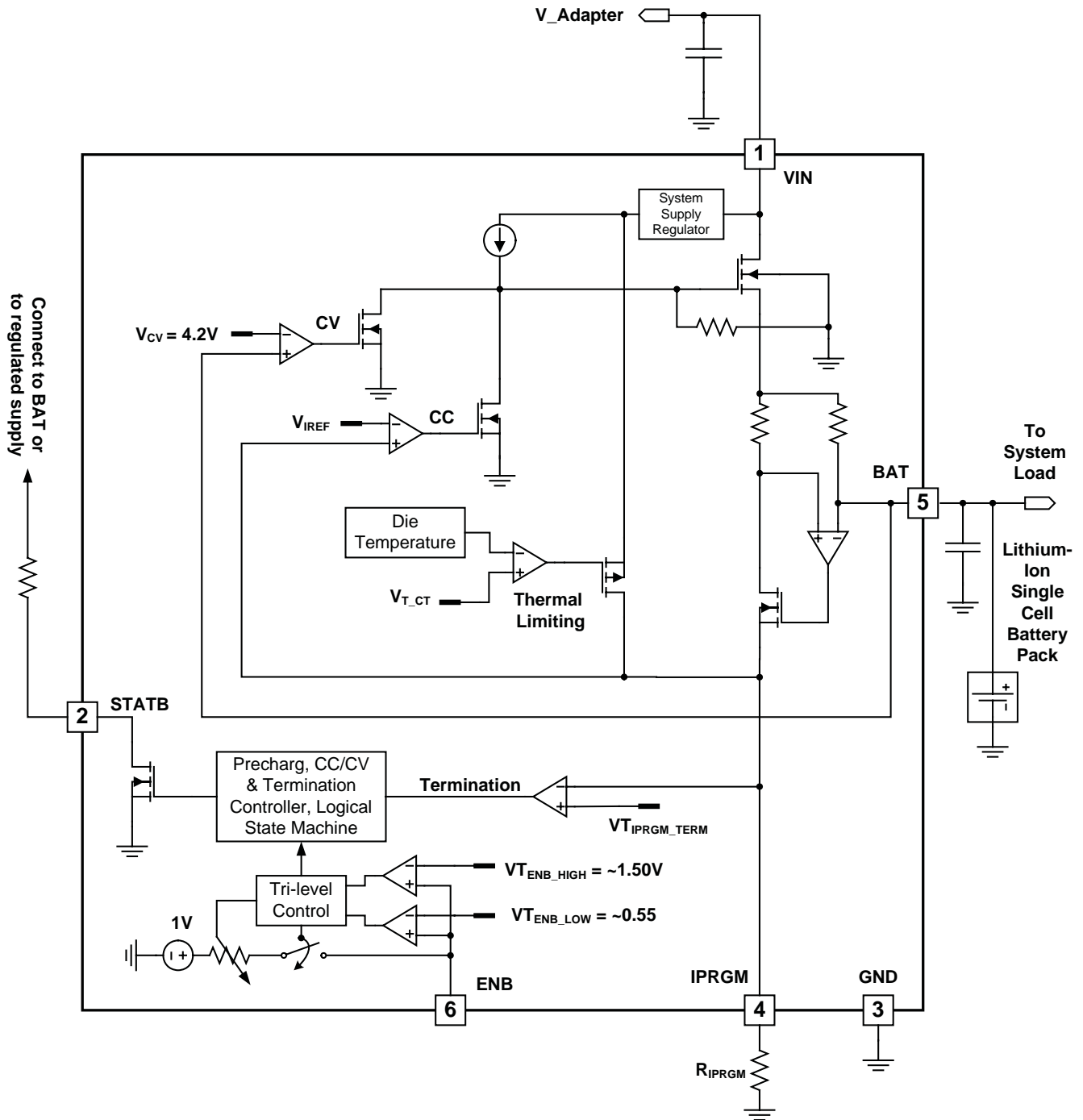

Applications Information

Charger Operation

The SC810 is a single cell Li-ion battery charger. It implements a Constant Current (CC), Constant Voltage (CV) charging algorithm with Thermal Limiting (TL).

When a valid input supply is first detected, a charge cycle is initiated and the STATB open-drain output goes low. If the battery voltage is less than the pre-charge threshold voltage, the pre-charge current is supplied. Pre-charge current is 20% of the programmed fast-charge current.

When the battery voltage exceeds the pre-charge threshold, typically within seconds for a standard battery with a starting cell voltage greater than 2V, the fast-charge CC mode begins. The charge current soft-starts in three steps (20%, 60%, and 100% of programmed fast-charge current) to reduce adapter load transients. CC current is programmed by the IPRGM resistance to ground.

The charger begins CV regulation when the battery voltage rises to the fully-charged single-cell Li-ion regulation voltage (V_{CV}), nominally 4.2V. In CV regulation, the output voltage is regulated, and as the battery charges, the charge current gradually decreases. The STATB output goes high when I_{BAT} drops below the termination threshold current, which is 10% of the IPRGM pin programmed fast-charge current. This is known as charge termination.

Optional Float-charging or Monitoring

Depending on the state of the ENB input, upon termination, the SC810 either operates indefinitely as a voltage regulator (float-charging) or it turns off its output. If the output is turned off upon termination, the device enters the monitor state. In this state, the output remains off until the BAT pin voltage decreases by the re-charge threshold ($V_{ReQ} = 100\text{mV}$ typically). A re-charge cycle then begins automatically and the process repeats. A forced re-charge cycle can also be periodically commanded by the processor to keep the battery topped-off without float-charging. See the Monitor State section for details. Re-charge cycles are not indicated by the STATB pin.

Charging Input Pin Properties

Glitch filtering is performed on the VIN pin, so an input voltage that is ringing across its Under-Voltage Lockout

(UVLO) threshold will not be recognized until the ringing has ceased. The UVLO rising threshold is set higher than the voltage of a fully charged Li-ion single cell battery, ensuring that only a charging source capable of fully charging the battery has been applied. If the charging current loads the adapter beyond its current limit, the input voltage will be pulled down to just above the battery voltage. This is referred to as Current-Limited-Adapter (CLA) operation. The UVLO falling threshold is set close to the battery voltage pre-charge threshold to permit low-dissipation charging from a current limited adapter.

Constant Current Mode Fast-charge Current Programming

The CC mode is active when the battery voltage is above $V_{T_{PreQ}}$ and less than V_{CV} . The programmed CC regulation fast-charge (FQ) current is inversely proportional to the resistance between IPRGM and GND according to the equation

$$I_{FQ} = \frac{V_{IPRGM_Typ}}{R_{IPRGM}} \times 1000$$

The fast-charge current can be programmed for a minimum of 70mA ($R_{IPRGM} = 29.4\text{k}\Omega$) and a maximum of 995mA ($R_{IPRGM} = 2.05\text{k}\Omega$), nominally.

Current regulation accuracy is dominated by gain error at high current settings, and offset error at low current settings. The range of expected fast-charge output current versus programming resistance is shown in Figures 1a and 1b. The figures show the nominal current versus nominal R_{IPRGM} resistance as the center plot and two theoretical limit plots indicating maximum and minimum current versus nominal programming resistance. These plots are derived from models of the expected worst-case contribution of error sources depending on programmed current. The current range includes the uncertainty due to 1% tolerance resistors. The dots on each plot indicate the currents obtained with the Electronic Industries Association (EIA) E96 standard value 1% tolerance resistors. Figures 1a and 1b show low and high resistance ranges, respectively.

Applications Information (continued)

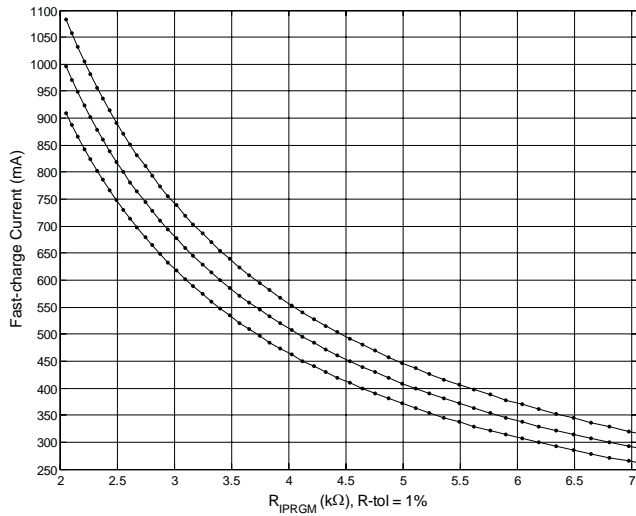

Figure 1a — Fast-charge Current Tolerance versus Programming Resistance, Low Resistance Range

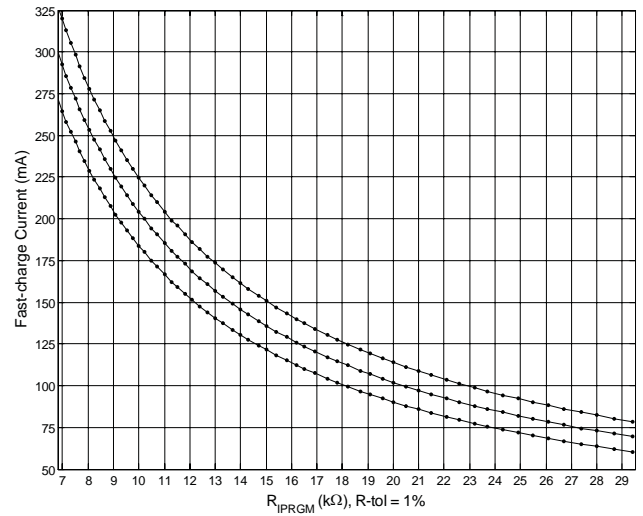

Figure 1b — Fast-charge Current Tolerance versus Programming Resistance, High Resistance Range

Pre-charge Mode

This mode is automatically enabled when the battery voltage is below the pre-charge threshold voltage ($V_{T_{PreQ}}$), typically 2.9V. Pre-charge current conditions the battery for fast charging. The pre-charge current value is fixed at 20% nominally of the fast-charge current for the selected input, as programmed by the resistance between IPRGM and GND.

Pre-charge current regulation accuracy is dominated by offset error. The range of expected pre-charge output

current versus programming resistance is shown in Figures 2a and 2b. The figures show the nominal pre-charge current versus nominal R_{IPRGM} resistance as the center plot and two theoretical limit plots indicating maximum and minimum current versus nominal programming resistance. These plots are derived from models of the expected worst-case contribution of error sources depending on programmed current. The current range includes the uncertainty due to 1% tolerance resistors. The dots on each plot indicate the currents obtained with the EIA E96 standard value 1% tolerance resistors.

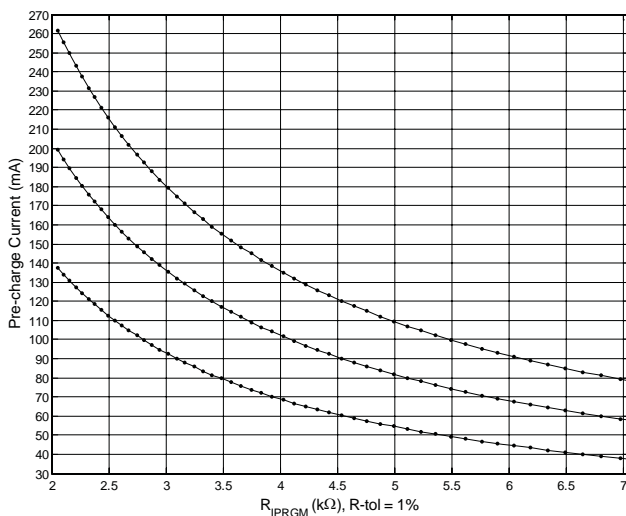

Figure 2a — Pre-charge Current Tolerance versus Programming Resistance, Low Resistance Range

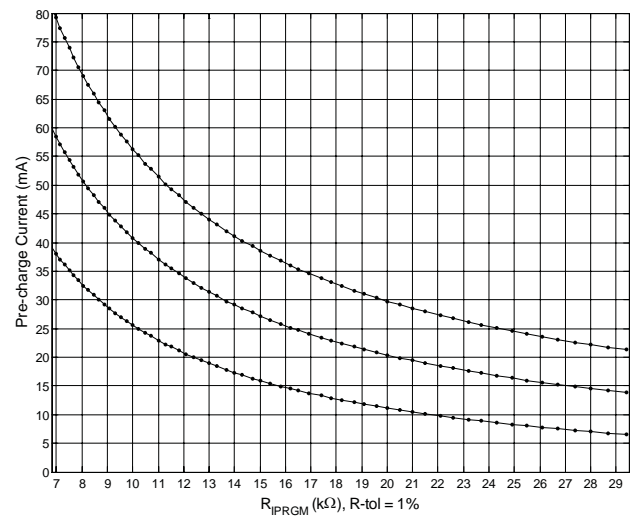

Figure 2b — Pre-charge Current Tolerance versus Programming Resistance, High Resistance Range

Applications Information (continued)

Figures 2a and 2b show low and high resistance ranges, respectively.

Termination

When the battery voltage reaches V_{CV} , the SC810 transitions from constant current regulation to constant voltage regulation. While V_{BAT} is regulated to V_{CV} , the current into the battery decreases as the battery becomes fully charged. When the output current drops below the termination threshold current, fixed at 10% of the programmed fast-charge current, charging terminates. Upon termination, the STATB pin open drain output turns off and the charger either enters monitor state or float-charges the battery, depending on the logical state of the ENB input pin.

Charger output current is the sum of the battery charge current and the system load current. Battery charge current changes gradually, and establishes a slowly diminishing lower bound on the output current while charging in CV mode. The load current into a typical digital system is highly transient in nature. Charge cycle termination is detected when the sum of the battery charging current and the greatest load current occurring within the immediate 300 μ s to 550 μ s past interval is less than the programmed termination current. This timing behavior permits charge cycle termination to occur during a brief low-load-current interval, and does not require that the longer interval average load current be small.

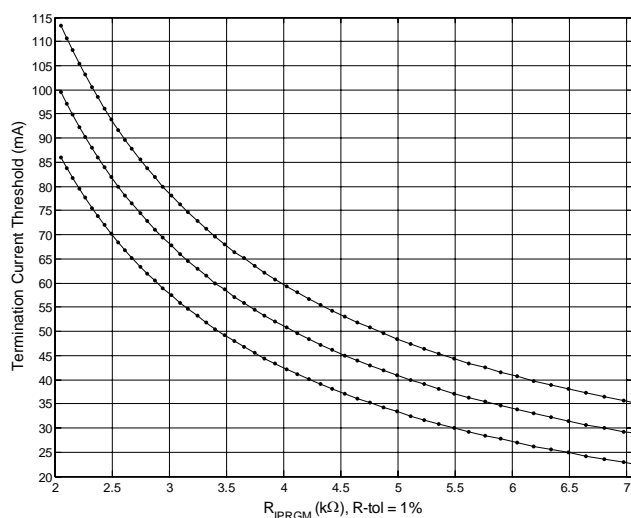

Figure 3a — Termination Current Tolerance versus Programming Resistance, Low Resistance Range

Termination threshold current accuracy is dominated by offset error. The range of expected termination current versus programming resistance is shown in Figures 3a and 3b. The figures show the nominal termination current versus nominal R_{IPRGM} resistance as the center plot and two theoretical limit plots indicating maximum and minimum current versus nominal programming resistance. These plots are derived from models of the expected worst-case contribution of error sources depending on programmed current. The current range includes the uncertainty due to a 1% tolerance resistor. The dots on each plot indicate the currents obtained with the EIA E96 standard value 1% tolerance resistors. Figures 3a and 3b show low and high resistance ranges, respectively.

Enable Input

The ENB pin is a tri-level logical input that allows selection of the following behaviors:

- charging enabled with float-charging after termination (ENB = low range)
- charging enabled with float-charging disabled and battery monitoring at termination (ENB = mid range)
- charging disabled (ENB = high range).

The ENB pin is designed to interface to a processor GPIO port powered from a peripheral supply voltage as low as

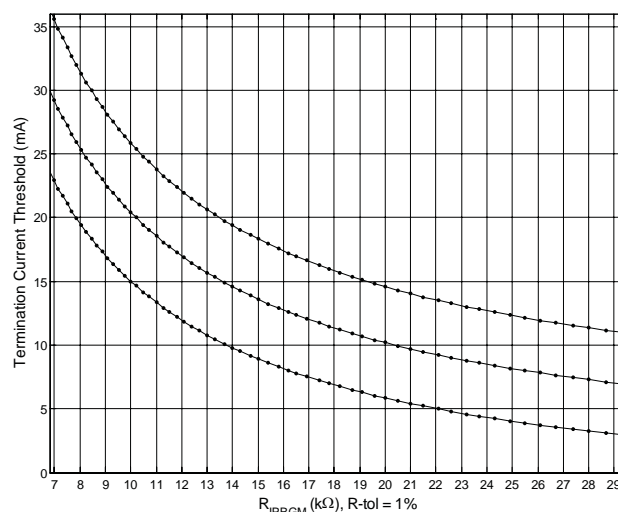

Figure 3b — Termination Current Tolerance versus Programming Resistance, High Resistance Range

Applications Information (continued)

1.8V or as high as a fully charged battery. While a connected GPIO port is configured as an output, the processor writes 0 to select ENB low-range, and 1 to select high-range. The GPIO port is configured as an input to select mid-range.

ENB can also be permanently grounded to select low-range or left unconnected to select mid-range if it will not be necessary to change the level selection.

The equivalent circuit looking into the ENB pin is a variable resistance, minimum 15k Ω , to an approximately 1V source. The input will float to mid range whenever the external driver sinks or sources less than 5 μ A, a common worst-case characteristic of a high impedance or a weak pull-up or pull-down GPIO configured as an input. The driving GPIO must be able to sink at least 25 μ A or source at least 50 μ A to ensure a low or high state, respectively. (See the Electrical Characteristics table.)

With the ENB input voltage permitted to float to mid-range, the charger is enabled but it will turn off its output following charge termination and will enter the monitor state. This state is explained in the next section. Mid-range can be selected either by floating the input (sourcing or sinking less than 5 μ A) or by being externally forced such that V_{ENB} falls within the midrange limits specified in the Electrical Characteristics table.

While driven low ($V_{ENB} < \text{Max } V_{IL}$), the charger is enabled and will continue to float-charge the battery following termination. If the charger is already in monitor state following a previous termination, it will exit the monitor state and begin float-charging.

While ENB is driven high ($V_{ENB} > \text{Min } V_{IH}$), the charger is disabled and the ENB input pin enters a high impedance state, suspending tri-level functionality. The specified high level input current I_{IH} is required only until a high level is recognized by the SC810 internal logic. The tri-level float circuitry is then disabled and the ENB input becomes high impedance. Once forced high, the ENB pin will not float to mid range. To restore tri-level operation, the ENB pin must first be pulled down to mid or low range (at least to $V_{ENB} < \text{Max } V_{IM}$), then, if desired, released (by reconfiguring the GPIO as an input) to select mid-range. If the ENB GPIO has a weak pull-down when configured as an input, then it

is unnecessary to drive ENB low to restore tri-level operation; simply configure the GPIO as an input. When the ENB selection changes from high-range to mid- or low-range, a new charge cycle begins and STATB goes low.

Note that if a GPIO with a weak pull-up input configuration is used, its pull-up current will flow from the GPIO into the ENB pin while it is floating to mid-range. Since the GPIO is driving a 1V equivalent voltage source through a resistance (looking into ENB), this current is small — possibly less than 1 μ A. Nevertheless, this current is drawn from the GPIO peripheral power supply and, therefore, from the battery after termination. See the next section, Monitor State for more information. For this reason, it is preferable that the GPIO chosen to operate the ENB pin should provide a true high impedance (CMOS) configuration or a weak pull-down when configured as an input. When pulled below the float voltage, the ENB pin output current is sourced from VIN (the charging adapter), not from the battery.

Monitor State

If the ENB pin is floating, the charger output and STATB pin will turn off and the device will enter the monitor state when a charge cycle is complete. If the battery voltage falls below the re-charge threshold ($V_{CV} - V_{ReQ}$) while in the monitor state, the charger will automatically initiate a re-charge cycle. The battery leakage current during monitor state is no more than 1 μ A over temperature and typically less than 0.1 μ A at room temperature.

While in the monitor state, the ENB tri-level input pin remains fully active, and although in midrange, is sensitive to both high and low levels. The SC810 can be forced from the monitor state (no float-charging) directly to float-charging operation by driving ENB low. This operation will turn on the charger output, but will not assert the STATB output. If the ENB pin is again allowed to float to mid-range, the charger will remain on only until the output current becomes less than the termination current, and charging terminates. The SC810 turns off its charging output and returns to the monitor state within a millisecond. This forced re-charge behavior is useful for periodically testing the battery state-of-charge and topping-off the battery, without float-charging and without requiring the battery to discharge to the automatic re-charge

Applications Information (continued)

voltage. ENB should be held low for at least 1ms to ensure a successful forced re-charge.

Forced re-charge can be requested at any time during the charge cycle, or even with no charging source present, with no detrimental effect on charger operation. This allows the host processor to schedule a forced re-charge at any desired interval, without regard to whether a charge cycle is already in progress, or even whether a charging source is present. Forced re-charge will neither assert nor release the STATB output.

Status Output

The STATB pin is an open-drain output. It is asserted (driven low) as charging begins after a valid charging input is applied and the VIN pin is greater than the input UVLO level and less than the OVP level. STATB is also asserted as charging begins after the ENB input returns to either of the enable voltage ranges (mid or low voltage) from the disable (high voltage) range. STATB is subsequently released when the termination current is reached to indicate end-of-charge, when the ENB input is driven high to disable charging, or when the input voltage is removed. If the battery is already fully charged when a charge cycle is initiated, STATB is asserted, and remains asserted for approximately 750μs before being released. The STATB pin is not asserted for automatic re-charge cycles.

The STATB pin may be connected to an interrupt input to notify a host controller of the charging status or it can be used as an LED driver.

Logical CC-to-CV Transition

The SC810 differs from monolithic linear single cell Li-ion chargers that implement a linear transition from CC to CV regulation. The linear transition method uses two simultaneous feedback signals — output voltage and output current — to the closed-loop controller. When the output voltage is sufficiently below the CV regulation voltage, the influence of the voltage feedback is negligible and the output current is regulated to the desired current. As the battery voltage approaches the CV regulation voltage (4.2V), the voltage feedback signal begins to influence the control loop, which causes the output current to decrease although the output voltage has not reached 4.2V. The output voltage limit dominates the controller when the

battery reaches 4.2V and eventually the controller is entirely in CV regulation. The soft transition effectively reduces the charge current below that which is permitted for a portion of the charge cycle, which increases charge time.

In the SC810, a logical transition is implemented from CC to CV to recover the charge current lost due to the soft transition. The controller regulates only current until the output voltage exceeds the transition threshold voltage. It then switches to CV regulation. The transition voltage from CC to CV regulation is typically 5mV higher than the CV regulation voltage, which provides a sharp and clean transition free of chatter between regulation modes. The difference between the transition voltage and the regulation voltage is termed the CC/CV overshoot. While in CV regulation, the output current sense remains active. If the output current exceeds the programmed fast-charge current by 5%, the controller reverts to current regulation.

The logical transition from CC to CV results in the fastest possible charging cycle that is compliant with the specified current and voltage limits of the Li-ion cell. The output current is constant at the CC limit, then decreases abruptly when the output voltage steps from the overshoot voltage to the regulation voltage at the transition to CV control.

Thermal Limiting

Device thermal limiting is the third output constraint of the CC/CV/TL control. This feature permits a higher input OVP threshold, and thus the use of higher voltage or poorly regulated adapters. If high input voltage results in excessive power dissipation, the output current is reduced to prevent overheating of the SC810. The thermal limiting controller reduces the output current by $i_T \approx -50\text{mA}/^\circ\text{C}$ for any junction temperature $T_J > T_{TL}$.

When thermal limiting is inactive,

$$T_J = T_A + V_{\Delta} I_{FQ} \theta_{JA}$$

where V_{Δ} is the voltage difference between the VIN pin and the BAT pin. However, if T_J computed this way exceeds T_{TL} , then thermal limiting will become active and the thermal limiting regulation junction temperature will be

Applications Information (continued)

$$T_{JTL} = T_A + V_{\Delta} I(T_{JTL}) \theta_{JA}$$

where

$$I(T_{JTL}) = I_{FQ} + i_T (T_{JTL} - T_{TL})$$

(Note that i_T is a negative quantity.) Combining these two equations and solving for T_{JTL} , the steady state junction temperature during active thermal limiting is

$$T_{JTL} = \frac{T_A + V_{\Delta} (I_{FQ} - i_T T_{TL}) \theta_{JA}}{1 - V_{\Delta} i_T \theta_{JA}}$$

Although the thermal limiting controller is able to reduce output current to zero, this does not happen in practice. Output current is reduced to $I(T_{JTL})$, reducing power dissipation such that die temperature equilibrium T_{JTL} is reached.

While thermal limiting is active, all charger functions remain active and the charger logical state is preserved.

Operating a Charging Adapter in Current Limit

In high charging current applications, charger power dissipation can be greatly reduced by operating the charging adapter in current limit. The SC810 supports adapter-current-limited charging with a low UVLO falling threshold and with internal circuitry designed for low input voltage operation. To operate an adapter in current limit, R_{IPRGM} is chosen such that the programmed fast-charge current I_{FQ} exceeds the current limit of the charging adapter I_{AD-LIM} .

Note that if I_{AD-LIM} is less than 20% of I_{FQ} , then the adapter voltage can be pulled down to the battery voltage while the battery voltage is below the pre-charge threshold. In this case, care must be taken to ensure that the adapter will maintain its current limit below 20% of I_{FQ} at least until the battery voltage exceeds the pre-charge threshold. Failure to do so could permit charge current to exceed the pre-charge current while the battery voltage is below the pre-charge threshold. This happens because the low input voltage will also compress the pre-charge threshold internal reference voltage to below the battery voltage. This will prematurely advance the charger logic from pre-charge current regulation to fast-charge regulation, and the charge current will exceed the safe level recommended for pre-charge conditioning.

The low UVLO falling threshold ($V_{T_{UVLO-F}}$) permits the adapter voltage to be pulled down to just above the battery voltage by the charging load whenever the adapter current limit is less than the programmed fast-charge current. The SC810 should be operated with adapter voltage below the rising selection threshold ($V_{T_{UVLO-R}}$) only if the low input voltage is the result of adapter current limiting. This implies that the VIN pin first exceeds $V_{T_{UVLO-R}}$ to begin charging, and is subsequently pulled down to just above the battery voltage by the charging load.

Interaction of Thermal Limiting and Current Limited Adapter Charging

To permit the charge current to be limited by the adapter, it is necessary that the fast-charge current be programmed greater than the maximum adapter current, (I_{AD-LIM}). In this configuration, the CC regulator will operate with its pass device fully on (in saturation, also called “dropout”). The voltage drop from VIN to BAT is determined by the product of the minimum R_{DS-ON} of the pass device multiplied by the adapter supply current.

In dropout, the power dissipation in the SC810 is $P_{ILIM} = (\text{minimum } R_{DS-ON}) \times (I_{AD-LIM})^2$. Since minimum R_{DS-ON} does not vary with battery voltage, dropout power dissipation is constant throughout the CC portion of the charge cycle while the adapter remains in current limit. The SC810 junction temperature will rise above ambient by $P_{ILIM} \times \theta_{JA}$. If the device temperature rises to the temperature at which the TL control loop limits charging current (rather than the current being limited by the adapter), the input voltage will rise to the adapter regulation voltage. The power dissipation will increase so that the TL regulation will further limit charge current. This will keep the adapter in voltage regulation for the remainder of the charge cycle. In this case, the SC810 will continue to charge with thermal limiting until charge current decreases while in CV regulation (reducing power dissipation sufficiently). This results in a slow charge cycle, but with no other negative effect.

To ensure that the adapter remains in current limit, the internal device temperature must not rise to T_{TL} . This implies that θ_{JA} must be kept small enough, through careful layout, to ensure that $T_J = T_A + (P_{ILIM} \times \theta_{JA}) < T_{TL}$.

Applications Information (continued)

Input Over-Voltage Protection

The VIN pin is protected from over-voltage to at least 30V above GND. When the input voltage exceeds the Over-Voltage Protection (OVP) rising threshold ($V_{T_{OVP-R}}$), charging is halted. When the input voltage falls below the OVP falling threshold ($V_{T_{OVP-F}}$), charging resumes. An OVP fault turns off the STATB output. STATB is turned on again when charging restarts.

The OVP threshold has been set relatively high to permit the use of poorly regulated adapters. Such adapters may output a high voltage until loaded by the charger. A too-low OVP threshold could prevent the charger from ever turning on and loading the adapter to a lower voltage. If the adapter voltage remains high despite the charging load, the fast thermal limiting feature will immediately reduce the charging current to prevent overheating of the SC810. This behavior is illustrated in Figure 4, in which $V_{BAT} = 3.0V$, $I_{FQ} = 700mA$, and V_{VIN} is stepped from 0V to 8.1V. Initially, power dissipation in the SC810 is 3.6W.

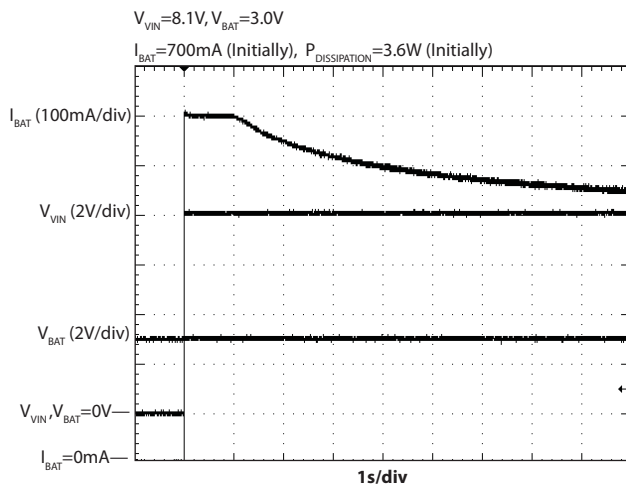

Figure 4 — Thermal Limiting Example

Notice the BAT output current is rapidly reduced to limit the internal die temperature, then continues to decline as the circuit board gradually heats up, further reducing the conduction of heat from the die to the ambient environment. The fast thermal limiting feature ensures compliance with CCSA YD/T 1591-2006, *Telecommunication Industrial Standard of the People's Republic of China — Technical Requirements and Test Method of Charger and Interface for Mobile Telecommunication Terminal*, Section 4.2.3.1.

Short Circuit Protection

The SC810 can tolerate a BAT pin short circuit to ground indefinitely. The current into a ground short (while $V_{BAT} < 1.8V$) is approximately 10mA. For $V_{BAT} > 1.8V$, normal pre-charge current regulation is active.

A short circuit or too little programming resistance to ground on the IPRGM pin ($<< 2.05k\Omega$) will prevent proper regulation of the BAT pin output current. Prior to enabling the output a check of the IPRGM pin is performed to ensure that there is sufficient resistance to ground. A test current is output on the IPRGM pin. If the test current produces a voltage of sufficient amplitude, then the output is enabled. An example with $R_{IPRGM} = 2.94k\Omega$ is illustrated in Figure 5, in which the test current is applied for approximately 250 μs to determine that there is no pin short. If a short is detected, the test current persists until the short to ground is removed, and then the charging startup sequence will continue normally.

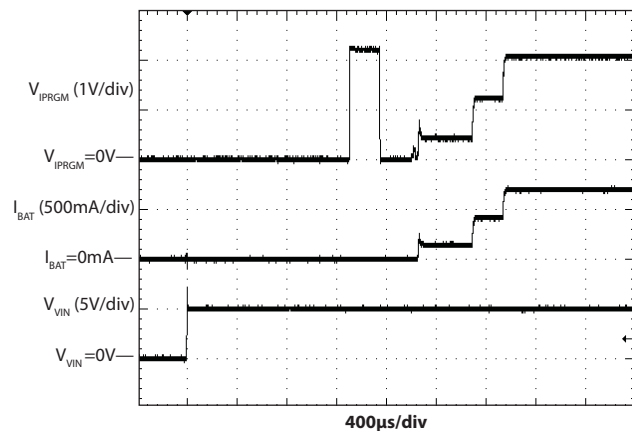

Figure 5 — IPRGM Pin Short-to-Ground Test During Startup

A short to ground applied to the IPRGM pin while charging will also be detected, by a different method. IPRGM pin short-to-ground detection on the IPRGM pin forces the SC810 into reset. When the IPRGM ground short is removed, the charger begins normal operation automatically without input power cycling.

Over-Current Protection

Over-current protection is provided in all modes of operation, including CV regulation. The output current is limited to either the programmed pre-charge current limit value

Applications Information (continued)

or the fast-charge current limit value, depending on the voltage at the output.

Operation Without a Battery

The SC810 can be operated as a 4.2V LDO regulator without the battery present, for example, for factory testing. If this use is anticipated, the total output capacitance, C_{BAT} plus any other capacitors tied directly to BAT pin network, should be at least 2.2 μ F but less than 22 μ F to ensure stability in CV regulation. To operate the charger without a battery, the ENB pin must be driven low or grounded. The output current is limited by the programmed fast-charge current. The charger should not be disabled ($V_{ENB} > V_{IH}$) without a battery present.

Dynamically Selectable Charge Current

The IPRGM resistance can be altered dynamically under processor control by switching a second IPRGM pin resistor. When the higher current is required, the switch is turned on, making the effective programming resistance equal to the parallel combination of the two resistors. The external circuit is illustrated in Figure 6.

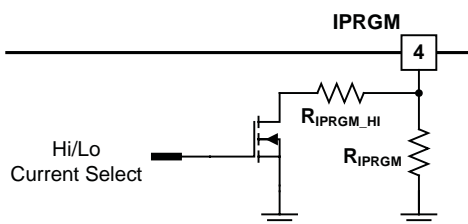

Figure 6 — Dynamic selection of low and high charge currents.

Note that the IPRGM pin resistor programs the fast-charge, pre-charge, and termination currents, so all will be modified by a change in the IPRGM pin resistor.

An open-drain GPIO can be used directly to engage the parallel resistor R_{IPRGM_HI} . Care must be taken to ensure that the R_{DS-ON} of the GPIO is considered in the selection of R_{IPRGM_HI} . Also important is the part-to-part and temperature variation of the GPIO R_{DS-ON} and their contribution to the High Current charge current tolerance. Note also that IPRGM will be pulled up briefly to as high as 3V during startup to check for an IPRGM static pinshort to ground. A small amount of current could, potentially, flow from IPRGM into the GPIO ESD structure through R_{IPRGM_HI} during

this event. While unlikely to do any harm, this effect must also be considered.

USB Dedicated Charger Compatibility

The SC810 is well suited to the USB Charging Specification, Revision 1.0, Dedicated Charger, Sections 3.5 and 4.1, due to thermal limiting and its current-limited-supply charging behavior.

The USB Dedicated Charger is required to limit its output current to more than 0.5A and less than 1.5A. A dedicated charger identifies itself by shorting together the USB D+ and D- lines. Once the dedicated charger is detected, the SC810, with its 1A maximum programmed fast charge current, permits the fast-charge current to be set higher than the 500mA USB High Power Mode specified limit to permit faster charging of a large battery. (See the section Dynamically Selectable Charge Current.)

If the USB Dedicated Charger's current limit exceeds the SC810 programmed fast-charge current, then its output will regulate to 5V, and the fast-charge current will be determined by the SC810 IPRGM pin resistance to ground. If the resulting power dissipation in the SC810 causes an excessive rise in temperature, then thermal limiting will reduce the charge current as needed to ensure safe charging. But if the USB Dedicated charger's current limit is less than the SC810 programmed fast-charge current, then its output voltage will be pulled down to the battery voltage plus charging path dropout. (The USB Dedicated Charger is required to maintain its current limit down to 2V.) This behavior is recognized in the USB Battery Charging Specification, Section 3.5, as an accepted means to reduce power dissipation in the charging circuit while charging at high current.

The SC810 thermal limiting and current-limited-adaptor charging capability together ensure reliable charging at any programmed charge current, using any USB Battery Charging Specification compliant Dedicated Charger, regardless of its current limit.

External Power Path Management

Some applications require that the battery be isolated from the load while charging. Figure 7 illustrates a typical charger bypass circuit. This circuit powers the load directly from the charging source via the Schottky diode D_{BYPASS} .

Applications Information (continued)

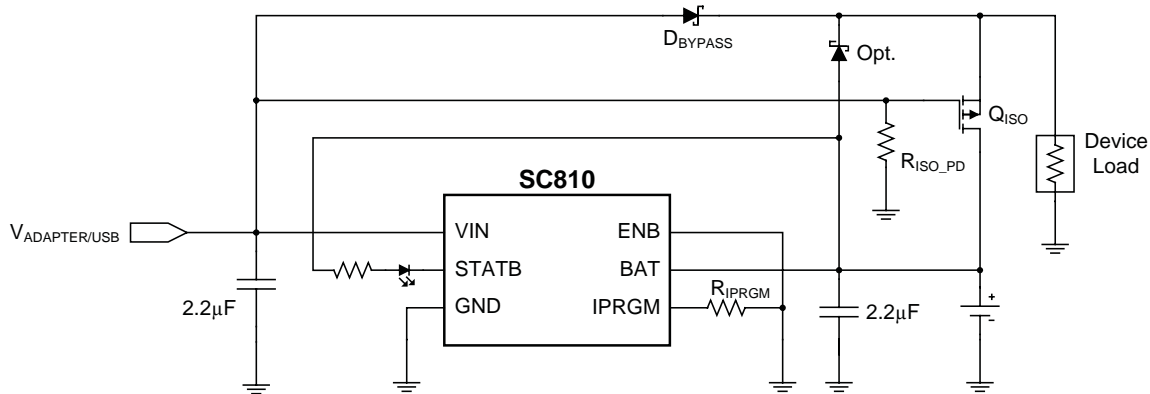

Figure 7 — Battery Isolation and Power Path Bypass, Powering the Load Directly From the Charging Adapter

When the charging source is present, the p-channel MOSFET battery isolation switch Q_{ISO} source-to-gate voltage V_{SG} is equal to minus the D_{BYPASS} forward-biased voltage drop, ensuring that the switch Q_{ISO} is off (open). When the charging source is removed, the MOSFET gate is pulled down to ground by R_{ISO_PD} , closing the battery isolation switch and connecting the battery to the load.

When the charging source is removed, the turn-on of Q_{ISO} could be delayed due to its gate capacitance. If so, the substrate PN diode of Q_{ISO} will become forward biased, holding the load voltage to within 0.7V of the battery voltage until $V_{SG} > V_{TH}$, turning on Q_{ISO} . This momentary voltage drop can be mitigated by the use of an optional Schottky diode in parallel with Q_{ISO} , as shown.

With the load isolated from the battery, the charging adapter must supply both the load current and the charging current. If the sum of these should ever exceed the current capacity of the adapter, $V_{ADAPTER}$ will be pulled down. Current limited adapter operation of the SC810 ensures charge cycle integrity if the device load pulls the adapter voltage down to the battery voltage plus charger dropout voltage at the CC current, or even deeper into dropout if necessary to further reduce the charge current to power the device load.

To better understand the trade-offs between charger bypass and direct connection of the load to the battery, see the Semtech Application Note AN-PM-0802, *Tradeoffs Between Direct Battery Connection vs. Bypassing the Charger*.

Capacitor Selection

Low cost, low ESR ceramic capacitors such as the X5R and X7R dielectric material types are recommended. The BAT pin capacitor should be at least $1\mu\text{F}$, but can be as large as desired to accommodate the required input capacitors of regulators connected directly to the battery terminal. BAT pin total capacitance must be limited if the SC810 is to be operated without the battery present. See the section Operation Without a Battery. The VIN pin capacitor is typically between $0.1\mu\text{F}$ and $2.2\mu\text{F}$, although larger values will not degrade performance. Capacitance must be evaluated at the expected bias voltage (4.2V for the BAT pin capacitor, the expected V_{VIN} supply regulation voltage for the VIN pin capacitor), rather than the zero-volt capacitance rating.

PCB Layout Considerations

Layout for linear devices is not as critical as for a switching regulator. However, careful attention to detail will ensure reliable operation.

- Place input and output capacitors close to the device for optimal transient response and device behavior.
- Connect all ground connections directly to the ground plane. If there is no ground plane, connect to a common local ground point before connecting to board ground near the GND pin.
- Attaching the part to a larger copper footprint will enable better heat transfer from the device, especially on PCBs with internal ground and power planes.

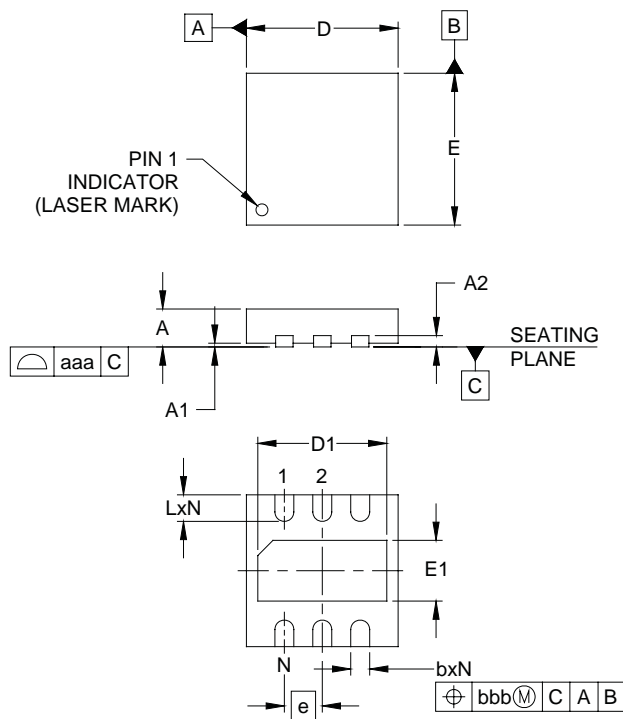
Outline Drawing — MLPD-UT6 2x2

DIM	INCHES			MILLIMETERS		
	MIN	NOM	MAX	MIN	NOM	MAX
A	.020	-	.024	0.50	-	0.60
A1	.000	-	.002	0.00	-	0.05
A2	(0.006)			(0.152)		
b	.007	.010	.012	0.18	0.25	0.30
D	.075	.079	.083	1.90	2.00	2.10
D1	.061	.067	.071	1.55	1.70	1.80
E	.075	.079	.083	1.90	2.00	2.10
E1	.026	.031	.035	0.65	0.80	0.90
e	.020 BSC			0.50 BSC		
L	.010	.014	.018	0.25	0.35	0.45
N	6			6		
aaa	.003			0.08		
bbb	.004			0.10		

NOTES:

1. CONTROLLING DIMENSIONS ARE IN MILLIMETERS (ANGLES IN DEGREES).
2. COPLANARITY APPLIES TO THE EXPOSED PAD AS WELL AS TERMINALS.

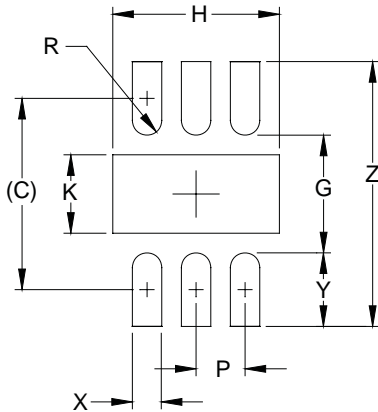
Land Pattern — MLPD-UT6 2x2

DIMENSIONS		
DIM	INCHES	MILLIMETERS
C	(.077)	(1.95)
G	.047	1.20
H	.067	1.70
K	.031	0.80
P	.020	0.50
R	.006	0.15
X	.012	0.30
Y	.030	0.75
Z	.106	2.70

NOTES:

1. CONTROLLING DIMENSIONS ARE IN MILLIMETERS (ANGLES IN DEGREES).
2. THIS LAND PATTERN IS FOR REFERENCE PURPOSES ONLY. CONSULT YOUR MANUFACTURING GROUP TO ENSURE YOUR COMPANY'S MANUFACTURING GUIDELINES ARE MET.
3. THERMAL VIAS IN THE LAND PATTERN OF THE EXPOSED PAD SHALL BE CONNECTED TO A SYSTEM GROUND PLANE. FAILURE TO DO SO MAY COMPROMISE THE THERMAL AND/OR FUNCTIONAL PERFORMANCE OF THE DEVICE.

Contact Information

Semtech Corporation
 Power Management Products Division
 200 Flynn Road, Camarillo, CA 93012
 Phone: (805) 498-2111 Fax: (805) 498-3804

www.semtech.com



**Стандарт
Электрон
Связь**

Мы молодая и активно развивающаяся компания в области поставок электронных компонентов. Мы поставляем электронные компоненты отечественного и импортного производства напрямую от производителей и с крупнейших складов мира.

Благодаря сотрудничеству с мировыми поставщиками мы осуществляем комплексные и плановые поставки широчайшего спектра электронных компонентов.

Собственная эффективная логистика и склад в обеспечивает надежную поставку продукции в точно указанные сроки по всей России.

Мы осуществляем техническую поддержку нашим клиентам и предпродажную проверку качества продукции. На все поставляемые продукты мы предоставляем гарантию .

Осуществляем поставки продукции под контролем ВП МО РФ на предприятия военно-промышленного комплекса России , а также работаем в рамках 275 ФЗ с открытием отдельных счетов в уполномоченном банке. Система менеджмента качества компании соответствует требованиям ГОСТ ISO 9001.

Минимальные сроки поставки, гибкие цены, неограниченный ассортимент и индивидуальный подход к клиентам являются основой для выстраивания долгосрочного и эффективного сотрудничества с предприятиями радиоэлектронной промышленности, предприятиями ВПК и научно-исследовательскими институтами России.

С нами вы становитесь еще успешнее!

Наши контакты:

Телефон: +7 812 627 14 35

Электронная почта: sales@st-electron.ru

Адрес: 198099, Санкт-Петербург,
Промышленная ул, дом № 19, литера Н,
помещение 100-Н Офис 331