



## MMIC VCO w/ HALF FREQUENCY OUTPUT 6.65 - 7.65 GHz

### Typical Applications

Low noise MMIC VCO w/Half Frequency, for:

- VSAT Radio
- Point to Point/Multi-Point Radio
- Test Equipment & Industrial Controls
- Military End-Use

### Features

- Dual Output:  $F_o = 6.65 - 7.65$  GHz  
 $F_o/2 = 3.325 - 3.825$  GHz
- Pout: +13.5 dBm
- Phase Noise: -115 dBc/Hz @100 kHz Typ.
- No External Resonator Needed
- 32 Lead 5x5mm SMT Package: 25mm<sup>2</sup>

### Functional Diagram

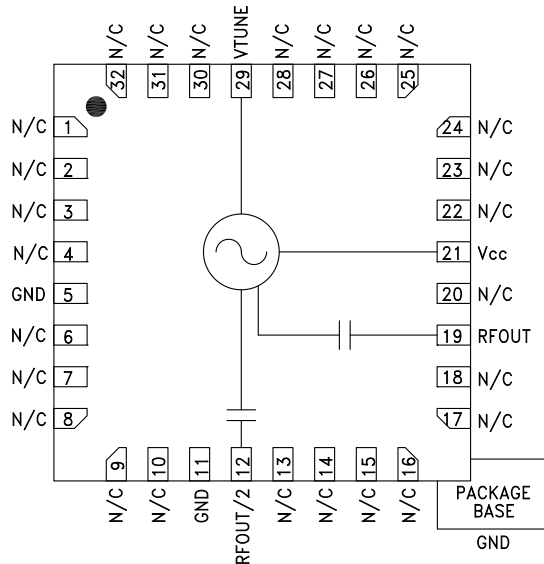

### General Description

The HMC507LP5 & HMC507LP5E are GaAs InGaP Heterojunction Bipolar Transistor (HBT) MMIC VCOs. The HMC507LP5 & HMC507LP5E integrate resonators, negative resistance devices, varactor diodes and feature a half frequency output. The VCO's phase noise performance is excellent over temperature, shock, and process due to the oscillator's monolithic structure. Power output is +13.5 dBm typical from a +5V supply. The voltage controlled oscillator is packaged in a leadless QFN 5x5 mm surface mount package, and requires no external matching components.

### Electrical Specifications, $T_A = +25^\circ C$ , $V_{cc} = +5V$

Parameter	Min.	Typ.	Max.	Units	
Frequency Range	$F_o$	6.65 - 7.65		GHz	
	$F_o/2$	3.325 - 3.825		GHz	
Power Output	RFOUT	+11	+16	dBm	
	RFOUT/2	+4	+10	dBm	
SSB Phase Noise @ 100 kHz Offset, $V_{tune} = +5V$ @ RFOUT		-115		dBc/Hz	
Tune Voltage	$V_{tune}$	2	13	V	
Supply Current ( $I_{cc}$ ) ( $V_{cc} = +5.0V$ )		200	230	270	mA
Tune Port Leakage Current ( $V_{tune} = 13V$ )			10	$\mu A$	
Output Return Loss		2		dB	
Harmonics/Subharmonics	1/2	35		dBc	
	2nd	4		dBc	
	3rd	24		dBc	
Pulling (into a 2.0:1 VSWR)		8		MHz pp	
Pushing @ $V_{tune} = 5V$		15		MHz/V	
Frequency Drift Rate		0.9		MHz/ $^\circ C$	

Information furnished by Analog Devices is believed to be accurate and reliable. However, no responsibility is assumed by Analog Devices for its use, nor for any infringements of patents or other rights of third parties that may result from its use. Specifications subject to change without notice. No license is granted by implication or otherwise under any patent or patent rights of Analog Devices. Trademarks and registered trademarks are the property of their respective owners.

For price, delivery, and to place orders: Analog Devices, Inc., One Technology Way, P.O. Box 9106, Norwood, MA 02062-9106  
Phone: 781-329-4700 • Order online at [www.analog.com](http://www.analog.com)  
Application Support: Phone: 1-800-ANALOG-D



# HMC507LP5 / 507LP5E

## MMIC VCO w/ HALF FREQUENCY OUTPUT 6.65 - 7.65 GHz

**Frequency vs. Tuning Voltage,  $T = 25^{\circ}\text{C}$**

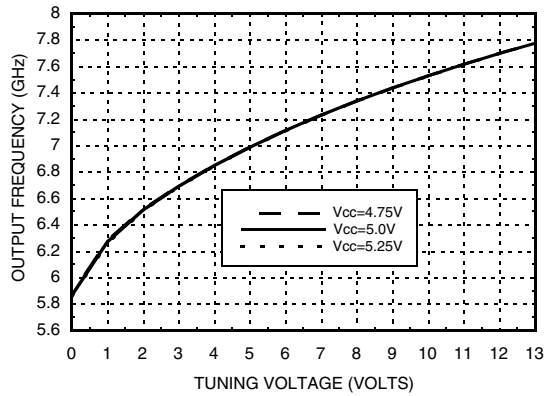

**Frequency vs. Tuning Voltage,  $V_{cc} = +5V$**

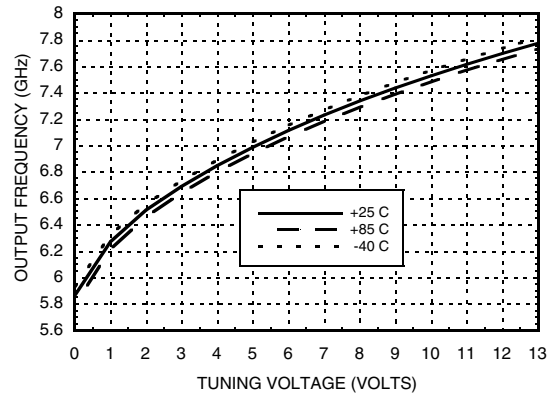

**Sensitivity vs. Tuning Voltage,  $V_{cc} = +5V$**

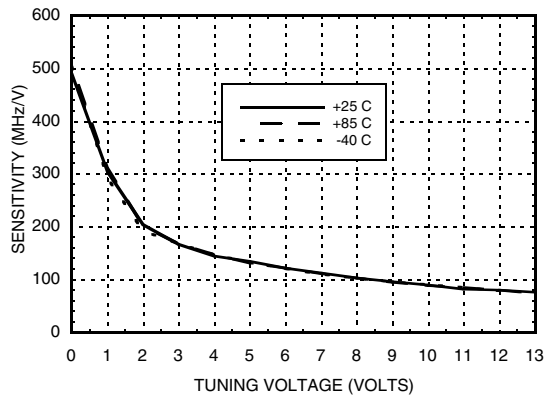

**Output Power vs. Tuning Voltage,  $V_{cc} = +5V$**

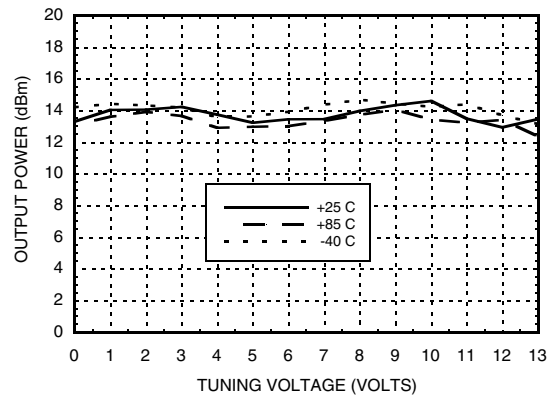

**SSB Phase Noise vs. Tuning Voltage**

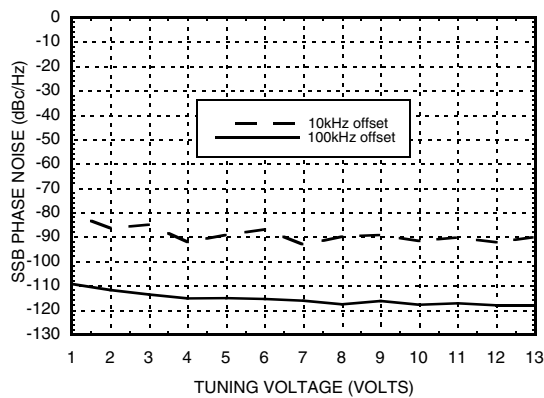

**SSB Phase Noise @  $V_{tune} = +5V$**

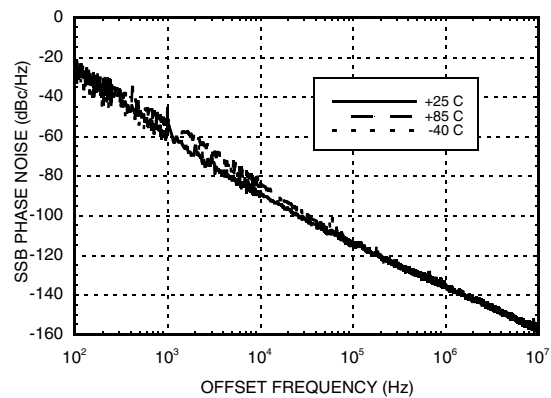

Information furnished by Analog Devices is believed to be accurate and reliable. However, no responsibility is assumed by Analog Devices for its use, nor for any infringements of patents or other rights of third parties that may result from its use. Specifications subject to change without notice. No license is granted by implication or otherwise under any patent or patent rights of Analog Devices. Trademarks and registered trademarks are the property of their respective owners.

For price, delivery, and to place orders: Analog Devices, Inc., One Technology Way, P.O. Box 9106, Norwood, MA 02062-9106 Phone: 781-329-4700 • Order online at [www.analog.com](http://www.analog.com) Application Support: Phone: 1-800-ANALOG-D



## MMIC VCO w/ HALF FREQUENCY OUTPUT 6.65 - 7.65 GHz

**RFOUT/2 Frequency vs. Tuning Voltage, Vcc= +5V**

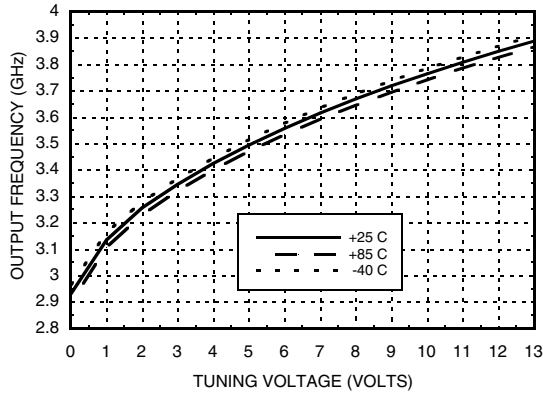

**RFOUT/2 Output Power vs. Tuning Voltage, Vcc= +5V**

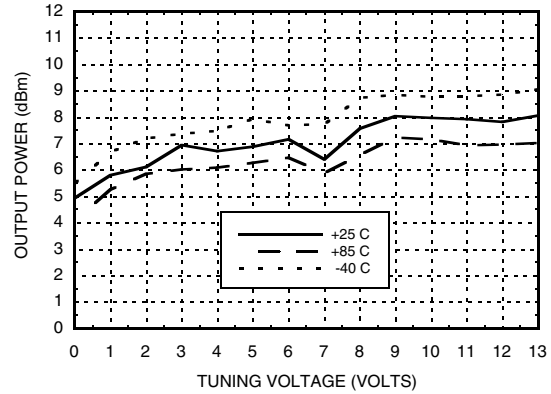

### Absolute Maximum Ratings

Vcc	+5.5 Vdc
Vtune	0 to +15V
Junction Temperature	135 °C
Continuous Pdiss (T=85 °C) (derate 26.7 mW/C above 85 °C)	1.35 W
Thermal Resistance (junction to ground paddle)	37 °C/W
Storage Temperature	-65 to +150 °C
Operating Temperature	-40 to +85 °C
ESD Sensitivity (HBM)	Class 1A

### Typical Supply Current vs. Vcc

Vcc (V)	Icc (mA)
4.75	210
5.0	225
5.25	242

Note: VCO will operate over full voltage range shown above.



**ELECTROSTATIC SENSITIVE DEVICE  
OBSERVE HANDLING PRECAUTIONS**



## MMIC VCO w/ HALF FREQUENCY OUTPUT 6.65 - 7.65 GHz

### Outline Drawing

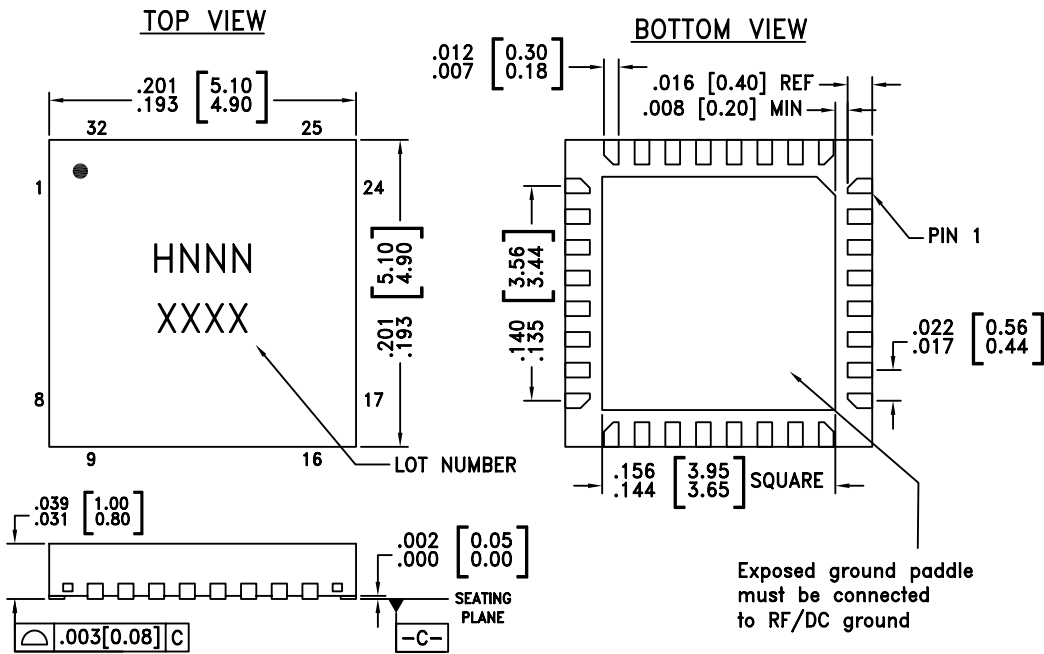

- NOTES:
1. LEADFRAME MATERIAL: COPPER ALLOY
  2. DIMENSIONS ARE IN INCHES [MILLIMETERS]
  3. LEAD SPACING TOLERANCE IS NON-CUMULATIVE.
  4. PAD BURR LENGTH SHALL BE 0.15mm MAXIMUM.  
PAD BURR HEIGHT SHALL BE 0.05mm MAXIMUM.
  5. PACKAGE WARP SHALL NOT EXCEED 0.05mm.
  6. ALL GROUND LEADS AND GROUND PADDLE MUST BE SOLDERED TO PCB RF GROUND.
  7. REFER TO HITTITE APPLICATION NOTE FOR SUGGESTED LAND PATTERN.

### Package Information

Part Number	Package Body Material	Lead Finish	MSL Rating	Package Marking <sup>[3]</sup>
HMC507LP5	Low Stress Injection Molded Plastic	Sn/Pb Solder	MSL3 <sup>[1]</sup>	H507 XXXX
HMC507LP5E	RoHS-compliant Low Stress Injection Molded Plastic	100% matte Sn	MSL3 <sup>[2]</sup>	H507 XXXX

- [1] Max peak reflow temperature of 235 °C  
 [2] Max peak reflow temperature of 260 °C  
 [3] 4-Digit lot number XXXX



## MMIC VCO w/ HALF FREQUENCY OUTPUT 6.65 - 7.65 GHz

### Pin Descriptions

Pin Number	Function	Description	Interface Schematic
1 - 4, 6 - 10, 13 - 18, 20, 22 - 28, 30 - 32	N/C	No Connection. These pins may be connected to RF/DC ground. Performance will not be affected.	
12	RFOUT/2	Half frequency output (AC coupled).	
19	RFOUT	RF output (AC coupled).	
21	Vcc	Supply Voltage, +5V	
29	VTUNE	Control Voltage Input. Modulation port bandwidth dependent on drive source impedance.	
5, 11, Paddle	GND	Package bottom has an exposed metal paddle that must be connected to RF/DC ground.	



**MMIC VCO w/ HALF FREQUENCY  
OUTPUT 6.65 - 7.65 GHz**

**Evaluation PCB**

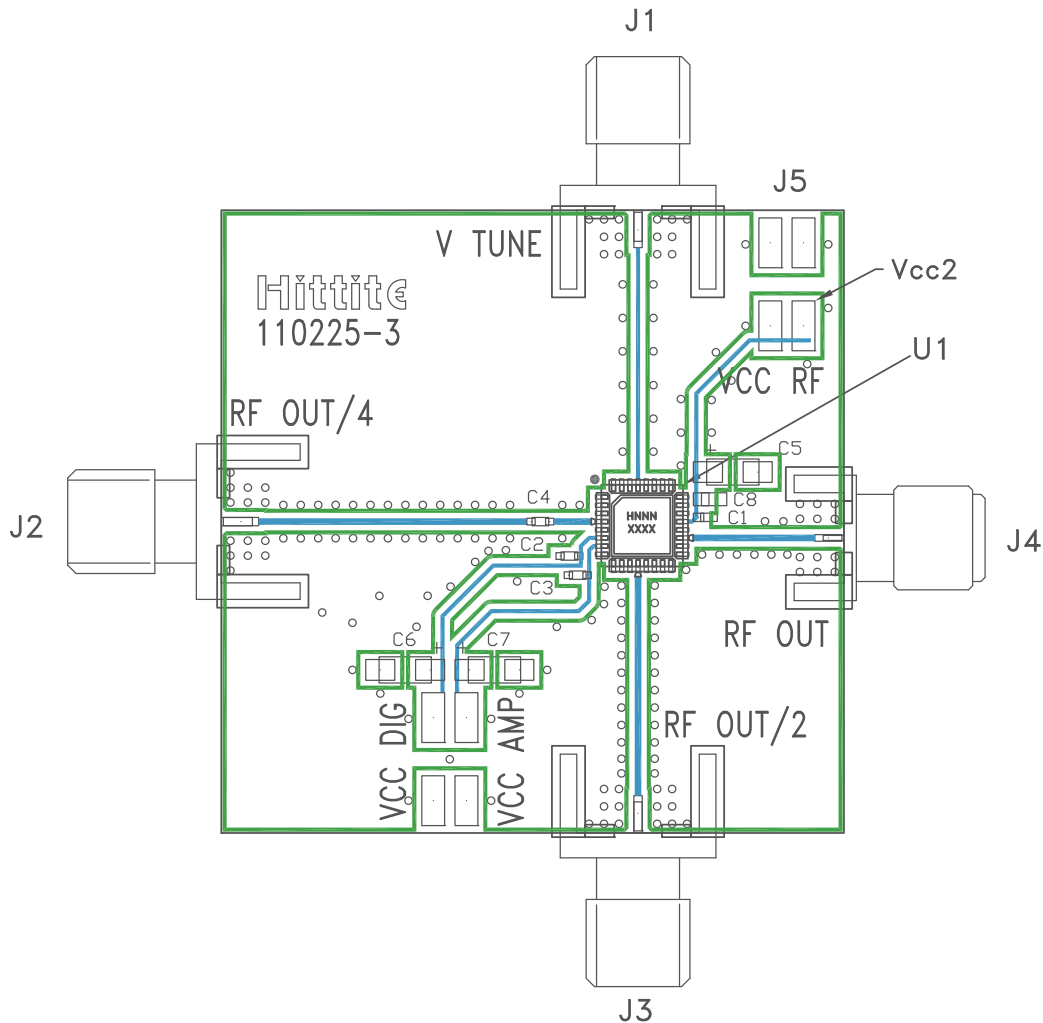

**List of Materials for Evaluation PCB 110227 [1]**

Item	Description
J1 - J4	PCB Mount SMA RF Connector
J5	2 mm DC Header
C1 - C3	100 pF Capacitor, 0402 Pkg.
C4	1,000 pF Capacitor, 0402 Pkg.
C5 - C7	2.2 $\mu$ F Tantalum Capacitor
U1	HMC507LP5(E) VCO
PCB [2]	110225 Eval Board

[1] Reference this number when ordering complete evaluation PCB

[2] Circuit Board Material: Arlon 25FR

The circuit board used in the application should use RF circuit design techniques. Signal lines should have 50 Ohm impedance while the package ground leads and backside ground paddle should be connected directly to the ground plane similar to that shown. A sufficient number of via holes should be used to connect the top and bottom ground planes. The evaluation circuit board shown is available from Hittite upon request.



## Стандарт Электрон Связь

Мы молодая и активно развивающаяся компания в области поставок электронных компонентов. Мы поставляем электронные компоненты отечественного и импортного производства напрямую от производителей и с крупнейших складов мира.

Благодаря сотрудничеству с мировыми поставщиками мы осуществляем комплексные и плановые поставки широчайшего спектра электронных компонентов.

Собственная эффективная логистика и склад в обеспечивает надежную поставку продукции в точно указанные сроки по всей России.

Мы осуществляем техническую поддержку нашим клиентам и предпродажную проверку качества продукции. На все поставляемые продукты мы предоставляем гарантию .

Осуществляем поставки продукции под контролем ВП МО РФ на предприятия военно-промышленного комплекса России , а также работаем в рамках 275 ФЗ с открытием отдельных счетов в уполномоченном банке. Система менеджмента качества компании соответствует требованиям ГОСТ ISO 9001.

Минимальные сроки поставки, гибкие цены, неограниченный ассортимент и индивидуальный подход к клиентам являются основой для выстраивания долгосрочного и эффективного сотрудничества с предприятиями радиоэлектронной промышленности, предприятиями ВПК и научно-исследовательскими институтами России.

С нами вы становитесь еще успешнее!

### Наши контакты:

**Телефон:** +7 812 627 14 35

**Электронная почта:** [sales@st-electron.ru](mailto:sales@st-electron.ru)

**Адрес:** 198099, Санкт-Петербург,  
Промышленная ул, дом № 19, литера Н,  
помещение 100-Н Офис 331