

EAO – Your Expert Partner for
Human Machine Interfaces



EAO Product Information

Audio Video

www.eao.com/av_en

e a o ■

Bringing pictures, sounds and stages to live

For more than 60 years, EAO has been one of the leading suppliers of switches and indicators for audio/video, lighting and production equipment. No wonder many of the world's best manufacturers use our products in their systems. Our customers not only appreciate the longevity and high quality but also the fair price policy. This has made us the No. 1 A/V switch supplier worldwide.

EAO is relied on to help millions of listeners, viewers and audiences enjoy broadcasts of the F1 World Championship, Grand Slam finals and Olympic Games as well as some of the greatest performances in the world's most prestigious locations – Sydney Opera House, Madison Square Garden and Wembley Stadium to name just a few.

Major film and production studios use EAO products to help capture that perfect moment, so do the many outside broadcasting vehicles as they bring you the news.

Smaller theatres and venues also benefit from EAO switches in their semi-professional audio/video mixers and public address systems, lighting rigs and control panels. Wherever there is entertainment, there is EAO.

Upgrade your Human Machine Interfaces with the unique design of EAO audio/video equipment!

Switches and Indicators

Series 95 **5**

Series 97 **17**

Series 99 **31**

Series 92 **53**

Series 96 **73**

Series 18 **91**

Series 19 **105**

Series 84 **119**

Index according to Typ-No **159**

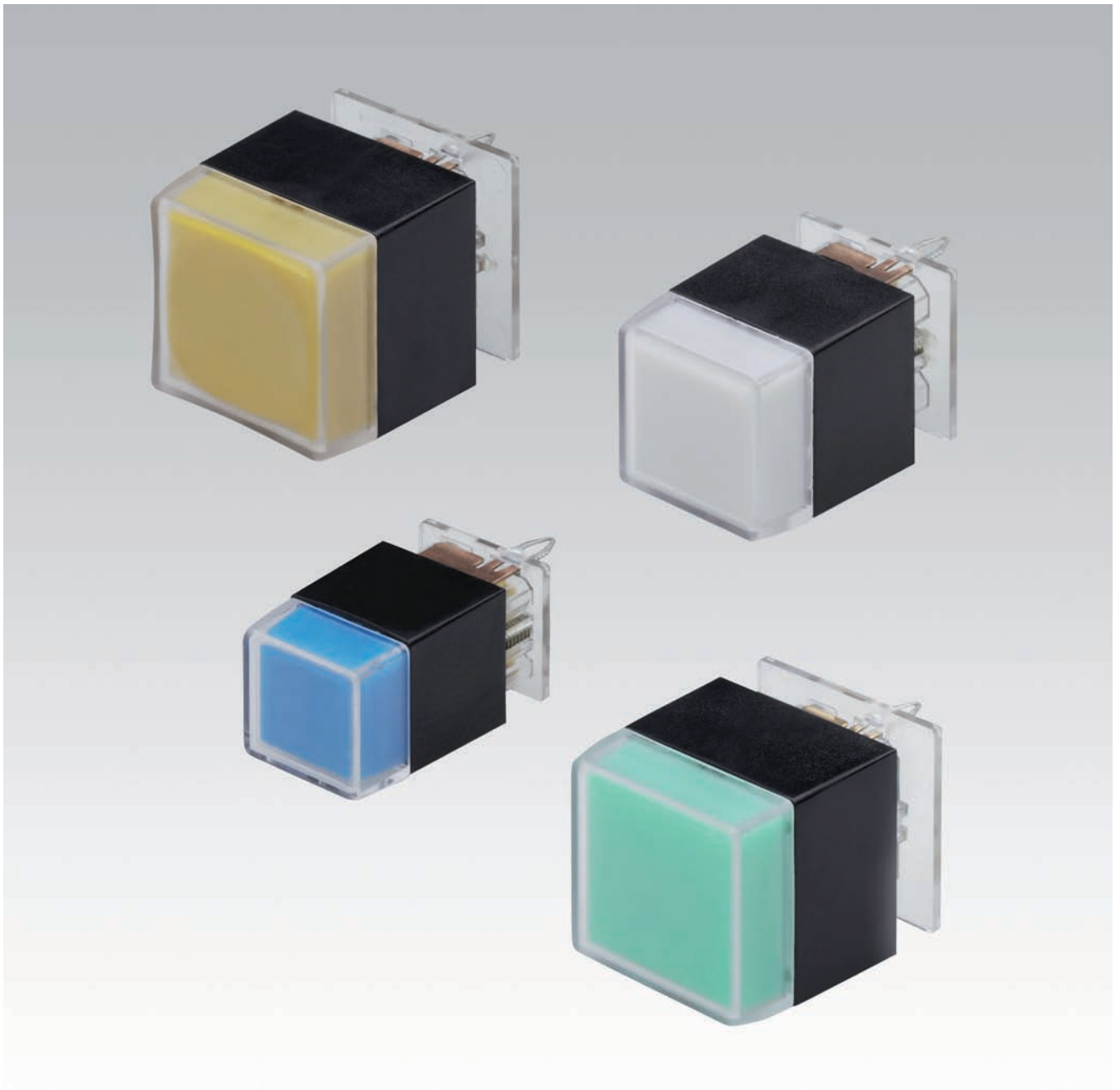

| | |
|------------------------|-----|
| Description | 7 |
| Product Assembly | 8 |
| PCB Pushbuttons | 9 |
| Accessories | 10 |
| Technical Data..... | 12 |
| Drawings..... | 13 |
| Index..... | 159 |

Product Information

General notes

The Series 95 is a high quality switch range containing illuminated and non-illuminated pushbuttons for professional Audio and Video applications. According to the switch version, the pushbuttons may be equipped with 2 or 3 SMD LED's with PLCC housing (height 2.1 mm) with a radiation angle of approx. 120 ° and thus generate up to 3 different colors on one pushbutton. The lenses are available matt translucent or clear transparent in flat, concave or convex form.

Fitting

The pushbutton should be plugged-in to the mounting hole and soldered onto the printed circuit board (PCB), after the soldering of the SMD LED's.

Mounting

Suitable for mounting on PCB's with thickness of 1.5 to 2.5 mm. The separated spring clip contact holds the switch in place during the assembly and soldering process. The soldered joint makes the electrical contact and fixes the switch in the PCB. Maximum soldering-temperature is 260 °C for 5 seconds. There is a solder stop between the SMD-LED's and the contact mounting areas. The PCB layout and mounting details are shown in the dimensional drawings. The switch must be used in a front panel.

Marking

The diffuser can either be printed or engraved, or a film insert can be fitted between the diffuser and the lens.

Illumination

Luminosity and wave length scattering caused by the technology used in the LED manufacturing processes may lead to visual differences in our products.

*We reserve the right to modify technical data
All dimensions in mm*

Pushbutton illuminative

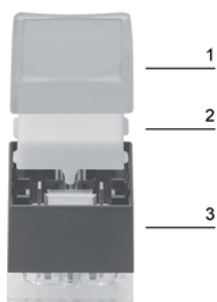

- 1 Lens
- 2 Diffuser
- 3 Switching element

Illuminated pushbutton



| | Front protection | Contacts | Switching action | Terminals | Lens | Ø 19.05 x 19.05 mm Typ-Nr. | Ø 15.88 x 15.88 mm Typ-Nr. | Ø 12.7 x 12.7 mm Typ-Nr. | Component layout | Technical drawing | |
|--|------------------|----------|------------------|-----------|--|-------------------------------|-------------------------------|-----------------------------|------------------|-------------------|-------|
| Illuminated pushbutton high gloss finished | IP 40 | 1 NO | M | P | Plastic colourless transparent concave | 95-414.770 | | | 3 | 3 | 0.004 |
| | | | | | Plastic colourless transparent flush | 95-414.750 | | | 3 | 3 | 0.004 |
| mat | IP 40 | 1 NO | M | P | Plastic colourless transparent concave | 95-414.740 | | | 3 | 3 | 0.004 |
| | | | | | Plastic colourless transparent convex | 95-414.730 | | | 3 | 3 | 0.004 |
| high gloss finished | IP 40 | 1 NO | M | P | Plastic colourless transparent concave | | 95-515.770 | | 2 | 2 | 0.004 |
| | | | | | Plastic colourless transparent flush | | 95-515.750 | | 2 | 2 | 0.004 |
| mat | IP 40 | 1 NO | M | P | Plastic colourless transparent concave | | 95-515.740 | | 2 | 2 | 0.004 |
| | | | | | Plastic colourless transparent flush | | 95-515.720 | | 2 | 2 | 0.004 |
| high gloss finished | IP 40 | 1 NO | M | P | Plastic colourless transparent flush | | | 95-313.750 | 1 | 1 | 0.003 |
| mat | IP 40 | 1 NO | M | P | Plastic colourless transparent flush | | | 95-313.720 | 1 | 1 | 0.003 |

Contacts: NO = Normally open

Switching action: M = Momentary action

Terminals: P = PCB terminal

Component layout from page 13, Technical drawing from page 14

Front

Lens

| | Lens | ∅ 19.05 x 19.05 mm Typ-Nr. | ∅ 15.88 x 15.88 mm Typ-Nr. | ∅ 12.7 x 12.7 mm Typ-Nr. |  |
|------------------------------------|--|-------------------------------|-------------------------------|-----------------------------|---|
| Lens high gloss finished | Plastic colourless transparent concave | 95-704.770 | 95-705.770 | | 0.001 |
| | Plastic colourless transparent convex | 95-704.760 | | | 0.001 |
| | Plastic colourless transparent flush | 95-704.750 | | 95-703.750 | 0.001 |
| mat | Plastic colourless transparent concave | 95-704.740 | 95-705.740 | | 0.001 |
| | Plastic colourless transparent convex | 95-704.730 | 95-705.730 | | 0.001 |
| | Plastic colourless transparent flush | 95-704.720 | 95-705.720 | 95-703.720 | 0.001 |



Diffuser

| | Diffuser | ∅ 19.05 x 19.05 mm Typ-Nr. | ∅ 15.88 x 15.88 mm Typ-Nr. | ∅ 12.7 x 12.7 mm Typ-Nr. |  |
|-----------------|--------------------------------|-------------------------------|-------------------------------|-----------------------------|---|
| Diffuser | Plastic blue translucent | 95-804.620 | | 95-803.620 | 0.001 |
| | Plastic colourless transparent | 95-804.720 | | 95-803.720 | 0.001 |
| | Plastic green translucent | 95-804.520 | | 95-803.520 | 0.001 |
| | Plastic orange translucent | 95-804.320 | | 95-803.320 | 0.001 |
| | Plastic red translucent | 95-804.220 | | 95-803.220 | 0.001 |
| | Plastic white translucent | 95-804.920 | 95-805.920 | 95-803.920 | 0.001 |
| | Plastic yellow translucent | 95-804.420 | | 95-803.420 | 0.001 |



Backside

Switching element

| | Switching action | Contacts | ∅ 19.05 x 19.05 mm Typ-Nr. | ∅ 15.88 x 15.88 mm Typ-Nr. | ∅ 12.7 x 12.7 mm Typ-Nr. | Component layout |  |
|---|------------------|----------|-------------------------------|-------------------------------|-----------------------------|------------------|---|
| Switching element without Lens and Diffuser | M | 1 NO | 95-414.000 | | | 3 | 0.003 |
| | | | | 95-515.000 | | 2 | 0.002 |
| | | | | | 95-313.000 | 1 | 0.002 |



for combining with Lens and Diffuser
 Switching action: M = Momentary action
 Contacts: NO = Normally open
 Component layout from page 13

Assembling

Lens remover

| | Typ-Nr. |  kg |
|--------------|------------|--|
| Lens remover | 95-900.005 | 0.003 |

Owing to possible mechanical damage removed lens must be replaced by a new part



Mounting tool

| | Typ-Nr. |  kg |
|---------------|------------|--|
| Mounting tool | 95-900.009 | 0.003 |



Pushbutton- and illuminated pushbutton

Shock resistance

50 g, 11 ms, as per IEC 60512-4-3

Switching system

Gold plated momentary contact, 1 normally open, self-cleaning

Material

Plastic parts

PC, as per UL 94 HB, Cd-free

Material of contacts

CuSn, contact gold-plated, soldering terminal tinned

Mechanical characteristics

Actuating travel

4.5 mm

Actuating force

3 N to end position

Switching point

2.3 mm \pm 0.8 mm at operation

Life time

>5 million operations, as per IEC 60512-5-9a

Electrical characteristics

Illumination

recommended SMD-LED types:
P-LCC package or similar, radiation angle approx. 120 °;
use of smaller SMD-LED is possible.

SMD-LED configurations size:

max. 2 SMD-LEDs for switch size 12.70 mm
max. 3 SMD-LEDs for switch size 15.88 mm and 19.05 mm, single
colour or multi-colour.

Height of SMD-LED:

max. 2.1 mm

Electric strength

\leq 50 m Ω , as per IEC 60512-2-2b at new state

Isolation resistance

>1 T Ω , as per IEC 60512-2-3a between contacts

Switch rating

min. 1 mVDC, 100 μ A
max. 48 VDC, 50 mA

Electric strength

2.5 kVAC, as per IEC 60512-2-11

Environmental conditions

Front protection

IP 40 before front plate for complete switch

Operating temperature

-25 °C ... +70 °C

Storage temperature

-40 °C ... +80 °C

Vibration resistance

10 g, at 10 - 2000 Hz, 0.75 mm, as per IEC 60512-4-4

Component layout

1 Illuminated pushbutton page 9 | Switching element page 10

Layout (Elementside)

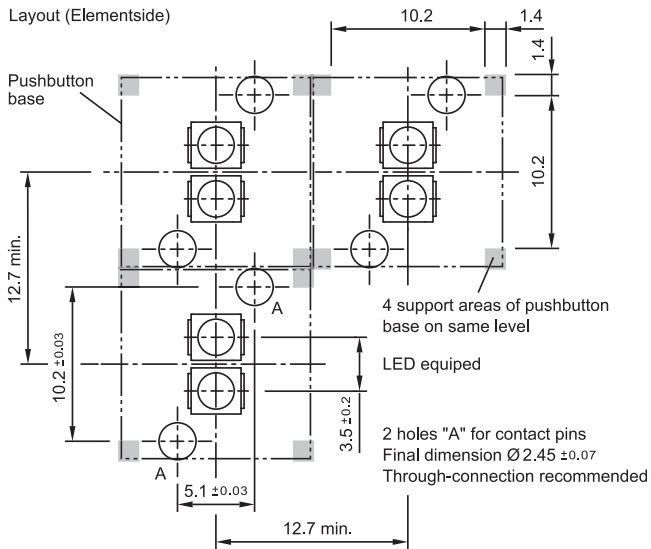

Libraries for the PCB layout-system p-cad 200X see : www.pcad.com/recources/libraries Third-party Libraries

2 Illuminated pushbutton page 9 | Switching element page 10

Layout (Elementside)

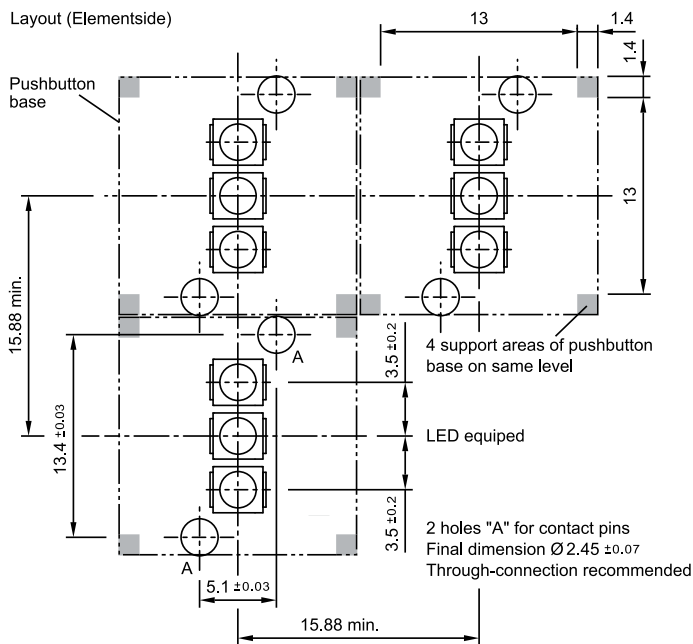

Libraries for the PCB layout-system p-cad 200X see : www.pcad.com/recources/libraries Third-party Libraries

3 Illuminated pushbutton page 9 | Switching element page 10

Layout (Elementside)

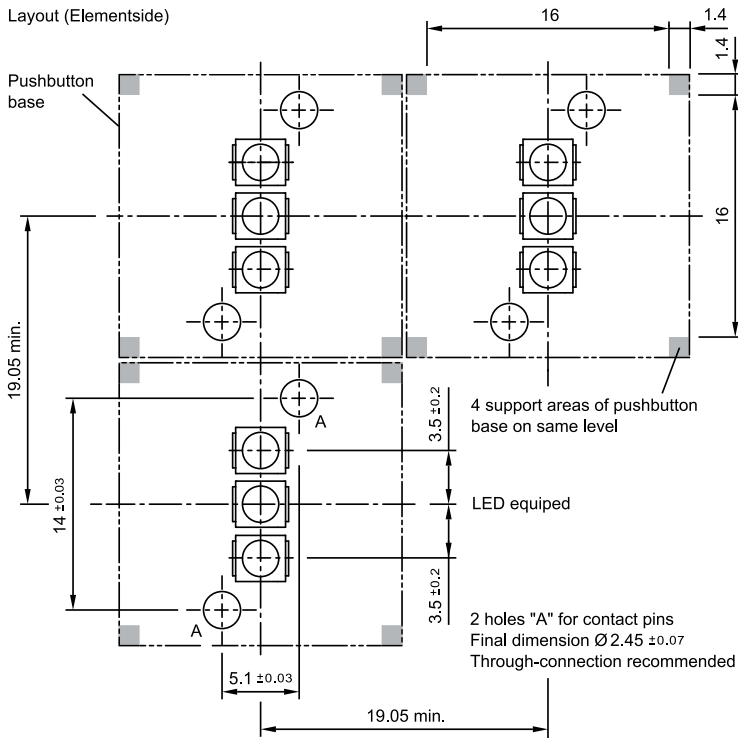

Libraries for the PCB layout-system p-cad 200X see : www.pcad.com/recources/libraries Third-party Libraries

Technical drawing

1 Illuminated pushbutton page 9

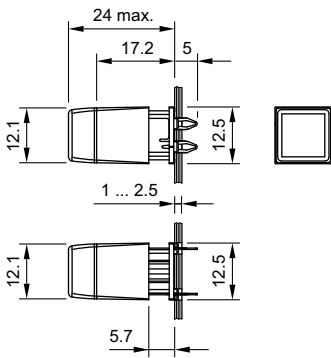

2 Illuminated pushbutton page 9

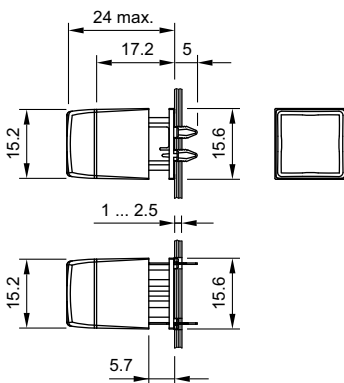

3 Illuminated pushbutton page 9

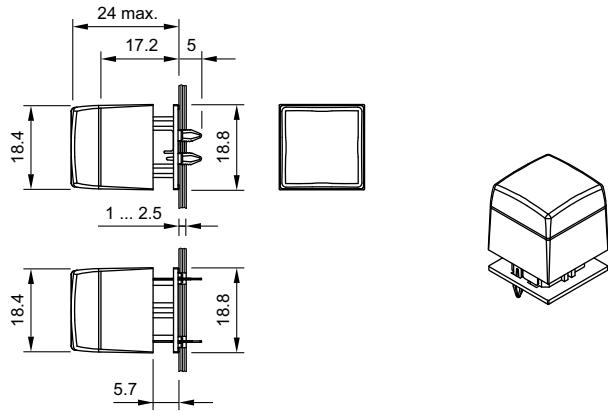

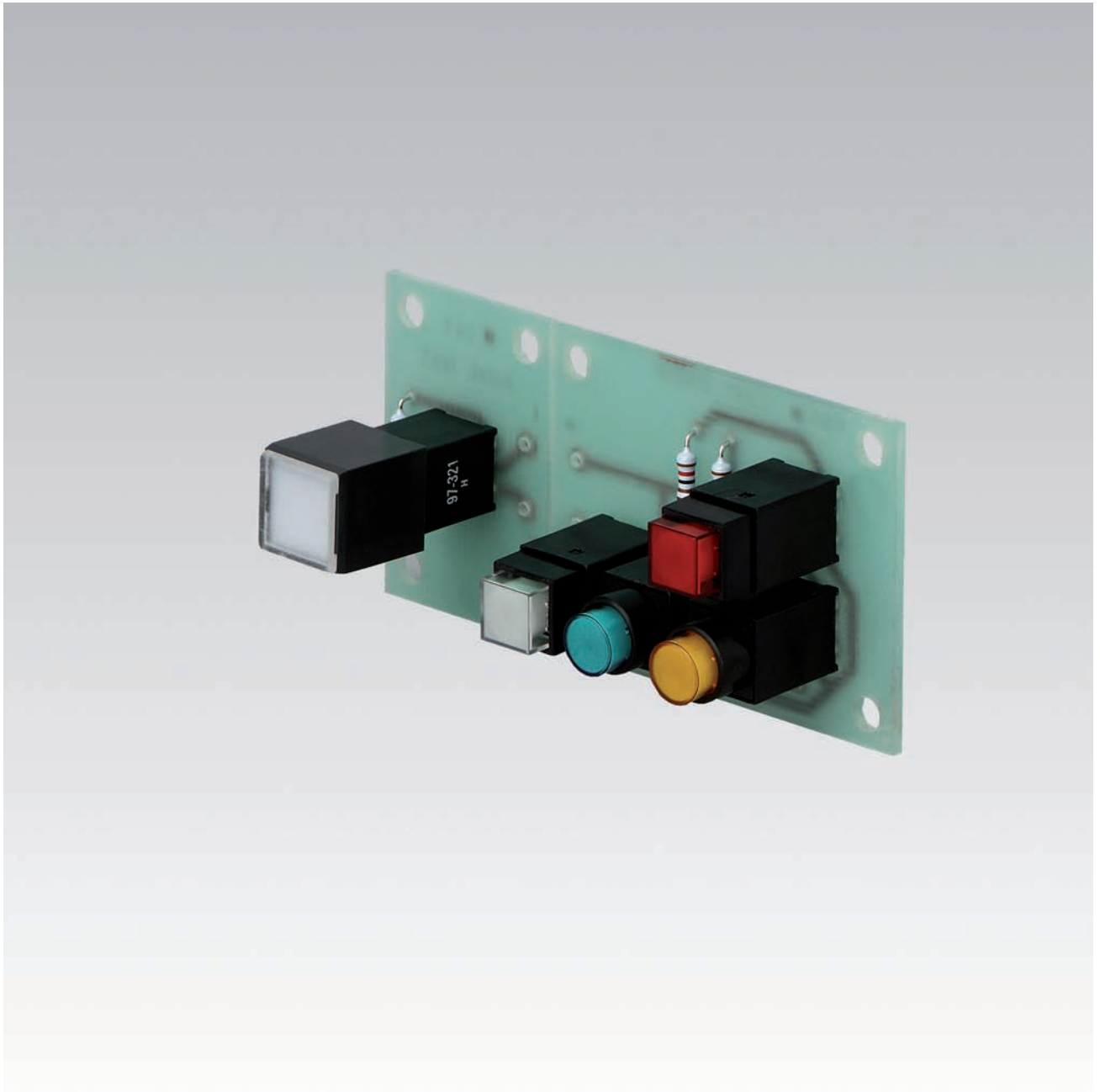

| | |
|-------------------------------|------------|
| Description | 19 |
| Product Assembly | 20 |
| PCB Pushbuttons | 21 |
| Accessories | 24 |
| Technical Data..... | 26 |
| Marking | 27 |
| Drawings..... | 28 |
| Index..... | 159 |

Product Information

General notes

The series 97 contains indicators and illuminated pushbuttons with maintained and momentary action with one or two contacts which may be either normally open or normally closed or a combination of the two. The illuminated pushbuttons are equipped with the low-level switching system.

The front dimensions are 9 x 9 mm or 9 mm dia.; or with overhanging lens 12.2 x 12.2 mm.

Mounting

The illuminated pushbuttons of series 97 can be soldered to a printed circuit board. The contact layout conforms to the module of 2.54 mm (1/10 "). A centering pin ensures dimensionally exact mounting in rows or blocks and prevents the button from lifting when being soldered.

Cleaning of soldered PCB

In many cases the boards are cleaned following mechanical soldering. In this case it is essential to prevent the cleaning fluid containing dirt, grease and flux from entering the switch.

Lenses

The flat lenses, made of polycarbonate, are obtainable in various colours. The transparent lens is available with translucent or transparent support.

The overhanging lenses consist of a lens bezel, a text plate and a mat transparent lens plate, obtainable in flat form.

Marking

For further information about engraving, hot stamping and film inserts see part Marking.

Illumination

Perfect illumination of the different coloured lenses is assured by LED Bi-Pin T 1 lamps. The LEDs are soldered through the pushbutton housing direct onto the PC boards.

Luminosity and wave length scattering caused by the technology used in the LED manufacturing processes may lead to visual differences in our products.

Position indication

The status of a maintained action switch can be determined by the position of the lens.

Specimen order

Indicator :

- Indicator actuator, 9 mm dia. 97-061.007

Essential accessories :

- Lens, plastic blue transparent flush, 9 mm dia. 97-932.6
 - Single-LED T1 Bi-Pin, 2.2 VDC, 20 mA, yellow 10-2602.3174F

*We reserve the right to modify technical data
 All dimensions in mm*

Pushbutton illuminative





- 1 Lens plate
- 2 Marking plate
- 3 Lens bezel
- 4 Switching element

Indicator actuator



Essential Accessories:

-  Lens page 24
-  Single-LED page 25

| | Front protection | Terminals | □ 9 x 9 mm Typ-Nr. | ∅ 9 mm Typ-Nr. | Component layout | Mounting dimensions | Technical drawing | Circuit drawing | |
|---------------------------|------------------|-----------|-----------------------|-------------------|------------------|---------------------|-------------------|-----------------|-------|
| Indicator actuator | IP 40 | P | 97-081.007 | 97-061.007 | 1 | 1 | 1 | 1 | 0.002 |



Terminals: P = PCB terminal

Component layout from page 28, Mounting dimensions from page 28, Technical drawing from page 29, Circuit drawing from page 29

Indicator actuator overhanging



Essential Accessories:

-  Lens overhanging complete page 24
-  Single-LED for overhanging version page 25

| | Front protection | Terminals | □ 12.2 x 12.2 mm Typ-Nr. | Component layout | Mounting dimensions | Technical drawing | Circuit drawing | |
|---------------------------------------|------------------|-----------|-----------------------------|------------------|---------------------|-------------------|-----------------|-------|
| Indicator actuator overhanging | IP 40 | P | 97-041.007 | 1 | 2 | 2 | 1 | 0.002 |

Terminals: P = PCB terminal

Component layout from page 28, Mounting dimensions from page 28, Technical drawing from page 29, Circuit drawing from page 29

Illuminated pushbutton actuator



Essential Accessories:

- Lens page 24
- Single-LED page 25

| | Front protection | Contacts | Switching action | Terminals | 9 x 9 mm Typ-Nr. | Ø 9 mm Typ-Nr. | Component layout | Mounting dimensions | Technical drawing | Circuit drawing | |
|--|------------------|-------------|------------------|-----------|---------------------|-------------------|------------------|---------------------|-------------------|-----------------|-------|
| Illuminated pushbutton actuator | IP 40 | 1 NC | MA | P | 97-382.037 | 97-372.037 | 2 | 1 | 1 | 2 | 0.002 |
| | | | M | P | 97-352.037 | 97-332.037 | 2 | 1 | 1 | 6 | 0.002 |
| | | 1 NC + 1 NO | MA | P | 97-383.037 | 97-373.037 | 2 | 1 | 1 | 3 | 0.002 |
| | | | M | P | 97-353.037 | 97-333.037 | 2 | 1 | 1 | 7 | 0.002 |
| | | 1 NO | MA | P | 97-380.037 | 97-370.037 | 2 | 1 | 1 | 5 | 0.002 |
| | | | M | P | 97-350.037 | 97-330.037 | 2 | 1 | 1 | 9 | 0.002 |
| | | 2 NO | MA | P | 97-381.037 | 97-371.037 | 2 | 1 | 1 | 4 | 0.002 |
| | | | M | P | 97-351.037 | 97-331.037 | 2 | 1 | 1 | 8 | 0.002 |

Contacts: NC = Normally closed, NO = Normally open

Switching action: MA = Maintained action, M = Momentary action



Terminals: P = PCB terminal

Component layout from page 28, Mounting dimensions from page 28, Technical drawing from page 29, Circuit drawing from page 29

Illuminated pushbutton actuator overhanging



Essential Accessories:

-  Lens overhanging complete page 24
-  Single-LED for overhanging version page 25

| | Front protection | Contacts | Switching action | Terminals | Ø 12.2 x 12.2 mm Typ-Nr. | Component layout | Mounting dimensions | Technical drawing | Circuit drawing |  |
|--|------------------|-------------|------------------|-----------|-----------------------------|------------------|---------------------|-------------------|-----------------|---|
| Illuminated pushbutton actuator overhanging | IP 40 | 1 NC | MA | P | 97-362.037 | 2 | 2 | 2 | 2 | 0.002 |
| | | | M | P | 97-322.037 | 2 | 2 | 2 | 6 | 0.002 |
| | | 1 NC + 1 NO | MA | P | 97-363.037 | 2 | 2 | 2 | 3 | 0.002 |
| | | | M | P | 97-323.037 | 2 | 2 | 2 | 7 | 0.002 |
| | | 1 NO | MA | P | 97-360.037 | 2 | 2 | 2 | 5 | 0.002 |
| | | | M | P | 97-320.037 | 2 | 2 | 2 | 9 | 0.002 |
| | | 2 NO | MA | P | 97-361.037 | 2 | 2 | 2 | 4 | 0.002 |
| | | | M | P | 97-321.037 | 2 | 2 | 2 | 8 | 0.002 |

Contacts: NC = Normally closed, NO = Normally open

Switching action: MA = Maintained action, M = Momentary action

Terminals: P = PCB terminal

Component layout from page 28, Mounting dimensions from page 28, Technical drawing from page 29, Circuit drawing from page 29

Front

Lens

| | Lens | Lens holder | ∅ 9 x 9 mm Typ-Nr. | ∅ 9 mm Typ-Nr. |  |
|--|------------------------------|-------------|-----------------------|-------------------|---|
| Lens Plastic (not for film insert and LED) | black opaque flush | translucent | 97-951.0 | 97-931.0 | 0.001 |
| | blue translucent flush | translucent | 97-951.6 | 97-931.6 | 0.001 |
| | green translucent flush | translucent | 97-951.5 | 97-931.5 | 0.001 |
| | grey opaque flush | translucent | 97-951.8 | 97-931.8 | 0.001 |
| | red translucent flush | translucent | 97-951.2 | 97-931.2 | 0.001 |
| | white translucent flush | translucent | 97-951.9 | 97-931.9 | 0.001 |
| | yellow translucent flush | translucent | 97-951.4 | 97-931.4 | 0.001 |
| Plastic (not recommended for film insert) | blue transparent flush | transparent | 97-952.6 | 97-932.6 | 0.001 |
| | colourless transparent flush | transparent | 97-952.7 | 97-932.7 | 0.001 |
| | green transparent flush | transparent | 97-952.5 | 97-932.5 | 0.001 |
| | red transparent flush | transparent | 97-952.2 | 97-932.2 | 0.001 |
| | yellow transparent flush | transparent | 97-952.4 | 97-932.4 | 0.001 |



Lens overhanging complete

for indicator and illuminated pushbutton overhanging

| | Lens plate | ∅ 12.2 x 12.2 mm Typ-Nr. |  |
|--|--------------------------------|-----------------------------|---|
| Lens overhanging complete flush, mat | Plastic colourless transparent | 97-910.9 | 0.001 |



Lens plate

for lens overhanging

| | Lens plate | ∅ 12.2 x 12.2 mm Typ-Nr. |  |
|---|--------------------------------|-----------------------------|---|
| Lens plate convex for film insert or marking plate flush, mat | Plastic colourless transparent | 97-929.7A | 0.001 |
| | Plastic blue transparent | 97-927.6 | 0.001 |
| | Plastic colourless transparent | 97-927.7 | 0.001 |
| | Plastic green transparent | 97-927.5 | 0.001 |
| | Plastic red transparent | 97-927.2 | 0.001 |
| | Plastic yellow transparent | 97-927.4 | 0.001 |
| flush for film insert or marking plate | Plastic blue transparent | 97-921.6 | 0.001 |
| | Plastic colourless transparent | 97-921.7 | 0.001 |
| | Plastic green transparent | 97-921.5 | 0.001 |
| | Plastic red transparent | 97-921.2 | 0.001 |
| | Plastic yellow transparent | 97-921.4 | 0.001 |



Marking plate

for lens overhanging

| | Marking plate | ∅ 12.2 x 12.2 mm Typ-Nr. |  |
|----------------------|---------------------------|-----------------------------|---|
| Marking plate | Plastic white translucent | 97-908.9 | 0.001 |



Marking foil

for lens overhanging

| | Marking foil | Typ-Nr. |  |
|---------------------|--------------|-----------------|---|
| Marking foil | colourless | 97-909.7 | 0.001 |

Lens bezel

for lens overhanging

| | Lens bezel | Typ-Nr. |  |
|------------------------------------|--------------|------------------|---|
| Lens bezel rounded edges | Plastic grey | 97-920.83 | 0.001 |
| Lens bezel with edges | Plastic grey | 97-920.8 | 0.001 |



Illumination

Single-LED

| | Socket | Light colour | Operating voltage/-current | Typ-Nr. |  |
|-------------------|-----------|--------------|----------------------------|----------------------|---|
| Single-LED | T1 Bi-Pin | green | 2.2 VDC, 20 mA | 10-2602.3175F | 0.001 |
| | | rot | 2.2 VDC, 20 mA | 10-2602.3172F | 0.001 |
| | | yellow | 2.2 VDC, 20 mA | 10-2602.3174F | 0.001 |



Single-LED for overhanging version

| | Socket | Light colour | Operating voltage/-current | Typ-Nr. |  |
|---|-----------|--------------|----------------------------|----------------------|---|
| Single-LED for overhanging version | T1 Bi-Pin | green | 2.2 VDC, 20 mA | 10-2602.3175G | 0.001 |
| | | red | 2.2 VDC, 20 mA | 10-2602.3172G | 0.001 |
| | | yellow | 2.2 VDC, 20 mA | 10-2602.3174G | 0.001 |



Assembling

Lens remover

for lens standard

| | Typ-Nr. |  |
|---------------------|---------------|---|
| Lens remover | 19-910 | 0.002 |



Actuator with low level switching element

Switching system

This low-level switching system was designed for switching low powers in electronic circuits. The switching system assures reliable switching of loads.

Single-break momentary contact, as normally open or normally closed with 4 independent points of contact.

Special features are the long life, extremely short rebound time and stable contact resistance.

Contact combinations: 1 normally open contact, 2 normally open contacts, 1 normally closed/1 normally open contact, 1 normally closed contact

Material

Lens

Polycarbonate (PC)

Switch housing

Polyester, self-extinguishing

Material of contact

Gold plated

Mechanical characteristics

Actuating force

3.4 N \pm 0.3 N (130 g)

Actuating travel

Lead distance NC contact: 0.6 mm \pm 0.2 mm

Lead distance NO contact: 1.6 mm \pm 0.2 mm

Total distance: 3 mm \pm 0.2 mm

Rebound time

typ. \leq 200 μ s

Mechanical lifetime

\leq 5 million operations, as per IEC 60512-5-9a

Electrical characteristics

Contact resistance

Starting value (initial) \leq 50 m Ω , as per IEC 60512-2-2b

Isolation resistance

\geq 10¹² Ω between contacts at 100 VDC, as per IEC 60512-2-3a

Electrical life

\geq 2 million operations at 30 VDC/100 mA, as per IEC 60512-5-9c

Switch rating

min. 100 μ VDC/AC, 10 μ A

max. 42 VDC/AC, 100 mA

Electric strength

500 VAC, 50 Hz, 1 min. between all terminals and earth, as per IEC 60512-2-11

Environmental conditions

Storage temperature

-40 °C ... +85 °C

Service temperature

-25 °C ... +65 °C

Front protection

IP 40 front side, as per IEC 60529

Shock resistance

(single impacts, semi-sinusoidal)

\geq 50 g for 11 ms, as per IEC 60512-4-3

Vibration resistance

(sinusoidal)

10 g at 10-2000 Hz, amplitude 0.75 mm, as per IEC 60512-4-4

General notes

1. Engraving

In addition to the most commonly used world languages, in DIN 1451-3 close spacing, other typefaces are available as Scandinavian, Slavic, Greek, Russian and Polish.

Unless requested otherwise by customer, the lettering on white marking plates will be in black.

Standard height of letters is 2 mm. If the height is not specified, we will supply 2 mm engraved letters.

2. Hot stamping

For larger series it is worth considering markings by means of hot stamping or laser engraving. We will be pleased to advise you.

For letters and figures, typefaces with 2.5 mm, 3 mm and 4 mm are available.

3. Film inserts for overhanging lens

Instead of using engraving the lenses can be fitted with transparent film inserts, placed between the lens plate and the marking plate.

The film thickness is 0.2 mm.

Maximum film size 10 x 10 mm.

Lenses for Indicators | Illuminated pushbuttons

All dimensions in mm

| Height of letters h | Number of lines | Number of (target value) capital letters per line | Number of (target value) small letters per line |
|------------------------|-----------------|--|--|
| 2 | 3 | 6 | 7 |
| 3 | 2 | 5 | 6 |
| 4 | 2 | 4 | 4 |
| 5 | 1 | 3 | 3 |
| 6 | 1 | 2 | 3 |
| 8 | 1 | 1 | 1 |

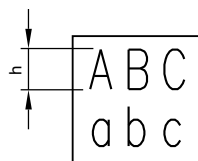

Component layout

1 Indicator actuator page 21 | Indicator actuator overhanging page 21

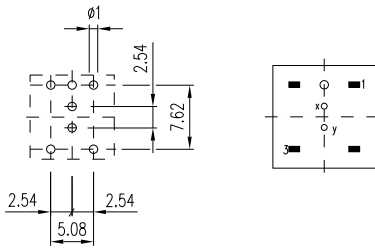

2 Illuminated pushbutton actuator page 22 | Illuminated pushbutton actuator overhanging page 23

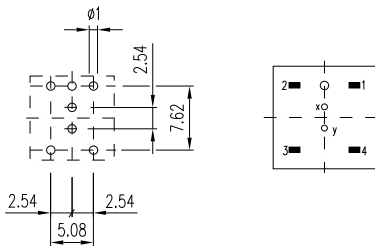

Mounting dimensions

1 Indicator actuator page 21 | Illuminated pushbutton actuator page 22

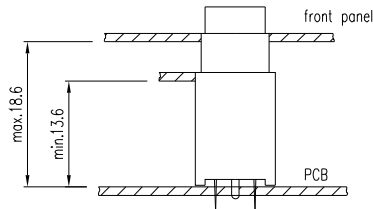
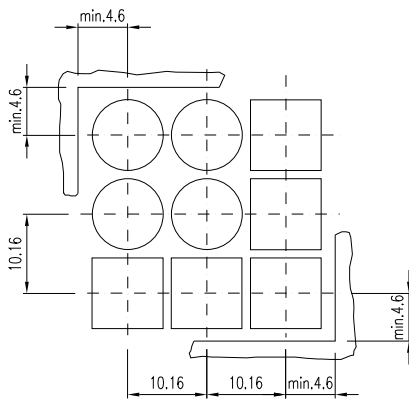

2 Indicator actuator overhanging page 21 | Illuminated pushbutton actuator overhanging page 23

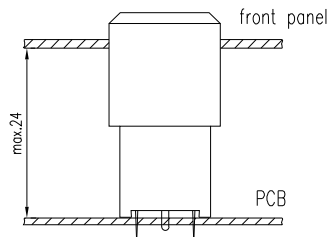
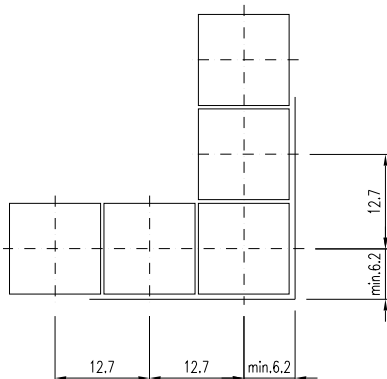

Technical drawing

1 Indicator actuator page 21 | Illuminated pushbutton actuator page 22

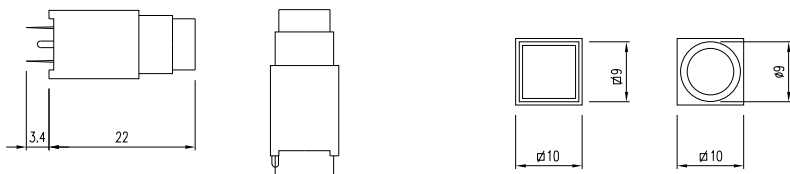

2 Indicator actuator overhanging page 21 | Illuminated pushbutton actuator overhanging page 23

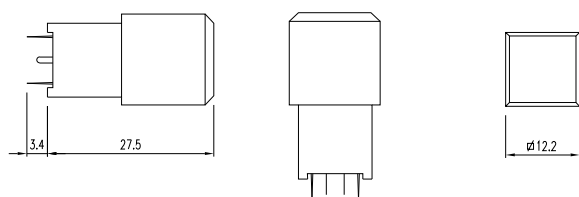

Circuit drawing

1 Indicator actuator page 21 | Indicator actuator overhanging page 21



2 Illuminated pushbutton actuator page 22 | Illuminated pushbutton actuator overhanging page 23

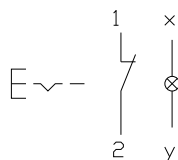

3 Illuminated pushbutton actuator page 22 | Illuminated pushbutton actuator overhanging page 23

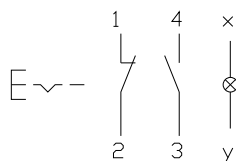

4 Illuminated pushbutton actuator page 22 | Illuminated pushbutton actuator overhanging page 23

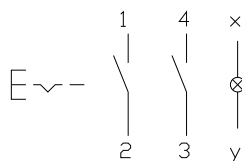

5 Illuminated pushbutton actuator page 22 | Illuminated pushbutton actuator overhanging page 23

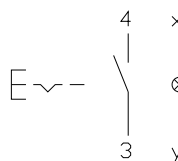

6 Illuminated pushbutton actuator page 22 | Illuminated pushbutton actuator overhanging page 23

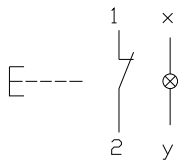

7 Illuminated pushbutton actuator page 22 | Illuminated pushbutton actuator overhanging page 23

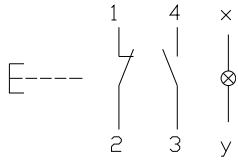

8 Illuminated pushbutton actuator page 22 | Illuminated pushbutton actuator overhanging page 23

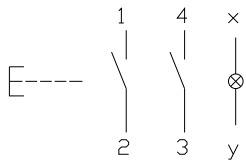

9 Illuminated pushbutton actuator page 22 | Illuminated pushbutton actuator overhanging page 23

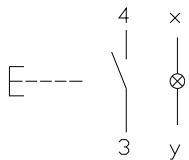

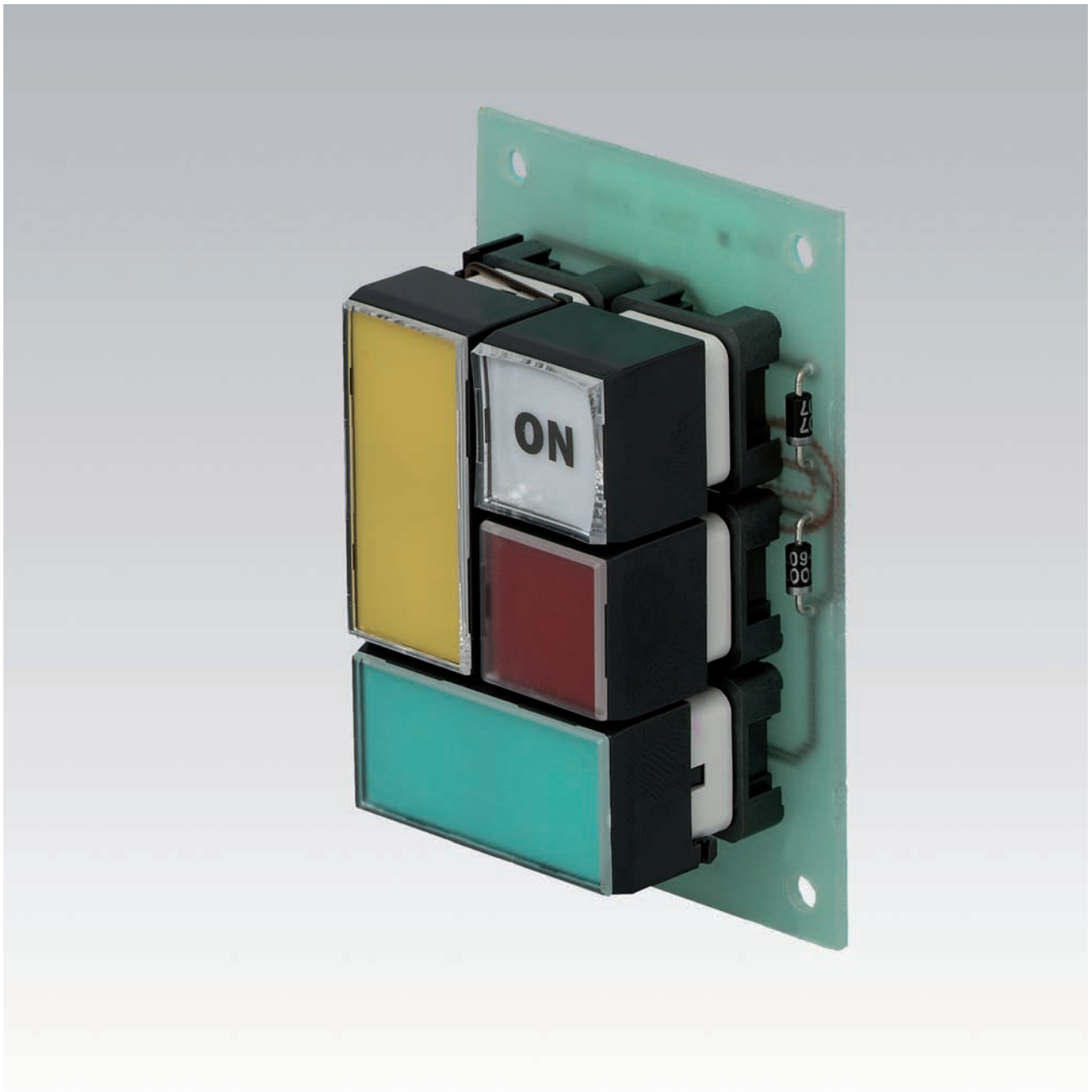

| | |
|-------------------------------|------------|
| Description | 33 |
| Product Assembly | 34 |
| PCB Pushbuttons | 35 |
| Accessories | 40 |
| Technical Data..... | 44 |
| Marking | 45 |
| Drawings..... | 46 |
| Index..... | 159 |

Product Information

General notes

The series 99 contains indicators and illuminated pushbuttons with maintained and momentary action with one or two contacts which may be either normally open or normally closed or a combination of the two. The illuminated pushbuttons are equipped with the low-level switching system.

The series 99 PCB keylock switch with a spacing of 19.05 mm completes the existing range of indicators and illuminated pushbuttons. The PCB keylock switch is available with two and three positions, with maintained action, and with either one or two normally open contacts as well as with one normally open and one normally closed one.

Mounting

The illuminated pushbuttons of series 99 can be soldered to a printed circuit board. The contact layout conforms to the module of 2.54 mm (1/10 "). A centering pin ensures dimensionally exact mounting in rows or blocks. With an M1.2 screw the pushbuttons can also be fixed to a printed circuit board. (This screw must be ordered separately.) The pushbuttons can be joined together easily with a coupling piece to form rows or blocks. The layout of the PCB keylock switch conforms to the module of 2.54 mm (1/10 "). Two centering pins ensure a dimensionally exact mounting. The contact layout corresponds to that of series 99 switches.

Cleaning of soldered PCB

In many cases the boards are cleaned following mechanical soldering. In this case it is essential to prevent the cleaning fluid containing dirt, grease and flux from entering the switch.

Lenses

The lens consists of a bezel, a marking plate and a transparent lens plate, which may be either flush or concave.

Marking

For further information about engraving, hot stamping and film inserts see part Marking.

Illumination

Illumination of the different coloured lenses is by lamps Bi-Pin T1 longlife (6 ... 36 V) or LED Bi-Pin T1. Luminosity and wave length scattering caused by the technology used in the LED manufacturing processes may lead to visual differences in our products.

Position indication

The status of a maintained action switch can be determined by the position of the lens.

Keylock switch

Standard lock (Index D). 10 different locks with standard nos. 311 ... 320. If the lock number is not specified, we supply no. 311. Additional 125 locks, no. 321 ... 445, are available on request. Master keys for locks no. 311 ... 445 may be ordered by quoting no. 31-989.300. Two keys are supplied with each keylock switch. Spare keys for standard DOM locks may be ordered by quoting no. 31-989 (please state the lock number).

Specimen order

Indicator :

- Indicator actuator single, 18.6 x 18.6 mm 99-050.807

Essential accessories :

- Lens single complete, plastic colourless transparent flush, 18.6 x 18.6 mm 99-901.9
 - Single-LED T1 Bi-Pin, 2.2 VDC, 20 mA, yellow 10-2602.3174C

*We reserve the right to modify technical data
 All dimensions in mm*

Pushbutton illuminative

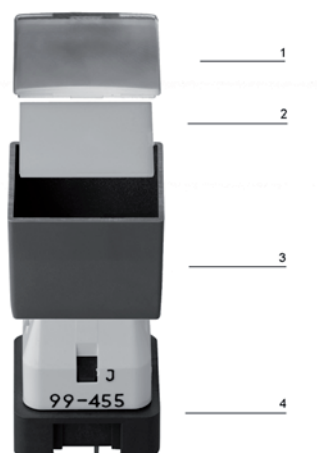



- 1 Lens plate
- 2 Marking plate
- 3 Lens bezel
- 4 Switching element

Indicator actuator single



Essential Accessories:

-  Lens single, complete page 40
-  Single-LED page 43

| | Front protection | Terminals | 18.6 x 18.6 Typ-Nr. | Component layout | Mounting dimensions | Technical drawing | Circuit drawing | |
|----------------------------------|------------------|-----------|------------------------|------------------|---------------------|-------------------|-----------------|-------|
| Indicator actuator single | IP 40 | P | 99-050.807 | 1 | 1 | 1 | 1 | 0.006 |



Terminals: P = PCB terminal

Component layout from page 46, Mounting dimensions from page 47, Technical drawing from page 48, Circuit drawing from page 49

Indicator actuator double



Essential Accessories:

-  Lens plate double page 41
-  Marking plate double page 41
-  Single-LED page 43

| | Front protection | Terminals | 18.6 x 37.8 mm Typ-Nr. | Component layout | Mounting dimensions | Technical drawing | Circuit drawing | |
|----------------------------------|------------------|-----------|---------------------------|------------------|---------------------|-------------------|-----------------|-------|
| Indicator actuator double | IP 40 | P | 99-052.807 | 2 | 1 | 2 | 22 | 0.011 |



Terminals: P = PCB terminal

Component layout from page 46, Mounting dimensions from page 47, Technical drawing from page 48, Circuit drawing from page 49

Indicator actuator triple



Essential Accessories:

-  Lens plate triple page 41
-  Marking plate triple page 41
-  Single-LED page 43

| | Front protection | Terminals | Dimensions □ 18.6 x 56.9 mm Typ-Nr. | Component layout | Mounting dimensions | Technical drawing | Circuit drawing | |
|----------------------------------|------------------|-----------|---|------------------|---------------------|-------------------|-----------------|-------|
| Indicator actuator triple | IP 40 | P | 99-053.807 | 3 | 1 | 3 | 23 | 0.017 |



Terminals: P = PCB terminal

Component layout from page 46, Mounting dimensions from page 47, Technical drawing from page 48, Circuit drawing from page 49

Illuminated pushbutton actuator single



Essential Accessories:

-  Lens single, complete page 40
-  Single-LED page 43

| | Front protection | Contacts | Switching action | point of pressure | Terminals | 18.6 x 18.6 mm Typ-Nr. | Component layout | Mounting dimensions | Technical drawing | Circuit drawing | |
|--|------------------|-------------|------------------|-------------------|-----------|---------------------------|------------------|---------------------|-------------------|-----------------|-------|
| Illuminated pushbutton actuator single | IP 40 | 1 NC | MA | with | P | 99-482.837 | 1 | 1 | 1 | 2 | 0.008 |
| | | | | without | P | 99-487.837 | 1 | 1 | 1 | 2 | 0.008 |
| | | | M | with | P | 99-452.837 | 1 | 1 | 1 | 10 | 0.008 |
| | | | | without | P | 99-457.837 | 1 | 1 | 1 | 10 | 0.008 |
| | | 1 NC + 1 NO | MA | with | P | 99-483.837 | 1 | 1 | 1 | 4 | 0.008 |
| | | | | without | P | 99-488.837 | 1 | 1 | 1 | 4 | 0.008 |
| | | | M | with | P | 99-453.837 | 1 | 1 | 1 | 12 | 0.008 |
| | | | | without | P | 99-458.837 | 1 | 1 | 1 | 12 | 0.008 |
| | | 1 NO | MA | with | P | 99-480.837 | 1 | 1 | 1 | 3 | 0.008 |
| | | | | without | P | 99-485.837 | 1 | 1 | 1 | 3 | 0.008 |
| | | | M | with | P | 99-450.837 | 1 | 1 | 1 | 11 | 0.008 |
| | | | | without | P | 99-455.837 | 1 | 1 | 1 | 11 | 0.008 |
| | | 2 NO | MA | with | P | 99-481.837 | 1 | 1 | 1 | 7 | 0.008 |
| | | | | without | P | 99-486.837 | 1 | 1 | 1 | 7 | 0.008 |
| | | | M | with | P | 99-451.837 | 1 | 1 | 1 | 15 | 0.008 |
| | | | | without | P | 99-456.837 | 1 | 1 | 1 | 15 | 0.008 |

Contacts: NC = Normally closed, NO = Normally open

Switching action: MA = Maintained action, M = Momentary action



Terminals: P = PCB terminal

Component layout from page 46, Mounting dimensions from page 47, Technical drawing from page 48, Circuit drawing from page 49

Illuminated pushbutton actuator double



Essential Accessories:

-  Lens plate double page 41
-  Marking plate double page 41
-  Single-LED page 43

| | Front protection | Contacts | Switching action | Terminals | □ 18.6 x 37.8 Typ-Nr. | Component layout | Mounting dimensions | Technical drawing | Circuit drawing |  |
|---|------------------|-------------|------------------|-----------|--------------------------|------------------|---------------------|-------------------|-----------------|---|
| Illuminated pushbutton actuator double | IP 40 | 1 NC + 1 NO | MA | P | 99-418.837 | 2 | 1 | 2 | 5 | 0.013 |
| | | | M | P | 99-408.837 | 2 | 1 | 2 | 13 | 0.013 |
| | | 2 NO | MA | P | 99-416.837 | 2 | 1 | 2 | 8 | 0.013 |
| | | | M | P | 99-406.837 | 2 | 1 | 2 | 16 | 0.013 |

Contacts: NC = Normally closed, NO = Normally open

Switching action: MA = Maintained action, M = Momentary action



Terminals: P = PCB terminal

Component layout from page 46, Mounting dimensions from page 47, Technical drawing from page 48, Circuit drawing from page 49

Illuminated pushbutton actuator triple



Essential Accessories:

-  Lens plate triple page 41
-  Marking plate triple page 41
-  Single-LED page 43

| | Front protection | Contacts | Switching action | Terminals | □ 18.6 x 56.9 Typ-Nr. | Component layout | Mounting dimensions | Technical drawing | Circuit drawing |  |
|---|------------------|-------------|------------------|-----------|--------------------------|------------------|---------------------|-------------------|-----------------|---|
| Illuminated pushbutton actuator triple | IP 40 | 1 NC + 1 NO | MA | P | 99-448.837 | 3 | 1 | 3 | 6 | 0.019 |
| | | | M | P | 99-438.837 | 3 | 1 | 3 | 14 | 0.019 |
| | | 2 NO | MA | P | 99-446.837 | 3 | 1 | 3 | 9 | 0.019 |
| | | | M | P | 99-436.837 | 3 | 1 | 3 | 17 | 0.019 |

Contacts: NC = Normally closed, NO = Normally open

Switching action: MA = Maintained action, M = Momentary action

Terminals: P = PCB terminal

Component layout from page 46, Mounting dimensions from page 47, Technical drawing from page 48, Circuit drawing from page 49

Keylock switch 2 positions

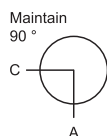

| | Front protection | Contacts | Switching action | Terminals | Key remove | Ø 18.8 x 18.8 mm Typ-Nr. | Component layout | Mounting dimensions | Technical drawing | Circuit drawing | | |
|---|------------------|-------------|------------------|-----------|--------------------|-----------------------------|------------------|---------------------|-------------------|-----------------|-------|-------|
| | | | | | | | 1 | 2 | 4 | 20 | | 0.017 |
| Keylock switch 2 positions Position A: Basic position Position C: Maintained action Standard lock 311 | IP 40 | 1 NC + 1 NO | MA | P | A | 99-213.837D | 1 | 2 | 4 | 20 | 0.017 | |
| | | | | | C | 99-233.837D | 1 | 2 | 4 | 20 | 0.017 | |
| | | | | | C + A | 99-253.837D | 1 | 2 | 4 | 20 | 0.017 | |
| | | 1 NO | MA | P | A | 99-210.837D | 1 | 2 | 4 | 18 | 0.017 | |
| | | | | | C | 99-230.837D | 1 | 2 | 4 | 18 | 0.017 | |
| | | | | | C + A | 99-250.837D | 1 | 2 | 4 | 18 | 0.017 | |
| | 2 NO | MA | P | A | 99-211.837D | 1 | 2 | 4 | 21 | 0.017 | | |
| | | | | C | 99-231.837D | 1 | 2 | 4 | 21 | 0.017 | | |
| | | | | C + A | 99-251.837D | 1 | 2 | 4 | 21 | 0.017 | | |

Other lock numbers on request

Contacts: NC = Normally closed, NO = Normally open

Switching action: MA = Maintained action

Terminals: P = PCB terminal

Component layout from page 46, Mounting dimensions from page 47, Technical drawing from page 48, Circuit drawing from page 49

Keylock switch 3 positions

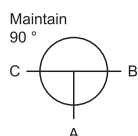

| | Front protection | Contacts | Switching action | Terminals | Key remove | Ø 18.8 x 18.8 mm Typ-Nr. | Component layout | Mounting dimensions | Technical drawing | Circuit drawing | | |
|--|------------------|----------|------------------|-----------|------------|-----------------------------|------------------|---------------------|-------------------|-----------------|-------|-------|
| | | | | | | | 1 | 2 | 4 | 19 | | 0.017 |
| Keylock switch 3 positions Position C: Maintained action Position A: Basic position Position B: Maintained action Standard lock 311 | IP 40 | 2 NO | MA-0-MA | P | A | 99-311.837D | 1 | 2 | 4 | 19 | 0.017 | |
| | | | | | A + B | 99-341.837D | 1 | 2 | 4 | 19 | 0.017 | |
| | | | | | B | 99-321.837D | 1 | 2 | 4 | 19 | 0.017 | |
| | | | | | C | 99-331.837D | 1 | 2 | 4 | 19 | 0.017 | |
| | | | | | C + A | 99-351.837D | 1 | 2 | 4 | 19 | 0.017 | |
| | | | | | C + A + B | 99-371.837D | 1 | 2 | 4 | 19 | 0.017 | |
| | | | | | C + B | 99-361.837D | 1 | 2 | 4 | 19 | 0.017 | |

Other lock numbers on request

Contacts: NO = Normally open

Switching action: MA = Maintained action

Terminals: P = PCB terminal

Component layout from page 46, Mounting dimensions from page 47, Technical drawing from page 48, Circuit drawing from page 49

Front

Lens single, complete

for single pushbutton

| | Pressure plate | ∅ 18.6 x 18.6 mm Typ-Nr. |  |
|---|--------------------------------|-----------------------------|---|
| Lens single, complete concave | Plastic colourless transparent | 99-902.9 | 0.002 |
| flush | Plastic colourless transparent | 99-901.9 | 0.002 |



Lens plate single

for single pushbutton

| | Pressure plate | ∅ 18.6 x 18.6 mm Typ-Nr. |  |
|-------------------------------------|--------------------------------|-----------------------------|---|
| Lens plate single concave | Plastic colourless transparent | 99-922.7 | 0.001 |
| | Plastic grey opaque | 99-924.8 | 0.001 |
| concave, mat | Plastic colourless transparent | 99-928.7 | 0.001 |
| convex | Plastic colourless transparent | 99-929.7A | 0.001 |
| convex with recess | Plastic colourless transparent | 99-928.7A | 0.001 |
| flush | Plastic colourless transparent | 99-921.7 | 0.001 |
| flush, mat | Plastic colourless transparent | 99-927.7 | 0.001 |



Marking plate single

for lens single

| | Marking plate | ∅ 18.6 x 18.6 mm Typ-Nr. |  |
|---|---------------------------|-----------------------------|---|
| Marking plate single can be engraved or hot stamped | Plastic black translucent | 99-908.0 | 0.001 |
| | Plastic white translucent | 99-908.9 | 0.001 |
| for LED | Plastic beige translucent | 99-918.A | 0.001 |



Lens bezel single

for single pushbutton

| | Lens bezel | Typ-Nr. |  |
|-------------------------------------|---------------|------------------|---|
| Lens bezel single rounded | Plastic grey | 99-920.82 | 0.001 |
| | Plastic beige | 99-920.9B | 0.001 |
| with edges | Plastic black | 99-920.0 | 0.001 |
| | Plastic brown | 99-920.9C | 0.001 |
| | Plastic grey | 99-920.8 | 0.001 |
| | Plastic white | 99-920.9A | 0.001 |



Lens plate double

for pushbutton double

| | Pressure plate | □ 18.6 x 37.8 mm Typ-Nr. |  |
|-------------------------------------|--------------------------------|-----------------------------|---|
| Lens plate double concave | Plastic colourless transparent | 99-962.7 | 0.001 |
| concave, mat | Plastic colourless transparent | 99-974.7 | 0.001 |
| flush | Plastic colourless transparent | 99-961.7 | 0.001 |
| | Plastic white transparent | 99-961.9 | 0.001 |
| flush, mat | Plastic colourless transparent | 99-973.7 | 0.001 |



Marking plate double

for lens double

| | Marking plate | □ 18.6 x 37.8 mm Typ-Nr. |  |
|---|---------------------------|-----------------------------|---|
| Marking plate double can be engraved or hot stamped | Plastic black translucent | 99-963.0 | 0.001 |
| | Plastic white translucent | 99-963.9 | 0.001 |



Lens plate triple

for pushbutton triple

| | Pressure plate | □ 18.6 x 56.9 mm Typ-Nr. |  |
|-------------------------------------|--------------------------------|-----------------------------|---|
| Lens plate triple concave | Plastic colourless transparent | 99-967.7 | 0.002 |
| concave, mat | Plastic colourless transparent | 99-979.7 | 0.002 |
| flush | Plastic colourless transparent | 99-966.7 | 0.002 |
| flush, mat | Plastic colourless transparent | 99-978.7 | 0.002 |



Marking plate triple

for pushbutton triple

| | Marking plate | □ 18.6 x 56.9 mm Typ-Nr. |  |
|---|---------------------------|-----------------------------|---|
| Marking plate triple can be engraved or hot stamped | Plastic black translucent | 99-968.0 | 0.001 |
| | Plastic white translucent | 99-968.9 | 0.001 |



Colour foil single

for lens single

| | Colour foil | □ 18.6 x 18.6 mm Typ-Nr. |  |
|---------------------------|-------------|-----------------------------|---|
| Colour foil single | blue | 99-909.6 | 1.001 |
| | green | 99-909.5 | 1.001 |
| | orange | 99-909.3 | 1.001 |
| | red | 99-909.2 | 1.001 |
| | yellow | 99-909.4 | 1.001 |



Colour foil double

for lens double

| | Colour foil | □ 18.6 x 37.8 mm Typ-Nr. |  |
|---------------------------|-------------|-----------------------------|---|
| Colour foil double | blue | 99-964.6 | 0.001 |
| | green | 99-964.5 | 0.001 |
| | red | 99-964.2 | 0.001 |
| | yellow | 99-964.4 | 0.001 |



Colour foil triple

for lens triple

| | Colour foil | □ 18.6 x 56.9 mm Typ-Nr. |  |
|---------------------------|-------------|-----------------------------|---|
| Colour foil triple | blue | 99-969.6 | 0.001 |
| | green | 99-969.5 | 0.001 |
| | red | 99-969.2 | 0.001 |
| | yellow | 99-969.4 | 0.001 |



Blind plug

| | Blind plug | □ 19 x 19 mm Typ-Nr. |  |
|--------------------------------|--------------|-------------------------|---|
| Blind plug H = 16 mm | Plastic grey | 99-948.81 | 0.003 |
| H = 17.5 mm | Plastic grey | 99-948.82 | 0.003 |
| H = 19 mm | Plastic grey | 99-948.83 | 0.004 |



Spare key

| | Typ-Nr. |  |
|--|-------------------|---|
| Spare key Key lock switch, standard lock 311 (DOM) | 31-989.311 | 0.006 |



Other lock numbers on request

Illumination

Filament lamp

up to pushbutton order 1, 2 or 3 pcs.

| | Socket | Operating voltage/-current | Typ-Nr. |  |
|----------------------|-----------|----------------------------|---------------------|---|
| Filament lamp | T1 Bi-Pin | 12 VAC/DC, 25 mA | 10-1609.1199 | 0.001 |
| | | 24 VAC/DC, 20 mA | 10-1612.1179 | 0.001 |
| | | 28 VAC/DC, 24 mA | 10-1613.1189 | 0.001 |
| | | 36 VAC/DC, 20 mA | 10-1616.1179 | 0.001 |
| | | 6 VAC/DC, 70 mA | 10-1606.1309 | 0.001 |



Single-LED

up to pushbutton order 1, 2 or 3 pcs.

| | Socket | Light colour | Operating voltage/-current | Typ-Nr. |  |
|-------------------|-----------|--------------|----------------------------|----------------------|---|
| Single-LED | T1 Bi-Pin | green | 2.2 VDC, 20 mA | 10-2602.3175C | 0.001 |
| | | red | 2.2 VDC, 20 mA | 10-2602.3172C | 0.001 |
| | | white | 3.6 VDC, 20 mA | 10-2603.3179C | 0.001 |
| | | yellow | 2.2 VDC, 20 mA | 10-2602.3174C | 0.001 |



Multi-LED

up to pushbutton order 1, 2 or 3 pcs.

| | Socket | Light colour | Operating voltage/-current | Typ-Nr. |  |
|------------------|-----------|--------------|----------------------------|----------------------|---|
| Multi-LED | T1 Bi-Pin | green | 28 VDC, 12 mA | 10-4613.3105B | 0.001 |
| | | orange | 28 VDC, 12 mA | 10-4613.3103B | 0.001 |
| | | red | 28 VDC, 12 mA | 10-4613.3102B | 0.001 |
| | | yellow | 28 VDC, 12 mA | 10-4613.3104B | 0.001 |



Assembling

Coupling section

for mounting pushbuttons in rows or blocks

| | Typ-Nr. |  |
|---------------------------------|---------------|---|
| Coupling section grey | 99-910 | 0.001 |



Fixing screw

| | Typ-Nr. |  |
|---|---------------|---|
| Fixing screw M 1.2 x 5 mm (DIN) | 99-990 | 0.001 |

Lamp remover

| | Typ-Nr. |  |
|---------------------|---------------|---|
| Lamp remover | 11-906 | 0.003 |



CAUTION

A switching process might be released when replacing the Lamp/LED !

Low level switching element

Switching system

This low-level switching system was designed for switching low powers in electronic circuits. The switching system assures reliable switching of loads.

Single-break momentary contact, as normally open or normally closed with 4 independent points of contact.

Special features are the long life, extremely short rebound time and stable contact resistance.

Contact combinations: 1 normally open contact, 2 normally open contacts, 1 normally closed/1 normally open contact, 1 normally closed contact

Material

Material of contact

Gold plated

Switching element

Polycarbonate (PC)

Mechanical characteristics

Rebound time

≤100 μs typical

Mechanical lifetime

| | |
|------------------------|----------------------|
| Illuminated pushbutton | 5 million operations |
| PCB keylock switch | 50 000 operations |

Electrical characteristics

Contact resistance

Starting value (initial) ≤50 mΩ as per IEC 60512-2-2b

Isolation resistance

10¹² Ω between contacts at 100 VDC, as per IEC 60512-2-3a

Switch rating

min. 100 μVDC/AC, 10 μA
max. 42 VDC/AC, 100 mA

Electric strength

2500 VAC, 50 Hz, 1 min. between all terminals and earth, as per IEC 60512-2-11

Environmental conditions

Storage temperature

-40 °C ... +85 °C

Service temperature

-25 °C ... +55 °C
for indicators and illuminated pushbuttons mounted as a block, make sure the heat can escape freely

Shock resistance

(single impacts, semi-sinusoidal)
15 g for 11 ms as per IEC 6068-2-27

Actuator

Material

Lens plate

Polymethylmethacrylate (PMMA), heat-resistant

Lens bezel

Polycarbonate (PC), heat-resistant

Mechanical characteristics

Actuating torque

4.7 Ncm ... 6.0 Ncm (measured at the key)

Actuating force

| | |
|----------------------------------|------------|
| Pushbutton with tactile point | 2.0 ±0.3 N |
| Pushbutton without tactile point | 1.3 ±0.4 N |

Actuating travel

Lead distance NC contact 1.1 ±0.2 mm
Lead distance NO contact 2.1 ±0.2 mm
total distance 3.6 ±0.2 mm

Angle of rotation for print keylock switch

Keylock switch with 2 positions 90°
Keylock switch with 3 positions 2 x 90°

Mechanical lifetime

| | |
|------------------------|----------------------|
| Illuminated pushbutton | 5 million operations |
| PCB keylock switch | 50 000 operations |

Electrical characteristics

Electrostatic discharge (ESD)

10 kV

Environmental conditions

Storage temperature

-40 °C ... +85 °C

Service temperature

-25 °C ... +55 °C
for indicators and illuminated pushbuttons mounted as a block, make sure the heat can escape freely

Protection degree

frontside IP 40, PCB keylock switch, illuminated pushbutton

General notes

1. Engraving

In addition to the most commonly used world languages, in DIN 1451-3 close spacing, other typefaces are available as Scandinavian, Slavic, Greek, Russian and Polish.

Unless requested otherwise by customer, the lettering on white and black marking plates will be in black or white.

Standard height of letters is 2 mm. If the height is not specified, we will supply 2 mm engraved letters.

2. Hot stamping

For larger series it is worth considering markings by means of hot stamping or laser engraving. We will be pleased to advise you. For letters and figures, typefaces with 2.5 mm, 3 mm and 4 mm are available.

3. Film inserts

Instead of using engraving the lenses can be fitted with transparent film inserts, possibly backed by a colour foil placed between the lens plate and the marking plate, as an alternative.

The film thickness is 0.2 mm.

Maximum film size:

for single pushbutton 16 x 16 mm

for double pushbutton 16 x 34.7 mm

for triple pushbutton 16 x 53.8 mm.

Lenses for Indicators | Illuminated pushbuttons

All dimensions in mm

| Front size | Film insert max. size | Height of letters h | Number of lines | Number of (target value) capital letters per line | Number of (target value) small letters per line | Image |
|-------------|-----------------------|---------------------|-----------------|---|---|-------|
| 18.6 x 18.6 | 16 x 16 | 2 | 4 | 7 | 8 | B1 |
| | | 3 | 3 | 6 | 7 | B1 |
| | | 4 | 2 | 4 | 5 | B1 |
| | | 5 | 2 | 3 | 4 | B1 |
| | | 6 | 1 | 3 | 4 | B1 |
| | | 8 | 1 | 2 | 3 | B1 |
| 18.6 x 37.8 | 16 x 34.7 | 2 | 4 | 19 | 20 | B2 |
| | | 3 | 3 | 16 | 18 | B2 |
| | | 4 | 2 | 11 | 13 | B2 |
| | | 5 | 2 | 9 | 10 | B2 |
| | | 6 | 1 | 7 | 8 | B2 |
| | | 8 | 1 | 5 | 6 | B2 |
| 18.6 x 56.9 | 16 x 53.8 | 2 | 4 | 30 | 32 | B3 |
| | | 3 | 3 | 25 | 28 | B3 |
| | | 4 | 2 | 18 | 20 | B3 |
| | | 5 | 2 | 14 | 16 | B3 |
| | | 6 | 1 | 12 | 13 | B3 |
| | | 8 | 1 | 9 | 10 | B3 |

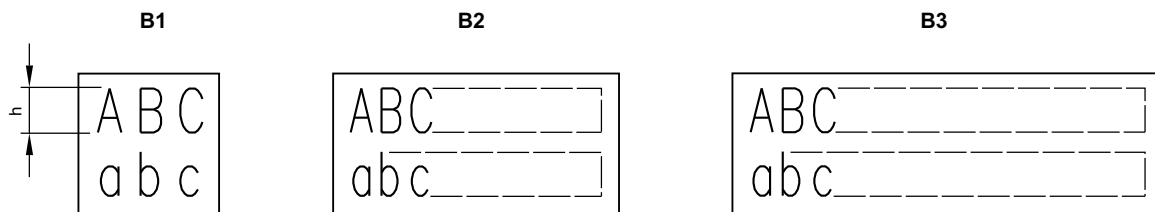

Component layout

1 Indicator actuator single page 35 | **Illuminated pushbutton actuator single** page 37 | **Keylock switch 2 positions** page 39 | **Keylock switch 3 positions** page 39

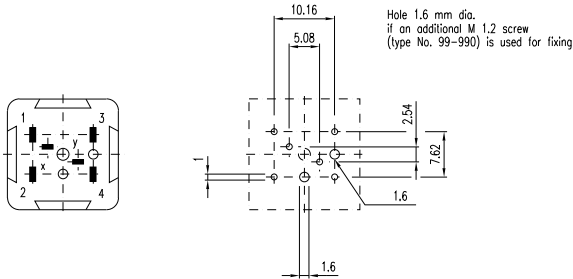

Libraries for the PCB layout-system p-cad 200X see : www.pcad.com/resources/libraries Third-party Libraries

2 Indicator actuator double page 35 | **Illuminated pushbutton actuator double** page 38

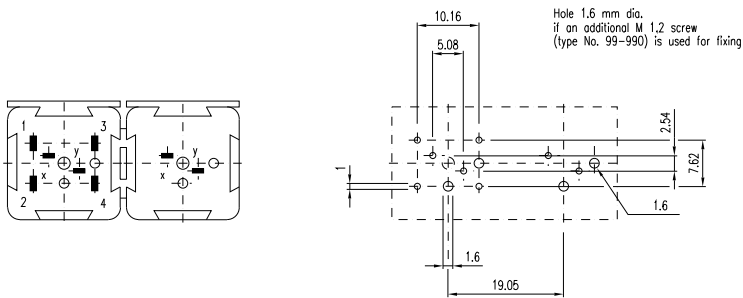

Libraries for the PCB layout-system p-cad 200X see : www.pcad.com/resources/libraries Third-party Libraries

3 Indicator actuator triple page 36 | **Illuminated pushbutton actuator triple** page 38

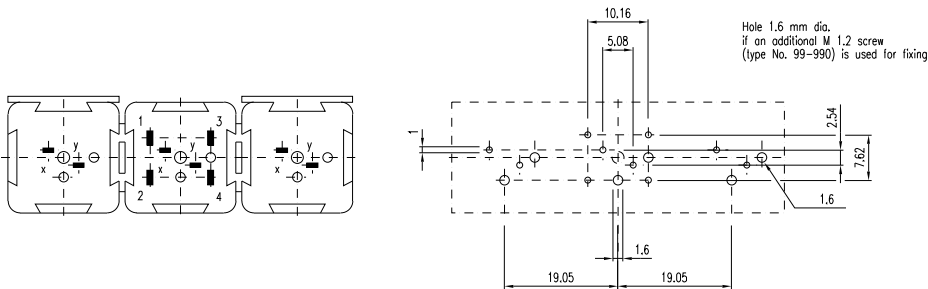

Libraries for the PCB layout-system p-cad 200X see : www.pcad.com/resources/libraries Third-party Libraries

Mounting dimensions

1 Indicator actuator single page 35 | Indicator actuator double page 35 | Indicator actuator triple page 36 | Illuminated pushbutton actuator single page 37 | Illuminated pushbutton actuator double page 38 | Illuminated pushbutton actuator triple page 38

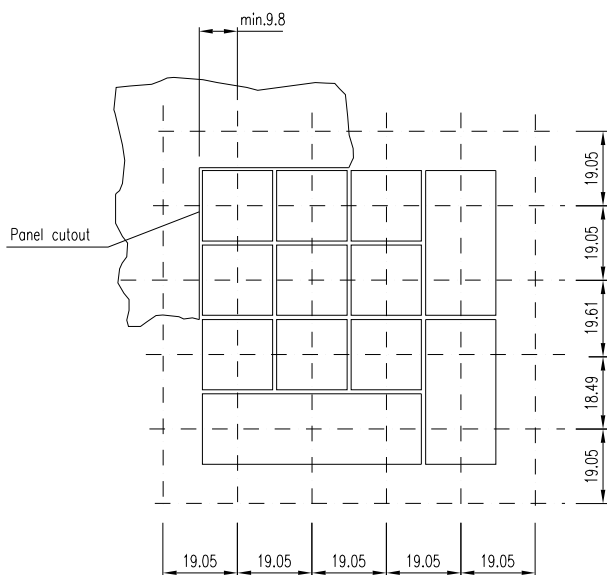

2 Keylock switch 2 positions page 39 | Keylock switch 3 positions page 39

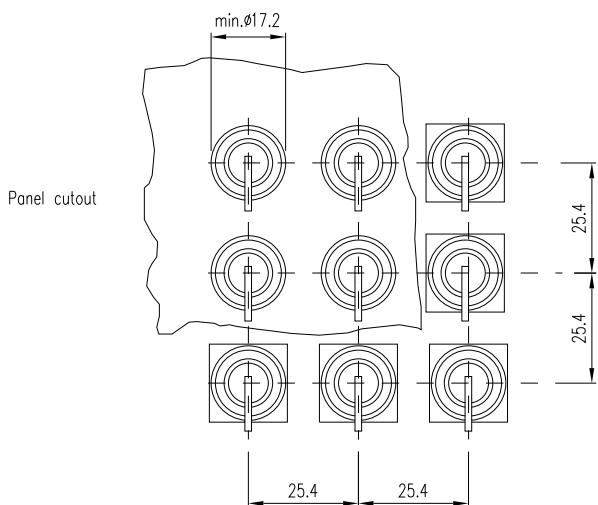

Technical drawing

1 Indicator actuator single page 35 | Illuminated pushbutton actuator single page 37

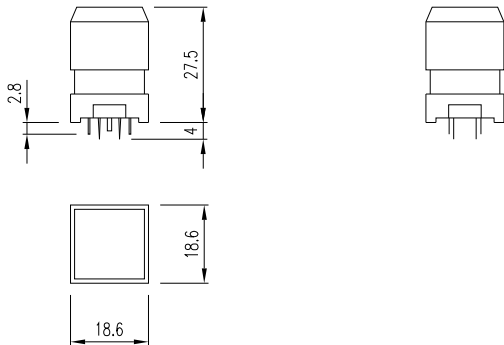

2 Indicator actuator double page 35 | Illuminated pushbutton actuator double page 38

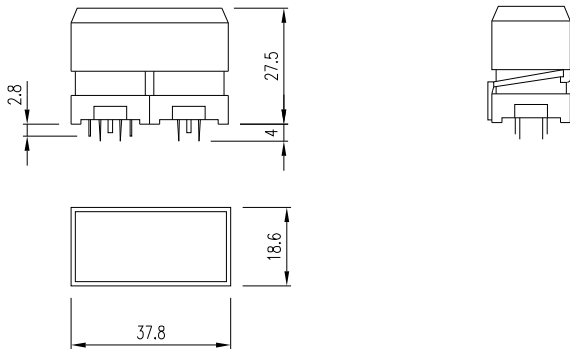

3 Indicator actuator triple page 36 | Illuminated pushbutton actuator triple page 38

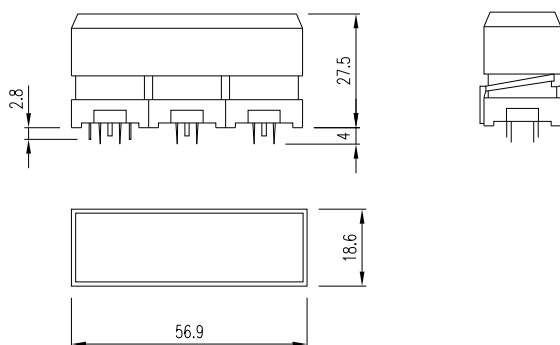

4 Keylock switch 2 positions page 39 | Keylock switch 3 positions page 39

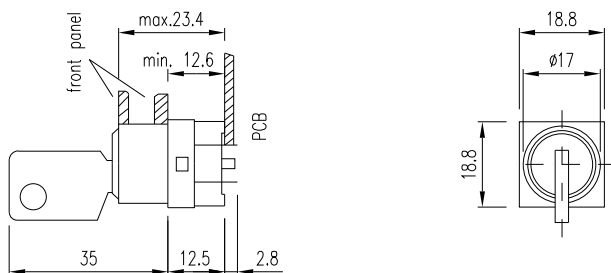

Circuit drawing

1 Indicator actuator single page 35



2 Illuminated pushbutton actuator single page 37

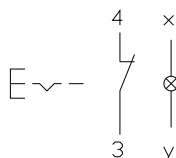

3 Illuminated pushbutton actuator single page 37

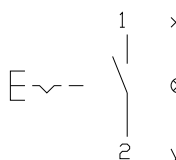

4 Illuminated pushbutton actuator single page 37

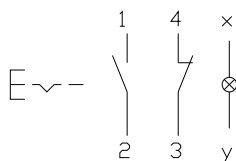

5 Illuminated pushbutton actuator double page 38

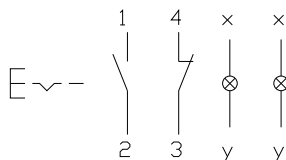

6 Illuminated pushbutton actuator triple page 38

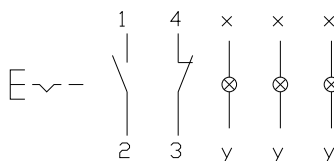

7 Illuminated pushbutton actuator single page 37

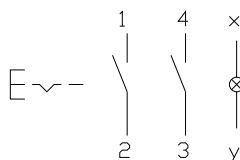

8 Illuminated pushbutton actuator double page 38

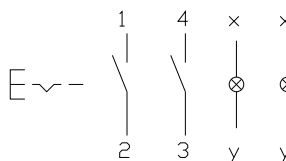

9 Illuminated pushbutton actuator triple page 38

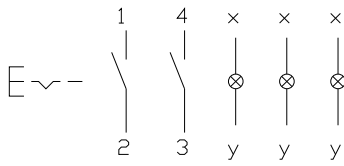

10 Illuminated pushbutton actuator single page 37

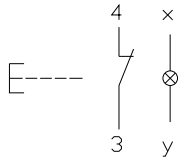

11 Illuminated pushbutton actuator single page 37

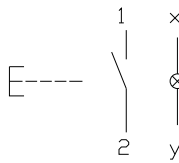

12 Illuminated pushbutton actuator single page 37

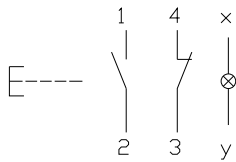

13 Illuminated pushbutton actuator double page 38

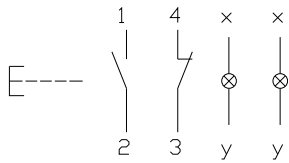

14 Illuminated pushbutton actuator triple page 38

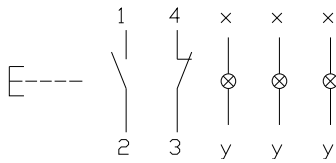

15 Illuminated pushbutton actuator single page 37

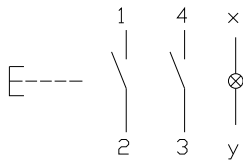

16 Illuminated pushbutton actuator double page 38

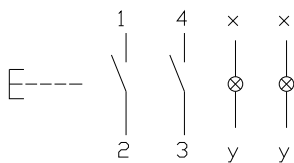

17 Illuminated pushbutton actuator triple page 38

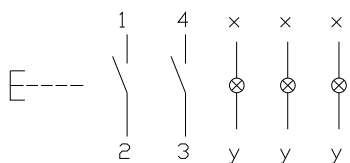

18 Keylock switch 2 positions page 39

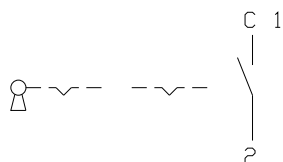

19 Keylock switch 3 positions page 39



20 Keylock switch 2 positions page 39

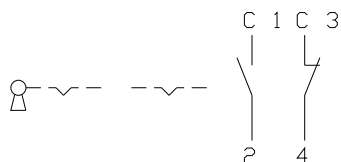

21 Keylock switch 2 positions page 39

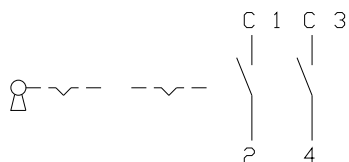

22 Indicator actuator double page 35

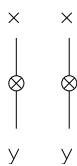

23 Indicator actuator triple page 36

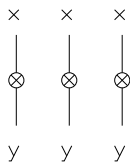

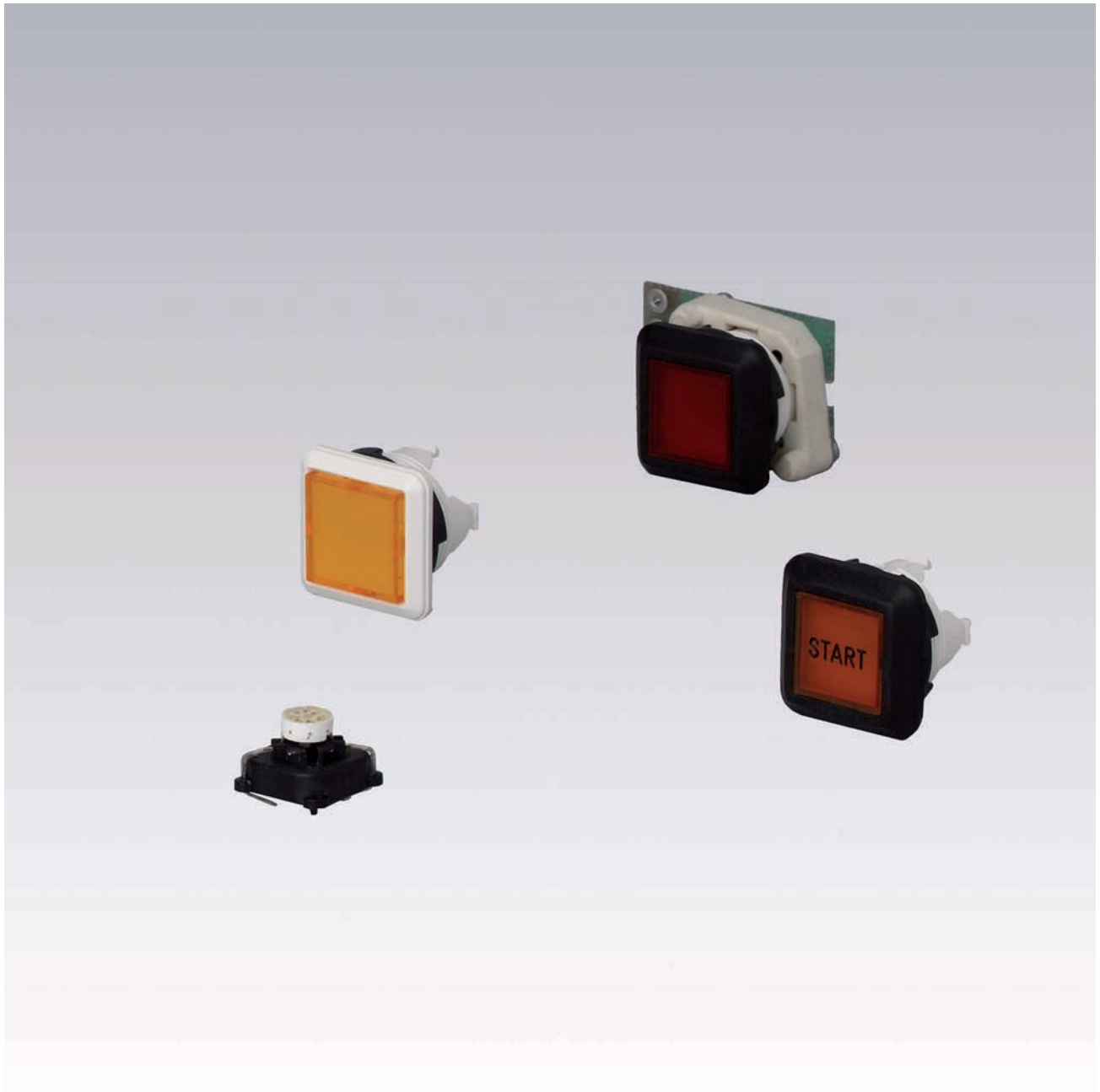

| | |
|-----------------------------|-----|
| Description | 55 |
| Product Assembly | 56 |
| Mounting instruction | 57 |
| PCB Pushbuttons | 58 |
| Accessories..... | 61 |
| Spare Parts | 64 |
| Technical Data..... | 66 |
| Application guidelines..... | 67 |
| Marking | 68 |
| Drawings..... | 69 |
| Index..... | 159 |

Product Information

General notes

With the series 92, users have a comprehensive range of applications at their disposal in the PCB key range. In particular, this series is an interesting alternative to the membrane switching system, because it offers convincing advantages, such as: Saving on initial costs, short manufacturing times, all-over illumination and a reliable and nevertheless removable PCB fastening technology.

With the series 92, many different applications are possible even as a discrete switch.

Thanks to front sealing IP 67, and the use of chemical-resistant materials, the elements of this series are suited for industrial use.

The actuator, measuring 18.8 x 18.8 mm at the front (18.8 x 18.4 mm IP 40), is available as an indicator, pushbutton or illuminated pushbutton in marked or unmarked versions.

In order to have matching colours, the actuator element can be supplied with different colours. The switching element complies with international protection level IP 40 and is solder-proof on the connection side. The specially formed connection legs prevent it from falling out when using flow soldering.

Mounting

The actuators of the series 92 are made for the standard 16 mm dia. mounting hole and fastened tightly to the front panel by means of a fixing nut. Mounting torque max. 50 Ncm.

The switching element is mounted on the printed board independently of the actuator. The arrangement of contacts is based on the matrix dimension 2.54 mm (1/10"). By means of the mounting flange, the PCB can be snapped on the pre-assembled actuator. Later adjustment is no longer necessary. The mounting flange is fastened to the PCB with two 1.8 mm dia. screws, also independent of the actuator. The positioning and the number of flanges is determined by the size of the front panel or PCB.

The actuators are protected against distortion.

Lenses

The flat front bezel with integrated pressure plate, made of UV resistant TPE has a black finish (standard). Colour variations enable the manufacture of transparent pressure plates of different colours.

Marking

For further information about hot stamping, laser marking and film inserts see part Marking.

Illumination

Perfect illumination of the touch surfaces available in various colours is assured by the LEDs Bi-Pin T1 in the colours blue, yellow, green, orange, red and white.

Luminosity and wave length scattering caused by the technology used in the LED manufacturing processes may lead to visual differences in our products.

Cleaning of soldered PCB

PCBs are often cleaned after machine soldering. When doing this, care must be taken to prevent the "cleaning fluid" polluted with dirt, grease and flux from penetrating the switch.

Specimen order

Illuminated pushbutton :

- Illuminated pushbutton actuator, IP 40, fronting black, lens yellow 92-458.400

Essential accessories :

- Switching element illuminative 92-851.342
- Single-LED T1 Bi-Pin, yellow 10-2602.3174D
- Mounting flange 92-960.0

*We reserve the right to modify technical data
All dimensions in mm*

Pushbutton illuminative, IP 40

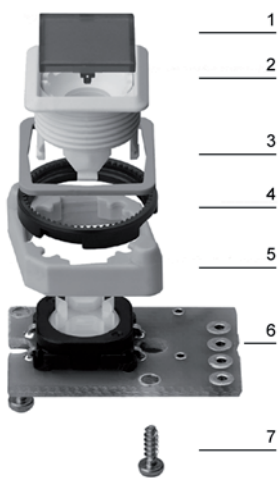

- 1 Lens
- 2 Actuator housing
- 3 Bezel
- 4 Fixing nut
- 5 Mounting flange
- 6 Switching element
- 7 Fixing screws

Pushbutton illuminative, IP 67

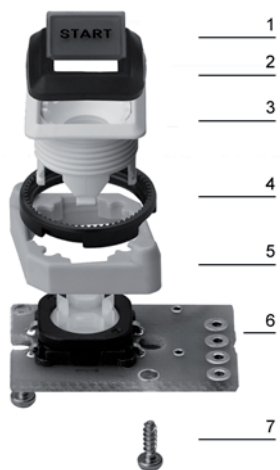

- 1 Lens
- 2 Front bezel
- 3 Actuator housing
- 4 Fixing nut
- 5 Mounting flange
- 6 Switching element
- 7 Fixing screws

Arrangement mounting flange

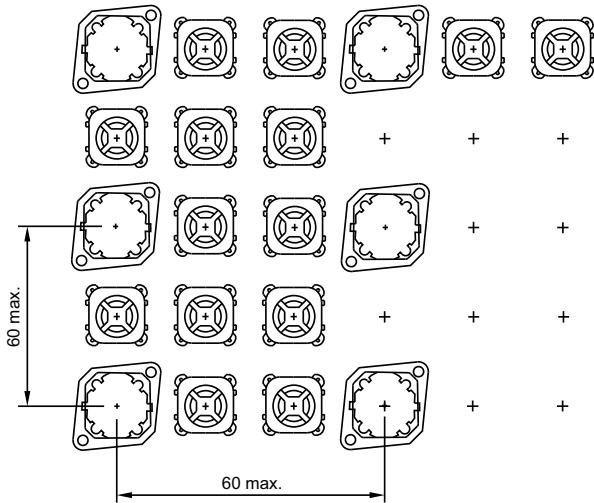

The arrangement of the mounting flanges and their number is determined by the size of the front panel or PCB. To ensure uniform, tactile switching, we recommend a layout of the flanges as per adjacent sketch.

For large PCBs with several switching elements we recommend the following procedure :

1. Fit the actuator to the front panel.
2. Clip the mounting flange to the rear of the intended actuator.
3. Screw the PCB with the components soldered to it to the assembled mounting flange.

This arrangement applies to PCBs 1.6 mm thick.

Dismantling mounting flange

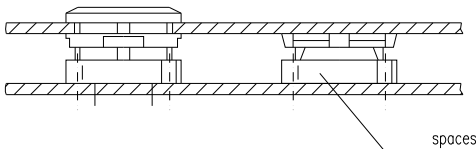

The tool 92-971.0 must be used for removing the mounting flange from the actuator. Before removing the flange, the PCB fixing screws must be loosened.

If the number of actuators is insufficient, use the spacer 92-965.0 which can be attached to the front panel.

The spacer can be adjusted to the following front panel thicknesses: 1.5/2/2.2/3/3.5/4 mm and can be stuck to the back of the panel free of dirt and grease.

Indicator actuator



Essential Accessories:

- Illumination element PCB mounting page 61
- Mounting flange page 63
- Single-LED page 62



| Indicator actuator | Front protection | Front bezel | Lens | Ø 18.8 x 18.8 mm Typ-Nr. | Ø 18.4 x 18.4 mm Typ-Nr. | Mounting dimensions | | Technical drawing |
|--------------------|------------------|----------------------------|--------------------------------|-----------------------------|-----------------------------|---------------------|-------|-------------------|
| | | | | | | | | |
| Indicator actuator | IP 67 | Plastic black | Plastic blue transparent | 92-143.600 | | 1 | 3 | 0.003 |
| | | | Plastic colourless transparent | 92-143.700 | | 1 | 3 | 0.003 |
| | | | Plastic green transparent | 92-143.500 | | 1 | 3 | 0.003 |
| | | | Plastic orange transparent | 92-143.300 | | 1 | 3 | 0.003 |
| | | | Plastic red transparent | 92-143.200 | | 1 | 3 | 0.003 |
| | | | Plastic yellow transparent | 92-143.400 | | 1 | 3 | 0.003 |
| | | Plastic white | Plastic blue transparent | 92-043.600 | | 1 | 3 | 0.003 |
| | | | Plastic colourless transparent | 92-043.700 | | 1 | 3 | 0.003 |
| | | | Plastic green transparent | 92-043.500 | | 1 | 3 | 0.003 |
| | | | Plastic orange transparent | 92-043.300 | | 1 | 3 | 0.003 |
| | | | Plastic red transparent | 92-043.200 | | 1 | 3 | 0.003 |
| | | | Plastic yellow transparent | 92-043.400 | | 1 | 3 | 0.003 |
| | IP 40 | Plastic black | Plastic blue transparent | | 92-158.600 | 1 | 4 | 0.003 |
| | | | Plastic colourless transparent | | 92-158.700 | 1 | 4 | 0.003 |
| | | | Plastic green transparent | | 92-158.500 | 1 | 4 | 0.003 |
| | | | Plastic orange transparent | | 92-158.300 | 1 | 4 | 0.003 |
| | | | Plastic red transparent | | 92-158.200 | 1 | 4 | 0.003 |
| | | | Plastic smoked transparent | | 92-158.100 | 1 | 4 | 0.003 |
| | | Plastic white | Plastic blue transparent | | 92-058.600 | 1 | 4 | 0.003 |
| | | | Plastic colourless transparent | | 92-058.700 | 1 | 4 | 0.003 |
| | | | Plastic green transparent | | 92-058.500 | 1 | 4 | 0.003 |
| | | | Plastic orange transparent | | 92-058.300 | 1 | 4 | 0.003 |
| | | | Plastic red transparent | | 92-058.200 | 1 | 4 | 0.003 |
| | | | Plastic smoked transparent | | 92-058.100 | 1 | 4 | 0.003 |
| | | Plastic yellow transparent | | 92-058.400 | 1 | 4 | 0.003 | |

Mounting dimensions from page 70, Technical drawing from page 70

Pushbutton actuator



Essential Accessories:

-  Mounting flange page 63
-  Switching element PCB mounting illuminative page 61



| | Front protection | Front bezel | Lens | Ø 18.8 x 18.8 mm Typ-Nr. | Ø 18.4 x 18.4 mm Typ-Nr. | Mounting dimensions | | | |
|----------------------------|------------------|---------------|----------------------|-----------------------------|-----------------------------|---------------------|-------------------|-----------------|---|
| | | | | | | Mounting dimensions | Technical drawing | Circuit drawing |  |
| Pushbutton actuator | IP 67 | Plastic black | Plastic black opaque | 92-441.000 | | 1 | 3 | 1 | 0.002 |
| | | | Plastic grey opaque | 92-441.800 | | 1 | 3 | 1 | 0.002 |
| | | Plastic white | Plastic black opaque | 92-341.000 | | 1 | 3 | 1 | 0.002 |
| | | | Plastic grey opaque | 92-341.800 | | 1 | 3 | 1 | 0.002 |
| | IP 40 | Plastic black | Plastic black opaque | | 92-456.000 | 1 | 4 | 1 | 0.002 |
| | | | Plastic grey opaque | | 92-456.800 | 1 | 4 | 1 | 0.002 |
| | | | Plastic white opaque | | 92-456.900 | 1 | 4 | 1 | 0.002 |
| | | Plastic white | Plastic black opaque | | 92-356.000 | 1 | 4 | 1 | 0.002 |
| | | | Plastic grey opaque | | 92-356.800 | 1 | 4 | 1 | 0.002 |
| | | | Plastic white opaque | | 92-356.900 | 1 | 4 | 1 | 0.002 |

Mounting dimensions from page 70, Technical drawing from page 70, Circuit drawing from page 71

Illuminated pushbutton actuator



Essential Accessories:

-  Mounting flange page 63
-  Single-LED page 62
-  Switching element PCB mounting illuminative page 61

| | Front protection | Front bezel | Lens | Ø 18.8 x 18.8 mm Typ-Nr. | Ø 18.4 x 18.4 mm Typ-Nr. | Mounting dimensions | Technical drawing | Circuit drawing |  | | |
|--|----------------------------|----------------------------|--------------------------------|--------------------------------|-----------------------------|---------------------|-------------------|-----------------|---|-------|-------|
| | | | | | | | | | | | |
| Illuminated pushbutton actuator | IP 67 | Plastic black | Plastic blue transparent | 92-443.600 | | 1 | 3 | 1 | 0.003 | | |
| | | | Plastic colourless transparent | 92-443.700 | | 1 | 3 | 1 | 0.003 | | |
| | | | Plastic green transparent | 92-443.500 | | 1 | 3 | 1 | 0.003 | | |
| | | | Plastic orange transparent | 92-443.300 | | 1 | 3 | 1 | 0.003 | | |
| | | | Plastic red transparent | 92-443.200 | | 1 | 3 | 1 | 0.003 | | |
| | | | Plastic yellow transparent | 92-443.400 | | 1 | 3 | 1 | 0.003 | | |
| | | Plastic white | Plastic blue transparent | 92-343.600 | | 1 | 3 | 1 | 0.003 | | |
| | | | Plastic colourless transparent | 92-343.700 | | 1 | 3 | 1 | 0.003 | | |
| | | | Plastic green transparent | 92-343.500 | | 1 | 3 | 1 | 0.003 | | |
| | | | Plastic orange transparent | 92-343.300 | | 1 | 3 | 1 | 0.003 | | |
| | | | Plastic red transparent | 92-343.200 | | 1 | 3 | 1 | 0.003 | | |
| | | | Plastic yellow transparent | 92-343.400 | | 1 | 3 | 1 | 0.003 | | |
| | | IP 40 | Plastic black | Plastic blue transparent | | 92-458.600 | | 1 | 4 | 1 | 0.003 |
| | | | | Plastic colourless transparent | | 92-458.700 | | 1 | 4 | 1 | 0.003 |
| | Plastic green transparent | | | | 92-458.500 | | 1 | 4 | 1 | 0.003 | |
| | Plastic orange transparent | | | | 92-458.300 | | 1 | 4 | 1 | 0.003 | |
| | Plastic red transparent | | | | 92-458.200 | | 1 | 4 | 1 | 0.003 | |
| | Plastic smoked transparent | | | | 92-458.100 | | 1 | 4 | 1 | 0.003 | |
| | Plastic yellow transparent | | | | 92-458.400 | | 1 | 4 | 1 | 0.003 | |
| | Plastic white | | Plastic blue transparent | | 92-358.600 | | 1 | 4 | 1 | 0.003 | |
| Plastic colourless transparent | | | | 92-358.700 | | 1 | 4 | 1 | 0.003 | | |
| Plastic green transparent | | | | 92-358.500 | | 1 | 4 | 1 | 0.003 | | |
| | | Plastic orange transparent | | 92-358.300 | | 1 | 4 | 1 | 0.003 | | |
| | | Plastic red transparent | | 92-358.200 | | 1 | 4 | 1 | 0.003 | | |
| | | Plastic smoked transparent | | 92-358.100 | | 1 | 4 | 1 | 0.003 | | |
| | | Plastic yellow transparent | | 92-358.400 | | 1 | 4 | 1 | 0.003 | | |

Mounting dimensions from page 70, Technical drawing from page 70, Circuit drawing from page 71

Front

Blind plug

| | | Typ-Nr. | Mounting dimensions |  |
|-------------------|---------------|-----------------|---------------------|---|
| | Blind plug | ∅ 18 x 18 mm | | |
| Blind plug | Plastic black | 51-948.0 | 1 | 0.003 |



Mounting dimensions from page 70

Backside

Illumination element PCB mounting

The customer has to decide what series resistor shall be used to the LED

| | Terminals | Typ-Nr. | Component layout | Technical drawing |  |
|--|-----------|-------------------|------------------|-------------------|---|
| Illumination element PCB mounting | P | 92-800.042 | 1 | 1 | 0.001 |



Illumination and mounting flange to be ordered separately.

Terminals: P = PCB terminal

Component layout from page 69, Technical drawing from page 70

Switching element PCB mounting illuminative

The customer has to decide what series resistor shall be used to the LED

| | Terminals | Typ-Nr. | Component layout | Technical drawing | Circuit drawing |  |
|--|-----------|-------------------|------------------|-------------------|-----------------|---|
| Switching element PCB mounting illuminative | P | 92-851.342 | 2 | 5 | 2 | 0.001 |



Illumination and mounting flange to be ordered separately.

Terminals: P = PCB terminal

Component layout from page 69, Technical drawing from page 70, Circuit drawing from page 71

Spacer

| | Typ-Nr. |  |
|---------------|-----------------|---|
| Spacer | 92-965.0 | 0.003 |



When fitting, ensure that back of panel is free of grease and dirt

PCB assembled

| | Typ-Nr. |  |
|--|-----------------|---|
| PCB assembled for discrete switching applications including switching element and mounting flange, soldering terminal (assembled PCB incl. series resistor and LED on request) | 92-981.0 | 0.003 |



Illumination

Single-LED

The customer has to decide what series resistor shall be used to the LED

| | Socket | Operating voltage/-current | Light colour | Typ-Nr. |  |
|-------------------|-----------|----------------------------|--------------|----------------------|---|
| Single-LED | T1 Bi-Pin | 2.1 VDC, 20 mA | orange | 10-2602.3203L | 0.001 |
| | | | red | 10-2602.3202L | 0.001 |
| | | 2.2 VDC, 20 mA | yellow | 10-2602.3174D | 0.001 |
| | | | blue | 10-2602.3206L | 0.001 |
| | | | green | 10-2602.3205L | 0.001 |
| | | | white | 10-2602.3209L | 0.001 |



Bi-colour LED

The customer has to decide what series resistor shall be used to the LED

| | Socket | Light colour | Operating voltage/-current | Typ-Nr. |  |
|----------------------|-----------|--------------|----------------------------|----------------------|---|
| Bi-colour LED | T1 Bi-Pin | red/green | 1.9/3.5 VDC, 20 mA | 10-2603.320AL | 0.001 |
| | | yellow/green | 2.0/3.2 VDC, 20 mA | 10-2603.320CL | 0.001 |



Multi-LED

The customer has to decide what series resistor shall be used to the LED

| | Socket | Operating voltage/-current | Light colour | Typ-Nr. |  |
|------------------|-----------|----------------------------|--------------|----------------------|---|
| Multi-LED | T1 Bi-Pin | 12 VDC, 40 mA | yellow | 10-5609.3174D | 0.001 |



Assembling

Anti-twist ring

for front panel thickness max. 2 mm

| | Typ-Nr. |  |
|---|---------------|---|
| Anti-twist ring Mounting hole size 16 mm dia. | 51-910 | 0.001 |



Mounting flange



| | Typ-Nr. | Technical drawing | kg |
|------------------------|-----------------|-------------------|-------|
| Mounting flange | 92-960.0 | 2 | 0.001 |

Technical drawing from page 70

Lens remover



| | Typ-Nr. | kg |
|--|---------------|-------|
| Lens remover for lens plate IP 40 only | 18-910 | 0.002 |

Mounting tool



| | Typ-Nr. | kg |
|--|---------------|-------|
| Mounting tool for Indicator 16 mm dia. | 01-907 | 0.020 |

Dismantling tool



| | Typ-Nr. | kg |
|--|-----------------|-------|
| Dismantling tool for actuator dismantling of switching- and illumination element and mounting flange | 92-971.0 | 0.002 |

Pushbutton- and Illuminated pushbutton actuator IP 40

Pushbutton- and Illuminated pushbutton actuator IP 40

Lens and Front bezel order separately

| | Front ring | ∅ 18.4 x 18.4 mm Typ-Nr. |  |
|--|---------------|-----------------------------|---|
| Pushbutton- and Illuminated pushbutton actuator IP 40 | Plastic black | 92-450.000 | 0.003 |
| | Plastic white | 92-350.000 | 0.003 |



Lens for pushbuttons and indicators IP 40

| | Lens | ∅ 18.4 x 18.4 mm Typ-Nr. |  |
|---|--------------------------------|-----------------------------|---|
| Lens for pushbuttons and indicators IP 40 13.2 x 13.2 mm with white Marking plate | Plastic black opaque | 92-956.000 | 0.001 |
| | Plastic blue translucent | 92-956.600 | 0.001 |
| | Plastic blue transparent | 92-958.600 | 0.001 |
| | Plastic colourless transparent | 92-958.700 | 0.001 |
| | Plastic green translucent | 92-956.500 | 0.001 |
| | Plastic green transparent | 92-958.500 | 0.001 |
| | Plastic grey opaque | 92-956.800 | 0.001 |
| | Plastic orange translucent | 92-956.300 | 0.001 |
| | Plastic orange transparent | 92-958.300 | 0.001 |
| | Plastic red translucent | 92-956.200 | 0.001 |
| | Plastic red transparent | 92-958.200 | 0.001 |
| | Plastic smoked transparent | 92-958.100 | 0.001 |
| | Plastic white opaque | 92-956.900 | 0.001 |
| | Plastic yellow translucent | 92-956.400 | 0.001 |
| Plastic yellow transparent | 92-958.400 | 0.001 | |



Front bezel for pushbuttons and indicators IP 40

| | Front ring | ∅ 18.4 x 18.4 mm Typ-Nr. |  |
|---|---------------|-----------------------------|---|
| Front bezel for pushbuttons and indicators IP 40 | Plastic black | 92-912.0 | 0.001 |
| | Plastic white | 92-912.9 | 0.001 |



Pushbutton- and Illuminated pushbutton actuator IP 67

Pushbutton- and Illuminated pushbutton actuator IP 67

Lens order separately

| | Front ring | ∅ 18.8 x 18.8 mm Typ-Nr. |  |
|--|---------------|-----------------------------|---|
| Pushbutton- and Illuminated pushbutton actuator IP 67 | Plastic black | 92-440.000 | 0.003 |
| | | 92-340.000 | 0.003 |



Indicator actuator IP 67

Lens plate order separately

| | Front ring | ∅ 18.8 x 18.8 mm Typ-Nr. |  |
|---------------------------------|---------------|-----------------------------|---|
| Indicator actuator IP 67 | Plastic black | 92-140.000 | 0.003 |



Lens for pushbuttons and indicators IP 67

| | Lens plate | ∅ 18.8 x 18.8 mm Typ-Nr. |  |
|--|--------------------------------------|-----------------------------|---|
| Lens for pushbuttons and indicators IP 67 12 x 12 mm | Plastic black flush opaque | 92-941.000 | 0.001 |
| | Plastic blue flush transparent | 92-941.600 | 0.001 |
| | Plastic colourless flush transparent | 92-941.700 | 0.001 |
| | Plastic green flush transparent | 92-941.500 | 0.001 |
| | Plastic grey flush opaque | 92-941.800 | 0.001 |
| | Plastic orange flush transparent | 92-941.300 | 0.001 |
| | Plastic red flush transparent | 92-941.200 | 0.001 |
| | Plastic yellow flush transparent | 92-941.400 | 0.001 |



Pushbutton- and Illuminated pushbutton

Switching system

Short-travel switching system with 2 independent contact points and tactile operation.
Guarantees reliable switching even of very light loads.
Fitted with 1 normally open contact.

Material

Lens

Polycarbonate (PC)

Front bezel

Thermoplastic Elastomer (TPE)

Frame

Thermoplastic Polyester (PBT)

Material of contact

Gold (Au)

Switching element

Thermoplastic Polyester (PET, PBT) and Polyacetale (POM)

Actuator housing

Thermoplastic Polyester (PBT)

Mechanical characteristics

Tightening torque

Fixing screw 40 Ncm recommended
Fixing nut max. 50 Ncm

Actuating force

2.7 N \pm 1 N measured at the switching element
5 N measured at the lens

Actuating travel

Switching element 0.4 mm

Rebound time

\leq 1 ms

Resistance to heat of soldering

260 °C, 5 s, as per IEC 60068-2-20

Mechanical lifetime

\geq 1 Million operations as per IEC 60512-5-9a

Electrical characteristics

Contact resistance

Starting value (initial) \leq 100 m Ω as per IEC 60512-2-2b

Isolation resistance

\geq 10⁹ Ω between all terminals at 100 VDC, as per IEC 60512-2-3a

Electrical life

\geq 500 000 operations at 42 VDC, 50 mA as per IEC 60512-5-9c.
When attention is paid to the direction of current flow from terminal 3/4 to 1/2 the electrical life can be prolonged.

Electrostatic discharge (ESD)

15 kV

Switch rating

| | |
|-------------------|--|
| Switching voltage | min. 50 mV AC/DC max. 42 V AC/DC |
| Switching current | min. 10 μ A AC/DC max. 100 mA AC/DC |
| Power rating | max. 2 W |

Electric strength

500 VAC, 50 Hz, 1 min, as per IEC 60512-2-4a

Environmental conditions

Storage temperature

-40 °C ... +80 °C

Operating temperature

-25 °C ... +70 °C

Front protection

Switching element IP 40 (fluxproof to DIN 41640 Part 84)
front IP 67 or IP 40

Shock resistance

\leq 50 g for 11 ms as per IEC 60512-4-6c

Vibration resistance

(sinusoidal)

10 g at 10-2000 Hz, amplitude 0.75 mm as per IEC 60512-4-6d

Suppressor circuits

When switching inductive loads such as relays, DC motors, and DC solenoids, it is always important to absorb surges (e.g. with a diode) to protect the contacts. When these inductive loads are switched off, a counter emf can severely damage switch contacts and greatly shorten lifetime.

Fig. 1 shows an inductive load with a free-wheeling diode connected in parallel. This free-wheeling diode provides a path for the inductor current to flow when the current is interrupted by the switch. Without this free-wheeling diode, the voltage across the coil will be limited only by dielectric break-down voltages of the circuit or parasitic elements of the coil. This voltage can be kilovolts in amplitude even when nominal circuit voltages are low (e.g. 12 VDC) see Fig. 2.

The free-wheeling diode should be chosen so that the reverse breakdown voltage is greater than the voltage driving the inductive load. The DC blocking voltage (VR) of the free-wheeling diode can be found in the datasheet of a diode. The forward current should be equal or greater than the maximum current flowing through the load.

To get an efficient protection, the free-wheeling diode must be connected as close as possible to the inductive load!

Switching with inductive load
Fig. 1

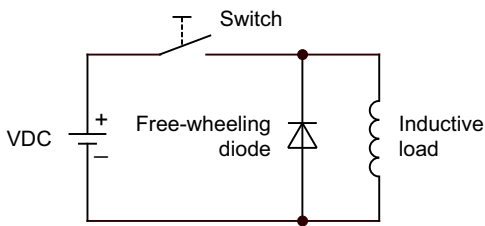

Counter emf
over load without free-wheeling diode
Fig. 2

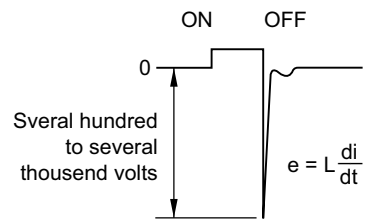

General notes

If desired, the actuators of the series 92 can be supplied ready marked. With your order please enclose a list of the desired markings or a drawing, showing the type or size of script or the symbols desired.

1. Laser engraving (Fig. 1)

In addition to the most commonly used world languages, in DIN 1451-3 close spacing, other typefaces are available as Scandinavian, Slavic, Greek, Russian and Polish. Red, blue and black lenses are filled with white colour. Other colour lenses are filled in black. Standard height of letters is 2 mm. If the height is not specified, we will supply 2 mm engraved letters.

2. Hot stamping (Fig. 1)

For larger series it is worth considering markings by means of hot stamping. We will be pleased to advise you. For letters and figures, typefaces with 2.5 mm, 3 mm and 4 mm are available.

3. Film inserts (Fig. 2)

Instead of using engraving, the actuator can be fitted with transparent film inserts. However, for this purpose the use of transparent lens caps is recommended. If smoked lens caps are used the lettering does not become visible until the LED is alight. Max. size of film insert
11.4 x 11.4 mm for IP 40
10.4 x 10.4 mm for IP 67
Film thickness 0.2 mm.

All dimensions in mm

| Height of letters h | Number of lines | Number of (target value) capital letters per line | Number of (target value) small letters per line |
|------------------------|-----------------|--|--|
| 3 | 2 | 5 - 6 | 6 |
| 4 | 2 | 4 | 4 |
| 5 | 1 | 3 | 3 - 4 |
| 6 | 1 | 2 - 3 | 3 |
| 8 | 1 | 2 | 2 |

Fig. 1

Fig. 2

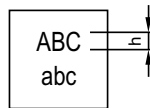
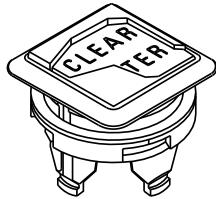
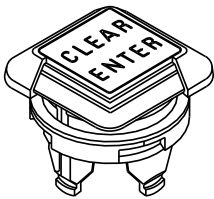

Component layout

1 Illumination element PCB mounting page 61

Single-LED

Drilling plan (Elementside)

- A Fixing holes for mounting flange (92-960.0)
- B Holes for LED
- C Holes for centering pins

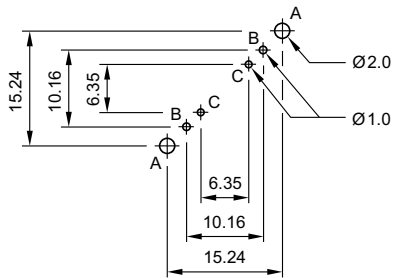

Bi-colour-LED

Drilling plan (Elementside)

- A Fixing holes for mounting flange (92-960.0)
- B Holes for Bi-colour LED:
 - BA1 (green) + BA2 (yellow or red) = Anodes, BC = Cathode
- C Holes for centering pins

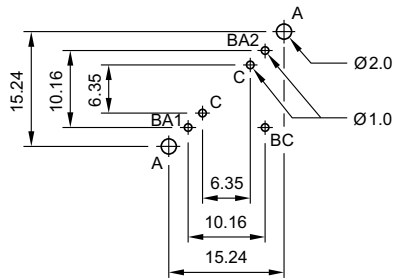

Libraries for the PCB layout-system p-cad 200X see : www.pcad.com/en/library Third-party Libraries

2 Switching element PCB mounting illuminative page 61

Single-LED

Drilling plan (Elementside)

- A Fixing holes for mounting flange (92-960.0)
- B Holes for LED
- C Holes for contact pins
 - Pad max. Ø 2.5 mm
 - Through-connection recommended

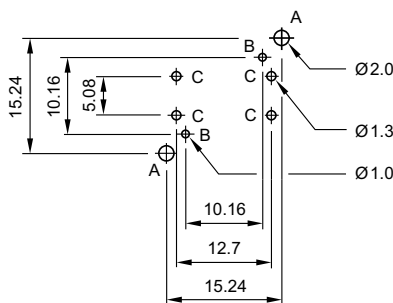

Bi-colour-LED

Drilling plan (Elementside)

- A Fixing holes for mounting flange (92-960.0)
- B Holes for Bi-colour LED:
 - BA1 (green) + BA2 (yellow or red) = Anodes, BK = Cathode
- C Holes for contact pins
 - Pad max. Ø 2.5 mm
 - Through-connection recommended

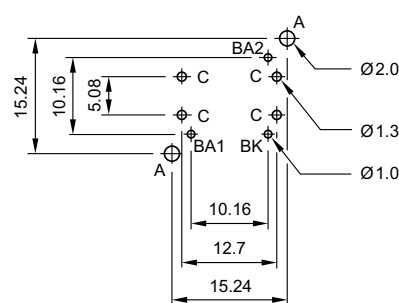

Libraries for the PCB layout-system p-cad 200X see : www.pcad.com/en/library Third-party Libraries

Mounting dimensions

1 Indicator actuator page 58 | Pushbutton actuator page 59 | Illuminated pushbutton actuator page 60 | Blind plug page 61

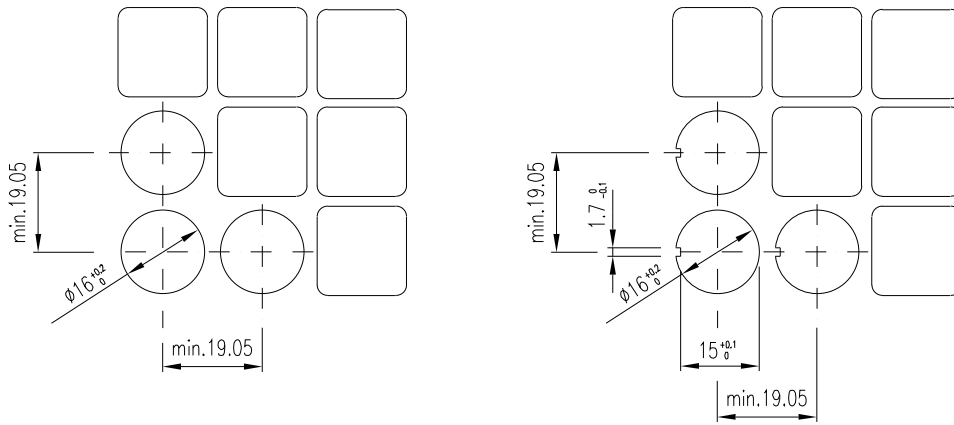

Technical drawing

1 Illumination element PCB mounting page 61

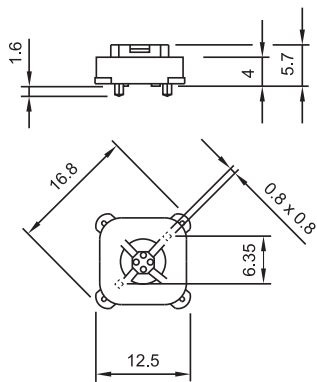

2 Mounting flange page 63

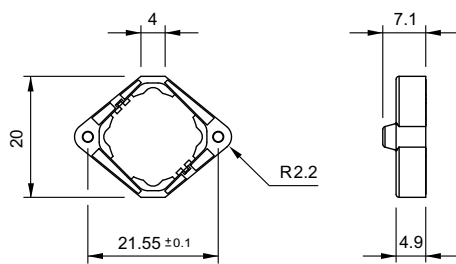

3 Indicator actuator page 58 | Pushbutton actuator page 59 | Illuminated pushbutton actuator page 60

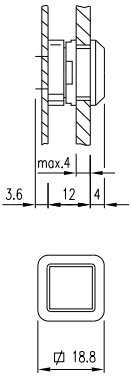

4 Indicator actuator page 58 | Pushbutton actuator page 59 | Illuminated pushbutton actuator page 60

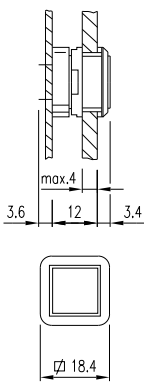

5 Switching element PCB mounting illuminative page 61

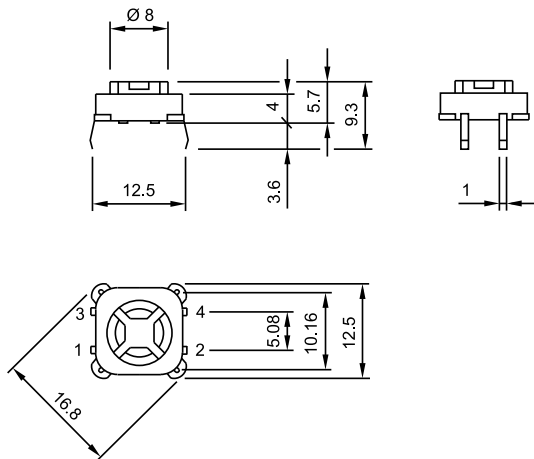

Circuit drawing

1 Pushbutton actuator page 59 | Illuminated pushbutton actuator page 60



2 Switching element PCB mounting illuminative page 61

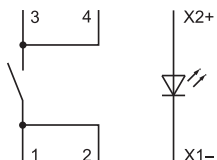

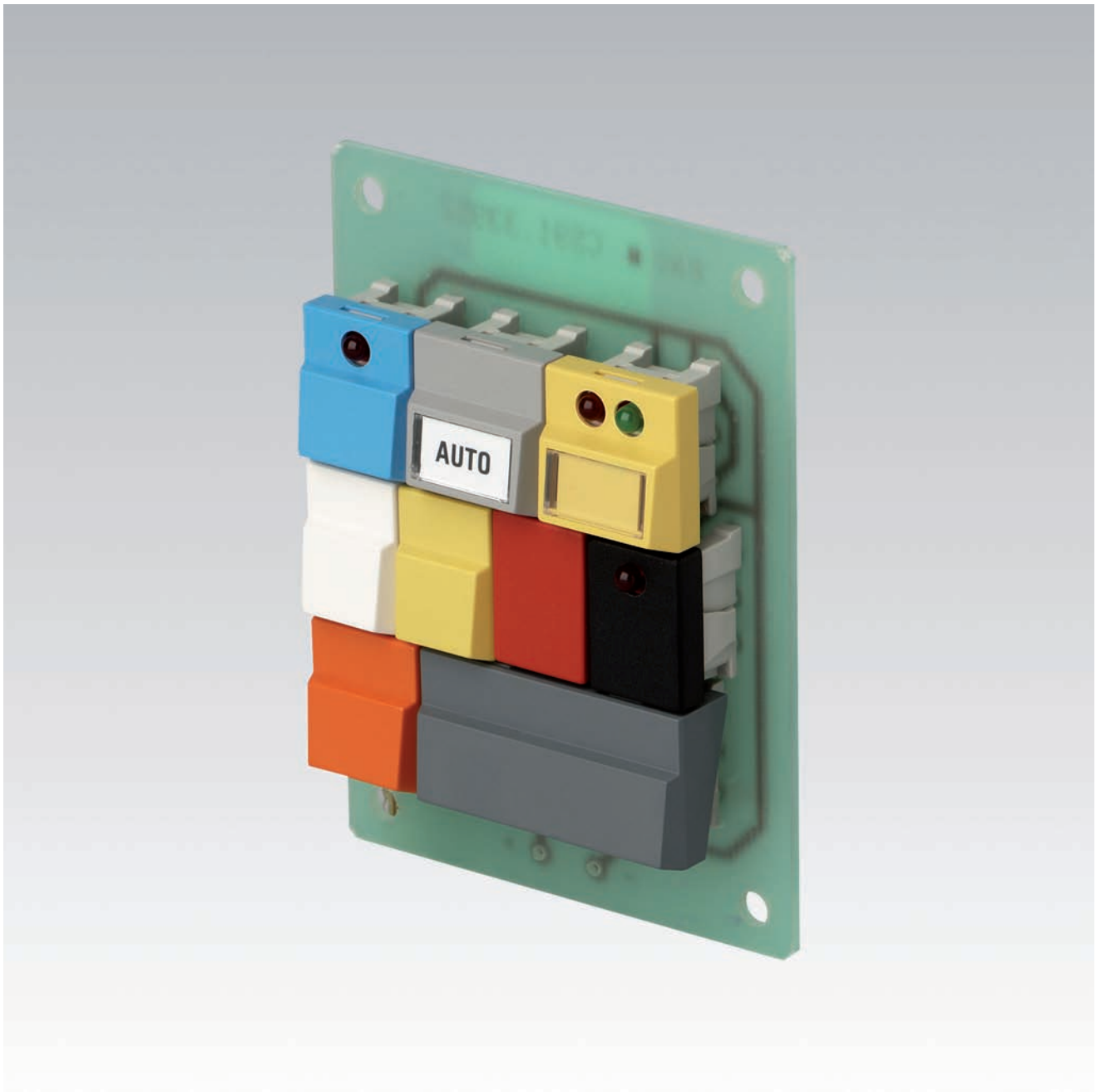

| | |
|-------------------------------|------------|
| Description | 75 |
| Product Assembly | 76 |
| PCB Pushbuttons | 77 |
| Accessories | 78 |
| Technical Data..... | 85 |
| Marking | 86 |
| Drawings..... | 87 |
| Index..... | 159 |

Product Information

General notes

The input button of series 96 is a component specially designed for the requirements of modern electronic control systems. Since there is a choice of different lens shapes and colours, the panel can be arranged to suit the needs of the particular application.

Mounting

The input button is intended for mounting on printed circuit boards. Its dimensions and the arrangement of its contacts comply with a module of 2.54 mm (1/10 "). Two centering pins ensure that rows or blocks are assembled without gaps, true to drawing. The input button is dust and sprayproof and suitable for machine soldering and cleaning.

Lenses

Lenses can be pressed singly on to the input button. Depending on requirements, the user can employ lenses having either a momentary or maintained action, with various standard widths and colours.

Marking

For further information about engraving, hot stamping and film inserts see part Marking.

Illumination

For illumination, indication or functional check the input button can be equipped with one or two light-emitting diodes (LED) 3 mm dia. For illumination some lenses are provided with recesses for LEDs. Luminosity and wave length scattering caused by the technology used in the LED manufacturing processes may lead to visual differences in our products.

Specimen order

Indicator :

- Indicator element 96-302.807

Essential accessories :

- Cap for Indicator, Plastic grey, 1 LED, 12.4 x 17.4 mm 96-909.8

- Single-LED T1 Bi-Pin, 2.2 VDC, 20 mA, yellow 10-2602.3174E

*We reserve the right to modify technical data
All dimensions in mm*

Illuminated pushbutton





- 1 Lens
- 2 Switching element

Indicator

for Indicator and Blind plug
 usable for Caps 17.4 x 17.4 mm | 12.4 x 17.4 mm | 14.8 x 17.4 mm



Essential Accessories:

-  Cap for Indicator page 78
-  Single LED standard page 84

| | Front protection | Terminals | Typ-Nr. | Component layout | Technical drawing | |
|------------------|------------------|-----------|-------------------|------------------|-------------------|---|
| Indicator | IP 67 | P | 96-302.807 | 1 | 2 | 0.001  |



Terminals: P = PCB terminal
 Component layout from page 87, Technical drawing from page 87

Illuminated pushbutton

Switching element usable for lenses 17.4 x 17.4 mm | 12.4 x 17.4 mm | 14.8 x 17.4 mm



Essential Accessories:

-  Lens standard single page 79
-  Single LED standard page 84

| | Front protection | Contacts | Terminals | Typ-Nr. | Component layout | Technical drawing | Circuit drawing | |
|-------------------------------|------------------|----------|-----------|-------------------|------------------|-------------------|-----------------|---|
| Illuminated pushbutton | IP 67 | 1 C | P | 96-323.837 | 2 | 3 | 1 | 0.002  |

Contacts: C = Changeover
 Terminals: P = PCB terminal
 Component layout from page 87, Technical drawing from page 87, Circuit drawing from page 89

Front

Cap for Indicator

| | Recess for LED | Cap | Colour | ∅ 17.4 x 17.4 mm | ∅ 14.8 x 17.4 mm | ∅ 12.4 x 17.4 mm | Technical drawing | kg/Pk |
|-------------------------------------|----------------|-------|----------|------------------|------------------|------------------|-------------------|-------|
| | | | | Typ-Nr. | Typ-Nr. | Typ-Nr. | | |
| Cap for Indicator Plastic | 1 | black | RAL 9011 | 96-939.0 | 96-929.0 | 96-909.0 | 2 | 0.001 |
| | | green | RAL 6005 | 96-939.5 | 96-929.5 | 96-909.5 | 2 | 0.001 |
| | | grey | RAL 7012 | 96-939.8 | 96-929.8 | 96-909.8 | 2 | 0.001 |
| | | red | RAL 3016 | 96-939.2 | 96-929.2 | 96-909.2 | 2 | 0.001 |
| | 2.2 | black | RAL 9011 | 96-940.0 | 96-930.0 | 96-910.0 | 2 | 0.001 |
| | | green | RAL 6005 | 96-940.5 | 96-930.5 | 96-910.5 | 2 | 0.001 |
| | | grey | RAL 7012 | 96-940.8 | 96-930.8 | 96-910.8 | 2 | 0.001 |
| | | red | RAL 3016 | 96-940.2 | 96-930.2 | 96-910.2 | 2 | 0.001 |



Technical drawing from page 87

Lens standard single

| | Switching action | Recess for LED | Lens | Colour | ∅ 17.4 x 17.4 mm | ∅ 14.8 x 17.4 mm | ∅ 12.4 x 17.4 mm | Technical drawing |  |
|--|------------------|-----------------|-----------------|-----------------|------------------|------------------|------------------|-------------------|---|
| | | | | | Typ-Nr. | Typ-Nr. | Typ-Nr. | | |
| Lens standard single Plastic | MA | 0 | black | RAL 9011 | 96-935.0 | 96-925.0 | 96-905.0 | 1 | 0.001 |
| | | | blue | - | 98-935.6 | 98-925.6 | 98-905.6 | 1 | 0.001 |
| | | | green | - | 98-935.5 | 98-925.5 | 98-905.5 | 1 | 0.001 |
| | | | | RAL 6005 | 96-935.5 | 96-925.5 | 96-905.5 | 1 | 0.001 |
| | | | grey | - | 98-935.8 | 98-925.8 | 98-905.8 | 1 | 0.001 |
| | | | | RAL 7012 | 96-935.8 | 96-925.8 | 96-905.8 | 1 | 0.001 |
| | | | orange | - | 98-935.3 | 98-925.3 | 98-905.3 | 1 | 0.001 |
| | | | red | - | 98-935.2 | 98-925.2 | 98-905.2 | 1 | 0.001 |
| | | | | RAL 3016 | 96-935.2 | 96-925.2 | 96-905.2 | 1 | 0.001 |
| | | white | - | 98-935.9 | 98-925.9 | 98-905.9 | 1 | 0.001 | |
| | | yellow | - | 98-935.4 | 98-925.4 | 98-905.4 | 1 | 0.001 | |
| | | 1 | black | RAL 9011 | 96-936.0 | 96-926.0 | 96-906.0 | 1 | 0.001 |
| | | | blue | - | 98-936.6 | 98-926.6 | 98-906.6 | 1 | 0.001 |
| | | | green | - | 98-936.5 | 98-926.5 | 98-906.5 | 1 | 0.001 |
| | | | | RAL 6005 | 96-936.5 | 96-926.5 | 96-906.5 | 1 | 0.001 |
| | | | grey | - | 98-936.8 | 98-926.8 | 98-906.8 | 1 | 0.001 |
| | | | | RAL 7012 | 96-936.8 | 96-926.8 | 96-906.8 | 1 | 0.001 |
| | | | orange | - | 98-936.3 | 98-926.3 | 98-906.3 | 1 | 0.001 |
| | | | red | - | 98-936.2 | 98-926.2 | 98-906.2 | 1 | 0.001 |
| | | | | RAL 3016 | 96-936.2 | 96-926.2 | 96-906.2 | 1 | 0.001 |
| | | white | - | 98-936.9 | 98-926.9 | 98-906.9 | 1 | 0.001 | |
| | | yellow | - | 98-936.4 | 98-926.4 | 98-906.4 | 1 | 0.001 | |
| | | 2 | black | RAL 9011 | 96-937.0 | 96-927.0 | 96-907.0 | 1 | 0.001 |
| | | | blue | - | 98-937.6 | 98-927.6 | 98-907.6 | 1 | 0.001 |
| | | | green | - | 98-937.5 | 98-927.5 | 98-907.5 | 1 | 0.001 |
| | | | | RAL 6005 | 96-937.5 | 96-927.5 | 96-907.5 | 1 | 0.001 |
| | | | grey | - | 98-937.8 | 98-927.8 | 98-907.8 | 1 | 0.001 |
| | | | | RAL 7012 | 96-937.8 | 96-927.8 | 96-907.8 | 1 | 0.001 |
| | | | orange | - | 98-937.3 | 98-927.3 | 98-907.3 | 1 | 0.001 |
| | | | red | - | 98-937.2 | 98-927.2 | 98-907.2 | 1 | 0.001 |
| RAL 3016 | 96-937.2 | | | 96-927.2 | 96-907.2 | 1 | 0.001 | | |
| white | - | 98-937.9 | 98-927.9 | 98-907.9 | 1 | 0.001 | | | |
| yellow | - | 98-937.4 | 98-927.4 | 98-907.4 | 1 | 0.001 | | | |



Continuation see I

Continued from previous page

| Lens | Switching action | Recess for LED | Lens | Colour | ∅ 17.4 x 17.4 mm | ∅ 14.8 x 17.4 mm | ∅ 12.4 x 17.4 mm | Technical drawing |  | | |
|---------------------------------------|------------------|-----------------|-----------------|-----------------|------------------|------------------|------------------|-------------------|---|-------|-------|
| | | | | | Typ-Nr. | Typ-Nr. | Typ-Nr. | | | | |
| Lens standard single Plastic | M | 0 | black | RAL 9011 | 96-931.0 | 96-921.0 | 96-901.0 | 1 | 0.001 | | |
| | | | blue | - | 98-931.6 | 98-921.6 | 98-901.6 | 1 | 0.001 | | |
| | | | green | - | 98-931.5 | 98-921.5 | 98-901.5 | 1 | 0.001 | | |
| | | | | RAL 6005 | 96-931.5 | 96-921.5 | 96-901.5 | 1 | 0.001 | | |
| | | | grey | - | 98-931.8 | 98-921.8 | 98-901.8 | 1 | 0.001 | | |
| | | | | RAL 7012 | 96-931.8 | 96-921.8 | 96-901.8 | 1 | 0.001 | | |
| | | | orange | - | 98-931.3 | 98-921.3 | 98-901.3 | 1 | 0.001 | | |
| | | | red | - | 98-931.2 | 98-921.2 | 98-901.2 | 1 | 0.001 | | |
| | | | | RAL 3016 | 96-931.2 | 96-921.2 | 96-901.2 | 1 | 0.001 | | |
| | | white | - | 98-931.9 | 98-921.9 | 98-901.9 | 1 | 0.001 | | | |
| | | yellow | - | 98-931.4 | 98-921.4 | 98-901.4 | 1 | 0.001 | | | |
| | | 1 | 1 | 1 | black | RAL 9011 | 96-932.0 | 96-922.0 | 96-902.0 | 1 | 0.001 |
| | | | | | blue | - | 98-932.6 | 98-922.6 | 98-902.6 | 1 | 0.001 |
| | | | | | green | - | 98-932.5 | 98-922.5 | 98-902.5 | 1 | 0.001 |
| | | | | | | RAL 6005 | 96-932.5 | 96-922.5 | 96-902.5 | 1 | 0.001 |
| | grey | | | | - | 98-932.8 | 98-922.8 | 98-902.8 | 1 | 0.001 | |
| | | | | | RAL 7012 | 96-932.8 | 96-922.8 | 96-902.8 | 1 | 0.001 | |
| | orange | | | | - | 98-932.3 | 98-922.3 | 98-902.3 | 1 | 0.001 | |
| | red | | | | - | 98-932.2 | 98-922.2 | 98-902.2 | 1 | 0.001 | |
| | | | | | RAL 3016 | 96-932.2 | 96-922.2 | 96-902.2 | 1 | 0.001 | |
| | white | - | 98-932.9 | 98-922.9 | 98-902.9 | 1 | 0.001 | | | | |
| | yellow | - | 98-932.4 | 98-922.4 | 98-902.4 | 1 | 0.001 | | | | |
| | 2 | 2 | 2 | black | RAL 9011 | 96-933.0 | 96-923.0 | 96-903.0 | 1 | 0.001 | |
| | | | | blue | - | 98-933.6 | 98-923.6 | 98-903.6 | 1 | 0.001 | |
| | | | | green | - | 98-933.5 | 98-923.5 | 98-903.5 | 1 | 0.001 | |
| | | | | | RAL 6005 | 96-933.5 | 96-923.5 | 96-903.5 | 1 | 0.001 | |
| | | | | grey | - | 98-933.8 | 98-923.8 | 98-903.8 | 1 | 0.001 | |
| | | | | | RAL 7012 | 96-933.8 | 96-923.8 | 96-903.8 | 1 | 0.001 | |
| | | | | orange | - | 98-933.3 | 98-923.3 | 98-903.3 | 1 | 0.001 | |
| | | | | red | - | 98-933.2 | 98-923.2 | 98-903.2 | 1 | 0.001 | |
| RAL 3016 | | | | | 96-933.2 | 96-923.2 | 96-903.2 | 1 | 0.001 | | |
| white | - | 98-933.9 | 98-923.9 | 98-903.9 | 1 | 0.001 | | | | | |
| yellow | - | 98-933.4 | 98-923.4 | 98-903.4 | 1 | 0.001 | | | | | |

Switching action: MA = Maintained action, M = Momentary action
 Technical drawing from page 87

Lens standard single for film insert

| | Switching action | Recess for LED | Lens | Colour | Ø 17.4 x 17.4 mm Typ-Nr. | Technical drawing |  | | |
|--------------------------------------|------------------|----------------|----------------|-----------------|-----------------------------|-------------------|---|-------|-------|
| Lens standard single for film insert | MA | 0 | Plastic black | RAL 9011 | 96-945.0 | 4 | 0.001 | | |
| | | | Plastic blue | - | 98-945.6 | 4 | 0.001 | | |
| | | | Plastic green | - | 98-945.5 | 4 | 0.001 | | |
| | | | | RAL 6005 | 96-945.5 | 4 | 0.001 | | |
| | | | Plastic grey | - | 98-945.8 | 4 | 0.001 | | |
| | | | | RAL 7012 | 96-945.8 | 4 | 0.001 | | |
| | | | Plastic orange | - | 98-945.3 | 4 | 0.001 | | |
| | | | Plastic red | - | 98-945.2 | 4 | 0.001 | | |
| | | | | RAL 3016 | 96-945.2 | 4 | 0.001 | | |
| | | Plastic white | - | 98-945.9 | 4 | 0.001 | | | |
| | | Plastic yellow | - | 98-945.4 | 4 | 0.001 | | | |
| | | 1 | 1 | 0 | Plastic black | RAL 9011 | 96-946.0 | 4 | 0.001 |
| | | | | | Plastic blue | - | 98-946.6 | 4 | 0.001 |
| | | | | | Plastic green | - | 98-946.5 | 4 | 0.001 |
| | | | | RAL 6005 | | 96-946.5 | 4 | 0.001 | |
| | | | | Plastic grey | - | 98-946.8 | 4 | 0.001 | |
| | | | | | RAL 7012 | 96-946.8 | 4 | 0.001 | |
| | | | | Plastic orange | - | 98-946.3 | 4 | 0.001 | |
| | | | | Plastic red | - | 98-946.2 | 4 | 0.001 | |
| | | | | | RAL 3016 | 96-946.2 | 4 | 0.001 | |
| | | Plastic white | - | 98-946.9 | 4 | 0.001 | | | |
| | | Plastic yellow | - | 98-946.4 | 4 | 0.001 | | | |
| | | 2 | 2 | 0 | Plastic black | RAL 9011 | 96-947.0 | 4 | 0.001 |
| | | | | | Plastic blue | - | 98-947.6 | 4 | 0.001 |
| | | | | | Plastic green | - | 98-947.5 | 4 | 0.001 |
| | | | | RAL 6005 | | 96-947.5 | 4 | 0.001 | |
| | | | | Plastic grey | - | 98-947.8 | 4 | 0.001 | |
| | | | | | RAL 7012 | 96-947.8 | 4 | 0.001 | |
| | | | | Plastic orange | - | 98-947.3 | 4 | 0.001 | |
| | | | | Plastic red | - | 98-947.2 | 4 | 0.001 | |
| | | | | | RAL 3016 | 96-947.2 | 4 | 0.001 | |
| | | Plastic white | - | 98-947.9 | 4 | 0.001 | | | |
| | | Plastic yellow | - | 98-947.4 | 4 | 0.001 | | | |



Continuation see I

Continued from previous page

| | Switching action | Recess for LED | Lens | Colour | Ø 17.4 x 17.4 mm Typ-Nr. | Technical drawing |  | | |
|---|------------------|----------------|----------------|-----------------|-----------------------------|-------------------|---|---|-------|
| Lens standard single for film insert | M | 0 | Plastic black | RAL 9011 | 96-941.0 | 4 | 0.001 | | |
| | | | Plastic blue | - | 98-941.6 | 4 | 0.001 | | |
| | | | Plastic green | - | 98-941.5 | 4 | 0.001 | | |
| | | | | RAL 6005 | 96-941.5 | 4 | 0.001 | | |
| | | | Plastic grey | - | 98-941.8 | 4 | 0.001 | | |
| | | | | RAL 7012 | 96-941.8 | 4 | 0.001 | | |
| | | | Plastic orange | - | 98-941.3 | 4 | 0.001 | | |
| | | | Plastic red | - | 98-941.2 | 4 | 0.001 | | |
| | | | | RAL 3016 | 96-941.2 | 4 | 0.001 | | |
| | | Plastic white | - | 98-941.9 | 4 | 0.001 | | | |
| | | Plastic yellow | - | 98-941.4 | 4 | 0.001 | | | |
| | | 1 | 1 | 1 | Plastic black | RAL 9011 | 96-942.0 | 4 | 0.001 |
| | | | | | Plastic blue | - | 98-942.6 | 4 | 0.001 |
| | | | | | Plastic green | - | 98-942.5 | 4 | 0.001 |
| | | | | | | RAL 6005 | 96-942.5 | 4 | 0.001 |
| | | | | | Plastic grey | - | 98-942.8 | 4 | 0.001 |
| | | | | | | RAL 7012 | 96-942.8 | 4 | 0.001 |
| | | | | | Plastic orange | - | 98-942.3 | 4 | 0.001 |
| | | | | | Plastic red | - | 98-942.2 | 4 | 0.001 |
| | | | | | | RAL 3016 | 96-942.2 | 4 | 0.001 |
| | | Plastic white | - | 98-942.9 | 4 | 0.001 | | | |
| | | Plastic yellow | - | 98-942.4 | 4 | 0.001 | | | |
| | | 2 | 2 | 2 | Plastic black | RAL 9011 | 96-943.0 | 4 | 0.001 |
| | | | | | Plastic blue | - | 98-943.6 | 4 | 0.001 |
| | | | | | Plastic green | - | 98-943.5 | 4 | 0.001 |
| | | | | | | RAL 6005 | 96-943.5 | 4 | 0.001 |
| | | | | | Plastic grey | - | 98-943.8 | 4 | 0.001 |
| | | | | | | RAL 7012 | 96-943.8 | 4 | 0.001 |
| | | | | | Plastic orange | - | 98-943.3 | 4 | 0.001 |
| | | | | | Plastic red | - | 98-943.2 | 4 | 0.001 |
| | | | | | | RAL 3016 | 96-943.2 | 4 | 0.001 |
| | | Plastic white | - | 98-943.9 | 4 | 0.001 | | | |
| | | Plastic yellow | - | 98-943.4 | 4 | 0.001 | | | |

Switching action: MA = Maintained action, M = Momentary action
 Technical drawing from page 87

Lens Euro-Style single

| Lens Euro-Style single | Switching action | Recess for LED | Lens | Colour | □ 12.4 x 17.4 mm Typ-Nr. | Technical drawing | |
|------------------------|------------------|----------------|---------------|------------------|-----------------------------|-------------------|-------|
| | | | | | | kg | |
| Lens Euro-Style single | MA | 0 | Plastic black | RAL 9011 | 96-905.01 | 5 | 0.001 |
| | | | Plastic green | RAL 6005 | 96-905.51 | 5 | 0.001 |
| | | | Plastic grey | RAL 7012 | 96-905.81 | 5 | 0.001 |
| | | | Plastic red | RAL 3016 | 96-905.21 | 5 | 0.001 |
| | | 1 | Plastic black | RAL 9011 | 96-906.01 | 5 | 0.001 |
| | | | Plastic green | RAL 6005 | 96-906.51 | 5 | 0.001 |
| | | | Plastic grey | RAL 7012 | 96-906.81 | 5 | 0.001 |
| | | | Plastic red | RAL 3016 | 96-906.21 | 5 | 0.001 |
| | | 2 | Plastic black | RAL 9011 | 96-907.01 | 5 | 0.001 |
| | | | Plastic green | RAL 6005 | 96-907.51 | 5 | 0.001 |
| | | | Plastic grey | RAL 7012 | 96-907.81 | 5 | 0.001 |
| | | | Plastic red | RAL 3016 | 96-907.21 | 5 | 0.001 |
| | M | 0 | Plastic black | RAL 9011 | 96-901.01 | 5 | 0.001 |
| | | | Plastic green | RAL 6005 | 96-901.51 | 5 | 0.001 |
| | | | Plastic grey | RAL 7012 | 96-901.81 | 5 | 0.001 |
| | | | Plastic red | RAL 3016 | 96-901.21 | 5 | 0.001 |
| 1 | | Plastic black | RAL 9011 | 96-902.01 | 5 | 0.001 | |
| | | Plastic green | RAL 6005 | 96-902.51 | 5 | 0.001 | |
| | | Plastic grey | RAL 7012 | 96-902.81 | 5 | 0.001 | |
| | | Plastic red | RAL 3016 | 96-902.21 | 5 | 0.001 | |
| 2 | | Plastic black | RAL 9011 | 96-903.01 | 5 | 0.001 | |
| | | Plastic green | RAL 6005 | 96-903.51 | 5 | 0.001 | |
| | | Plastic grey | RAL 7012 | 96-903.81 | 5 | 0.001 | |
| | | Plastic red | RAL 3016 | 96-903.21 | 5 | 0.001 | |

Switching action: MA = Maintained action, M = Momentary action
 Technical drawing from page 87

Lens standard double

for two switching elements

| Lens standard double | Switching action | Recess for LED | Lens | Colour | □ 17.4 x 35.2 mm Typ-Nr. | Technical drawing | |
|----------------------|------------------|----------------|---------------|----------|-----------------------------|-------------------|-------|
| | | | | | | kg | |
| Lens standard double | M | 0 | Plastic black | RAL 9011 | 96-951.0 | 6 | 0.002 |
| | | | Plastic green | RAL 6005 | 96-951.5 | 6 | 0.002 |
| | | | Plastic grey | RAL 7012 | 96-951.8 | 6 | 0.002 |
| | | | Plastic red | RAL 3016 | 96-951.2 | 6 | 0.002 |

Switching action: M = Momentary action
 Technical drawing from page 87

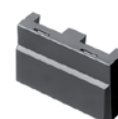

Blind plug

| | Blind plug | Colour | ∅ 17.4 x 17.4 mm Typ-Nr. | ∅ 14.8 x 17.4 mm Typ-Nr. | ∅ 12.4 x 17.4 mm Typ-Nr. |  |
|-------------------|---------------|----------|-----------------------------|-----------------------------|-----------------------------|---|
| Blind plug | Plastic black | RAL 9011 | 96-938.0 | 96-928.0 | 96-908.0 | 0.001 |
| | Plastic green | RAL 6005 | 96-938.5 | 96-928.5 | 96-908.5 | 0.001 |
| | Plastic grey | RAL 7012 | 96-938.8 | 96-928.8 | 96-908.8 | 0.001 |
| | Plastic red | RAL 3016 | 96-938.2 | 96-928.2 | 96-908.2 | 0.001 |



Illumination

Single LED standard

| | Socket | Light colour | Operating voltage/-current | Typ-Nr. |  |
|---|-----------|--------------|----------------------------|----------------------|---|
| Single LED standard without serie resistor, with special pin crank | T1 Bi-Pin | gelb | 2.2 VDC, 20 mA | 10-2602.3174E | 0.001 |
| | | grün | 2.2 VDC, 20 mA | 10-2602.3175E | 0.001 |
| | | rot | 2.2 VDC, 20 mA | 10-2602.3172E | 0.001 |



Single LED Euro Style

| | Socket | Light colour | Operating voltage/-current | Typ-Nr. |  |
|---|-----------|--------------|----------------------------|----------------------|---|
| Single LED Euro Style without serie resistor, with special pin crank | T1 Bi-Pin | green | 2.2 VDC, 20 mA | 10-2602.3175J | 0.001 |
| | | red | 2.2 VDC, 20 mA | 10-2602.3172J | 0.001 |
| | | yellow | 2.2 VDC, 20 mA | 10-2602.3174J | 0.001 |



Assembling

Lens remover

| | Typ-Nr. |  |
|---------------------|---------------|---|
| Lens remover | 98-968 | 0.004 |



Snap-action switching element

Switching system

Single-break, self-cleaning, snap-action switching element with tactile feel of operation.

Material

lens Euro-Style

ABS/PC or ABS, self-extinguishing

Housing

Polyester, self-extinguishing

Material of contact

Gold-plated on nickel

Front protection

IP 67, as per IEC 60529

Shock resistance

(single impacts, semi-sinusoidal)
≥30 g for 11 ms as per IEC 60512-4-3

Vibration resistance

(sinusoidal)
10 g at 10 Hz ... 2000 Hz, amplitude 0.75 mm, as per IEC 60512-4-4

Mechanical characteristics

Terminals

PCB terminal

Actuating force

Actuating force 1.4 N ±0.3 N

Actuating travel

Lead distance 1.0 mm ±0.3 mm

Total distance 1.7 mm ±0.5 mm

Mechanical lifetime

≥5 million operations, as per IEC 60512-5-9a

Rebound time

≤2.5 ms

Electrical characteristics

Contact resistance

Starting value (initial) ≤100 mΩ, as per IEC 60512-2-2b

Isolation resistance

≥10¹² Ω between contacts at 100 VDC, as per IEC 60512-2-3a

Capacity

Between contacts ≤1 pF

Electrical life

≥5 x 100.000 operations at 30 VDC, 100 mA, as per IEC 60512-5, test 9c

Conventional free air thermal current I_{th2}

100 mA

Switch rating

Electric strength

500 VAC, 50 Hz, 1 min. between all terminals and earth, as per IEC 60512-2-11

Environmental conditions

Storage temperature

-40 °C ... +85 °C

Service temperature

-25 °C ... +85 °C

General notes

1. Engraving

In addition to the most commonly used world languages, in DIN 1451-3 close spacing, other typefaces are available as Scandinavian, Slavic, Greek, Russian and Polish.

Red, blue and black lenses are filled with white colour. Other colour lenses are filled in black. Standard height of letters is 2 mm. If the height is not specified, we will supply 2 mm engraved letters.

2. Hot stamping

On request. We will be pleased to advise you.

3. Film inserts

A special lens, 17.4 x 17.4 mm, available for insertion of a colour foil or film. The film thickness is 0.2 mm.

Lenses standard

All dimensions in mm

| Front size | Film insert max. size | Height of letters h | Labeling field - A - | | | Labeling field - B - | | | Image |
|-------------|-----------------------|---------------------|----------------------|---|---|----------------------|---|---|-------|
| | | | Number of lines | Number of (target value) capital letters per line | Number of (target value) small letters per line | Number of lines | Number of (target value) capital letters per line | Number of (target value) small letters per line | |
| 12.4 x 17.4 | - | 2 | 1 | 6 | 6 - 7 | 2 | 5 | 6 - 7 | B1 |
| | - | 3 | 1 | 4 | 5 | 2 | 4 | 4 - 5 | B1 |
| | - | 4 | 1 | 3 - 4 | 4 | 1 | 3 - 4 | 4 | B1 |
| | - | 5 | - | - | - | 1 | 2 - 3 | 3 | B1 |
| | - | 6 | - | - | - | 1 | 2 | 2 | B1 |
| | - | 8 | - | - | - | 1 | 1 | 1 | B1 |
| 14.8 x 17.4 | - | 2 | 1 | 7 | 7 - 8 | 2 | 6 | 7 - 8 | B2 |
| | - | 3 | 1 | 5 - 6 | 6 - 7 | 2 | 5 | 6 | B2 |
| | - | 4 | 1 | 4 | 4 - 5 | 1 | 4 | 4 | B2 |
| | - | 5 | - | - | - | 1 | 3 | 3 - 4 | B2 |
| | - | 6 | - | - | - | 1 | 2 - 3 | 3 | B2 |
| | - | 8 | - | - | - | 1 | 1 - 3 | 2 | B2 |
| 17.4 x 17.4 | - | 2 | 1 | 8 - 9 | 9 - 10 | 2 | 7 - 8 | 8 - 9 | B3 |
| | 7 x 12 | 2 | 1 | 8 - 9 | 9 - 10 | - | - | - | B4 |
| | - | 3 | 1 | 7 - 8 | 8 - 9 | 2 | 6 - 7 | 7 - 8 | B3 |
| | 7 x 12 | 3 | 1 | 7 - 8 | 8 - 9 | - | - | - | B4 |
| | - | 4 | 1 | 5 | 5 - 6 | 1 | 4 - 5 | 5 - 6 | B3 |
| | 7 x 12 | 4 | 1 | 5 | 5 - 6 | - | - | - | B4 |
| | - | 5 | - | - | - | 1 | 3 - 4 | 4 | B3 |
| | 7 x 12 | 5 | - | - | - | - | - | - | B4 |
| | - | 6 | - | - | - | 1 | 2 - 3 | 3 | B3 |
| | 7 x 12 | 6 | - | - | - | - | - | - | B4 |
| | - | 8 | - | - | - | 1 | 2 | 2 - 3 | B3 |
| 7 x 12 | 8 | - | - | - | - | - | - | B4 | |

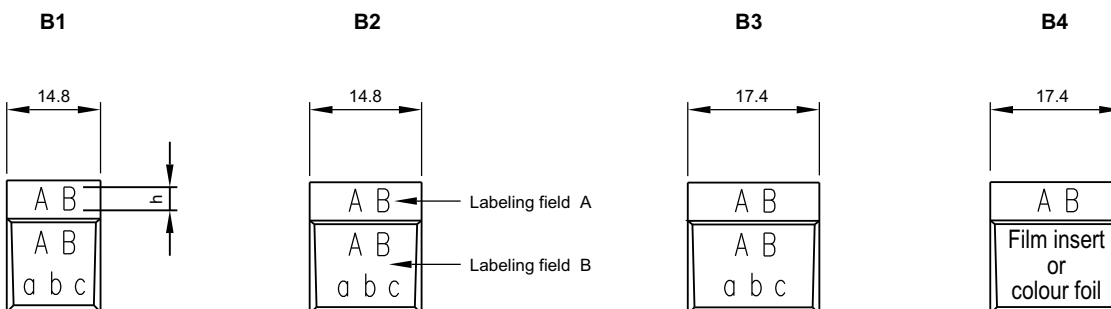

Component layout

1 Indicator page 77

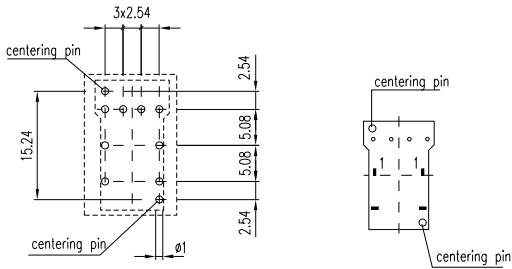

2 Illuminated pushbutton page 77

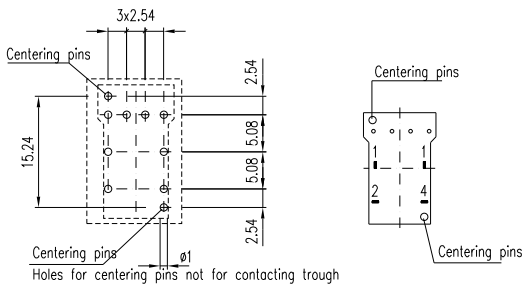

Technical drawing

1 Lens standard single page 79

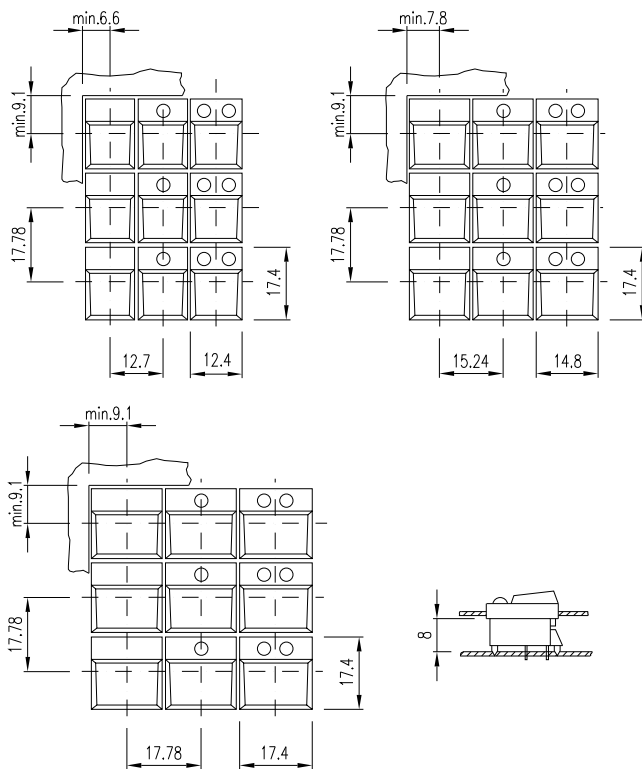

2 Indicator page 77 | Cap for Indicator page 78

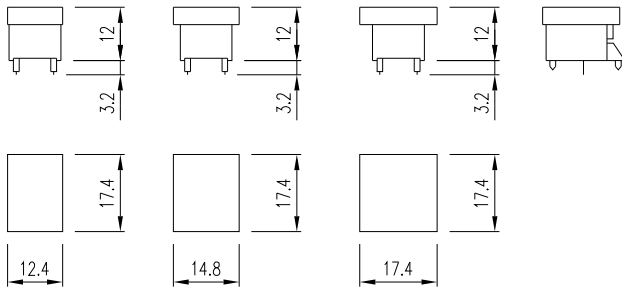

3 Illuminated pushbutton page 77

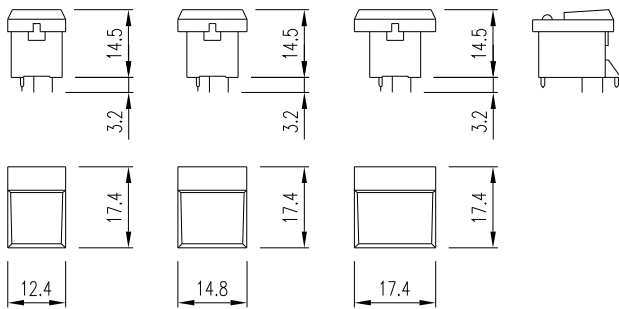

4 Lens standard single for film insert page 81

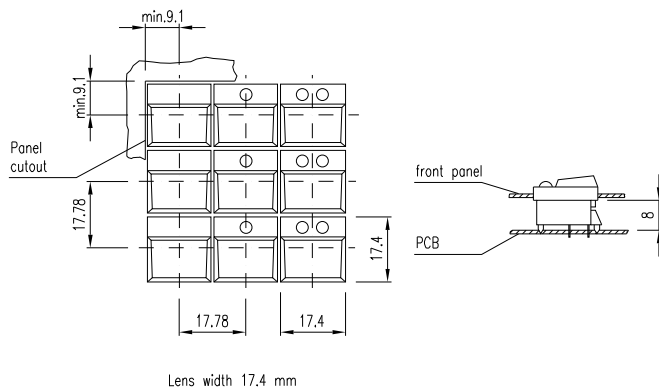

5 Lens Euro-Style single page 83

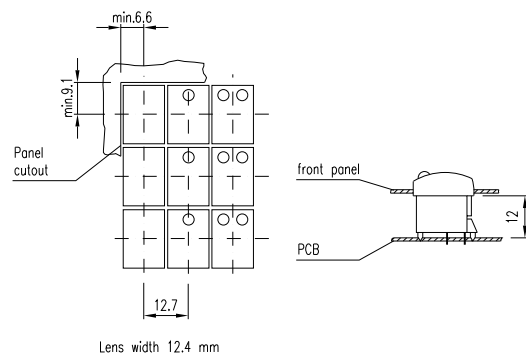

6 Lens standard double page 83

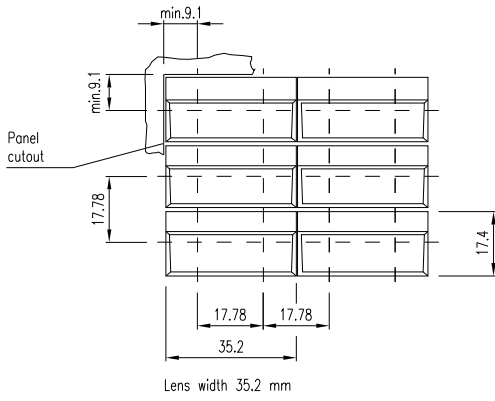

Circuit drawing

1 Illuminated pushbutton page 77





| | |
|--------------------------------------|------------|
| Description | 93 |
| Product Assembly | 94 |
| Devices raised mounting | 95 |
| Devices flush mounting | 96 |
| Accessories..... | 97 |
| Technical Data..... | 100 |
| Drawings..... | 101 |
| Index..... | 159 |

Product Information

General notes

The series 18 comprises compact indicators for direct connection to 2.2, 12 or 24 VDC and illuminated pushbuttons with maintained or momentary action.

The illuminated pushbuttons are equipped with a snap-action switching system with normally open or normally closed contacts.

The dimensions of the front are 9 x 14 mm, 9 x 9 mm or 9 mm dia.

Indicators and illuminated pushbuttons for use with overhanging lenses 14 x 14 mm or 14 mm dia. are also available for flush mounting.

Mounting

Mounting from the front through the mounting hole 8 mm dia.

(15.8 x 15.8 mm resp. 16 mm dia. for flush mounting) is assured even with the wiring already attached.

The units are provided with soldering terminals.

Lenses

The flat lenses are available in various colours and a transparent version. The surface is nonreflecting (matt).

Illumination

Perfect illumination of the lenses, which can be supplied in various colours, is assured by Bi-Pin T1 LEDs (2.2 VDC) in the colours red, yellow and green.

(Compact indicators for connection to 12 or 24 VDC.) The Bi-Pin T1 LED are already integrated in the lenses.

Luminosity and wave length scattering caused by the technology used in the LED manufacturing processes may lead to visual differences in our products.

Position indication

The status of a maintained action switch can be determined by the position of the lens.

Specimen order

Illuminated pushbutton :

- Illuminated pushbutton actuator, 9 x14 mm, 18-147.035
momentary action, 1 normally open, soldering terminal

Essential accessories :

- Lens with LED plastic yellow, transparent, 18-941.4
flush, 9 x 14 mm

We reserve the right to modify technical data

All dimensions in mm

Pushbutton illuminative, raised mounting

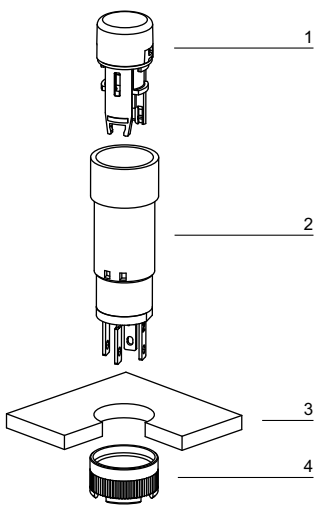

- 1 Lens
- 2 Switch housing
- 3 Front panel
- 4 Fixing nut

Pushbutton illuminative, flush mounting

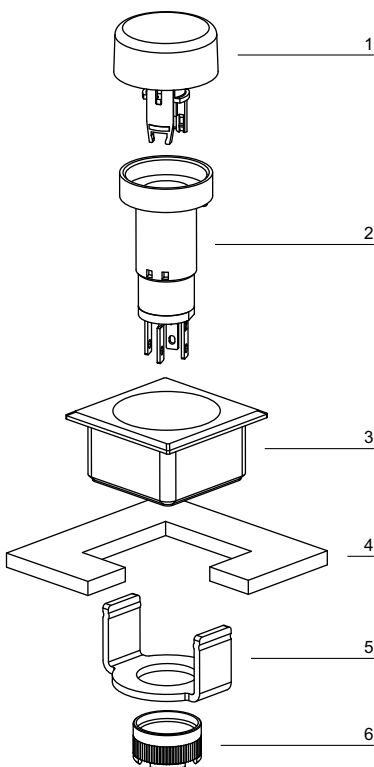

- 1 Lens
- 2 Switch housing
- 3 Front bezel set (upper part)
- 4 Front panel
- 5 Front bezel set (lower part)
- 6 Fixing nut

Indicator



| Indicator | Front protection | Operating voltage/-current | Lens | Terminals | Ø 9 x 9 mm Typ-Nr. | Ø 9 x 14 mm Typ-Nr. | Ø 9 mm Typ-Nr. | Component layout | | | | 0.002 |
|-----------|------------------|----------------------------|----------------|-----------|-----------------------|------------------------|--------------------|---------------------|-------------------|-----------------|---|-------|
| | | | | | | | | Mounting dimensions | Technical drawing | Circuit drawing | | |
| Indicator | IP 40 | 12 VDC, 20 mA | Plastic green | S | 18-051.0055 | 18-041.0055 | 18-031.0055 | 1 | 1 | 1 | 1 | 0.002 |
| | | | Plastic red | S | 18-051.0052 | 18-041.0052 | 18-031.0052 | 1 | 1 | 1 | 1 | 0.002 |
| | | | Plastic yellow | S | 18-051.0054 | 18-041.0054 | 18-031.0054 | 1 | 1 | 1 | 1 | 0.002 |
| | | 2.2 VDC, 20 mA | Plastic green | S | 18-050.0055 | 18-040.0055 | 18-030.0055 | 1 | 1 | 1 | 1 | 0.002 |
| | | | Plastic red | S | 18-050.0052 | 18-040.0052 | 18-030.0052 | 1 | 1 | 1 | 1 | 0.002 |
| | | | Plastic yellow | S | 18-050.0054 | 18-040.0054 | 18-030.0054 | 1 | 1 | 1 | 1 | 0.002 |
| | | 24 VDC, 20 mA | Plastic green | S | 18-052.0055 | 18-042.0055 | 18-032.0055 | 1 | 1 | 1 | 1 | 0.002 |
| | | | Plastic red | S | 18-052.0052 | 18-042.0052 | 18-032.0052 | 1 | 1 | 1 | 1 | 0.002 |
| | | | Plastic yellow | S | 18-052.0054 | 18-042.0054 | 18-032.0054 | 1 | 1 | 1 | 1 | 0.002 |

Terminals: S = Soldering terminal

Component layout from page 101, Mounting dimensions from page 102, Technical drawing from page 102, Circuit drawing from page 103

Illuminated pushbutton actuator



Essential Accessories:

 Lens with LED page 97

| Illuminated pushbutton actuator | Front protection | Switching system | Contacts | Switching action | Terminals | Ø 9 x 9 mm Typ-Nr. | Ø 9 x 14 mm Typ-Nr. | Ø 9 mm Typ-Nr. | Component layout | | | | 0.002 |
|---------------------------------|------------------|------------------|----------|------------------|-----------|-----------------------|------------------------|-------------------|---------------------|-------------------|-----------------|---|-------|
| | | | | | | | | | Mounting dimensions | Technical drawing | Circuit drawing | | |
| Illuminated pushbutton actuator | IP 40 | SA | 1 NC | MA | S | 18-258.035 | 18-248.035 | 18-238.035 | 2 | 1 | 2 | 2 | 0.002 |
| | | | | M | S | 18-158.035 | 18-148.035 | 18-138.035 | 2 | 1 | 2 | 4 | 0.002 |
| | | | 1 NO | MA | S | 18-257.035 | 18-247.035 | 18-237.035 | 2 | 1 | 2 | 3 | 0.002 |
| | | | | M | S | 18-157.035 | 18-147.035 | 18-137.035 | 2 | 1 | 2 | 5 | 0.002 |

Switching system: SA = Snap-action switching element

Contacts: NC = Normally closed, NO = Normally open

Switching action: MA = Maintained action, M = Momentary action

Terminals: S = Soldering terminal

Component layout from page 101, Mounting dimensions from page 102, Technical drawing from page 102, Circuit drawing from page 103

Indicator actuator, flush mounting



Essential Accessories:

Front bezel set, flush mounting page 98

| | Front protection | Operating voltage/-current | Lens | Terminals | □ 19 x 19 mm Typ-Nr. | Ø 19 mm Typ-Nr. | Component layout | | | | ④ |
|---|------------------|----------------------------|----------------|--------------------|-------------------------|--------------------|---------------------|-------------------|-----------------|-------|-------|
| | | | | | | | Mounting dimensions | Technical drawing | Circuit drawing | | |
| Indicator actuator, flush mounting | IP 40 | 12 VDC, 20 mA | Plastic green | S | 18-081.0055 | 18-061.0055 | 2 | 2 | 3 | 1 | 0.003 |
| | | | Plastic red | S | 18-081.0052 | 18-061.0052 | 2 | 2 | 3 | 1 | 0.003 |
| | | | Plastic yellow | S | 18-081.0054 | 18-061.0054 | 2 | 2 | 3 | 1 | 0.003 |
| | 2.2 VDC, 20 mA | Plastic green | S | 18-080.0055 | 18-060.0055 | 2 | 2 | 3 | 1 | 0.002 | |
| | | Plastic red | S | 18-080.0052 | 18-060.0052 | 2 | 2 | 3 | 1 | 0.002 | |
| | | Plastic yellow | S | 18-080.0054 | 18-060.0054 | 2 | 2 | 3 | 1 | 0.002 | |
| | 24 VDC, 20 mA | Plastic green | S | 18-082.0055 | 18-062.0055 | 2 | 2 | 3 | 1 | 0.003 | |
| | | Plastic red | S | 18-082.0052 | 18-062.0052 | 2 | 2 | 3 | 1 | 0.003 | |
| | | Plastic yellow | S | 18-082.0054 | 18-062.0054 | 2 | 2 | 3 | 1 | 0.003 | |

Terminals: S = Soldering terminal

Component layout from page 101, Mounting dimensions from page 102, Technical drawing from page 102, Circuit drawing from page 103

Illuminated pushbutton actuator, flush mounting



Essential Accessories:

Front bezel set, flush mounting page 98

Lens with LED, flush mounting page 97

| | Front protection | Switching system | Contacts | Switching action | Terminals | □ 19 x 19 mm Typ-Nr. | Ø 19 mm Typ-Nr. | Component layout | | | | ④ |
|--|------------------|------------------|----------|------------------|-----------|-------------------------|--------------------|---------------------|-------------------|-----------------|---|-------|
| | | | | | | | | Mounting dimensions | Technical drawing | Circuit drawing | | |
| Illuminated pushbutton actuator, flush mounting | IP 40 | SA | 1 NC | MA | S | 18-288.035 | 18-268.035 | 2 | 2 | 4 | 2 | 0.002 |
| | | | | M | S | 18-188.035 | 18-168.035 | 2 | 2 | 4 | 4 | 0.002 |
| | | | 1 NO | MA | S | 18-287.035 | 18-267.035 | 2 | 2 | 4 | 3 | 0.002 |
| | | | | M | S | 18-187.035 | 18-167.035 | 2 | 2 | 4 | 5 | 0.002 |

Switching system: SA = Snap-action switching element

Contacts: NC = Normally closed, NO = Normally open

Switching action: MA = Maintained action, M = Momentary action

Terminals: S = Soldering terminal

Component layout from page 101, Mounting dimensions from page 102, Technical drawing from page 102, Circuit drawing from page 103

Front

Lens without LED

| | Lens | ∅ 9 x 9 mm Typ-Nr. | ∅ 9 x 14 mm Typ-Nr. | ∅ 9 mm Typ-Nr. |  |
|---|----------------------------------|-----------------------|------------------------|-------------------|---|
| Lens without LED illuminative | Plastic green translucent flush | 18-952.5 | 18-942.5 | 18-932.5 | 0.001 |
| | Plastic red translucent flush | 18-952.2 | 18-942.2 | 18-932.2 | 0.001 |
| | Plastic white translucent flush | 18-952.9 | 18-942.9 | 18-932.9 | 0.001 |
| | Plastic yellow translucent flush | 18-952.4 | 18-942.4 | 18-932.4 | 0.001 |
| non-illuminative | Plastic black opaque flush | 18-952.0 | 18-942.0 | 18-932.0 | 0.001 |
| | Plastic grey opaque flush | 18-952.8 | 18-942.8 | 18-932.8 | 0.001 |



Lens with LED

| | Lens | ∅ 9 x 9 mm Typ-Nr. | ∅ 9 x 14 mm Typ-Nr. | ∅ 9 mm Typ-Nr. |  |
|--|----------------------------------|-----------------------|------------------------|-------------------|---|
| Lens with LED without built-in series resistor, typ. forward voltage 2.2 VDC, 20 mA | Plastic green translucent flush | 18-951.5 | 18-941.5 | 18-931.5 | 0.001 |
| | Plastic red translucent flush | 18-951.2 | 18-941.2 | 18-931.2 | 0.001 |
| | Plastic yellow translucent flush | 18-951.4 | 18-941.4 | 18-931.4 | 0.001 |



Lens without LED, flush mounting

| | Lens | ∅ 19 x 19 mm Typ-Nr. | ∅ 19 mm Typ-Nr. |  |
|---|----------------------------------|-------------------------|--------------------|---|
| Lens without LED, flush mounting illuminative | Plastic green translucent flush | 18-982.5 | 18-962.5 | 0.001 |
| | Plastic red translucent flush | 18-982.2 | 18-962.2 | 0.001 |
| | Plastic white translucent flush | 18-982.9 | 18-962.9 | 0.001 |
| | Plastic yellow translucent flush | 18-982.4 | 18-962.4 | 0.001 |
| non-illuminative | Plastic black opaque flush | 18-982.0 | 18-962.0 | 0.001 |
| | Plastic grey opaque flush | 18-982.8 | 18-962.8 | 0.001 |



Lens with LED, flush mounting

| | Lens | ∅ 19 x 19 mm Typ-Nr. | ∅ 19 mm Typ-Nr. |  |
|--|----------------------------------|-------------------------|--------------------|---|
| Lens with LED, flush mounting without built-in series resistor, typ. forward voltage 2.2 VDC, 20 mA | Plastic green translucent flush | 18-981.5 | 18-961.5 | 0.001 |
| | Plastic red translucent flush | 18-981.2 | 18-961.2 | 0.001 |
| | Plastic yellow translucent flush | 18-981.4 | 18-961.4 | 0.001 |



Front bezel set, flush mounting

| | | ∅ 19 x 19 mm Typ-Nr. | ∅ 19 mm Typ-Nr. | Mounting dimensions | |
|--|---------------|-------------------------|--------------------|---------------------|-------|
| Front bezel set, flush mounting for Lens round | Plastic black | 18-920.2 | 18-920.3 | 2 | 0.006 |
| for Lens square | Plastic black | 18-920.1 | | 2 | 0.006 |

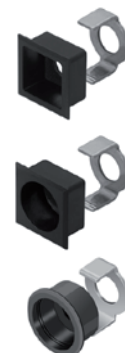

Mounting dimensions from page 102

Blind plug

| | | ∅ 9 x 9 mm Typ-Nr. | ∅ 9 mm Typ-Nr. | Mounting dimensions | |
|-------------------|--|-----------------------|-------------------|---------------------|-------|
| Blind plug | | 19-948.0 | 19-949.0 | 3 | 0.001 |



Mounting dimensions from page 102

Backside

PCB plug-in base

| | Terminals | Typ-Nr. | Component layout | Technical drawing | |
|---------------------------------------|-----------|---------------|------------------|-------------------|-------|
| PCB plug-in base Pins axial | P | 18-945 | 3 | 5 | 0.001 |
| Pins bent at right-angles | P | 18-946 | 4 | 6 | 0.001 |



Terminals: P = PCB terminal

Component layout from page 101, Technical drawing from page 102

Assembling

Lens remover

| | Typ-Nr. | |
|---------------------|---------------|-------|
| Lens remover | 18-910 | 0.002 |



Mounting tool

| | Typ-Nr. |  |
|--|---------------|---|
| Mounting tool for Fixing nut long 19-991 | 19-905 | 0.011 |



Actuator with snap-action switching element

Switching system

The snap-action switching system was designed for switching low powers in electronic circuits.
Single-break snap-action contact.

Material

Lens

Polymethylacrylate (PMMA), Polycarbonate (PC)

Material of contact

Gold contact on nickel plating

Actuator housing

Polyamide, colour black

Mechanical characteristics

Terminals

The terminals can be used as soldering terminals.
Max.wire diameter: 2 x 0.5 mm²
Max.wire cross-section of stranded cable 1 x 0.75 mm²
Wire cross-section of terminal 1.6 x 0.4 mm

Tightening torque

for fixing nut max. 20 Ncm

Actuating force

1.4 N

Actuating travel

2.2 mm ±0.2 mm

Rebound time

≤2.5 ms

Mechanical lifetime

Momentary action 2 million cycles of operation
Maintained action 1 million cycles of operation,
as per IEC 60512-5-9a

Electrical characteristics

Contact resistance

≤100 mΩ starting value (initial), as per IEC 60512-2-2b

Electrical life

≥500 000 cycles of operation at 30 VDC, 100 mA, as per IEC 60512-5-9c

Power consumption LED

20 mA

Switch rating

min. 10 μA at 100 μV
max. 100 mA at 42 VAC/VDC

Electric strength

500 VAC, 50 Hz, 1 min. between all terminals and earth, as per IEC 60512-2-11

Environmental conditions

Storage temperature

-40 °C ... +80 °C

Service temperature

-25 °C ... +65 °C

Protection degree

IP 40 front side, as per IEC 60529

Shock resistance

(Single impacts, semi-sinusoidal)
50 g for 11 ms, as per IEC 60068-2-27

Vibration resistance

(sinusoidal)10 g at 10-2000 Hz, amplitude 0.75 mm, as per IEC 60512-4-4

Component layout

1 Indicator page 95

9 x 9 mm

9 x 14 mm

Ø9 mm

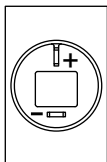
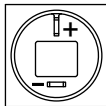

2 Illuminated pushbutton actuator page 95 | Indicator actuator, flush mounting page 96 | Illuminated pushbutton actuator, flush mounting page 96

9 x 9 mm

9 x 14 mm

Ø9 mm

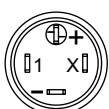
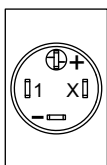
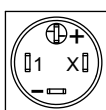

X contact-nr.
2 = NO
4 = NC

3 PCB plug-in base page 98

Drilling plan (element side)
Through-connection recommended

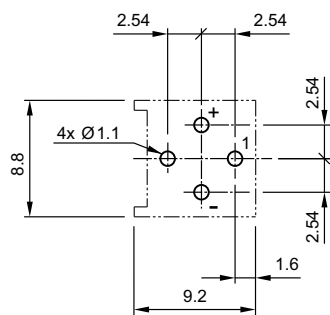

4 PCB plug-in base page 98

Drilling plan (element side)
Through-connection recommended

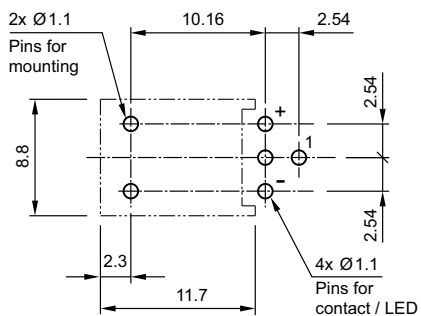

Mounting dimensions

1 Indicator page 95 | Illuminated pushbutton actuator page 95

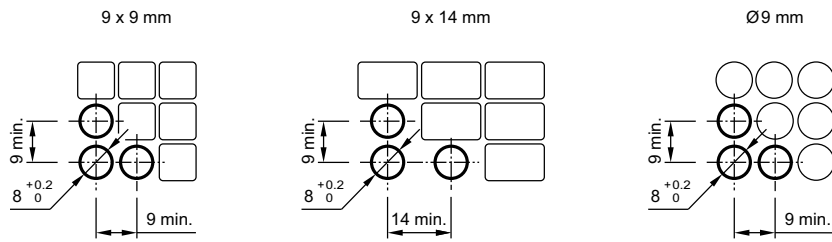

2 Indicator actuator, flush mounting page 96 | Illuminated pushbutton actuator, flush mounting page 96 | Front bezel set, flush mounting page 98

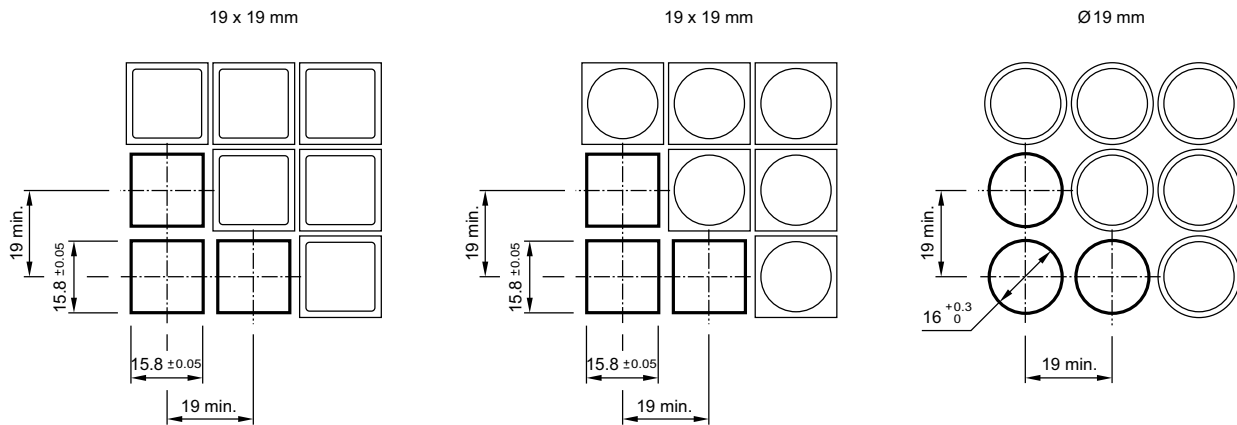

3 Blind plug page 98

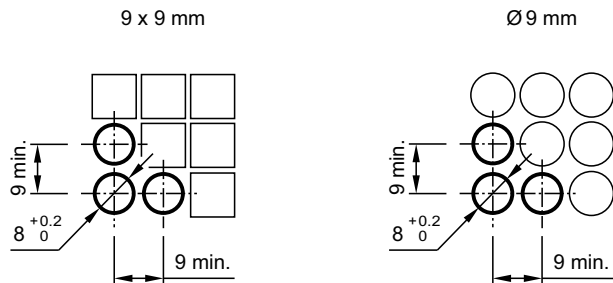

Technical drawing

1 Indicator page 95

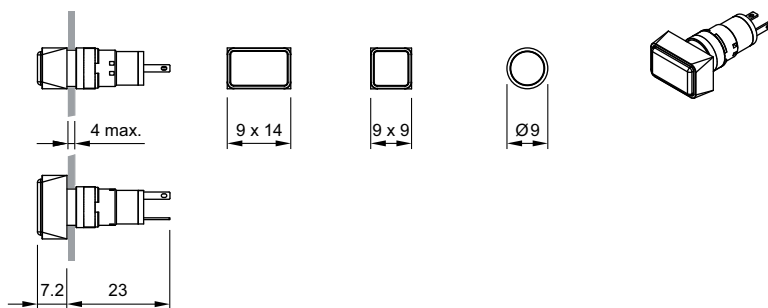

2 Illuminated pushbutton actuator page 95

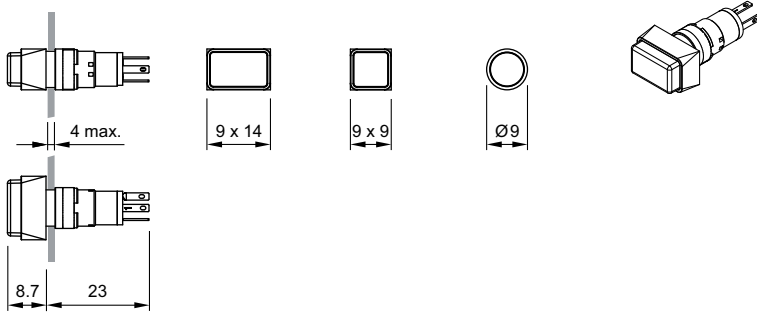

3 Indicator actuator, flush mounting page 96

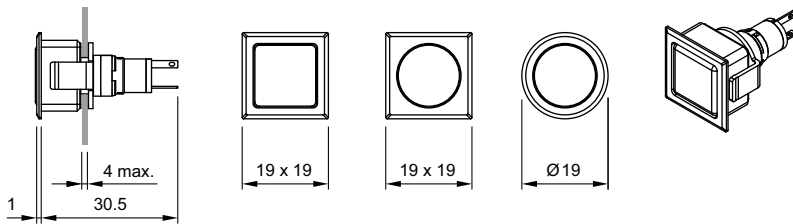

4 Illuminated pushbutton actuator, flush mounting page 96

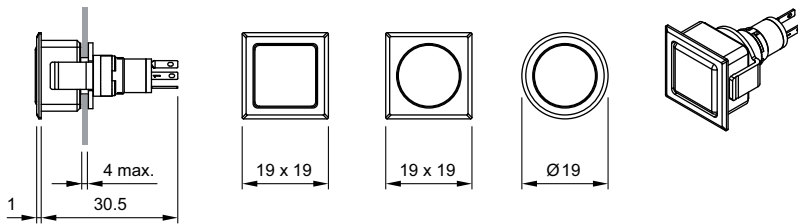

5 PCB plug-in base page 98

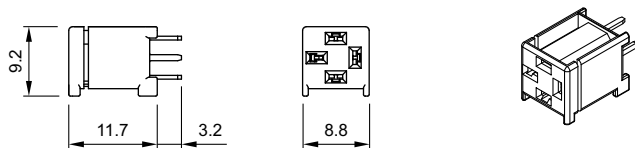

6 PCB plug-in base page 98

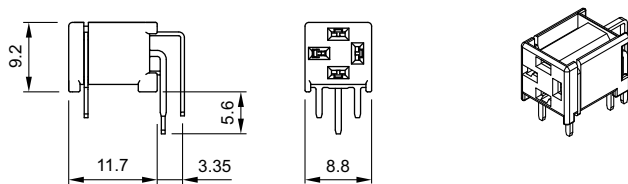

Circuit drawing

1 Indicator page 95 | Indicator actuator, flush mounting page 96



2 Illuminated pushbutton actuator page 95 | **Illuminated pushbutton actuator, flush mounting** page 96

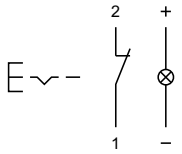

3 Illuminated pushbutton actuator page 95 | **Illuminated pushbutton actuator, flush mounting** page 96

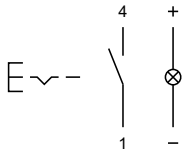

4 Illuminated pushbutton actuator page 95 | **Illuminated pushbutton actuator, flush mounting** page 96

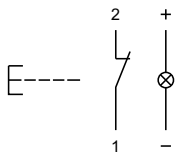

5 Illuminated pushbutton actuator page 95 | **Illuminated pushbutton actuator, flush mounting** page 96

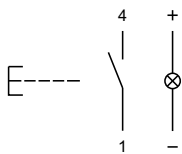



| | |
|--------------------------------------|------------|
| Description | 107 |
| Product Assembly | 108 |
| Devices raised mounting | 109 |
| Accessories | 110 |
| Technical Data..... | 113 |
| Application guidelines..... | 11 |
| Drawings..... | 115 |
| Index..... | 159 |

Product Information

General notes

The series contains indicators and illuminated pushbuttons with maintained and momentary action and one contact which may be normally closed or normally open (snap-action element for closing). The illuminated pushbuttons are fitted with snap-action or low-level switching systems.

The front dimensions are 9 x 9 mm or 9 mm dia.

Mounting

Mounting from the front through the mounting hole is assured even when the wiring has already been attached.

The units are equipped with soldering/plug-in terminals.

Lenses

The flat lenses, made of polycarbonate, are obtainable in various colours. The transparent lens is available with translucent or transparent support.

Marking

A limited amount of marking can be provided.

Illumination

Perfect illumination of the different coloured lenses is assured by filament lamps Bi-Pin T1 longlife (6 ... 24 V) or LED Bi-Pin T1. LED are available in the colours white, red, yellow, orange and green.

Luminosity and wave length scattering caused by the technology used in the LED manufacturing processes may lead to visual differences in our products.

Position indication

The status of a maintained action switch can be determined by the position of the lens.

Specimen order

Indicator :

- | | |
|---|------------|
| - Indicator actuator, 9 mm dia., soldering terminal | 19-030.005 |
|---|------------|

Essential accessories :

- | | |
|--|---------------|
| - Lens plastic blue, transparent, flush, 9 mm dia. | 19-931.6 |
| - Single-LED, T1 Bi-Pin, 3.6 VDC, weiss | 10-2603.3179C |

*We reserve the right to modify technical data
All dimensions in mm*

Indicator, raised mounting

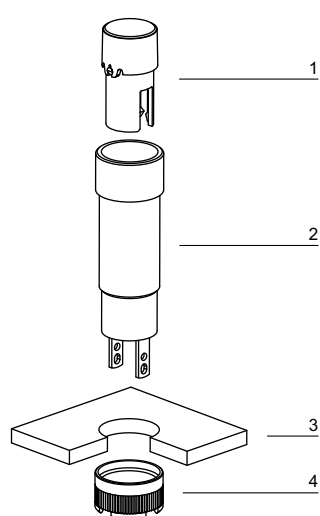

- 1 Lens
- 2 Switch housing
- 3 Front plate
- 4 Fixing nut

Pushbutton illuminative, raised mounting

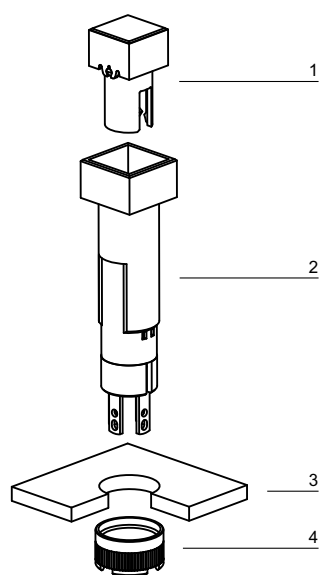

- 1 Lens
- 2 Switch housing
- 3 Front plate
- 4 Fixing nut

Indicator actuator



Essential Accessories:

- Lens page 110
- Single-LED page 111

| | Front protection | Terminals | □ 9 x 9 mm Typ-Nr. | ∅ 9 mm Typ-Nr. | Component layout | Mounting dimensions | Technical drawing | Circuit drawing | |
|---|------------------|-----------|-----------------------|-------------------|------------------|---------------------|-------------------|-----------------|-------|
| Indicator actuator Mounting depth : 25 mm | IP 40 | S2 | 19-050.005 | 19-030.005 | 1 | 1 | 1 | 1 | 0.001 |
| Mounting depth : 33 mm | IP 40 | S2 | 19-051.005 | 19-031.005 | 1 | 1 | 3 | 1 | 0.002 |

Terminals: S2 = Soldering terminal (also pluggable 2.0 x 0.5 mm)

Component layout from page 115, Mounting dimensions from page 115, Technical drawing from page 116, Circuit drawing from page 117

Illuminated pushbutton actuator

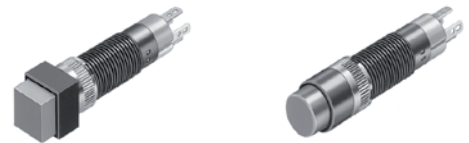

Essential Accessories:

- Lens page 110
- Single-LED page 111

| | Front protection | Switching system | Contact material | Contacts | Switching action | Terminals | □ 9 x 9 mm Typ-Nr. | ∅ 9 mm Typ-Nr. | Component layout | Mounting dimensions | Technical drawing | Circuit drawing | |
|--|------------------|------------------|------------------|----------|------------------|-----------|-----------------------|-------------------|------------------|---------------------|-------------------|-----------------|-------|
| Illuminated pushbutton actuator | IP 40 | LL | Au | 1 NC | MA | S2 | 19-482.035 | 19-472.035 | 2 | 1 | 2 | 2 | 0.002 |
| | | | | | M | S2 | 19-452.035 | 19-432.035 | 2 | 1 | 2 | 4 | 0.002 |
| | | | | 1 NO | MA | S2 | 19-481.035 | 19-471.035 | 2 | 1 | 2 | 3 | 0.002 |
| | | | | | M | S2 | 19-451.035 | 19-431.035 | 2 | 1 | 2 | 5 | 0.002 |
| | | SA | Au | 1 NO | MA | S2 | 19-289.035 | 19-279.035 | 2 | 1 | 2 | 3 | 0.002 |
| | | | | | M | S2 | 19-159.035 | 19-139.035 | 2 | 1 | 2 | 5 | 0.002 |
| | | | Ag | 1 NO | MA | S2 | 19-289.015 | 19-279.015 | 2 | 1 | 2 | 3 | 0.002 |
| | | | | | M | S2 | 19-159.015 | 19-139.015 | 2 | 1 | 2 | 5 | 0.002 |

Switching system: LL = Low level switching element, SA = Snap-action switching element

Contact material: Au = Gold, Ag = Silver

Contacts: NC = Normally closed, NO = Normally open

Switching action: MA = Maintained action, M = Momentary action

Terminals: S2 = Soldering terminal (also pluggable 2.0 x 0.5 mm)

Component layout from page 115, Mounting dimensions from page 115, Technical drawing from page 116, Circuit drawing from page 117

Front

Lens

| | Lens | ∅ 9 x 9 mm Typ-Nr. | ∅ 9 mm Typ-Nr. |  |
|---|--------------------------------------|-----------------------|-------------------|---|
| Lens illuminative, holder translucent | Plastic flush transparent blue | 19-951.6 | 19-931.6 | 0.001 |
| | Plastic flush transparent green | 19-951.5 | 19-931.5 | 0.001 |
| | Plastic flush transparent red | 19-951.2 | 19-931.2 | 0.001 |
| | Plastic flush transparent white | 19-951.9 | 19-931.9 | 0.001 |
| | Plastic flush transparent yellow | 19-951.4 | 19-931.4 | 0.001 |
| illuminative (not recommended for film insert), holder transparent | Plastic flush transparent blue | 19-952.6 | 19-932.6 | 0.001 |
| | Plastic flush transparent colourless | 19-952.7 | 19-932.7 | 0.001 |
| | Plastic flush transparent green | 19-952.5 | 19-932.5 | 0.001 |
| | Plastic flush transparent red | 19-952.2 | 19-932.2 | 0.001 |
| | Plastic flush transparent yellow | 19-952.4 | 19-932.4 | 0.001 |
| non-illuminative | Plastic flush opaque black | 19-951.0 | 19-931.0 | 0.001 |
| | Plastic flush opaque grey | 19-951.8 | 19-931.8 | 0.001 |



Blind plug

| | Blind plug | ∅ 9 x 9 mm Typ-Nr. | ∅ 9 mm Typ-Nr. | Mounting dimensions |  |
|-------------------|---------------|-----------------------|-------------------|---------------------|---|
| Blind plug | Plastic black | 19-948.0 | 19-949.0 | 1 | 0.001 |



Mounting dimensions from page 115

Backside

PCB plug-in base

| | Terminals | Typ-Nr. | Component layout | Technical drawing |  |
|---------------------------------------|-----------|---------------|------------------|-------------------|---|
| PCB plug-in base Pins axial | P | 19-940 | 3 | 4 | 0.001 |
| Pins bent at right-angles | P | 19-941 | 4 | 5 | 0.001 |

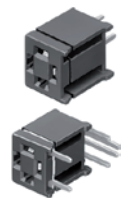

Terminals: P = PCB terminal

Component layout from page 115, Technical drawing from page 116

Flat receptacle

| | Typ-Nr. |  |
|--|---------------|---|
| Flat receptacle 2.0 x 0.5 mm | 31-945 | 0.001 |



Insulation sleeve

| | Typ-Nr. |  |
|--|---------------|---|
| Insulation sleeve for Flat receptacle 31-945 | 31-928 | 0.001 |



Illumination

Filament lamp

| | Socket | Operating voltage/-current | Typ-Nr. |  |
|--|-----------|----------------------------|---------------------|---|
| Filament lamp max. PIN length 5 mm | T1 Bi-Pin | 12 VAC/DC, 25 mA | 10-1609.1199 | 0.001 |
| | | 24 VAC/DC, 20 mA | 10-1612.1179 | 0.001 |
| | | 6 VAC/DC, 70 mA | 10-1606.1309 | 0.001 |



Single-LED

| | Socket | Light colour | Operating voltage/-current | Typ-Nr. |  |
|---|-----------|--------------|----------------------------|----------------------|---|
| Single-LED max. PIN length 8 mm | T1 Bi-Pin | green | 2.2 VDC, 20 mA | 10-2602.3175C | 0.001 |
| | | red | 2.2 VDC, 20 mA | 10-2602.3172C | 0.001 |
| | | white | 3.6 VDC, 20 mA | 10-2603.3179C | 0.001 |
| | | yellow | 2.2 VDC, 20 mA | 10-2602.3174C | 0.001 |



Multi-LED

| | Socket | Light colour | Operating voltage/-current | Typ-Nr. |  |
|--|-----------|--------------|----------------------------|----------------------|---|
| Multi-LED max. PIN length 5 mm | T1 Bi-Pin | green | 28 VDC, 12 mA | 10-4613.3105B | 0.001 |
| | | orange | 28 VDC, 12 mA | 10-4613.3103B | 0.001 |
| | | red | 28 VDC, 12 mA | 10-4613.3102B | 0.001 |
| | | yellow | 28 VDC, 12 mA | 10-4613.3104B | 0.001 |



Assembling

Fixing nut

| | Typ-Nr. |  |
|-------------------------------------|---------------|---|
| Fixing nut Ø 9/M8 x 13 mm | 19-991 | 0.001 |



Dressing tool

| | Typ-Nr. |  |
|--|---------------|---|
| Dressing tool for aligning buttons | 19-906 | 0.011 |



Lens remover

| | Typ-Nr. |  |
|---------------------|---------------|---|
| Lens remover | 19-910 | 0.002 |



Lamp remover

| | Typ-Nr. |  |
|---------------------|---------------|---|
| Lamp remover | 11-906 | 0.003 |



CAUTION
A switching process might be released when replacing the Lamp/LED !

Mounting tool

| | Typ-Nr. |  |
|--|---------------|---|
| Mounting tool for Fixing nut long 19-991 | 19-905 | 0.011 |



Actuator with snap-action switching element

Switching system

Single-break, snap-action switching system.
1 normally open contact

Material

Material of contact

Gold plated Silver, Silver plated

Switch housing

Polyetherimide (PEI), self-extinguishing

Actuator housing

Polyphenyleneoxide (PPO), self-extinguishing, colour black

Mechanical characteristics

Terminals

Universal terminal:
Max. wire diameter 2 x 0.8 mm
Max. wire cross-section of stranded cable 1 x 0.75 mm²

Plug-in terminal: 2.0 x 0.5 mm
For these terminals we can also supply a plug-in base which, when soldered on to the board, enables the switch to be plugged in.

Tightening torque

for fixing nut max. 20 Ncm

Actuating force

1.6 N

Actuating travel

2.8 mm ±0.2 mm

Mechanical lifetime

2 million operations

Electrical characteristics

Switch rating

Silver plated:
Max. 50 VAC / 72 VDC, 0.8 A or 50 W
Min. 20 V, 10 mA
Gold plated:
Max. 50 VAC / 72 VDC, 100 mA or 5 W
Min. 100 µV, 50 µA

Electric strength

2500 VAC, 50 Hz, 1 min. between all terminals and earth, as per IEC 60512-2-11

Environmental conditions

Storage temperature

-40 °C ... +85 °C

Service temperature

without illumination -25 °C ... +65 °C
with incandescent lamp -25 °C ... +45 °C
with LED -25 °C ... +65 °C
for indicators and illuminated pushbuttons mounted as a block, make sure the heat can escape freely

Protection degree

IP 40 front side, as per IEC 60529

Actuator with low level switching element

Switching system

This low-level switching system was designed for switching low powers in electronic circuits. The switching system assures reliable switching of loads.
Single-break momentary contact, as normally open or normally closed with 4 independent points of contact.
Special features are the long life, extremely short rebound time and stable contact resistance.
1 normally open or 1 normally closed contact.

Material

Material of contact

Gold plated

Actuator housing

Polyphenyleneoxide (PPO), self-extinguishing, colour black

Mechanical characteristics

Terminals

Universal terminal:
Max. wire diameter 2 x 0.8 mm
Max. wire cross-section of stranded cable 1 x 0.75 mm²

Plug-in terminal: 2.0 x 0.5 mm
For these terminals we can also supply a plug-in base which, when soldered on to the board, enables the switch to be plugged in.

Tightening torque

for fixing nut max. 20 Ncm

Actuating force

1.8 N ±0.3 N

Actuating travel

2.8 mm ±0.2 mm

Rebound time

Typ. <100 µs

Mechanical lifetime

5 million operations

Electrical characteristics

Contact resistance

≤50 mΩ starting value (initial) as per IEC 60512-2-2b

Switch rating

10 µA, 100 µV to 100 mA at 42 VAC/VDC

Electric strength

2500 VAC, 50 Hz, 1 min. between all terminals and earth, as per IEC 60512-2-11

Environmental conditions

Storage temperature

-40 °C ... +85 °C

Service temperature

without illumination -25 °C ... +65 °C
with incandescent lamp -25 °C ... +45 °C
with LED -25 °C ... +65 °C

for indicators and illuminated pushbuttons mounted as a block,
make sure the heat can escape freely

Protection degree

IP 40 front side, as per IEC 60529

Shock resistance

(Single impacts, semi-sinusoidal)

15 g for 11 ms, as per IEC 60512-4-3, IEC 60068-2-27

Component layout

1 Indicator actuator page 109

9 x 9 mm Ø9 mm



2 Illuminated pushbutton actuator page 109

9 x 9 mm Ø9 mm

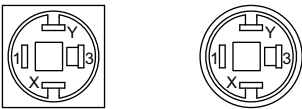

3 PCB plug-in base page 110

Drilling plan (element side)
Through-connection recommended

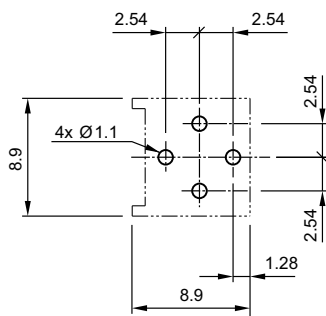

4 PCB plug-in base page 110

Drilling plan (element side)
Through-connection recommended

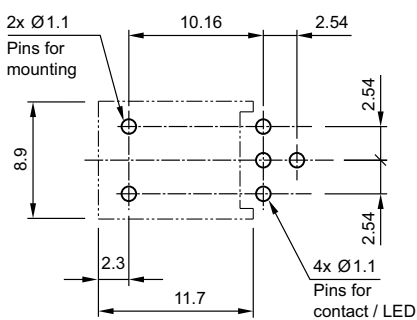

Mounting dimensions

1 Indicator actuator page 109 | Illuminated pushbutton actuator page 109 | Blind plug page 110

9 x 9 mm Ø9 mm

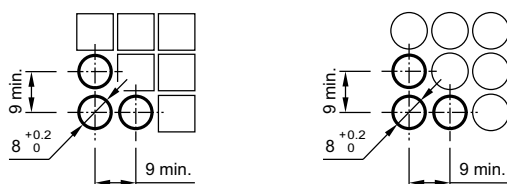

Technical drawing

1 Indicator actuator page 109

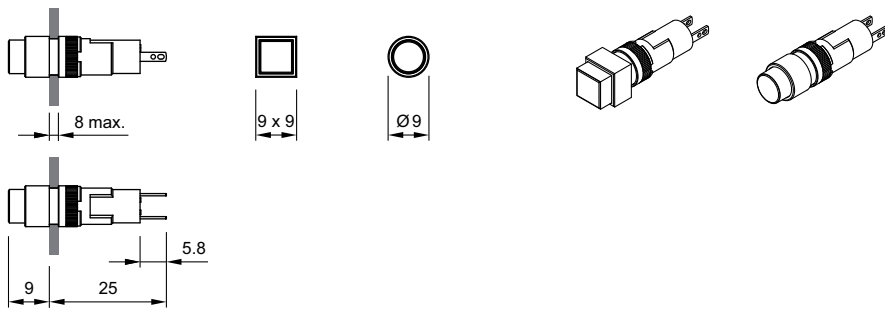

2 Illuminated pushbutton actuator page 109

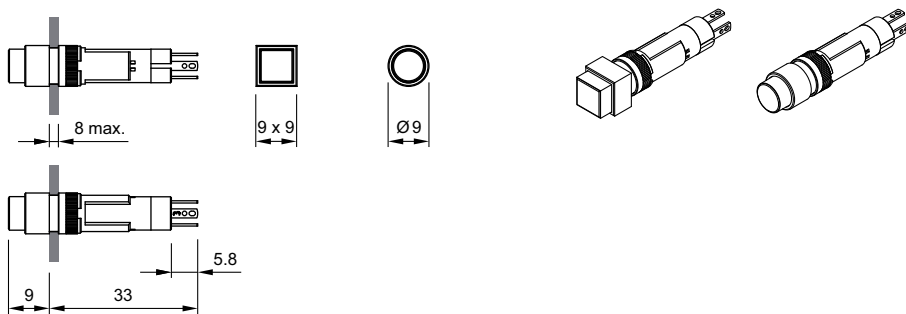

3 Indicator actuator page 109

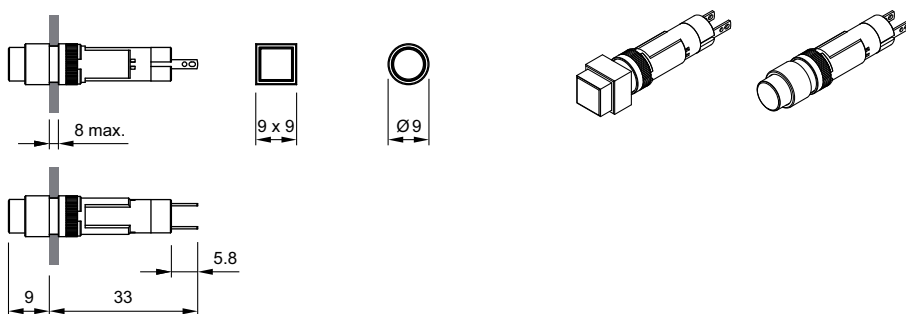

4 PCB plug-in base page 110

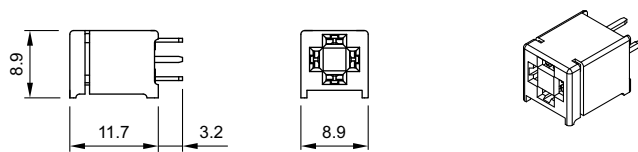

5 PCB plug-in base page 110

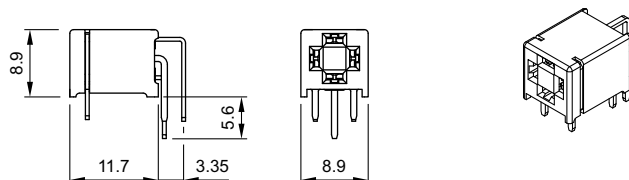

Circuit drawing

1 Indicator actuator page 109



2 Illuminated pushbutton actuator page 109

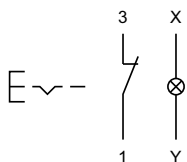

3 Illuminated pushbutton actuator page 109

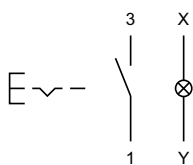

4 Illuminated pushbutton actuator page 109

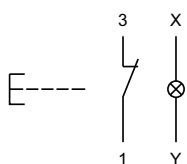

5 Illuminated pushbutton actuator page 109

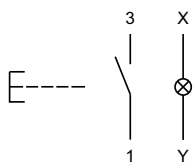



| | |
|--------------------------------------|------------|
| Description | 121 |
| Product Assembly | 122 |
| Mounting instruction | 124 |
| Devices raised mounting | 125 |
| Devices flush mounting | 127 |
| Accessories..... | 131 |
| Technical Data..... | 143 |
| Application guidelines..... | 146 |
| Drawings..... | 147 |
| Index..... | 159 |

Product Information

General notes

The Series 84 consists of indicators, pushbuttons and emergency-stop switches. The indicators and pushbuttons are a modular system of lens, actuator, switching element and a variety of means of connection and mounting. Different front protection of IP 67, IP 65 or IP 40 ensure that the pushbuttons are suited for industrial use.

Anodized aluminium parts can have visible variations due production-technical reasons.

Mounting

The actuators of the Series 84 are inserted in a 22.5 mm diameter mounting hole and the switching units are clipped on to the rear of the actuators. The pushbutton system can be mounted as a complete unit (actuator and switching unit). Mounting from the front with the wiring already attached is also possible.

When mounted on printed circuit boards the actuators are inserted in the mounting hole 22.5 mm dia. and the switching elements are fixed on the board. The printed circuit board is connected to the preassembled actuator by means of the mounting flange. There is no need for subsequent adjustment or spacing studs.

Lenses

The lenses are available in various colours and made either from plastic or anodized aluminium.

Marking

The marking plates of the Series 84 can be marked by engraving or hot stamping.

Specific symbols and markings are available on request.

The lenses are without holder not engravable, since by mounting no accurate position of the engraving text is reached.

Illumination

To ensure full illumination, the switching elements can be supplied with integrated single LEDs in the colours red, orange, yellow, green, blue or white. The series resistor is integrated.

Luminosity and wave length scattering caused by the technology used in the LED manufacturing processes may lead to visual differences in our products.

Emergency-stop pushbutton, foolproof

The E-stop pushbutton can be mounted in front panels with a thickness between 1 and 4 mm. It has a low behind-panel depth of 13.5 mm (max.) respectively 18.5 mm with plug-in terminlas and can be safely and easily adapted to PCBs of different heights. The front protection degree is IP 65.

Importantly, the Series 84 emergency-stop requires no additional assembly because of its single-piece 'monoblock' design.

The switch's status is clearly indicated by a black or green colour ring on the shaft, and the foolproof actuator design conforms to DIN EN ISO 13850 and EN IEC 60947.

It can be supplied with LED illumination that is visible even from the side.

Specimen order

Indicator :

- Indicator actuator, IP67 84-0100.0

Essential accessories :

- Lens plastic blue 84-7111.600

- Illumination element Single-LED blue 24VDC, plug-in terminal 84-8001.6620

or

Indicator with PCB terminal :

- Indicator actuator, IP67 84-3100.1

Essential accessories :

- Lens plastic red 84-7111.200

- Illumination element with PCB terminal 92-800.042

- Single-LED red 2.1VDC 10-2602.3202L

- Mounting flange 92-960.0

*We reserve the right to modify technical data
All dimensions in mm*

Indicator and pushbutton illuminative, 25 mm dia.

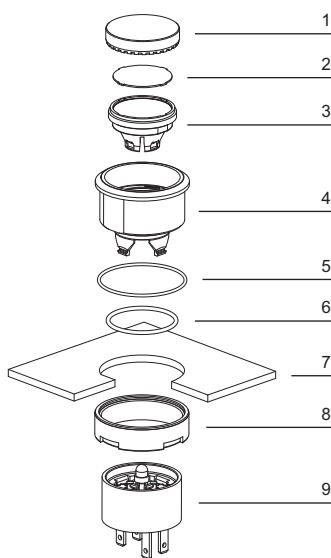

- 1 Lens
- 2 Marking plate
- 3 Lens holder
- 4 Actuator housing
- 5 Outer sealing
- 6 Inner sealing
- 7 Front panel
- 8 Fixing nut
- 9 Switching-/Illumination element with plug-in terminal (solderable)

Indicator and pushbutton illuminative, 40 mm dia.

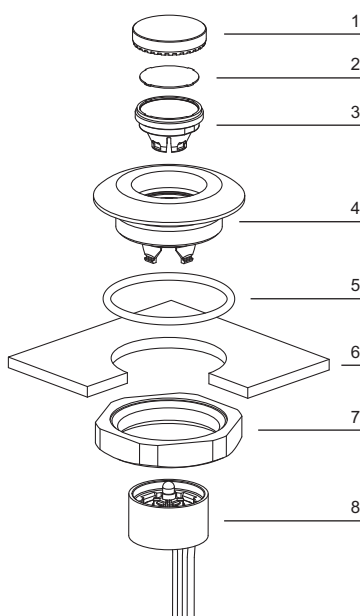

- 1 Lens
- 2 Marking plate
- 3 Lens holder
- 4 Actuator housing
- 5 Sealing
- 6 Front panel
- 7 Fixing nut
- 8 Switching-/Illumination element with flat ribbon cable

Indicator and pushbutton illuminative, 25 mm dia., PCB version

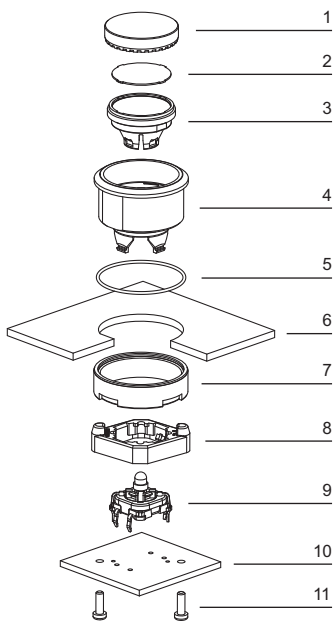

- 1 Lens
- 2 Marking plate
- 3 Lens holder
- 4 Actuator housing
- 5 Sealing
- 6 Front panel
- 7 Fixing nut
- 8 Mounting flange
- 9 Switching-/Illumination element with PCB terminal
- 10 PCB
- 11 Fixing screws

Emergency-stop pushbutton

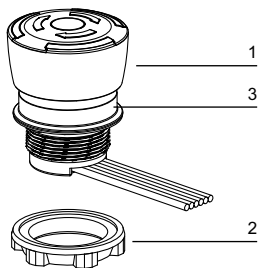

- 1 Emergency-stop pushbutton
- 2 Fixing nut
- 3 Position indication ring green or black

Arrangement mounting flange for switching- and illumination element, PCB mounting

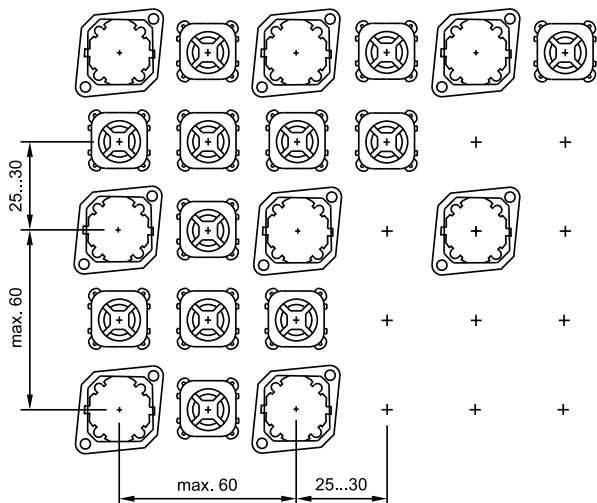

The arrangement of the mounting flanges and their number is determined by the size of the front panel or PCB. To ensure uniform, tactile switching, we recommend a layout of the flanges as per adjacent sketch.

For large PCBs with several switching elements we recommend the following procedure :

1. Fit the actuator to the front panel.
2. Clip the mounting flange to the rear of the intended actuator.
3. Screw the PCB with the components soldered to it to the assembled mounting flange.

This arrangement applies to PCBs 1.6 mm thick.

Dismantling mounting flange

The tool 84-998 must be used for removing the mounting flange from the actuator. Before removing the flange, the PCB fixing screws must be loosened.

Emergency-stop pushbutton, foolproof EN IEC 60947-5-5, complete

Application as per DIN EN ISO 13850 and EN 60204-1



| | Front protection | Switching action | Mushroom had cap | Illumination | Terminals | Contacts | Ø 32 mm Typ-Nr. | Component layout | Mounting dimensions | Technical drawing | Circuit drawing | |
|--|------------------|------------------|------------------|--------------|-----------|-------------|---------------------|------------------|---------------------|-------------------|-----------------|-------|
| Emergency-stop pushbutton, foolproof EN IEC 60947-5-5, complete Position indication ring black Twist to unlock clockwise | IP 65 | MA | Plastic red | without | FR | 1 NC | 84-5020.0040 | 2 | 2 | 17 | 8 | 0.036 |
| | | | | | | 1 NC + 1 NO | 84-5030.0040 | 2 | 2 | 17 | 9 | 0.036 |
| | | | | | | 2 NC | 84-5040.0040 | 2 | 2 | 17 | 10 | 0.036 |
| | | | | | PT 2.8 s | 1 NC | 84-5020.0020 | 1 | 2 | 17 | 8 | 0.028 |
| | | | | | | 1 NC + 1 NO | 84-5030.0020 | 1 | 2 | 17 | 9 | 0.028 |
| | | | | | | 2 NC | 84-5040.0020 | 1 | 2 | 17 | 10 | 0.028 |
| Position indication ring black Twist to unlock clockwise LED operating voltage: 5 ... 30 VDC Current consumption: 9.7 ... 12.4 mA | IP 65 | MA | Plastic red | LED red | FR | 1 NC | 84-5021.2B40 | 2 | 2 | 17 | 11 | 0.036 |
| | | | | | | 1 NC + 1 NO | 84-5031.2B40 | 2 | 2 | 17 | 12 | 0.036 |
| | | | | | | 2 NC | 84-5041.2B40 | 2 | 2 | 17 | 13 | 0.036 |
| | | | | | PT 2.8 s | 1 NC | 84-5021.2B20 | 1 | 2 | 17 | 11 | 0.028 |
| | | | | | | 1 NC + 1 NO | 84-5031.2B20 | 1 | 2 | 17 | 12 | 0.028 |
| | | | | | | 2 NC | 84-5041.2B20 | 1 | 2 | 17 | 13 | 0.028 |
| Position indication ring green Twist to unlock clockwise | IP 65 | MA | Plastic red | without | FR | 1 NC | 84-5120.0040 | 2 | 2 | 17 | 8 | 0.036 |
| | | | | | | 1 NC + 1 NO | 84-5130.0040 | 2 | 2 | 17 | 9 | 0.036 |
| | | | | | | 2 NC | 84-5140.0040 | 2 | 2 | 17 | 10 | 0.036 |
| | | | | | PT 2.8 s | 1 NC | 84-5120.0020 | 1 | 2 | 17 | 8 | 0.028 |
| | | | | | | 1 NC + 1 NO | 84-5130.0020 | 1 | 2 | 17 | 9 | 0.028 |
| | | | | | | 2 NC | 84-5140.0020 | 1 | 2 | 17 | 10 | 0.028 |
| Position indication ring green Twist to unlock clockwise LED operating voltage: 5 ... 30 VDC Current consumption: 9.7 ... 12.4 mA | IP 65 | MA | Plastic red | LED red | FR | 1 NC | 84-5121.2B40 | 2 | 2 | 17 | 11 | 0.036 |
| | | | | | | 1 NC + 1 NO | 84-5131.2B40 | 2 | 2 | 17 | 12 | 0.036 |
| | | | | | | 2 NC | 84-5141.2B40 | 2 | 2 | 17 | 13 | 0.036 |
| | | | | | PT 2.8 s | 1 NC | 84-5121.2B20 | 1 | 2 | 17 | 10 | 0.028 |
| | | | | | | 1 NC + 1 NO | 84-5131.2B20 | 1 | 2 | 17 | 12 | 0.028 |
| | | | | | | 2 NC | 84-5141.2B20 | 1 | 2 | 17 | 13 | 0.028 |

Standard version:

Flat ribbon-cable length 300 mm; Plug-in terminal 2.8 x 0.5 mm.

Other options on request:

Customisation of flat ribbon-cable and connectors.

Switching action: MA = Maintained action

Terminals: FR = Flat ribbon cable, PT 2.8 s = Plug-in terminal 2.8 mm (solderable)

Contacts: NC = Normally closed, NO = Normally open

Component layout from page 147, Mounting dimensions from page 150, Technical drawing from page 151, Circuit drawing from page 155

Stop pushbutton grey, complete



| | Front protection | Switching action | Mushroom had cap | Illumination | Terminals | Contacts | Ø 32 mm Typ-Nr. | Component layout | Mounting dimensions | Technical drawing | Circuit drawing | |
|--|------------------|------------------|------------------|--------------|-----------|-------------|---------------------|------------------|---------------------|-------------------|-----------------|-------|
| Stop pushbutton grey, complete Position indication ring black Twist to unlock clockwise | IP 65 | MA | Plastic grey | without | FR | 1 NC | 84-6020.0040 | 2 | 2 | 17 | 8 | 0.036 |
| | | | | | | 1 NC + 1 NO | 84-6030.0040 | 2 | 2 | 17 | 9 | 0.036 |
| | | | | | | 2 NC | 84-6040.0040 | 2 | 2 | 17 | 10 | 0.036 |
| | | | | | PT 2.8 s | 1 NC | 84-6020.0020 | 1 | 2 | 17 | 8 | 0.028 |
| | | | | | | 1 NC + 1 NO | 84-6030.0020 | 1 | 2 | 17 | 9 | 0.028 |
| | | | | | | 2 NC | 84-6040.0020 | 1 | 2 | 17 | 10 | 0.028 |
| Position indication ring black Twist to unlock clockwise LED operating voltage: 5 ... 30 VDC Current consumption: 9.7 ... 12.4 mA | IP 65 | MA | Plastic grey | LED red | FR | 1 NC | 84-6021.2B40 | 2 | 2 | 17 | 11 | 0.036 |
| | | | | | | 1 NC + 1 NO | 84-6031.2B40 | 2 | 2 | 17 | 12 | 0.036 |
| | | | | | | 2 NC | 84-6041.2B40 | 2 | 2 | 17 | 13 | 0.036 |
| | | | | | PT 2.8 s | 1 NC | 84-6021.2B20 | 1 | 2 | 17 | 11 | 0.028 |
| | | | | | | 1 NC + 1 NO | 84-6031.2B20 | 1 | 2 | 17 | 12 | 0.028 |
| | | | | | | 2 NC | 84-6041.2B20 | 1 | 2 | 17 | 13 | 0.028 |

Standard version:

Flat ribbon-cable length 300 mm; Plug-in terminal 2.8 x 0.5 mm.

Other options on request:

Customisation of flat ribbon-cable and connectors.

Switching action: MA = Maintained action

Terminals: FR = Flat ribbon cable, PT 2.8 s = Plug-in terminal 2.8 mm (solderable)

Contacts: NC = Normally closed, NO = Normally open



Component layout from page 147, Mounting dimensions from page 150, Technical drawing from page 151, Circuit drawing from page 155

Indicator actuator

Illuminated lens, non-illuminated bezel



Essential Accessories:

-  Illumination element page 135
-  Lens plastic page 131

| | Front protection | Front ring | Ø 25 mm Typ-Nr. | Mounting dimensions | | | Technical drawing |
|--------------------|------------------|-------------------|--------------------|---------------------|----|-------|---|
| Indicator actuator | IP 40 | Plastic black | 84-3100.0 | 1 | 16 | 0.004 |  |
| | IP 67 | Aluminium natural | 84-0200.7 | 1 | 16 | 0.008 | |
| | | Plastic black | 84-0100.0 | 1 | 16 | 0.003 | |



Mounting dimensions from page 150, Technical drawing from page 151

Illuminated pushbutton actuator

Illuminated lens, non-illuminated bezel



Essential Accessories:

-  Lens plastic page 131
-  Switching element illuminated page 137

| | Switching action | Front protection | Front ring | Ø 40 mm Typ-Nr. | Ø 25 mm Typ-Nr. | Mounting dimensions | | | Technical drawing | Circuit drawing |
|---------------------------------|------------------|------------------|-----------------------|--------------------|--------------------|---------------------|----|---|-------------------|---|
| Illuminated pushbutton actuator | M | IP 67 | Aluminium natural | 84-1221.7 | | 3 | 18 | 4 | 0.022 |  |
| | | IP 40 | Plastic black | | 84-2101.0 | 1 | 16 | 4 | 0.004 | |
| | | IP 67 | Aluminium black | | 84-1201.0 | 1 | 16 | 4 | 0.008 | |
| | | | Aluminium blue | | 84-1201.6 | 1 | 16 | 4 | 0.008 | |
| | | | Aluminium gold | | 84-1201.4 | 1 | 16 | 4 | 0.008 | |
| | | | Aluminium natural | | 84-1201.7 | 1 | 16 | 4 | 0.008 | |
| | | | Aluminium olive-green | | 84-1201.5 | 1 | 16 | 4 | 0.008 | |
| | | | Aluminium red | | 84-1201.2 | 1 | 16 | 4 | 0.008 | |
| | | | Plastic black | | 84-1101.0 | 1 | 16 | 4 | 0.003 | |

Switching action: M = Momentary action

Mounting dimensions from page 150, Technical drawing from page 151, Circuit drawing from page 155

Pushbutton actuator

Non-illuminated lens and bezel



Essential Accessories:

Lens metal page 132

Switching element non-illuminated page 138

| | Front protection | Switching action | Front ring | Ø 40 mm Typ-Nr. | Ø 25 mm Typ-Nr. | Mounting dimensions | | | |
|----------------------------|------------------|------------------|-----------------------|--------------------|--------------------|---------------------|-----------------|---|-------|
| | | | | | | Technical drawing | Circuit drawing | | |
| Pushbutton actuator | IP 67 | M | Aluminium natural | 84-1221.7 | | 3 | 18 | 4 | 0.022 |
| | IP 40 | M | Plastic black | | 84-2101.0 | 1 | 16 | 4 | 0.004 |
| | IP 67 | M | Aluminium black | | 84-1201.0 | 1 | 16 | 4 | 0.008 |
| | | | Aluminium blue | | 84-1201.6 | 1 | 16 | 4 | 0.008 |
| | | | Aluminium gold | | 84-1201.4 | 1 | 16 | 4 | 0.008 |
| | | | Aluminium natural | | 84-1201.7 | 1 | 16 | 4 | 0.008 |
| | | | Aluminium olive-green | | 84-1201.5 | 1 | 16 | 4 | 0.008 |
| | | | Aluminium red | | 84-1201.2 | 1 | 16 | 4 | 0.008 |
| | | | Plastic black | | 84-1101.0 | 1 | 16 | 4 | 0.003 |

Switching action: M = Momentary action

Mounting dimensions from page 150, Technical drawing from page 151, Circuit drawing from page 155

Indicator actuator with ring illumination (illuminated bezel)



Essential Accessories:

Illumination element page 135

Lens metal for Ring illumination page 132

| | Front protection | Front ring | Ø 25 mm Typ-Nr. | Mounting dimensions | Technical drawing | |
|--|------------------|---------------------|--------------------|---------------------|-------------------|-------|
| Indicator actuator with ring illumination (illuminated bezel) | IP 67 | Plastic translucent | 84-0090.7 | 1 | 16 | 0.006 |

Accessories for ring illumination:

Essential lenses Typ-Nr. 84-7202.x00A and 84-7205.x00A



Bi-colour illumination elements are not recommended.

Mounting dimensions from page 150, Technical drawing from page 151

Pushbutton actuator with ring illumination (illuminated bezel)



Essential Accessories:

-  Lens metal for Ring illumination page 132
-  Switching element illuminated page 137

| | Switching action | Front protection | Front ring | Ø 25 mm Typ-Nr. | Mounting dimensions | Technical drawing | Circuit drawing |  |
|---|------------------|------------------|---------------------|--------------------|---------------------|-------------------|-----------------|---|
| Pushbutton actuator with ring illumination (illuminated bezel) | M | IP 67 | Plastic translucent | 84-1091.7 | 1 | 16 | 4 | 0.006 |

Accessories for ring illumination:

Essential lenses Typ-Nr. 84-7202.x00A and 84-7205.x00A

Bi-colour switching elements are not recommended.





Switching action: M = Momentary action

Mounting dimensions from page 150, Technical drawing from page 151, Circuit drawing from page 155

Indicator actuator with ring illumination (illuminated multi-colour bezel)



Essential Accessories:

-  Illumination element PCB mounting page 139
-  Lens plastic page 131
-  Mounting flange page 139
-  Single-LED page 140





| | Front protection | Front ring | Ø 25 mm Typ-Nr. | Mounting dimensions | Technical drawing |  |
|---|------------------|---------------------|--------------------|---------------------|-------------------|---|
| Indicator actuator with ring illumination (illuminated multi-colour bezel) | IP 67 | Plastic transparent | 84-0080.7 | 1 | 16 | 0.006 |

Mounting dimensions from page 150, Technical drawing from page 151

Pushbutton actuator with ring illumination (illuminated multi-colour bezel)



Essential Accessories:

-  Lens plastic page 131
-  Mounting flange page 139
-  Single-LED page 140
-  Switching element PCB mounting illuminative page 139

| | Switching action | Front protection | | Ø 25 mm Typ-Nr. | Mounting dimensions | Technical drawing | Circuit drawing | |
|--|------------------|------------------|-----------------------------------|--------------------|---------------------|-------------------|-----------------|-------|
| Pushbutton actuator with ring illumination (illuminated multi-colour bezel) | M | IP 67 | Front ring Plastic transparent | 84-1081.7 | 1 | 16 | 4 | 0.006 |

Switching action: M = Momentary action

Mounting dimensions from page 150, Technical drawing from page 151, Circuit drawing from page 155

Front

Lens plastic

| | Mounting type | Lens | Ø 25 mm Typ-Nr. |  |
|--|--------------------|------------------------|--------------------|---|
| Lens plastic flush - level, illuminative | level with bezel | blue transparent | 84-7111.600 | 0.001 |
| | | colourless transparent | 84-7111.700 | 0.001 |
| | | green transparent | 84-7111.500 | 0.001 |
| | | orange transparent | 84-7111.300 | 0.001 |
| | | red transparent | 84-7111.200 | 0.001 |
| | | yellow transparent | 84-7111.400 | 0.001 |
| flush - level, non-illuminative | level with bezel | black opaque | 84-7121.000 | 0.001 |
| | level with bezel | grey opaque | 84-7121.800 | 0.001 |
| flush - raised, illuminative | raised above bezel | blue transparent | 84-7115.600 | 0.001 |
| | | colourless transparent | 84-7115.700 | 0.001 |
| | | green transparent | 84-7115.500 | 0.001 |
| | | orange transparent | 84-7115.300 | 0.001 |
| | | red transparent | 84-7115.200 | 0.001 |
| | | yellow transparent | 84-7115.400 | 0.001 |
| flush - raised, non-illuminative | raised above bezel | black opaque | 84-7125.000 | 0.001 |
| | | grey opaque | 84-7125.800 | 0.001 |



Marking plate for lens plastic

can be hot stamped

| | Marking plate | Typ-Nr. |  |
|---------------------------------------|--------------------------------|------------------|---|
| Marking plate for lens plastic | Plastic colourless transparent | 61-9707.7 | 0.001 |



Lens plastic with symbol

| | Mounting type | Symbol | Lens | Ø 25 mm Typ-Nr. |  |
|--|------------------|------------------------|------------------------|--------------------|---|
| Lens plastic with symbol flush - level, illuminative | level with bezel | ON/OFF | blue transparent | 84-7111.602 | 0.002 |
| | | | colourless transparent | 84-7111.702 | 0.002 |
| | | | green transparent | 84-7111.502 | 0.002 |
| | | | red transparent | 84-7111.202 | 0.002 |
| | | Ring | blue transparent | 84-7111.601 | 0.002 |
| | | | colourless transparent | 84-7111.701 | 0.002 |
| | | | green transparent | 84-7111.501 | 0.002 |
| | | | orange transparent | 84-7111.301 | 0.002 |
| | | | red transparent | 84-7111.201 | 0.002 |
| | | | yellow transparent | 84-7111.401 | 0.002 |
| | | | Stand by | blue transparent | 84-7111.603 |
| | | colourless transparent | | 84-7111.703 | 0.002 |
| | | green transparent | | 84-7111.503 | 0.002 |
| | | red transparent | | 84-7111.203 | 0.002 |



The silvery coat is being applied on the lens (screen print) with an additional protective lacquer.

Lens metal

| | Mounting type | Lens | Ø 25 mm Typ-Nr. |  |
|---|--------------------|-----------------------|--------------------|---|
| Lens metal convex - level, non-illuminative | level with bezel | Aluminium black | 84-7202.000 | 0.003 |
| | | Aluminium blue | 84-7202.600 | 0.003 |
| | | Aluminium gold | 84-7202.400 | 0.003 |
| | | Aluminium natural | 84-7202.800 | 0.003 |
| | | Aluminium olive-green | 84-7202.500 | 0.003 |
| | | Aluminium red | 84-7202.200 | 0.003 |
| flush - level, non-illuminative | level with bezel | Aluminium black | 84-7201.000 | 0.003 |
| | | Aluminium blue | 84-7201.600 | 0.003 |
| | | Aluminium gold | 84-7201.400 | 0.003 |
| | | Aluminium natural | 84-7201.800 | 0.003 |
| | | Aluminium olive-green | 84-7201.500 | 0.003 |
| | | Aluminium red | 84-7201.200 | 0.003 |
| flush - raised, non-illuminative | raised above bezel | Aluminium black | 84-7205.000 | 0.003 |
| | | Aluminium blue | 84-7205.600 | 0.003 |
| | | Aluminium gold | 84-7205.400 | 0.003 |
| | | Aluminium natural | 84-7205.800 | 0.003 |
| | | Aluminium olive-green | 84-7205.500 | 0.003 |
| | | Aluminium red | 84-7205.200 | 0.003 |



Lens metal for Ring illumination

| | Mounting type | Lens | Ø 25 mm Typ-Nr. |  |
|--|--------------------|-----------------------|---------------------|---|
| Lens metal for Ring illumination convex - raised, non-illuminative | raised above bezel | Aluminium black | 84-7202.000A | 0.004 |
| | | Aluminium blue | 84-7202.600A | 0.004 |
| | | Aluminium gold | 84-7202.400A | 0.004 |
| | | Aluminium natural | 84-7202.800A | 0.004 |
| | | Aluminium olive-green | 84-7202.500B | 0.004 |
| | | Aluminium red | 84-7202.200A | 0.004 |
| flush - raised, non-illuminative | raised above bezel | Aluminium black | 84-7205.000A | 0.003 |
| | | Aluminium blue | 84-7205.600A | 0.003 |
| | | Aluminium gold | 84-7205.400A | 0.003 |
| | | Aluminium natural | 84-7205.800A | 0.003 |
| | | Aluminium olive-green | 84-7205.500A | 0.003 |
| | | Aluminium red | 84-7205.200A | 0.003 |



Lens metal with spot

| | Mounting type | Lens | Ø 25 mm Typ-Nr. |  |
|--|--------------------|-----------------------|--------------------|---|
| Lens metal with spot flush - level, illuminative | level with bezel | Aluminium black | 84-7211.000 | 0.002 |
| | | Aluminium blue | 84-7211.600 | 0.002 |
| | | Aluminium gold | 84-7211.400 | 0.002 |
| | | Aluminium natural | 84-7211.800 | 0.002 |
| | | Aluminium olive-green | 84-7211.500 | 0.002 |
| | | Aluminium red | 84-7211.200 | 0.002 |
| flush - raised, illuminative | raised above bezel | Aluminium black | 84-7215.000 | 0.002 |
| | | Aluminium blue | 84-7215.600 | 0.002 |
| | | Aluminium gold | 84-7215.400 | 0.002 |
| | | Aluminium natural | 84-7215.800 | 0.002 |
| | | Aluminium olive-green | 84-7215.500 | 0.002 |
| | | Aluminium red | 84-7215.200 | 0.002 |



Mushroom-head cap

| | Mushroom had cap | Ø 32 mm Typ-Nr. |  |
|--------------------------|--------------------------|---------------------|--|
| Mushroom-head cap | Plastic black opaque | 84-7124.000A | 0.004 |
| | Plastic blue opaque | 84-7124.600A | 0.004 |
| | Plastic blue transparent | 84-7114.600A | 0.004 |
| | Plastic green opaque | 84-7124.500A | 0.004 |
| | Plastic red opaque | 84-7124.200A | 0.004 |
| | Plastic yellow opaque | 84-7124.400A | 0.004 |



Front protective cap

for flush - level lenses only for protection IP 68

| | Front protective cap | Typ-Nr. |  |
|-----------------------------|------------------------------|------------------|---|
| Front protective cap | Silicone natural transparent | 84-9103.7 | 0.001 |

ATTENTION

when using the front protection cover the external sealing in the actuator has to be removed !



Legend frame

for devices 25 mm dia.

| | Legend frame | Typ-Nr. | Technical drawing |  |
|---------------------|---------------------------------------|------------------|-------------------|---|
| Legend frame | 30 x 50 mm, adhesive, Aluminium black | 61-9980.0 | 7 | 0.001 |



Technical drawing from page 151

Legend plate insert

for Legend frame 61-9980.0

| | Typ-Nr. |  |
|---|------------------|---|
| Legend plate insert 14.5 x 23.5 mm, adhesive, Aluminium black | 704.968.1 | 0.001 |
| 14.5 x 23.5 mm, adhesive, Aluminium natural | 704.968.0 | 0.001 |



Blind plug

| | Blind plug | Typ-Nr. | Technical drawing |  |
|--|---------------|------------------|-------------------|---|
| Blind plug Size 25 mm dia., for mounting hole 22.5 mm dia. | Plastic black | 61-9453.0 | 8 | 0.006 |
| Size 36 mm dia., for mounting hole 30.5 mm dia. | Plastic black | 704.964.8 | 1 | 0.007 |



Technical drawing from page 151

Backside

Illumination element

| | Protection degree | Illumination | Operating voltage/-current | Terminals | Typ-Nr. | Circuit drawing |  | |
|---|-------------------|-------------------|----------------------------|---------------------|---------------------|---------------------|---|-------|
| Illumination element LED and built-in resistor included | IP 40 | Single-LED blue | 12 VDC, 10 mA | FR | 84-8001.6340 | 5 | 0.010 | |
| | | | | PT 2.8 s | 84-8001.6320 | 5 | 0.005 | |
| | | | 24 VDC, 10 mA | FR | 84-8001.6640 | 5 | 0.010 | |
| | | | | PT 2.8 s | 84-8001.6620 | 5 | 0.005 | |
| | | | Single-LED green | 12 VDC, 10 mA | FR | 84-8001.5340 | 5 | 0.010 |
| | | | | | PT 2.8 s | 84-8001.5320 | 5 | 0.005 |
| | | 24 VDC, 10 mA | | FR | 84-8001.5640 | 5 | 0.010 | |
| | | | PT 2.8 s | 84-8001.5620 | 5 | 0.005 | | |
| | | Single-LED orange | 12 VDC, 10 mA | FR | 84-8001.3340 | 5 | 0.010 | |
| | | | | PT 2.8 s | 84-8001.3320 | 5 | 0.005 | |
| | | | 24 VDC, 10 mA | FR | 84-8001.3640 | 5 | 0.010 | |
| | | | | PT 2.8 s | 84-8001.3620 | 5 | 0.005 | |
| | | Single-LED red | 12 VDC, 10 mA | FR | 84-8001.2340 | 5 | 0.010 | |
| | | | | PT 2.8 s | 84-8001.2320 | 5 | 0.005 | |
| | | | 24 VDC, 10 mA | FR | 84-8001.2640 | 5 | 0.010 | |
| | | PT 2.8 s | | 84-8001.2620 | 5 | 0.005 | | |
| | | Single-LED white | 12 VDC, 10 mA | FR | 84-8001.9340 | 5 | 0.010 | |
| | | | | PT 2.8 s | 84-8001.9320 | 5 | 0.005 | |
| | | | 24 VDC, 10 mA | FR | 84-8001.9640 | 5 | 0.010 | |
| | | PT 2.8 s | | 84-8001.9620 | 5 | 0.005 | | |
| | | Single-LED yellow | 12 VDC, 10 mA | FR | 84-8001.4340 | 5 | 0.010 | |
| | | | | PT 2.8 s | 84-8001.4320 | 5 | 0.005 | |
| | | | 24 VDC, 10 mA | FR | 84-8001.4640 | 5 | 0.010 | |
| | | PT 2.8 s | | 84-8001.4620 | 5 | 0.005 | | |



Standard version:

Cable length 300 mm with insulated ferrule; Plug-in terminal 2.8 x 0.8 mm.

Other options on request:

Customisation of cable and connectors; Rear side fully sealed (IP 67).

Protection degree (rear side):

IP 40, upgrade to IP 67 with plug typ-Nr. 84-900 possible; With applications where strong vibrations occur, the plugs may become loose.

Terminals: FR = Flat ribbon cable, PT 2.8 s = Plug-in terminal 2.8 mm (solderable)

Circuit drawing from page 155

Illumination element with Bi-colour illumination

| | Illumination | Operating voltage/ current | Protection degree | Terminals | Typ-Nr. | Circuit drawing |  |
|---|----------------------------|-------------------------------|-------------------|-----------|---------------------|-----------------|---|
| Illumination element with Bi-colour illumination LED and built-in resistor included | Bi-colour LED red/green | 24 VDC, 20 mA | IP 40 | PT 2.8 s | 84-8005.8620 | 1 | 0.005 |
| | | | IP 67 | FR | 84-8005.8640 | 2 | 0.011 |
| | Bi-colour LED yellow/green | 24 VDC, 20 mA | IP 40 | PT 2.8 s | 84-8005.7620 | 1 | 0.005 |
| | | | IP 67 | FR | 84-8005.7640 | 2 | 0.011 |



Standard version:

Cable length 300 mm with insulated ferrule; Plug-in terminal 2.8 x 0.8 mm.

Other options on request:

Customisation of cable and connectors; Rear side fully sealed (IP 67).

Best illumination level will be reached with Alu lens with window, Typ-Nr. 84-7215.x00 and 84-7211.x00.

Protection degree (rear side):

- Plug-in terminal IP 40, upgrade to IP 67 with plug typ-Nr. 84-900 possible. With applications where strong vibrations occur, the plugs may become loose.

- Cable connection IP 67, rear side fully sealed. The illumination element of the cable version cannot be disconnected from the actuator any longer.

Terminals: PT 2.8 s = Plug-in terminal 2.8 mm (solderable), FR = Flat ribbon cable

Circuit drawing from page 155

Switching element illuminated



| | Protection degree | Contacts | Illumination | Operating voltage/-current | Terminals | Typ-Nr. | Circuit drawing |  | |
|--|-------------------|----------|-------------------|----------------------------|---------------|---------------------|---------------------|---|-------|
| Switching element illuminated LED and built-in resistor included | IP 40 | 1 NO | Single-LED blue | 12 VDC, 10 mA | FR | 84-8511.6340 | 7 | 0.015 | |
| | | | | | PT 2.8 s | 84-8511.6320 | 7 | 0.006 | |
| | | | | 24 VDC, 10 mA | FR | 84-8511.6640 | 7 | 0.015 | |
| | | | | | PT 2.8 s | 84-8511.6620 | 7 | 0.006 | |
| | | | | Single-LED green | 12 VDC, 10 mA | FR | 84-8511.5340 | 7 | 0.015 |
| | | | | | | PT 2.8 s | 84-8511.5320 | 7 | 0.006 |
| | | | 24 VDC, 10 mA | | FR | 84-8511.5640 | 7 | 0.015 | |
| | | | | | PT 2.8 s | 84-8511.5620 | 7 | 0.006 | |
| | | | Single-LED orange | 12 VDC, 10 mA | FR | 84-8511.3340 | 7 | 0.015 | |
| | | | | | PT 2.8 s | 84-8511.3320 | 7 | 0.006 | |
| | | | | 24 VDC, 10 mA | FR | 84-8511.3640 | 7 | 0.015 | |
| | | | | | PT 2.8 s | 84-8511.3620 | 7 | 0.006 | |
| | | | Single-LED red | 12 VDC, 10 mA | FR | 84-8511.2340 | 7 | 0.015 | |
| | | | | | PT 2.8 s | 84-8511.2320 | 7 | 0.006 | |
| | | | | 24 VDC, 10 mA | FR | 84-8511.2640 | 7 | 0.015 | |
| | | | | | PT 2.8 s | 84-8511.2620 | 7 | 0.006 | |
| | | | Single-LED white | 12 VDC, 10 mA | FR | 84-8511.9340 | 7 | 0.015 | |
| | | | | | PT 2.8 s | 84-8511.9320 | 7 | 0.006 | |
| | | | | 24 VDC, 10 mA | FR | 84-8511.9640 | 7 | 0.015 | |
| | | | | | PT 2.8 s | 84-8511.9620 | 7 | 0.006 | |
| | | | Single-LED yellow | 12 VDC, 10 mA | FR | 84-8511.4340 | 7 | 0.015 | |
| | | | | | PT 2.8 s | 84-8511.4320 | 7 | 0.006 | |
| | | | | 24 VDC, 10 mA | FR | 84-8511.4640 | 7 | 0.015 | |
| | | | | | PT 2.8 s | 84-8511.4620 | 7 | 0.006 | |

Standard version:

Cable length 300 mm with insulated ferrule; Plug-in terminal 2.8 x 0.8 mm.

Other options on request:

Customisation of cable and connectors; Rear side fully sealed (IP 67).

Protection degree (rear side):

IP 40, upgrade to IP 67 with plug typ-Nr. 84-900 possible; With applications where strong vibrations occur, the plugs may become loose.

Contacts: NO = Normally open

Terminals: FR = Flat ribbon cable, PT 2.8 s = Plug-in terminal 2.8 mm (solderable)

Circuit drawing from page 155

Switching element with Bi-colour illumination

| | Protection degree | Contacts | Illumination | Operating voltage/-current | Terminals | Typ-Nr. | Circuit drawing |  |
|--|-------------------|----------|----------------------------|----------------------------|-----------|---------------------|-----------------|---|
| Switching element with Bi-colour illumination LED and built-in resistor included | IP 67 | 1 NO | Bi-colour LED red/green | 24 VDC, 20 mA | FR | 84-8515.8640 | 3 | 0.015 |
| | | | Bi-colour LED yellow/green | 24 VDC, 20 mA | FR | 84-8515.7640 | 3 | 0.015 |



Protection degree IP 67, rear side fully sealed. The switching element cannot be disconnected from the actuator any longer.

Best illumination level will be reached with Alu lens with window, Typ-Nr. 84-7215.x00 and 84-7211.x00.

Standard version:

Cable length 300 mm with insulated ferrule.

Other options on request:

Customisation of cable and connectors.

Contacts: NO = Normally open

Terminals: FR = Flat ribbon cable

Circuit drawing from page 155

Switching element non-illuminated

| | Protection degree | Contacts | Terminals | Typ-Nr. | Circuit drawing |  |
|--|-------------------|----------|-----------|---------------------|-----------------|---|
| Switching element non-illuminated | IP 40 | 1 NO | FR | 84-8510.0040 | 6 | 0.010 |
| | | | PT 2.8 s | 84-8510.0020 | 6 | 0.005 |



Standard version:

Cable length 300 mm with insulated ferrule; Plug-in terminal 2.8 x 0.8 mm (solderable).

Other options on request:

Customisation of cable and connectors; Rear side fully sealed (IP 67).

Protection degree (rear side):

IP 40, upgrade to IP 67 with plug typ-Nr. 84-900 possible; With applications where strong vibrations occur, the plugs may become loose.

Contacts: NO = Normally open

Terminals: FR = Flat ribbon cable, PT 2.8 s = Plug-in terminal 2.8 mm (solderable)

Circuit drawing from page 155

Switching element PCB mounting illuminative

The customer has to decide what series resistor shall be used to the LED

| | Contacts | Terminals | Typ-Nr. | Component layout | Technical drawing | Circuit drawing |  |
|--|----------|-----------|-------------------|------------------|-------------------|-----------------|---|
| Switching element PCB mounting illuminative | 1 NO | P | 92-851.342 | 4 | 15 | 14 | 0.001 |



Illumination and mounting flange to be ordered separately.

Contacts: NO = Normally open

Terminals: P = PCB terminal

Component layout from page 147, Technical drawing from page 151, Circuit drawing from page 155

Illumination element PCB mounting

The customer has to decide what series resistor shall be used to the LED

| | Terminals | Typ-Nr. | Component layout | Technical drawing |  |
|--|-----------|-------------------|------------------|-------------------|--|
| Illumination element PCB mounting | P | 92-800.042 | 3 | 9 | 0.001 |



Illumination and mounting flange to be ordered separately.

Terminals: P = PCB terminal

Component layout from page 147, Technical drawing from page 151

Mounting flange

| | Typ-Nr. | Technical drawing |  |
|---|-----------------|-------------------|---|
| Mounting flange Ring illumination (illuminated multi-color bezel) | 84-960.0 | 13 | 0.001 |
| Standard version (non-illuminated) | 92-960.0 | 10 | 0.001 |



Technical drawing from page 151

Flat receptacle

| | Typ-Nr. |  |
|--|----------------|---|
| Flat receptacle 2.8 x 0.8 mm | 84-9420 | 0.001 |



Insulation sleeve

| | Typ-Nr. |  |
|--|---------------|---|
| Insulation sleeve for Flat receptacles 84-9420 | 31-929 | 0.001 |



Plug

| | Typ-Nr. |  |
|-------------|---------------|---|
| Plug | 84-900 | 0.001 |



for back protection IP67 of switching elements and illumination elements.
Two plugs are necessary per element.

Illumination

Single-LED

The customer has to decide what series resistor shall be used to the LED

| | Socket | Light colour | Operating voltage/-current | Typ-Nr. |  |
|-------------------|-----------|--------------|----------------------------|----------------------|--|
| Single-LED | T1 Bi-Pin | blue | 3.5 VDC, 20 mA | 10-2602.3206L | 0.001 |
| | | green | 3.5 VDC, 20 mA | 10-2602.3205L | 0.001 |
| | | orange | 2.1 VDC, 20 mA | 10-2602.3203L | 0.001 |
| | | red | 2.1 VDC, 20 mA | 10-2602.3202L | 0.001 |
| | | white | 3.5 VDC, 20 mA | 10-2602.3209L | 0.001 |
| | | yellow | 2.2 VDC, 20 mA | 10-2602.3174D | 0.001 |



Bi-colour LED

The customer has to decide what series resistor shall be used to the LED

| | Socket | Light colour | Operating voltage/-current | Typ-Nr. |  |
|----------------------|-----------|--------------|----------------------------|----------------------|---|
| Bi-colour LED | T1 Bi-Pin | red/green | 1.9/3.5 VDC, 20 mA | 10-2603.320AL | 0.001 |
| | | yellow/green | 2.0/3.2 VDC, 20 mA | 10-2603.320CL | 0.001 |



Multi-LED

The customer has to decide what series resistor shall be used to the LED

| | Socket | Light colour | Operating voltage/-current | Typ-Nr. |  |
|------------------|-----------|--------------|----------------------------|----------------------|---|
| Multi-LED | T1 Bi-Pin | yellow | 12 VDC, 40 mA | 10-5609.3174D | 0.001 |



Emergency-stop and Stop pushbutton

Emergency-stop label

front panel thickness 3 mm max.

| | Marking | Typ-Nr. |  |
|--|-----------------|------------------|---|
| Emergency-stop label 60 mm dia., yellow, Mounting hole size 22.5 mm dia. | ARRET D'URGENCE | 704.963.7 | 0.011 |
| | EMERGENCY STOP | 704.963.6 | 0.011 |
| | NOT AUS | 704.963.5 | 0.011 |
| | NOT HALT | 704.963.8 | 0.011 |
| 90 mm dia., yellow, Mounting hole size 22.5 mm dia. | ARRET D'URGENCE | 704.963.2 | 0.011 |
| | EMERGENCY STOP | 704.963.1 | 0.011 |
| | NOT AUS | 704.963.0 | 0.011 |
| | NOT HALT | 704.963.3 | 0.011 |



Emergency-stop protective shroud

Front panel thickness 1 ... 3 mm

| | Protective shroud | Marking | Typ-Nr. | Technical drawing |  |
|--|-----------------------|----------------|----------------|-------------------|---|
| Emergency-stop protective shroud 45 mm dia., IP 40, mounting hole 22.5 mm dia., with anti-twist device | Metal yellow RAL 1004 | without | 84-909 | 12 | 0.021 |
| 50 mm dia., IP 65, mounting hole 22.5 mm dia., with anti-twist device | Plastic yellow | EMERGENCY STOP | 84-902B | 14 | 0.006 |
| | | NOT - AUS | 84-902A | 14 | 0.006 |
| | | NOT - HALT | 84-902D | 14 | 0.006 |
| | | without | 84-902 | 14 | 0.006 |



Please note: By using the protective shroud Typ-Nr. 84-909 the E-stop or Stop-Switch has to be mounted twisted by 180°. Consult the dimensional drawing therefore.
Technical drawing from page 151

Fixing nut

| | Fixing nut | Typ-Nr. |  |
|---|---------------|---------------|---|
| Fixing nut 28 mm dia., for limited-space applications | Plastic black | 84-905 | 0.002 |
| 30 mm dia., standard delivery | Plastic black | 84-908 | 0.002 |



Flat receptacle

| | Typ-Nr. |  |
|---|---------------|---|
| Flat receptacle 2.8 x 0.5 mm for Plug-in terminal | 31-946 | 0.001 |



Insulation sleeve

| | Typ-Nr. |  |
|---|---------------|---|
| Insulation sleeve for Flat receptacles 31-946 | 31-929 | 0.001 |



Assembling

Lens remover

| | Typ-Nr. |  |
|---------------------|------------------|---|
| Lens remover | 61-9730.0 | 0.011 |



Mounting tool

| | Typ-Nr. |  |
|--|---------------|---|
| Mounting tool for tightening or loosening of Emergency-stop and Stop-Switch fixing nut | 84-996 | 0.014 |
| for tightening or loosening of Fixing nut, Indicator and Pushbutton | 84-997 | 0.027 |



Dismantling tool

| | Typ-Nr. |  |
|--|---------------|---|
| Dismantling tool for actuator dismantling of switching- and illumination element and mounting flange | 84-998 | 0.002 |



Emergency-stop

Switching system

The double-break switching system can be supplied for the following switching functions:

1 Normally closed, 2 Normally closed, 1 Normally closed + 1 Normally open.

The Normally closed contacts have forced opening according to EN IEC 60947-5-1

Material

Connection cable

Polyvinylchloride (PVC), operating temperature up to +65 °C

Mushroom-head cap

Polybutylenterephthalate (PBT), as per UL 94 V0 (red items)

Actuator housing

Polyamide (PA 66), as per UL 94 V0, Flat ribbon cable-cover
Polyamide (PA 6.6), as per UL 94 V0

Material of contact

Silver alloy gold plated

Mechanical characteristics

Front panel thickness

Standard 1 ... 4 mm
with E-stop protective shroud Typ-Nr. 84-902 1 ... 3 mm

Mounting hole

22.5 mm dia. as per EN IEC 60947-5-1 with anti-twist device

Terminals

Soldering terminals 2.8 x 0.5 mm (solderable), CuSn6 tin-plated
Flat ribbon cable 2-, 4-, or 6-poles 0.35 mm² (AWG 22)

Tightening torque

Fixing nut 80 Ncm

Actuating force

22 N ±4 N

Actuating travel

approx. 4 mm to release the internal operation part

Mechanical lifetime

≥50.000 cycles of operations

Electrical characteristics

Standards

The devices comply with : EN IEC 60947-5-1, EN IEC 60947-5-5 (Emergency-stop), DIN EN ISO 13850, EN IEC 60204

Illumination

LED red with pole reversal, constant current source

Operation Voltage 5 VDC ... 30 VDC
Current consumption 9.7 mA ... 12.4 mA

Rated Operational Voltage U_e

250 VAC, as per EN IEC 60947-1

Rated Insulation Voltage U_i

250 V, as per EN IEC 60947-1

Rated Impulse Withstand Voltage U_{imp}

2.5 kV, as per EN IEC 60947-1

Contact resistance

New state ≤ 50 mΩ, as per DIN IEC 60512-2-3

Isolation resistance

>10¹¹ Ω between the open contacts at 500 VDC, as per DIN IEC 60512-2-10

Electrical life

≥50 000 cycles of operations (inductive cosφ 0.4), as per EN IEC 60947-5-1

| | | | | |
|---------|---------|---------|---------|---------|
| Voltage | 120 VAC | 240 VAC | 125 VDC | 250 VDC |
| Current | 3 A | 1.5 A | 0.55 A | 0.27 A |

Reduced load ≥50'000 cycles of operations (resistive)

| | | |
|---------|----------|-----------|
| Voltage | 1 VAC/DC | 42 VAC/DC |
| Current | 100 mA | 200 mA |

Conventional free air thermal current I_{th}

5 A, as per EN IEC 60947-5-1
the maximum current in continuous operation and at ambient temperature must not exceed the quoted maximum values.

Switch rating

Switch rating AC with silver contact (gold plated), service category AC-15, as per EN IEC 60947-5-1

| | | |
|---------|---------|---------|
| Voltage | 120 VAC | 240 VAC |
| Current | 3 A | 1.5 A |

Switch rating DC for silver contact (gold plated), service category DC-13, as per EN IEC 60947-5-1 (inductive)

| | | | | | | |
|---------------|--------|--------|--------|--------|---------|---------|
| Voltage | 12 VDC | 24 VDC | 48 VDC | 60 VDC | 125 VDC | 250 VDC |
| Current Plug | 5 A | 4 A | 2.1 A | 1.7 A | 0.55 A | 0.27 A |
| Current Cable | 3 A | 3 A | 2.1 A | 1.7 A | 0.55 A | 0.27 A |

Recommended minimum operational data

Silver contacts (gold plated)

| | |
|---------|----------|
| Voltage | 1 VAC/DC |
| Current | 1 mA |

Electric strength

500 VAC, 50 Hz, 1 min, as per DIN IEC 60512-2

Rated conditional short-circuit current

1000 A, type of short-circuit unit 6 A gG, as per EN IEC 60947-5-1

Protection class

Class II, as per EN IEC 60947-5

Overvoltage category

II, as per EN IEC 60947-1

Degree of pollution

3, as per EN IEC 60947-1

Environmental conditions

Storage temperature

-25 °C ... +80 °C

Operating temperature

-25 °C ... +65 °C

Front protection

IP 65, as per EN IEC 60529

Shock resistance

(semi-sinusoidal)
max. 150 m/s², pulse width 11 ms, 3-axis, as per EN IEC 60068-2-27

Vibration resistance

(sinusoidal)
max. 50 m/s² at 10 Hz ... 500 Hz, 10 cycles, 3-axis, as per EN IEC 60068-2-6

Climate resistance

Damp heat, cyclic
96 hours, +25 °C / 97 %, +55 °C / 93 % relative humidity, as per EN IEC 60068-2-30

Damp heat, steady
56 days, +40 °C / 93 % relative humidity, as per EN IEC 60068-2-78

Dry heat
96 hours, +70 °C, as per EN IEC 60068-2-2

Low temperature
96 hours, -40 °C, as per EN IEC 60068-2-1

Saline mist
96 Stunden, +35 °C in chemical solution NaCl, as per EN IEC 60068-2-11

Approvals

Approbations

SEV
UL

Declaration of conformity

CE

Switching element illuminated pushbutton

Switching system

Short-travel switching system with 2 independent contact points and tactile operation.
Guarantees reliable switching even of very light loads.
Fitted with 1 normally open contact.

Material

Connection cable

Polyvinylchloride (PVC), short-time heat-resistant up to 105 °C

Material of contact

Silver alloy gold plated

Switching element

Thermoplastic polyester (PET, PBT), as per UL 94 V0 and Polyacetale (POM), as per UL 94 HB

Mechanical characteristics

Terminals

Plug-in terminals 2.8 x 0.8 mm (solderable)
Flat ribbon cable 0.5 mm²
PCB terminal

Actuating force

4.0 N ±0.2 N (measured at the lens)

Actuating travel

~0.5 mm

Rebound time

≤1 ms

Resistance to heat of soldering

260 °C, 5 s (PCB assembly)
350 °C, 10 s (when using a soldering iron)
as per EN IEC 60068-2-20

Mechanical lifetime

≥1 million cycles of operations

Electrical characteristics

Illumination

Single-Chip or Multi-Chip LED, green, orange, red, yellow, white and blue

Operation Voltage 12 VDC 24 VDC

Current consumption 40 mA 20 mA

Contact resistance

Starting value (initial) ≤100 mΩ, as per DIN IEC 60512-2

Isolation resistance

≥1 G Ω between all terminals at 100 VDC, as per DIN IEC 60512-2

Electrical life

as per EN IEC 60512-5

| | | |
|-----------|---------------------|------------------------------|
| 5 million | cycles of operation | 24 VAC, 50 mA at 480 Ω |
| 5 million | cycles of operation | 24 VAC, 100 mA at 240 Ω |
| 2 million | cycles of operation | 42 VAC, 50 mA at 840 Ω |
| 2 million | cycles of operation | 42 VAC, 100 mA at 420 Ω |
| 300 000 | cycles of operation | 42 VAC, 100 mA at cosφ 0,4 |
| 250 000 | cycles of operation | 42 VAC, 200 mA at cosφ 0,395 |

| | | |
|-------------|---------------------|-------------------------|
| 1 million | cycles of operation | 12 VDC, 250 mA at 48 Ω |
| 1 million | cycles of operation | 24 VDC, 50 mA at 480 Ω |
| 1 million | cycles of operation | 24 VDC, 100 mA at 240 Ω |
| 5 million | cycles of operation | 42 VDC, 25 mA at 1680 Ω |
| 1.5 million | cycles of operation | 42 VDC, 50 mA at 840 Ω |
| 100 000 | cycles of operation | 42 VDC, 100 mA at 420 Ω |

| | | |
|---------|---------------------|-----------------------------|
| 500 000 | cycles of operation | 24 VDC, 200 mA at L/R=30 ms |
| 300 000 | cycles of operation | 42 VDC, 100 mA at L/R=30 ms |
| 100 000 | cycles of operation | 42 VDC, 200 mA at L/R=30 ms |

Switch rating

Voltage 50 mVAC/DC ... 42 VAC/DC

Current 10 uA ... 100 mA

Power max. 2 W

Electric strength

500 VAC, 50 Hz, 1 min, as per DIN IEC 60512-2

Environmental conditions

Storage temperature

-40 °C ... +85 °C

Operating temperature

-25 °C ... +70 °C

Protection degree

Back protection:

IP 40, standard version

IP 67, fully sealed version, with mounted actuator only.

Shock resistance

(semi-sinusoidal)

max. 100 m/s², pulse width 11 ms, 3-axis, as per EN IEC 60068-2-27

Vibration resistance

(sinusoidal)

max. 50 m/s² at 10 Hz ... 500 Hz, 10 cycles, 3-axis, as per EN IEC 60068-2-6

Actuator

Material

Lens

Polycarbonate (PC), as per UL 94 V2 or Aluminium anodised

Actuator housing

Polyetherimid (PEI), as per UL 94 V0 or Aluminium anodised

Mechanical characteristics

Mounting hole

22.5 mm dia. and 30.5 mm dia.

Tightening torque

Fixing nut max. 80 Ncm

Actuating force

4.0 N ±0.2 N (measured at the lens)

Actuating travel

Total switching travel 1.2 mm

Mechanical lifetime

≥1 million cycles of operations

Electrical characteristics

Electrostatic breakdown value

Plastic case ≥15 kV

Aluminium case ≥5 kV

as per IEC 61000-4-2, mounted in plastic front panel

Environmental conditions

Storage temperature

-40 °C ... +85 °C

Operating temperature

-25 °C ... +70 °C

Front protection

IP 67, IP 65 and IP40, as per EN IEC 60529

Climate resistance

Damp heat, cyclic

96 hours, +25 °C / 97 %, +55 °C / 93 % relative humidity, as per EN IEC 60068-2-30

Damp heat, state

56 days, +40 °C / 93 % relative humidity, as per EN IEC 60068-2-78

Rapid change of temperature

100 cycles, -40 °C ... +80 °C, as per EN IEC 60068-2-14

Suppressor circuits

When switching inductive loads such as relays, DC motors, and DC solenoids, it is always important to absorb surges (e.g. with a diode) to protect the contacts. When these inductive loads are switched off, a counter emf can severely damage switch contacts and greatly shorten lifetime.

Fig. 1 shows an inductive load with a free-wheeling diode connected in parallel. This free-wheeling diode provides a path for the inductor current to flow when the current is interrupted by the switch. Without this free-wheeling diode, the voltage across the coil will be limited only by dielectric breakdown voltages of the circuit or parasitic elements of the coil. This voltage can be kilovolts in amplitude even when nominal circuit voltages are low (e.g. 12 VDC) see Fig. 2.

The free-wheeling diode should be chosen so that the reverse breakdown voltage is greater than the voltage driving the inductive load. The DC blocking voltage (VR) of the free-wheeling diode can be found in the datasheet of a diode. The forward current should be equal or greater than the maximum current flowing through the load.

To get an efficient protection, the free-wheeling diode must be connected as close as possible to the inductive load!

Switching with inductive load

Fig. 1

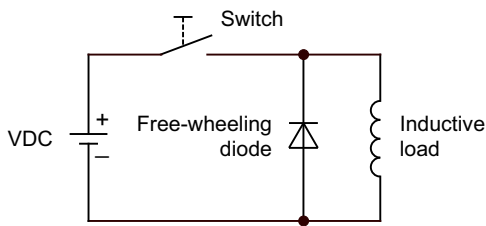

Counter emf over load without free-wheeling diode

Fig. 2

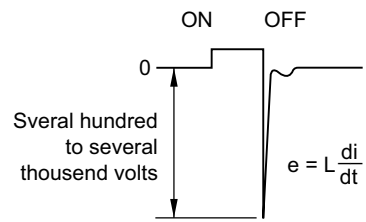

Component layout

1 Emergency-stop pushbutton, foolproof EN IEC 60947-5-5, complete page 125 | Stop pushbutton grey, complete page 126

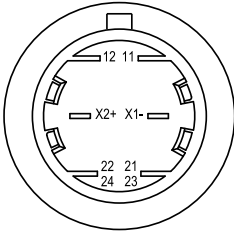

2 Emergency-stop pushbutton, foolproof EN IEC 60947-5-5, complete page 125 | Stop pushbutton grey, complete page 126

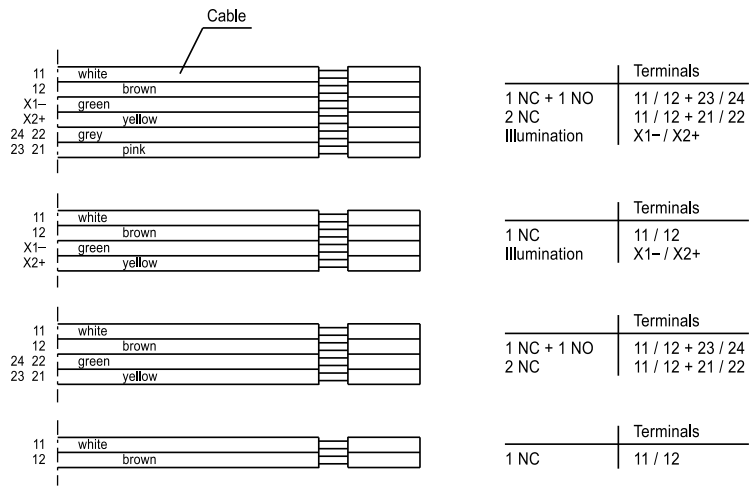
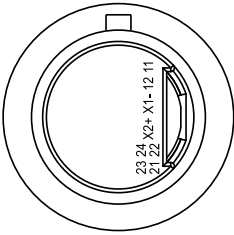

3 Illumination element PCB mounting page 139

Single-LED

Drilling plan (Elementside)

- A Fixing holes for mounting flange (92-960.0)
- B Holes for LED
- C Holes for centering pins

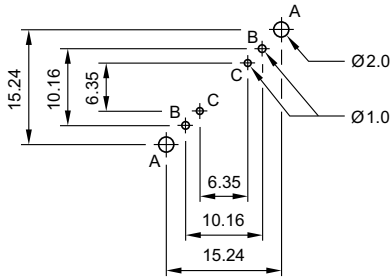

Bi-colour-LED

Drilling plan (Elementside)

- A Fixing holes for mounting flange (92-960.0)
- B Holes for Bi-colour LED:
BA1 (green) + BA2 (yellow or red) = Anodes, BC = Cathode
- C Holes for centering pins

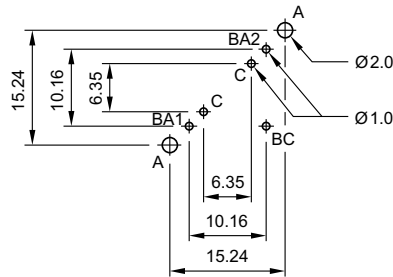

Hyper mini SMD-LED

Drilling plan (Elementside)

- A Fixing holes for mounting flange (84-960.0)

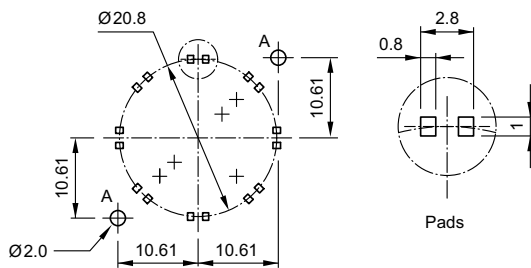

Libraries for the PCB layout-system p-cad 200X see : www.pcad.com/en/library Third-party Libraries

4 Switching element PCB mounting illuminative page 139

Single-LED

Drilling plan (Elementside)

- A Fixing holes for mounting flange (92-960.0)
- B Holes for LED
- C Holes for contact pins
Pad max. Ø 2.5 mm
Through-connection recommended

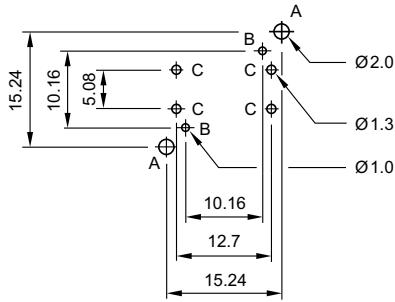

Bi-colour-LED

Drilling plan (Elementside)

- A Fixing holes for mounting flange (92-960.0)
- B Holes for Bi-colour LED:
BA1 (green) + BA2 (yellow or red) = Anodes, BK = Cathode
- C Holes for contact pins
Pad max. Ø 2.5 mm
Through-connection recommended

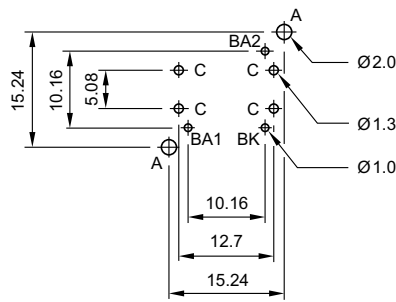

Hyper mini SMD-LED

Drilling plan (Elementside)

- A Fixing holes for mounting flange (84-960.0)

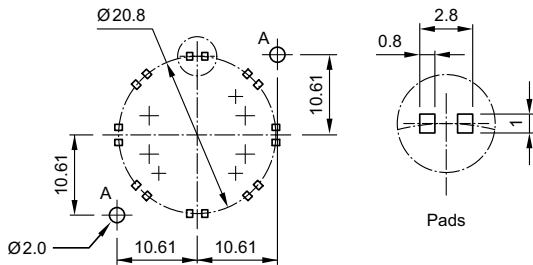

Libraries for the PCB layout-system p-cad 200X see : www.pcad.com/en/library Third-party Libraries

Mounting dimensions

1 Indicator actuator page 127 | Illuminated pushbutton actuator page 127 | Pushbutton actuator page 128 | Indicator actuator with ring illumination (illuminated bezel) page 128 | Pushbutton actuator with ring illumination (illuminated bezel) page 129 | Indicator actuator with ring illumination (illuminated multi-colour bezel) page 129 | Pushbutton actuator with ring illumination (illuminated multi-colour bezel) page 130

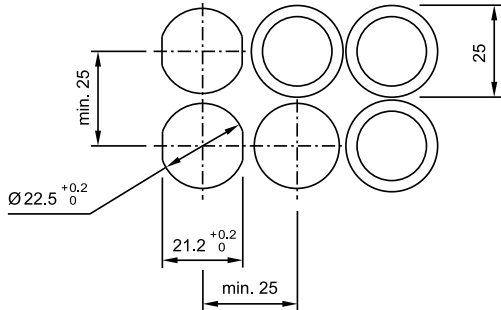

Hole spacing 31 mm min. by using blind plug 704.960.4

2 Emergency-stop pushbutton, foolproof EN IEC 60947-5-5, complete page 125 | Stop pushbutton grey, complete page 126

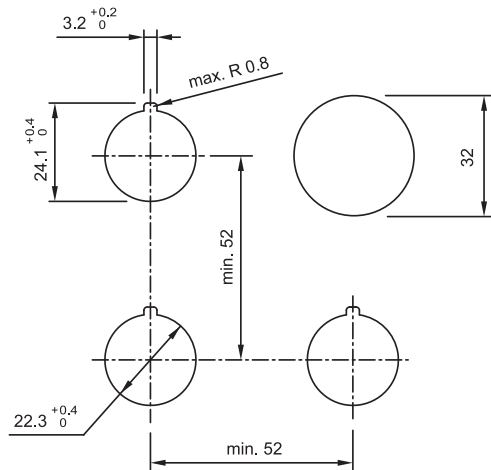

3 Illuminated pushbutton actuator page 127 | Pushbutton actuator page 128

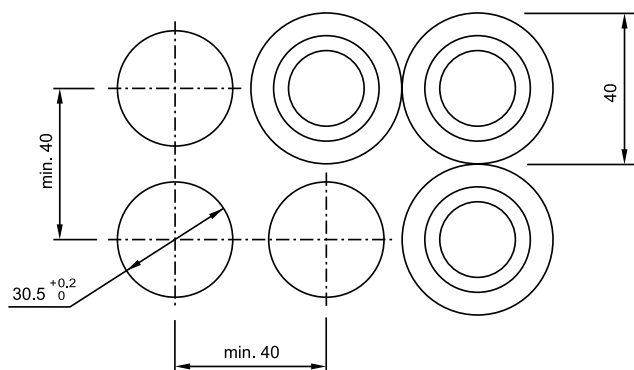

Technical drawing

1 Blind plug page 134

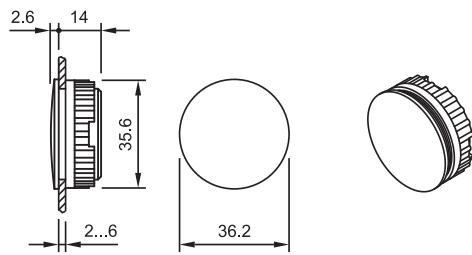

7 Legend frame page 133

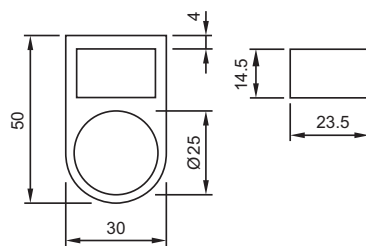

8 Blind plug page 134

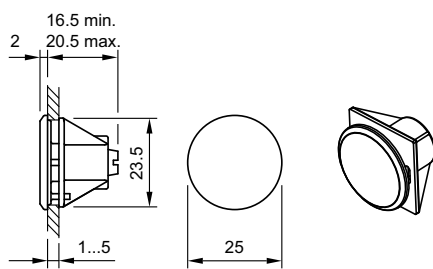

With this print version of the series 84, the panel thickness is reduced to 2.5 mm max.

9 Illumination element PCB mounting page 139

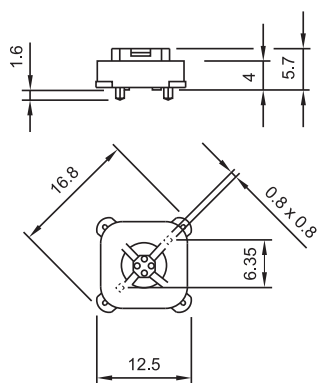

10 Mounting flange page 139

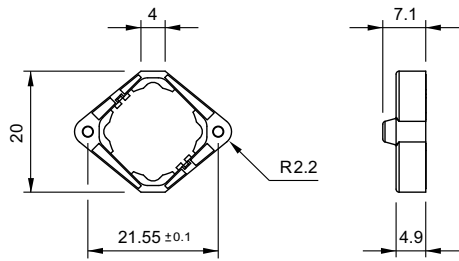

12 Emergency-stop protective shroud page 141

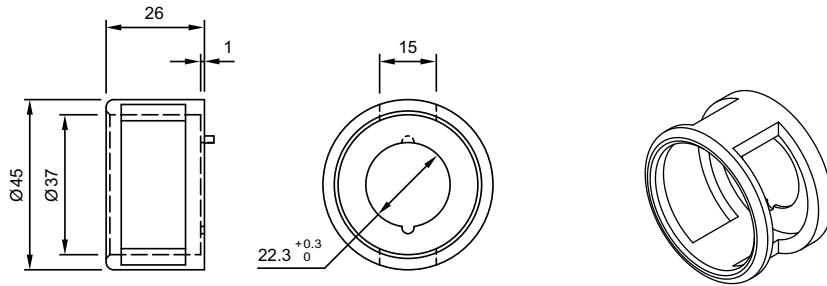

13 Mounting flange page 139

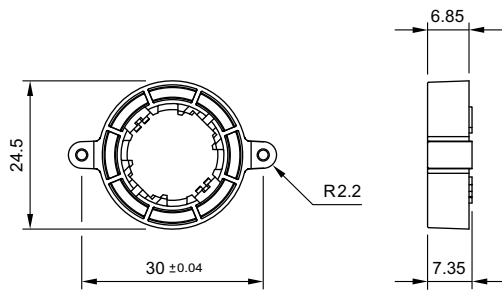

14 Emergency-stop protective shroud page 141

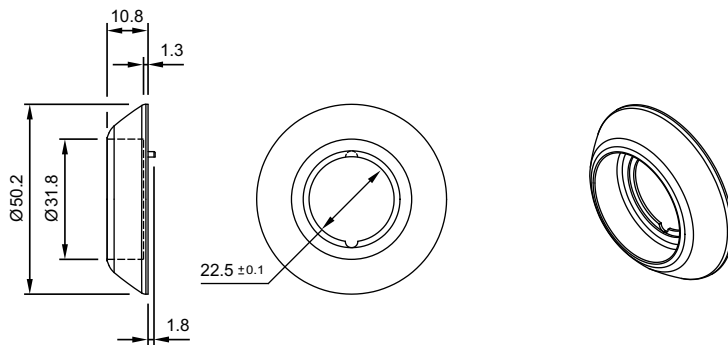

15 Switching element PCB mounting illuminative page 139

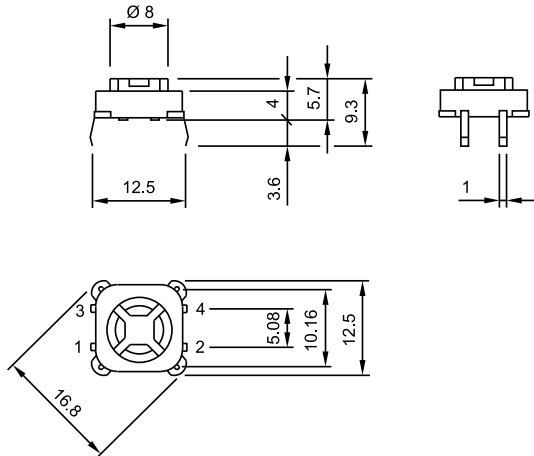

16 Indicator actuator page 127 | Illuminated pushbutton actuator page 127 | Pushbutton actuator page 128 | Indicator actuator with ring illumination (illuminated bezel) page 128 | Pushbutton actuator with ring illumination (illuminated bezel) page 129 | Indicator actuator with ring illumination (illuminated multi-colour bezel) page 129 | Pushbutton actuator with ring illumination (illuminated multi-colour bezel) page 130

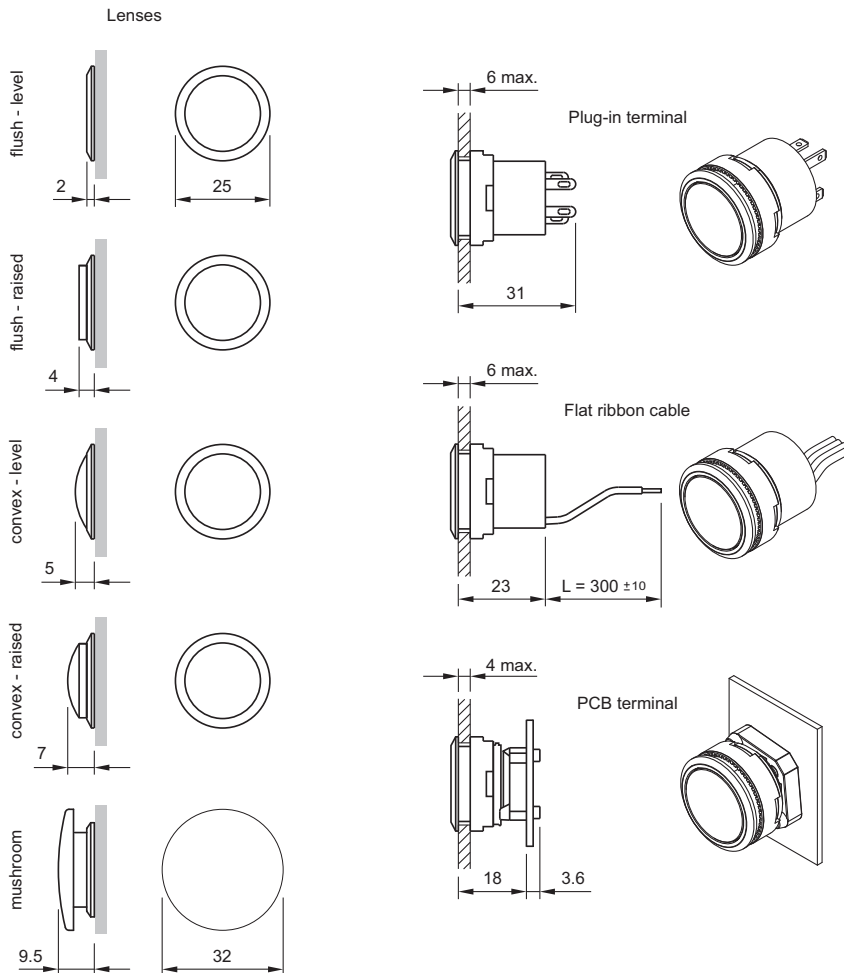

17 Emergency-stop pushbutton, foolproof EN IEC 60947-5-5, complete page 125 | Stop pushbutton grey, complete page 126

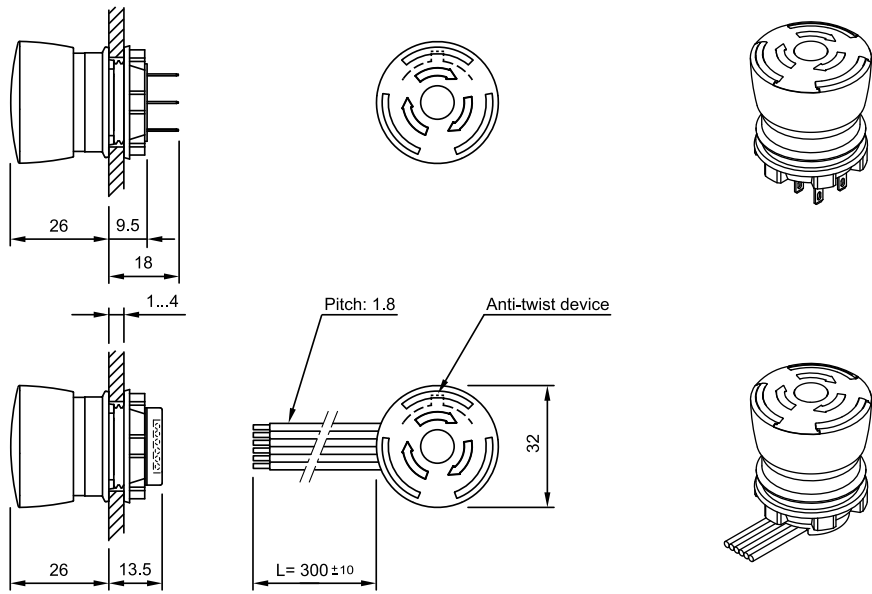

18 Illuminated pushbutton actuator page 127 | Pushbutton actuator page 128

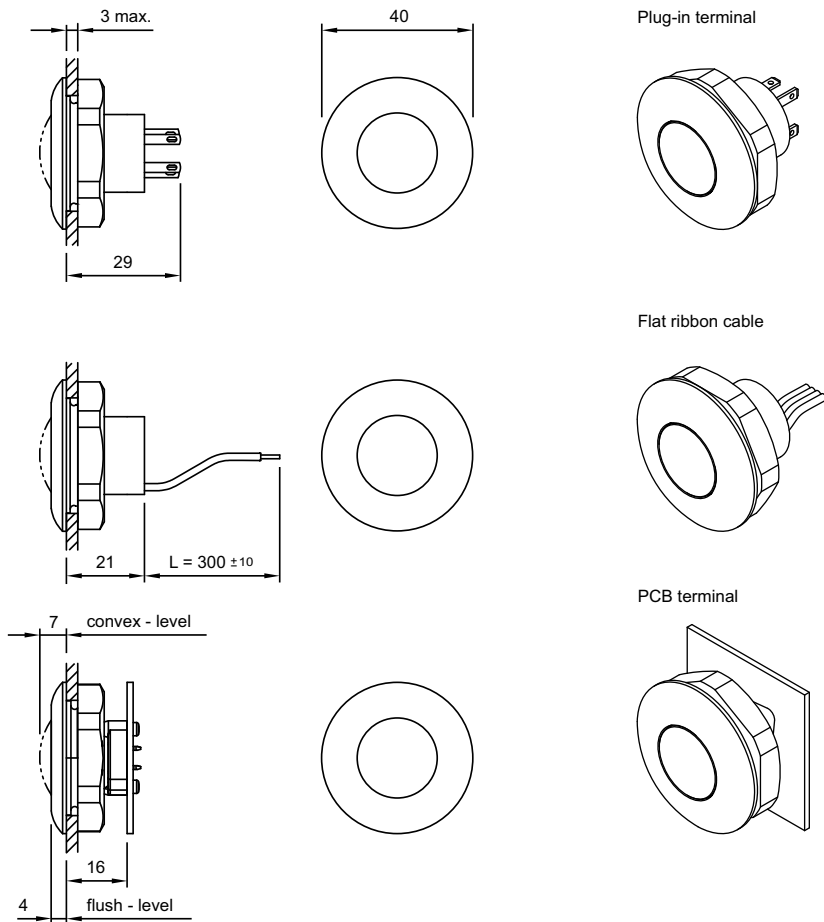

Circuit drawing

1 Illumination element with Bi-colour illumination page 136

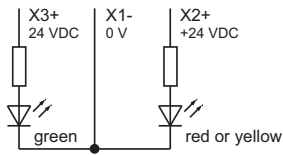

2 Illumination element with Bi-colour illumination page 136

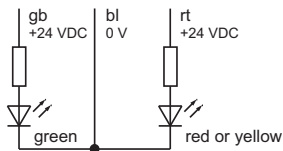

3 Switching element with Bi-colour illumination page 138

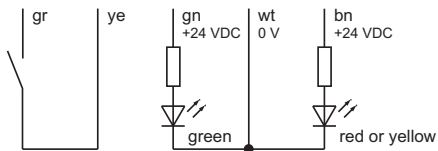

4 Illuminated pushbutton actuator page 127 | Pushbutton actuator page 128 | Pushbutton actuator with ring illumination (illuminated bezel) page 129 | Pushbutton actuator with ring illumination (illuminated multi-colour bezel) page 130



5 Illumination element page 135

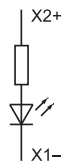

6 Switching element non-illuminated page 138



7 Switching element illuminated page 137

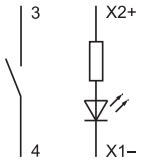

8 Emergency-stop pushbutton, foolproof EN IEC 60947-5-5, complete page 125 | **Stop pushbutton grey, complete** page 126

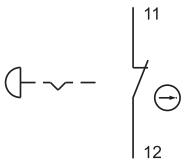

9 Emergency-stop pushbutton, foolproof EN IEC 60947-5-5, complete page 125 | **Stop pushbutton grey, complete** page 126

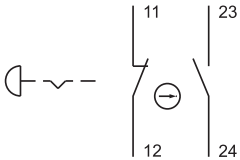

10 Emergency-stop pushbutton, foolproof EN IEC 60947-5-5, complete page 125 | **Stop pushbutton grey, complete** page 126

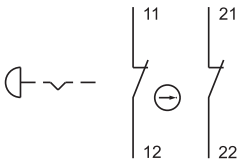

11 Emergency-stop pushbutton, foolproof EN IEC 60947-5-5, complete page 125 | **Stop pushbutton grey, complete** page 126

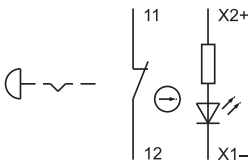

12 Emergency-stop pushbutton, foolproof EN IEC 60947-5-5, complete page 125 | **Stop pushbutton grey, complete** page 126

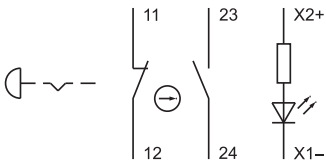

13 Emergency-stop pushbutton, foolproof EN IEC 60947-5-5, complete page 125 | Stop pushbutton grey, complete page 126

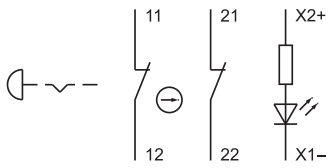

14 Switching element PCB mounting illuminative page 139

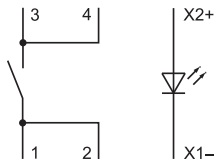

Index from Typ-Nr.

| Typ-Nr. | Page | Typ-Nr. | Page | Typ-Nr. | Page |
|---------------|------|-------------|------|------------|------|
| 01-907 | 63 | 18-030.0055 | 95 | 18-267.035 | 96 |
| 10-1606.1309 | 111 | 18-031.0052 | 95 | 18-268.035 | 96 |
| 10-1606.1309 | 42 | 18-031.0054 | 95 | 18-287.035 | 96 |
| 10-1609.1199 | 111 | 18-031.0055 | 95 | 18-288.035 | 96 |
| 10-1609.1199 | 42 | 18-032.0052 | 95 | 18-910 | 63 |
| 10-1612.1179 | 111 | 18-032.0054 | 95 | 18-910 | 98 |
| 10-1612.1179 | 42 | 18-032.0055 | 95 | 18-920.1 | 98 |
| 10-1613.1189 | 42 | 18-040.0052 | 95 | 18-920.2 | 98 |
| 10-1616.1179 | 42 | 18-040.0054 | 95 | 18-920.3 | 98 |
| 10-2602.3172C | 111 | 18-040.0055 | 95 | 18-931.2 | 97 |
| 10-2602.3172C | 43 | 18-041.0052 | 95 | 18-931.4 | 97 |
| 10-2602.3172E | 84 | 18-041.0054 | 95 | 18-931.5 | 97 |
| 10-2602.3172F | 25 | 18-041.0055 | 95 | 18-932.0 | 97 |
| 10-2602.3172G | 25 | 18-042.0052 | 95 | 18-932.2 | 97 |
| 10-2602.3172J | 84 | 18-042.0054 | 95 | 18-932.4 | 97 |
| 10-2602.3174C | 111 | 18-042.0055 | 95 | 18-932.5 | 97 |
| 10-2602.3174C | 43 | 18-050.0052 | 95 | 18-932.8 | 97 |
| 10-2602.3174D | 140 | 18-050.0054 | 95 | 18-932.9 | 97 |
| 10-2602.3174D | 62 | 18-050.0055 | 95 | 18-941.2 | 97 |
| 10-2602.3174E | 84 | 18-051.0052 | 95 | 18-941.4 | 97 |
| 10-2602.3174F | 25 | 18-051.0054 | 95 | 18-941.5 | 97 |
| 10-2602.3174G | 25 | 18-051.0055 | 95 | 18-942.0 | 97 |
| 10-2602.3174J | 84 | 18-052.0052 | 95 | 18-942.2 | 97 |
| 10-2602.3175C | 111 | 18-052.0054 | 95 | 18-942.4 | 97 |
| 10-2602.3175C | 43 | 18-052.0055 | 95 | 18-942.5 | 97 |
| 10-2602.3175E | 84 | 18-060.0052 | 96 | 18-942.8 | 97 |
| 10-2602.3175F | 25 | 18-060.0054 | 96 | 18-942.9 | 97 |
| 10-2602.3175G | 25 | 18-060.0055 | 96 | 18-945 | 98 |
| 10-2602.3175J | 84 | 18-061.0052 | 96 | 18-946 | 98 |
| 10-2602.3202L | 140 | 18-061.0054 | 96 | 18-951.2 | 97 |
| 10-2602.3202L | 62 | 18-061.0055 | 96 | 18-951.4 | 97 |
| 10-2602.3203L | 140 | 18-062.0052 | 96 | 18-951.5 | 97 |
| 10-2602.3203L | 62 | 18-062.0054 | 96 | 18-952.0 | 97 |
| 10-2602.3205L | 140 | 18-062.0055 | 96 | 18-952.2 | 97 |
| 10-2602.3205L | 62 | 18-080.0052 | 96 | 18-952.4 | 97 |
| 10-2602.3206L | 140 | 18-080.0054 | 96 | 18-952.5 | 97 |
| 10-2602.3206L | 62 | 18-080.0055 | 96 | 18-952.8 | 97 |
| 10-2602.3209L | 140 | 18-081.0052 | 96 | 18-952.9 | 97 |
| 10-2602.3209L | 62 | 18-081.0054 | 96 | 18-961.2 | 97 |
| 10-2603.3179C | 111 | 18-081.0055 | 96 | 18-961.4 | 97 |
| 10-2603.3179C | 43 | 18-082.0052 | 96 | 18-961.5 | 97 |
| 10-2603.320AL | 140 | 18-082.0054 | 96 | 18-962.0 | 97 |
| 10-2603.320AL | 62 | 18-082.0055 | 96 | 18-962.2 | 97 |
| 10-2603.320CL | 140 | 18-137.035 | 95 | 18-962.4 | 97 |
| 10-2603.320CL | 62 | 18-138.035 | 95 | 18-962.5 | 97 |
| 10-4613.3102B | 111 | 18-147.035 | 95 | 18-962.8 | 97 |
| 10-4613.3102B | 43 | 18-148.035 | 95 | 18-962.9 | 97 |
| 10-4613.3103B | 111 | 18-157.035 | 95 | 18-981.2 | 97 |
| 10-4613.3103B | 43 | 18-158.035 | 95 | 18-981.4 | 97 |
| 10-4613.3104B | 111 | 18-167.035 | 96 | 18-981.5 | 97 |
| 10-4613.3104B | 43 | 18-168.035 | 96 | 18-982.0 | 97 |
| 10-4613.3105B | 111 | 18-187.035 | 96 | 18-982.2 | 97 |
| 10-4613.3105B | 43 | 18-188.035 | 96 | 18-982.4 | 97 |
| 10-5609.3174D | 140 | 18-237.035 | 95 | 18-982.5 | 97 |
| 10-5609.3174D | 62 | 18-238.035 | 95 | 18-982.8 | 97 |
| 11-906 | 112 | 18-247.035 | 95 | 18-982.9 | 97 |
| 11-906 | 43 | 18-248.035 | 95 | 19-030.005 | 109 |
| 18-030.0052 | 95 | 18-257.035 | 95 | 19-031.005 | 109 |
| 18-030.0054 | 95 | 18-258.035 | 95 | 19-050.005 | 109 |

Index from Typ-Nr.

| Typ-Nr. | Page | Typ-Nr. | Page | Typ-Nr. | Page |
|------------|------|--------------|------|--------------|------|
| 19-051.005 | 109 | 51-910 | 62 | 84-5130.0040 | 125 |
| 19-139.015 | 109 | 51-948.0 | 61 | 84-5131.2B20 | 125 |
| 19-139.035 | 109 | 61-9453.0 | 134 | 84-5131.2B40 | 125 |
| 19-159.015 | 109 | 61-9707.7 | 131 | 84-5140.0020 | 125 |
| 19-159.035 | 109 | 61-9730.0 | 142 | 84-5140.0040 | 125 |
| 19-279.015 | 109 | 61-9980.0 | 133 | 84-5141.2B20 | 125 |
| 19-279.035 | 109 | 704.963.0 | 141 | 84-5141.2B40 | 125 |
| 19-289.015 | 109 | 704.963.1 | 141 | 84-6020.0020 | 126 |
| 19-289.035 | 109 | 704.963.2 | 141 | 84-6020.0040 | 126 |
| 19-431.035 | 109 | 704.963.3 | 141 | 84-6021.2B20 | 126 |
| 19-432.035 | 109 | 704.963.5 | 141 | 84-6021.2B40 | 126 |
| 19-451.035 | 109 | 704.963.6 | 141 | 84-6030.0020 | 126 |
| 19-452.035 | 109 | 704.963.7 | 141 | 84-6030.0040 | 126 |
| 19-471.035 | 109 | 704.963.8 | 141 | 84-6031.2B20 | 126 |
| 19-472.035 | 109 | 704.964.8 | 134 | 84-6031.2B40 | 126 |
| 19-481.035 | 109 | 704.968.0 | 134 | 84-6040.0020 | 126 |
| 19-482.035 | 109 | 704.968.1 | 134 | 84-6040.0040 | 126 |
| 19-905 | 112 | 84-0080.7 | 129 | 84-6041.2B20 | 126 |
| 19-905 | 99 | 84-0090.7 | 128 | 84-6041.2B40 | 126 |
| 19-906 | 112 | 84-0100.0 | 127 | 84-7111.200 | 131 |
| 19-910 | 112 | 84-0200.7 | 127 | 84-7111.201 | 131 |
| 19-910 | 25 | 84-1081.7 | 130 | 84-7111.202 | 131 |
| 19-931.0 | 110 | 84-1091.7 | 129 | 84-7111.203 | 131 |
| 19-931.2 | 110 | 84-1101.0 | 127 | 84-7111.300 | 131 |
| 19-931.4 | 110 | 84-1101.0 | 128 | 84-7111.301 | 131 |
| 19-931.5 | 110 | 84-1201.0 | 127 | 84-7111.400 | 131 |
| 19-931.6 | 110 | 84-1201.0 | 128 | 84-7111.401 | 131 |
| 19-931.8 | 110 | 84-1201.2 | 127 | 84-7111.500 | 131 |
| 19-931.9 | 110 | 84-1201.2 | 128 | 84-7111.501 | 131 |
| 19-932.2 | 110 | 84-1201.4 | 127 | 84-7111.502 | 131 |
| 19-932.4 | 110 | 84-1201.4 | 128 | 84-7111.503 | 131 |
| 19-932.5 | 110 | 84-1201.5 | 127 | 84-7111.600 | 131 |
| 19-932.6 | 110 | 84-1201.5 | 128 | 84-7111.601 | 131 |
| 19-932.7 | 110 | 84-1201.6 | 127 | 84-7111.602 | 131 |
| 19-940 | 110 | 84-1201.6 | 128 | 84-7111.603 | 131 |
| 19-941 | 110 | 84-1201.7 | 127 | 84-7111.700 | 131 |
| 19-948.0 | 110 | 84-1201.7 | 128 | 84-7111.701 | 131 |
| 19-948.0 | 98 | 84-1221.7 | 127 | 84-7111.702 | 131 |
| 19-949.0 | 110 | 84-1221.7 | 128 | 84-7111.703 | 131 |
| 19-949.0 | 98 | 84-2101.0 | 127 | 84-7114.600A | 133 |
| 19-951.0 | 110 | 84-2101.0 | 128 | 84-7115.200 | 131 |
| 19-951.2 | 110 | 84-3100.0 | 127 | 84-7115.300 | 131 |
| 19-951.4 | 110 | 84-5020.0020 | 125 | 84-7115.400 | 131 |
| 19-951.5 | 110 | 84-5020.0040 | 125 | 84-7115.500 | 131 |
| 19-951.6 | 110 | 84-5021.2B20 | 125 | 84-7115.600 | 131 |
| 19-951.8 | 110 | 84-5021.2B40 | 125 | 84-7115.700 | 131 |
| 19-951.9 | 110 | 84-5030.0020 | 125 | 84-7121.000 | 131 |
| 19-952.2 | 110 | 84-5030.0040 | 125 | 84-7121.800 | 131 |
| 19-952.4 | 110 | 84-5031.2B20 | 125 | 84-7124.000A | 133 |
| 19-952.5 | 110 | 84-5031.2B40 | 125 | 84-7124.200A | 133 |
| 19-952.6 | 110 | 84-5040.0020 | 125 | 84-7124.400A | 133 |
| 19-952.7 | 110 | 84-5040.0040 | 125 | 84-7124.500A | 133 |
| 19-991 | 112 | 84-5041.2B20 | 125 | 84-7124.600A | 133 |
| 31-928 | 111 | 84-5041.2B40 | 125 | 84-7125.000 | 131 |
| 31-929 | 140 | 84-5120.0020 | 125 | 84-7125.800 | 131 |
| 31-929 | 142 | 84-5120.0040 | 125 | 84-7201.000 | 132 |
| 31-945 | 111 | 84-5121.2B20 | 125 | 84-7201.200 | 132 |
| 31-946 | 141 | 84-5121.2B40 | 125 | 84-7201.400 | 132 |
| 31-989.311 | 42 | 84-5130.0020 | 125 | 84-7201.500 | 132 |

Index from Typ-Nr.

| Typ-Nr. | Page | Typ-Nr. | Page | Typ-Nr. | Page |
|--------------|------|--------------|------|------------|------|
| 84-7201.600 | 132 | 84-8001.9340 | 135 | 92-058.500 | 58 |
| 84-7201.800 | 132 | 84-8001.9620 | 135 | 92-058.600 | 58 |
| 84-7202.000 | 132 | 84-8001.9640 | 135 | 92-058.700 | 58 |
| 84-7202.000A | 132 | 84-8005.7620 | 136 | 92-140.000 | 65 |
| 84-7202.200 | 132 | 84-8005.7640 | 136 | 92-143.200 | 58 |
| 84-7202.200A | 132 | 84-8005.8620 | 136 | 92-143.300 | 58 |
| 84-7202.400 | 132 | 84-8005.8640 | 136 | 92-143.400 | 58 |
| 84-7202.400A | 132 | 84-8510.0020 | 138 | 92-143.500 | 58 |
| 84-7202.500 | 132 | 84-8510.0040 | 138 | 92-143.600 | 58 |
| 84-7202.500B | 132 | 84-8511.2320 | 137 | 92-143.700 | 58 |
| 84-7202.600 | 132 | 84-8511.2340 | 137 | 92-158.100 | 58 |
| 84-7202.600A | 132 | 84-8511.2620 | 137 | 92-158.200 | 58 |
| 84-7202.800 | 132 | 84-8511.2640 | 137 | 92-158.300 | 58 |
| 84-7202.800A | 132 | 84-8511.3320 | 137 | 92-158.400 | 58 |
| 84-7205.000 | 132 | 84-8511.3340 | 137 | 92-158.500 | 58 |
| 84-7205.000A | 132 | 84-8511.3620 | 137 | 92-158.600 | 58 |
| 84-7205.200 | 132 | 84-8511.3640 | 137 | 92-158.700 | 58 |
| 84-7205.200A | 132 | 84-8511.4320 | 137 | 92-340.000 | 64 |
| 84-7205.400 | 132 | 84-8511.4340 | 137 | 92-341.000 | 59 |
| 84-7205.400A | 132 | 84-8511.4620 | 137 | 92-341.800 | 59 |
| 84-7205.500 | 132 | 84-8511.4640 | 137 | 92-343.200 | 60 |
| 84-7205.500A | 132 | 84-8511.5320 | 137 | 92-343.300 | 60 |
| 84-7205.600 | 132 | 84-8511.5340 | 137 | 92-343.400 | 60 |
| 84-7205.600A | 132 | 84-8511.5620 | 137 | 92-343.500 | 60 |
| 84-7205.800 | 132 | 84-8511.5640 | 137 | 92-343.600 | 60 |
| 84-7205.800A | 132 | 84-8511.6320 | 137 | 92-343.700 | 60 |
| 84-7211.000 | 133 | 84-8511.6340 | 137 | 92-350.000 | 64 |
| 84-7211.200 | 133 | 84-8511.6620 | 137 | 92-356.000 | 59 |
| 84-7211.400 | 133 | 84-8511.6640 | 137 | 92-356.800 | 59 |
| 84-7211.500 | 133 | 84-8511.9320 | 137 | 92-356.900 | 59 |
| 84-7211.600 | 133 | 84-8511.9340 | 137 | 92-358.100 | 60 |
| 84-7211.800 | 133 | 84-8511.9620 | 137 | 92-358.200 | 60 |
| 84-7215.000 | 133 | 84-8511.9640 | 137 | 92-358.300 | 60 |
| 84-7215.200 | 133 | 84-8515.7640 | 138 | 92-358.400 | 60 |
| 84-7215.400 | 133 | 84-8515.8640 | 138 | 92-358.500 | 60 |
| 84-7215.500 | 133 | 84-900 | 140 | 92-358.600 | 60 |
| 84-7215.600 | 133 | 84-902 | 141 | 92-358.700 | 60 |
| 84-7215.800 | 133 | 84-902A | 141 | 92-440.000 | 64 |
| 84-8001.2320 | 135 | 84-902B | 141 | 92-441.000 | 59 |
| 84-8001.2340 | 135 | 84-902D | 141 | 92-441.800 | 59 |
| 84-8001.2620 | 135 | 84-905 | 141 | 92-443.200 | 60 |
| 84-8001.2640 | 135 | 84-908 | 141 | 92-443.300 | 60 |
| 84-8001.3320 | 135 | 84-909 | 141 | 92-443.400 | 60 |
| 84-8001.3340 | 135 | 84-9103.7 | 133 | 92-443.500 | 60 |
| 84-8001.3620 | 135 | 84-9420 | 139 | 92-443.600 | 60 |
| 84-8001.3640 | 135 | 84-960.0 | 139 | 92-443.700 | 60 |
| 84-8001.4320 | 135 | 84-996 | 142 | 92-450.000 | 64 |
| 84-8001.4340 | 135 | 84-997 | 142 | 92-456.000 | 59 |
| 84-8001.4620 | 135 | 84-998 | 142 | 92-456.800 | 59 |
| 84-8001.4640 | 135 | 92-043.200 | 58 | 92-456.900 | 59 |
| 84-8001.5320 | 135 | 92-043.300 | 58 | 92-458.100 | 60 |
| 84-8001.5340 | 135 | 92-043.400 | 58 | 92-458.200 | 60 |
| 84-8001.5620 | 135 | 92-043.500 | 58 | 92-458.300 | 60 |
| 84-8001.5640 | 135 | 92-043.600 | 58 | 92-458.400 | 60 |
| 84-8001.6320 | 135 | 92-043.700 | 58 | 92-458.500 | 60 |
| 84-8001.6340 | 135 | 92-058.100 | 58 | 92-458.600 | 60 |
| 84-8001.6620 | 135 | 92-058.200 | 58 | 92-458.700 | 60 |
| 84-8001.6640 | 135 | 92-058.300 | 58 | 92-800.042 | 139 |
| 84-8001.9320 | 135 | 92-058.400 | 58 | 92-800.042 | 61 |

Index from Typ-Nr.

| Typ-Nr. | Page | Typ-Nr. | Page | Typ-Nr. | Page |
|------------|------|------------|------|-----------|------|
| 92-851.342 | 139 | 95-803.420 | 10 | 96-907.0 | 79 |
| 92-851.342 | 61 | 95-803.520 | 10 | 96-907.01 | 83 |
| 92-912.0 | 64 | 95-803.620 | 10 | 96-907.2 | 79 |
| 92-912.9 | 64 | 95-803.720 | 10 | 96-907.21 | 83 |
| 92-941.000 | 65 | 95-803.820 | 10 | 96-907.5 | 79 |
| 92-941.200 | 65 | 95-803.920 | 10 | 96-907.51 | 83 |
| 92-941.300 | 65 | 95-804.220 | 10 | 96-907.8 | 79 |
| 92-941.400 | 65 | 95-804.320 | 10 | 96-907.81 | 83 |
| 92-941.500 | 65 | 95-804.420 | 10 | 96-908.0 | 84 |
| 92-941.600 | 65 | 95-804.520 | 10 | 96-908.2 | 84 |
| 92-941.700 | 65 | 95-804.620 | 10 | 96-908.5 | 84 |
| 92-941.800 | 65 | 95-804.720 | 10 | 96-908.8 | 84 |
| 92-956.000 | 64 | 95-804.820 | 10 | 96-909.0 | 78 |
| 92-956.200 | 64 | 95-804.920 | 10 | 96-909.2 | 78 |
| 92-956.300 | 64 | 95-805.920 | 10 | 96-909.5 | 78 |
| 92-956.400 | 64 | 95-900.005 | 11 | 96-909.8 | 78 |
| 92-956.500 | 64 | 95-900.009 | 11 | 96-910.0 | 78 |
| 92-956.600 | 64 | 96-302.807 | 77 | 96-910.2 | 78 |
| 92-956.800 | 64 | 96-323.837 | 77 | 96-910.5 | 78 |
| 92-956.900 | 64 | 96-901.0 | 80 | 96-910.8 | 78 |
| 92-958.100 | 64 | 96-901.01 | 83 | 96-921.0 | 80 |
| 92-958.200 | 64 | 96-901.2 | 80 | 96-921.2 | 80 |
| 92-958.300 | 64 | 96-901.21 | 83 | 96-921.5 | 80 |
| 92-958.400 | 64 | 96-901.5 | 80 | 96-921.8 | 80 |
| 92-958.500 | 64 | 96-901.51 | 83 | 96-922.0 | 80 |
| 92-958.600 | 64 | 96-901.8 | 80 | 96-922.2 | 80 |
| 92-958.700 | 64 | 96-901.81 | 83 | 96-922.5 | 80 |
| 92-960.0 | 139 | 96-902.0 | 80 | 96-922.8 | 80 |
| 92-960.0 | 63 | 96-902.01 | 83 | 96-923.0 | 80 |
| 92-965.0 | 61 | 96-902.2 | 80 | 96-923.2 | 80 |
| 92-971.0 | 63 | 96-902.21 | 83 | 96-923.5 | 80 |
| 92-981.0 | 62 | 96-902.5 | 80 | 96-923.8 | 80 |
| 95-313.000 | 10 | 96-902.51 | 83 | 96-925.0 | 79 |
| 95-313.720 | 9 | 96-902.8 | 80 | 96-925.2 | 79 |
| 95-313.750 | 9 | 96-902.81 | 83 | 96-925.5 | 79 |
| 95-414.000 | 10 | 96-903.0 | 80 | 96-925.8 | 79 |
| 95-414.730 | 9 | 96-903.01 | 83 | 96-926.0 | 79 |
| 95-414.740 | 9 | 96-903.2 | 80 | 96-926.2 | 79 |
| 95-414.750 | 9 | 96-903.21 | 83 | 96-926.5 | 79 |
| 95-414.770 | 9 | 96-903.5 | 80 | 96-926.8 | 79 |
| 95-515.000 | 10 | 96-903.51 | 83 | 96-927.0 | 79 |
| 95-515.720 | 9 | 96-903.8 | 80 | 96-927.2 | 79 |
| 95-515.740 | 9 | 96-903.81 | 83 | 96-927.5 | 79 |
| 95-515.750 | 9 | 96-905.0 | 79 | 96-927.8 | 79 |
| 95-515.770 | 9 | 96-905.01 | 83 | 96-928.0 | 84 |
| 95-703.720 | 10 | 96-905.2 | 79 | 96-928.2 | 84 |
| 95-703.750 | 10 | 96-905.21 | 83 | 96-928.5 | 84 |
| 95-704.720 | 10 | 96-905.5 | 79 | 96-928.8 | 84 |
| 95-704.730 | 10 | 96-905.51 | 83 | 96-929.0 | 78 |
| 95-704.740 | 10 | 96-905.8 | 79 | 96-929.2 | 78 |
| 95-704.750 | 10 | 96-905.81 | 83 | 96-929.5 | 78 |
| 95-704.760 | 10 | 96-906.0 | 79 | 96-929.8 | 78 |
| 95-704.770 | 10 | 96-906.01 | 83 | 96-930.0 | 78 |
| 95-705.720 | 10 | 96-906.2 | 79 | 96-930.2 | 78 |
| 95-705.730 | 10 | 96-906.21 | 83 | 96-930.5 | 78 |
| 95-705.740 | 10 | 96-906.5 | 79 | 96-930.8 | 78 |
| 95-705.770 | 10 | 96-906.51 | 83 | 96-931.0 | 80 |
| 95-803.220 | 10 | 96-906.8 | 79 | 96-931.2 | 80 |
| 95-803.320 | 10 | 96-906.81 | 83 | 96-931.5 | 80 |

Index from Typ-Nr.

| Typ-Nr. | Page | Typ-Nr. | Page | Typ-Nr. | Page |
|----------|------|------------|------|----------|------|
| 96-931.8 | 80 | 96-951.5 | 83 | 97-951.4 | 24 |
| 96-932.0 | 80 | 96-951.8 | 83 | 97-951.5 | 24 |
| 96-932.2 | 80 | 97-041.007 | 21 | 97-951.6 | 24 |
| 96-932.5 | 80 | 97-061.007 | 21 | 97-951.8 | 24 |
| 96-932.8 | 80 | 97-081.007 | 21 | 97-951.9 | 24 |
| 96-933.0 | 80 | 97-320.037 | 23 | 97-952.2 | 24 |
| 96-933.2 | 80 | 97-321.037 | 23 | 97-952.4 | 24 |
| 96-933.5 | 80 | 97-322.037 | 23 | 97-952.5 | 24 |
| 96-933.8 | 80 | 97-323.037 | 23 | 97-952.6 | 24 |
| 96-935.0 | 79 | 97-330.037 | 22 | 97-952.7 | 24 |
| 96-935.2 | 79 | 97-331.037 | 22 | 98-901.2 | 80 |
| 96-935.5 | 79 | 97-332.037 | 22 | 98-901.3 | 80 |
| 96-935.8 | 79 | 97-333.037 | 22 | 98-901.4 | 80 |
| 96-936.0 | 79 | 97-350.037 | 22 | 98-901.5 | 80 |
| 96-936.2 | 79 | 97-351.037 | 22 | 98-901.6 | 80 |
| 96-936.5 | 79 | 97-352.037 | 22 | 98-901.8 | 80 |
| 96-936.8 | 79 | 97-353.037 | 22 | 98-901.9 | 80 |
| 96-937.0 | 79 | 97-360.037 | 23 | 98-902.2 | 80 |
| 96-937.2 | 79 | 97-361.037 | 23 | 98-902.3 | 80 |
| 96-937.5 | 79 | 97-362.037 | 23 | 98-902.4 | 80 |
| 96-937.8 | 79 | 97-363.037 | 23 | 98-902.5 | 80 |
| 96-938.0 | 84 | 97-370.037 | 22 | 98-902.6 | 80 |
| 96-938.2 | 84 | 97-371.037 | 22 | 98-902.8 | 80 |
| 96-938.5 | 84 | 97-372.037 | 22 | 98-902.9 | 80 |
| 96-938.8 | 84 | 97-373.037 | 22 | 98-903.2 | 80 |
| 96-939.0 | 78 | 97-380.037 | 22 | 98-903.3 | 80 |
| 96-939.2 | 78 | 97-381.037 | 22 | 98-903.4 | 80 |
| 96-939.5 | 78 | 97-382.037 | 22 | 98-903.5 | 80 |
| 96-939.8 | 78 | 97-383.037 | 22 | 98-903.6 | 80 |
| 96-940.0 | 78 | 97-908.9 | 25 | 98-903.8 | 80 |
| 96-940.2 | 78 | 97-909.7 | 25 | 98-903.9 | 80 |
| 96-940.5 | 78 | 97-910.9 | 24 | 98-905.2 | 79 |
| 96-940.8 | 78 | 97-920.8 | 25 | 98-905.3 | 79 |
| 96-941.0 | 82 | 97-920.83 | 25 | 98-905.4 | 79 |
| 96-941.2 | 82 | 97-921.2 | 24 | 98-905.5 | 79 |
| 96-941.5 | 82 | 97-921.4 | 24 | 98-905.6 | 79 |
| 96-941.8 | 82 | 97-921.5 | 24 | 98-905.8 | 79 |
| 96-942.0 | 82 | 97-921.6 | 24 | 98-905.9 | 79 |
| 96-942.2 | 82 | 97-921.7 | 24 | 98-906.2 | 79 |
| 96-942.5 | 82 | 97-927.2 | 24 | 98-906.3 | 79 |
| 96-942.8 | 82 | 97-927.4 | 24 | 98-906.4 | 79 |
| 96-943.0 | 82 | 97-927.5 | 24 | 98-906.5 | 79 |
| 96-943.2 | 82 | 97-927.6 | 24 | 98-906.6 | 79 |
| 96-943.5 | 82 | 97-927.7 | 24 | 98-906.8 | 79 |
| 96-943.8 | 82 | 97-929.7A | 24 | 98-906.9 | 79 |
| 96-945.0 | 81 | 97-931.0 | 24 | 98-907.2 | 79 |
| 96-945.2 | 81 | 97-931.2 | 24 | 98-907.3 | 79 |
| 96-945.5 | 81 | 97-931.4 | 24 | 98-907.4 | 79 |
| 96-945.8 | 81 | 97-931.5 | 24 | 98-907.5 | 79 |
| 96-946.0 | 81 | 97-931.6 | 24 | 98-907.6 | 79 |
| 96-946.2 | 81 | 97-931.8 | 24 | 98-907.8 | 79 |
| 96-946.5 | 81 | 97-931.9 | 24 | 98-907.9 | 79 |
| 96-946.8 | 81 | 97-932.2 | 24 | 98-921.2 | 80 |
| 96-947.0 | 81 | 97-932.4 | 24 | 98-921.3 | 80 |
| 96-947.2 | 81 | 97-932.5 | 24 | 98-921.4 | 80 |
| 96-947.5 | 81 | 97-932.6 | 24 | 98-921.5 | 80 |
| 96-947.8 | 81 | 97-932.7 | 24 | 98-921.6 | 80 |
| 96-951.0 | 83 | 97-951.0 | 24 | 98-921.8 | 80 |
| 96-951.2 | 83 | 97-951.2 | 24 | 98-921.9 | 80 |

Index from Typ-Nr.

| Typ-Nr. | Page | Typ-Nr. | Page | Typ-Nr. | Page |
|----------|------|----------|------|-------------|------|
| 98-922.2 | 80 | 98-935.5 | 79 | 98-947.9 | 81 |
| 98-922.3 | 80 | 98-935.6 | 79 | 98-968 | 84 |
| 98-922.4 | 80 | 98-935.8 | 79 | 99-050.807 | 35 |
| 98-922.5 | 80 | 98-935.9 | 79 | 99-052.807 | 35 |
| 98-922.6 | 80 | 98-936.2 | 79 | 99-053.807 | 36 |
| 98-922.8 | 80 | 98-936.3 | 79 | 99-210.837D | 39 |
| 98-922.9 | 80 | 98-936.4 | 79 | 99-211.837D | 39 |
| 98-923.2 | 80 | 98-936.5 | 79 | 99-213.837D | 39 |
| 98-923.3 | 80 | 98-936.6 | 79 | 99-230.837D | 39 |
| 98-923.4 | 80 | 98-936.8 | 79 | 99-231.837D | 39 |
| 98-923.5 | 80 | 98-936.9 | 79 | 99-233.837D | 39 |
| 98-923.6 | 80 | 98-937.2 | 79 | 99-250.837D | 39 |
| 98-923.8 | 80 | 98-937.3 | 79 | 99-251.837D | 39 |
| 98-923.9 | 80 | 98-937.4 | 79 | 99-253.837D | 39 |
| 98-925.2 | 79 | 98-937.5 | 79 | 99-311.837D | 39 |
| 98-925.3 | 79 | 98-937.6 | 79 | 99-321.837D | 39 |
| 98-925.4 | 79 | 98-937.8 | 79 | 99-331.837D | 39 |
| 98-925.5 | 79 | 98-937.9 | 79 | 99-341.837D | 39 |
| 98-925.6 | 79 | 98-941.2 | 82 | 99-351.837D | 39 |
| 98-925.8 | 79 | 98-941.3 | 82 | 99-361.837D | 39 |
| 98-925.9 | 79 | 98-941.4 | 82 | 99-371.837D | 39 |
| 98-926.2 | 79 | 98-941.5 | 82 | 99-406.837 | 38 |
| 98-926.3 | 79 | 98-941.6 | 82 | 99-408.837 | 38 |
| 98-926.4 | 79 | 98-941.8 | 82 | 99-416.837 | 38 |
| 98-926.5 | 79 | 98-941.9 | 82 | 99-418.837 | 38 |
| 98-926.6 | 79 | 98-942.2 | 82 | 99-436.837 | 38 |
| 98-926.8 | 79 | 98-942.3 | 82 | 99-438.837 | 38 |
| 98-926.9 | 79 | 98-942.4 | 82 | 99-446.837 | 38 |
| 98-927.2 | 79 | 98-942.5 | 82 | 99-448.837 | 38 |
| 98-927.3 | 79 | 98-942.6 | 82 | 99-450.837 | 37 |
| 98-927.4 | 79 | 98-942.8 | 82 | 99-451.837 | 37 |
| 98-927.5 | 79 | 98-942.9 | 82 | 99-452.837 | 37 |
| 98-927.6 | 79 | 98-943.2 | 82 | 99-453.837 | 37 |
| 98-927.8 | 79 | 98-943.3 | 82 | 99-455.837 | 37 |
| 98-927.9 | 79 | 98-943.4 | 82 | 99-456.837 | 37 |
| 98-931.2 | 80 | 98-943.5 | 82 | 99-457.837 | 37 |
| 98-931.3 | 80 | 98-943.6 | 82 | 99-458.837 | 37 |
| 98-931.4 | 80 | 98-943.8 | 82 | 99-480.837 | 37 |
| 98-931.5 | 80 | 98-943.9 | 82 | 99-481.837 | 37 |
| 98-931.6 | 80 | 98-945.2 | 81 | 99-482.837 | 37 |
| 98-931.8 | 80 | 98-945.3 | 81 | 99-483.837 | 37 |
| 98-931.9 | 80 | 98-945.4 | 81 | 99-485.837 | 37 |
| 98-932.2 | 80 | 98-945.5 | 81 | 99-486.837 | 37 |
| 98-932.3 | 80 | 98-945.6 | 81 | 99-487.837 | 37 |
| 98-932.4 | 80 | 98-945.8 | 81 | 99-488.837 | 37 |
| 98-932.5 | 80 | 98-945.9 | 81 | 99-901.9 | 40 |
| 98-932.6 | 80 | 98-946.2 | 81 | 99-902.9 | 40 |
| 98-932.8 | 80 | 98-946.3 | 81 | 99-908.0 | 40 |
| 98-932.9 | 80 | 98-946.4 | 81 | 99-908.9 | 40 |
| 98-933.2 | 80 | 98-946.5 | 81 | 99-909.2 | 41 |
| 98-933.3 | 80 | 98-946.6 | 81 | 99-909.3 | 41 |
| 98-933.4 | 80 | 98-946.8 | 81 | 99-909.4 | 41 |
| 98-933.5 | 80 | 98-946.9 | 81 | 99-909.5 | 41 |
| 98-933.6 | 80 | 98-947.2 | 81 | 99-909.6 | 41 |
| 98-933.8 | 80 | 98-947.3 | 81 | 99-910 | 43 |
| 98-933.9 | 80 | 98-947.4 | 81 | 99-918.A | 40 |
| 98-935.2 | 79 | 98-947.5 | 81 | 99-920.0 | 40 |
| 98-935.3 | 79 | 98-947.6 | 81 | 99-920.8 | 40 |
| 98-935.4 | 79 | 98-947.8 | 81 | 99-920.82 | 40 |

Index from Typ-Nr.

| Typ-Nr. | Page | Typ-Nr. | Page | Typ-Nr. | Page |
|-----------|------|---------|------|---------|------|
| 99-920.9A | 40 | | | | |
| 99-920.9B | 40 | | | | |
| 99-920.9C | 40 | | | | |
| 99-921.7 | 40 | | | | |
| 99-922.7 | 40 | | | | |
| 99-924.8 | 40 | | | | |
| 99-927.7 | 40 | | | | |
| 99-928.7 | 40 | | | | |
| 99-928.7A | 40 | | | | |
| 99-929.7A | 40 | | | | |
| 99-948.81 | 42 | | | | |
| 99-948.82 | 42 | | | | |
| 99-948.83 | 42 | | | | |
| 99-961.7 | 41 | | | | |
| 99-961.9 | 41 | | | | |
| 99-962.7 | 41 | | | | |
| 99-963.0 | 41 | | | | |
| 99-963.9 | 41 | | | | |
| 99-964.2 | 42 | | | | |
| 99-964.4 | 42 | | | | |
| 99-964.5 | 42 | | | | |
| 99-964.6 | 42 | | | | |
| 99-966.7 | 41 | | | | |
| 99-967.7 | 41 | | | | |
| 99-968.0 | 41 | | | | |
| 99-968.9 | 41 | | | | |
| 99-969.2 | 42 | | | | |
| 99-969.4 | 42 | | | | |
| 99-969.5 | 42 | | | | |
| 99-969.6 | 42 | | | | |
| 99-973.7 | 41 | | | | |
| 99-974.7 | 41 | | | | |
| 99-978.7 | 41 | | | | |
| 99-979.7 | 41 | | | | |
| 99-990 | 43 | | | | |

Notes

EAO – Your Expert Partner for Human Machine Interfaces

| | |
|----------------|--|
| | EAO AG Tannwaldstrasse 88 4601 Olten, Switzerland |
| E-mail | info@eao.com |
| Website | www.eao.com |
| | Austria |
| Phone | +49 201 85 87 0 |
| Fax | +49 201 85 87 210 |
| E-mail | sales.ede@eao.com |
| | Belgium |
| Phone | +32 3 777 82 36 |
| Fax | +32 3 777 84 19 |
| E-mail | sales.ebl@eao.com |
| | China |
| Phone | +852 27 86 91 41 |
| Fax | +852 27 86 95 61 |
| E-mail | sales.ehk@eao.com |
| | France |
| Phone | +33 1 64 43 37 37 |
| Fax | +33 1 64 43 37 49 |
| E-mail | sales.esa@eao.com |
| | Germany |
| Phone | +49 201 85 87 0 |
| Fax | +49 201 85 87 210 |
| E-mail | sales.ede@eao.com |
| | Italy |
| Phone | +39 035 481 0189 |
| Fax | +39 035 481 3786 |
| E-mail | sales.eit@eao.com |
| | Japan |
| Phone | +81 3 5444 5411 |
| Fax | +81 3 5444 0345 |
| E-mail | sales.esj@eao.com |
| | Netherlands |
| Phone | +31 78 653 17 00 |
| Fax | +31 78 653 17 99 |
| E-mail | sales.enl@eao.com |
| | Sweden |
| Phone | +46 8 683 86 60 |
| Fax | +46 8 724 29 12 |
| E-mail | sales.esw@eao.com |
| | Switzerland |
| Phone | +41 62 388 95 00 |
| Fax | +41 62 388 95 55 |
| E-mail | sales.ech@eao.com |
| | United Kingdom |
| Phone | +44 1444 236 000 |
| Fax | +44 1444 236 641 |
| E-mail | sales.euk@eao.com |
| | USA |
| Phone | +1 203 877 4577 |
| Fax | +1 203 877 3694 |
| E-mail | sales.eus@eao.com |
| | Other Countries |
| Phone | +41 62 286 92 10 |
| Fax | +41 62 296 21 62 |
| E-mail | sales@eao.com |



Стандарт Электрон Связь

Мы молодая и активно развивающаяся компания в области поставок электронных компонентов. Мы поставляем электронные компоненты отечественного и импортного производства напрямую от производителей и с крупнейших складов мира.

Благодаря сотрудничеству с мировыми поставщиками мы осуществляем комплексные и плановые поставки широчайшего спектра электронных компонентов.

Собственная эффективная логистика и склад в обеспечивает надежную поставку продукции в точно указанные сроки по всей России.

Мы осуществляем техническую поддержку нашим клиентам и предпродажную проверку качества продукции. На все поставляемые продукты мы предоставляем гарантию .

Осуществляем поставки продукции под контролем ВП МО РФ на предприятия военно-промышленного комплекса России , а также работаем в рамках 275 ФЗ с открытием отдельных счетов в уполномоченном банке. Система менеджмента качества компании соответствует требованиям ГОСТ ISO 9001.

Минимальные сроки поставки, гибкие цены, неограниченный ассортимент и индивидуальный подход к клиентам являются основой для выстраивания долгосрочного и эффективного сотрудничества с предприятиями радиоэлектронной промышленности, предприятиями ВПК и научно-исследовательскими институтами России.

С нами вы становитесь еще успешнее!

Наши контакты:

Телефон: +7 812 627 14 35

Электронная почта: sales@st-electron.ru

Адрес: 198099, Санкт-Петербург,
Промышленная ул, дом № 19, литера Н,
помещение 100-Н Офис 331