

# Series 96

## Characteristics

The Series 96 PCB pushbuttons offer three different lens widths:

- 17.4 × 17.4 mm
- 12.4 × 17.4 mm
- 14.8 × 17.4 mm

## Functions

The Series 96 incorporates the following functions:

- Indicator
- Pushbutton
- Illuminated pushbutton

## Market segments

The EAO Series 96 is especially suited for applications in the segment:

- Audio and video

Please refer to the EAO website to obtain detailed information regarding this series [www.products.eao.com](http://www.products.eao.com)  
Configure a product to your exact needs and request a quotation.

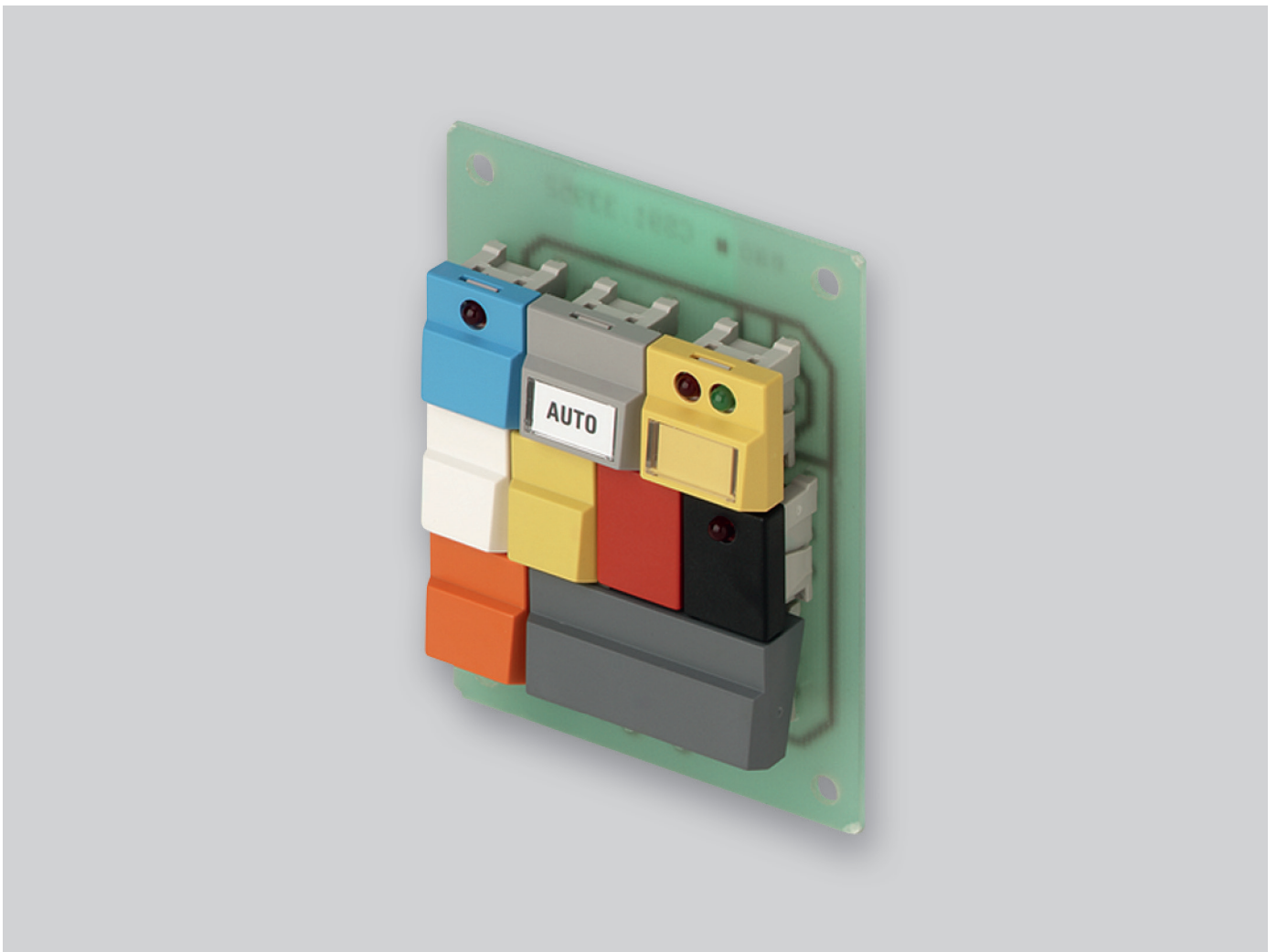



**Übersicht**

<b>PC Pushbuttons</b>	
Illuminated pushbutton	4
<b>Accessories</b>	<b>6</b>
<b>Drawings</b>	<b>13</b>
<b>Technical data</b>	<b>14</b>
<b>Marking</b>	<b>15</b>
<b>Application guidelines</b>	<b>16</b>
<b>Index</b>	<b>17</b>

# 96 PCB pushbuttons

## Illuminated pushbutton IP 67

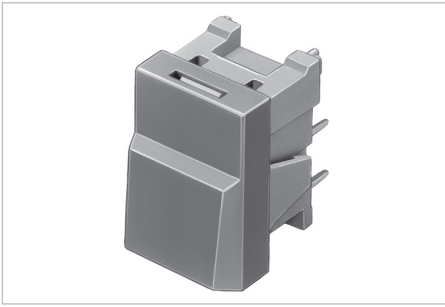

Product can differ from the current configuration.

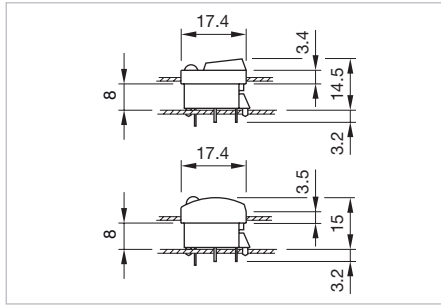

Dimensions [mm]

### Equipment consisting of (schematic overview)



**Lens** page 6



**Single-LED** page 11



**Actuator**

Each Part Number listed below includes all the black components shown in the 3D-drawing.

### Additional Information

- For lens 17.4 x 17.4 mm, 14.8 x 17.4 mm, 12.4 x 17.4 mm

To obtain a complete unit, please select the red components from the pages shown.

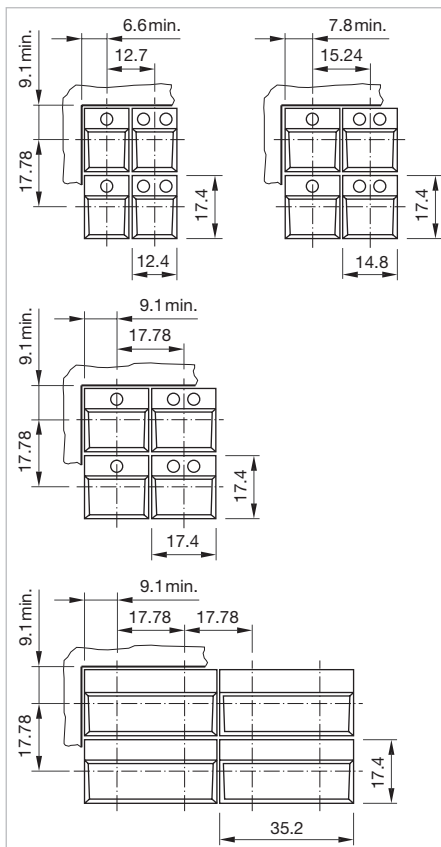

Mounting cut-outs [mm]

Switching system	Contacts	Terminal	Part No.	Component layout	Wiring diagram	Weight
 <p><b>Illuminated pushbutton</b></p>						
Snap-action switching element	1 C	PCB	<b>96-323.837</b>	1	1	0.002 kg



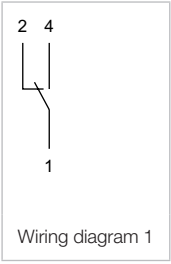

Contacts: C = Changeover  
The component layouts you will find from page 13







## Lens standard single

Lens	Colour	Switching action	Recess for LED	Part No.	Weight
 <p><b>Lens standard single square, 17.4 x 17.4 mm</b></p>					
Plastic black	RAL 9011	B		<b>96-931.0</b>	0.001 kg
Plastic red	RAL 3016	B		<b>96-931.2</b>	0.001 kg
Plastic green	RAL 6005	B		<b>96-931.5</b>	0.001 kg
Plastic grey	RAL 7012	B		<b>96-931.8</b>	0.001 kg
Plastic white		B		<b>98-931.9</b>	0.001 kg
 <p><b>Lens standard single square, 17.4 x 17.4 mm</b></p>					
Plastic black	RAL 9011	B	1	<b>96-932.0</b>	0.001 kg
Plastic red	RAL 3016	B	1	<b>96-932.2</b>	0.001 kg
Plastic green	RAL 6005	B	1	<b>96-932.5</b>	0.001 kg
Plastic grey	RAL 7012	B	1	<b>96-932.8</b>	0.001 kg
Plastic white		B	1	<b>98-932.9</b>	0.001 kg
 <p><b>Lens standard single square, 17.4 x 17.4 mm</b></p>					
Plastic black	RAL 9011	B	2	<b>96-933.0</b>	0.001 kg
Plastic red	RAL 3016	B	2	<b>96-933.2</b>	0.001 kg
Plastic green	RAL 6005	B	2	<b>98-933.5</b>	0.001 kg
Plastic grey	RAL 7012	B	2	<b>96-933.8</b>	0.001 kg
Plastic white		B	2	<b>98-933.9</b>	0.001 kg
 <p><b>Lens standard single square, 17.4 x 17.4 mm</b></p>					
Plastic black	RAL 9011	C		<b>96-935.0</b>	0.001 kg
Plastic red	RAL 3016	C		<b>96-935.2</b>	0.001 kg
Plastic green	RAL 6005	C		<b>96-935.5</b>	0.001 kg
Plastic grey	RAL 7012	C		<b>96-935.8</b>	0.001 kg
Plastic white		C		<b>98-935.9</b>	0.001 kg
 <p><b>Lens standard single square, 17.4 x 17.4 mm</b></p>					
Plastic black	RAL 9011	C	1	<b>96-936.0</b>	0.001 kg
Plastic red	RAL 3016	C	1	<b>96-936.2</b>	0.001 kg
Plastic green	RAL 6005	C	1	<b>96-936.5</b>	0.001 kg
Plastic grey	RAL 7012	C	1	<b>96-936.8</b>	0.001 kg
Plastic white		C	1	<b>98-936.9</b>	0.001 kg

Switching action: B = Momentary, C = Maintained



Lens	Colour	Switching action	Recess for LED	Part No.	Weight
 <p><b>Lens standard single square, 17.4 x 17.4 mm</b></p>					
Plastic black	RAL 9011	C	2	<b>96-937.0</b>	0.001 kg
Plastic red	RAL 3016	C	2	<b>96-937.2</b>	0.001 kg
Plastic green	RAL 6005	C	2	<b>96-937.5</b>	0.001 kg
Plastic grey	RAL 7012	C	2	<b>96-937.8</b>	0.001 kg
Plastic white		C	2	<b>98-937.9</b>	0.001 kg
 <p><b>Lens standard single rectangular, 14.8 x 17.4 mm</b></p>					
Plastic black	RAL 9011	B		<b>96-921.0</b>	0.001 kg
Plastic red	RAL 3016	B		<b>96-921.2</b>	0.001 kg
Plastic green	RAL 6005	B		<b>96-921.5</b>	0.001 kg
Plastic grey	RAL 7012	B		<b>96-921.8</b>	0.001 kg
Plastic white		B		<b>98-921.9</b>	0.001 kg
 <p><b>Lens standard single rectangular, 14.8 x 17.4 mm</b></p>					
Plastic black	RAL 9011	B	1	<b>96-922.0</b>	0.001 kg
Plastic red	RAL 3016	B	1	<b>96-922.2</b>	0.001 kg
Plastic green	RAL 6005	B	1	<b>96-922.5</b>	0.001 kg
Plastic grey	RAL 7012	B	1	<b>96-922.8</b>	0.001 kg
Plastic white		B	1	<b>98-922.9</b>	0.001 kg
 <p><b>Lens standard single rectangular, 14.8 x 17.4 mm</b></p>					
Plastic black	RAL 9011	B	2	<b>96-923.0</b>	0.001 kg
Plastic red	RAL 3016	B	2	<b>96-923.2</b>	0.001 kg
Plastic green	RAL 6005	B	2	<b>96-923.5</b>	0.001 kg
Plastic grey	RAL 7012	B	2	<b>96-923.8</b>	0.001 kg
Plastic white		B	2	<b>98-923.9</b>	0.001 kg
 <p><b>Lens standard single rectangular, 14.8 x 17.4 mm</b></p>					
Plastic black	RAL 9011	C		<b>96-925.0</b>	0.001 kg
Plastic red	RAL 3016	C		<b>96-925.2</b>	0.001 kg
Plastic green	RAL 6005	C		<b>96-925.5</b>	0.001 kg
Plastic grey	RAL 7012	C		<b>96-925.8</b>	0.001 kg
Plastic white		C		<b>98-925.9</b>	0.001 kg

Switching action: B = Momentary, C = Maintained



Lens	Colour	Switching action	Recess for LED	Part No.	Weight
 <p><b>Lens standard single rectangular, 14.8 x 17.4 mm</b></p>					
Plastic black	RAL 9011	C	1	<b>96-926.0</b>	0.001 kg
Plastic red	RAL 3016	C	1	<b>96-926.2</b>	0.001 kg
Plastic green	RAL 6005	C	1	<b>96-926.5</b>	0.001 kg
Plastic grey	RAL 7012	C	1	<b>96-926.8</b>	0.001 kg
Plastic white		C	1	<b>98-926.9</b>	0.001 kg
 <p><b>Lens standard single rectangular, 14.8 x 17.4 mm</b></p>					
Plastic black	RAL 9011	C	2	<b>96-927.0</b>	0.001 kg
Plastic red	RAL 3016	C	2	<b>96-927.2</b>	0.001 kg
Plastic green	RAL 6005	C	2	<b>96-927.5</b>	0.001 kg
Plastic grey	RAL 7012	C	2	<b>96-927.8</b>	0.001 kg
Plastic white		C	2	<b>98-927.9</b>	0.001 kg
 <p><b>Lens standard single rectangular, 12.4 x 17.4 mm</b></p>					
Plastic black	RAL 9011	B		<b>96-901.0</b>	0.001 kg
Plastic red	RAL 3016	B		<b>96-901.2</b>	0.001 kg
Plastic green	RAL 6005	B		<b>96-901.5</b>	0.001 kg
Plastic grey	RAL 7012	B		<b>96-901.8</b>	0.001 kg
Plastic white		B		<b>98-901.9</b>	0.001 kg
 <p><b>Lens standard single rectangular, 12.4 x 17.4 mm</b></p>					
Plastic black	RAL 9011	B	1	<b>96-902.0</b>	0.001 kg
Plastic red	RAL 3016	B	1	<b>96-902.2</b>	0.001 kg
Plastic green	RAL 6005	B	1	<b>96-902.5</b>	0.001 kg
Plastic grey	RAL 7012	B	1	<b>96-902.8</b>	0.001 kg
Plastic white		B	1	<b>98-902.9</b>	0.001 kg
 <p><b>Lens standard single rectangular, 12.4 x 17.4 mm</b></p>					
Plastic black	RAL 9011	B	2	<b>96-903.0</b>	0.001 kg
Plastic red	RAL 3016	B	2	<b>96-903.2</b>	0.001 kg
Plastic green	RAL 6005	B	2	<b>96-903.5</b>	0.001 kg
Plastic grey	RAL 7012	B	2	<b>96-903.8</b>	0.001 kg
Plastic white		B	2	<b>98-903.9</b>	0.001 kg

Switching action: B = Momentary, C = Maintained







Lens	Colour	Switching action	Recess for LED	Part No.	Weight
 <p><b>Lens standard single rectangular, 12.4 x 17.4 mm</b></p>					
Plastic black	RAL 9011	C		<b>96-905.0</b>	0.001 kg
Plastic red	RAL 3016	C		<b>96-905.2</b>	0.001 kg
Plastic green	RAL 6005	C		<b>96-905.5</b>	0.001 kg
Plastic grey	RAL 7012	C		<b>96-905.8</b>	0.001 kg
Plastic white		C		<b>98-905.9</b>	0.001 kg
 <p><b>Lens standard single rectangular, 12.4 x 17.4 mm</b></p>					
Plastic black	RAL 9011	C	1	<b>96-906.0</b>	0.001 kg
Plastic red	RAL 3016	C	1	<b>96-906.2</b>	0.001 kg
Plastic green	RAL 6005	C	1	<b>96-906.5</b>	0.001 kg
Plastic grey	RAL 7012	C	1	<b>96-906.8</b>	0.001 kg
Plastic white		C	1	<b>98-906.9</b>	0.001 kg
 <p><b>Lens standard single rectangular, 12.4 x 17.4 mm</b></p>					
Plastic black	RAL 9011	C	2	<b>96-907.0</b>	0.001 kg
Plastic red	RAL 3016	C	2	<b>96-907.2</b>	0.001 kg
Plastic green	RAL 6005	C	2	<b>96-907.5</b>	0.001 kg
Plastic grey	RAL 7012	C	2	<b>96-907.8</b>	0.001 kg
Plastic white		C	2	<b>98-907.9</b>	0.001 kg

**Lens standard single for film insert**

Lens	Colour	Switching action	Recess for LED	Part No.	Weight
 <p><b>Lens standard single for film insert square, 17.4 x 17.4 mm</b></p>					
Plastic black	RAL 9011	B		<b>96-941.0</b>	0.001 kg
Plastic red	RAL 3016	B		<b>96-941.2</b>	0.001 kg
Plastic green	RAL 6005	B		<b>96-941.5</b>	0.001 kg
Plastic grey	RAL 7012	B		<b>96-941.8</b>	0.001 kg
Plastic white		B		<b>98-941.9</b>	0.001 kg
 <p><b>Lens standard single for film insert square, 17.4 x 17.4 mm</b></p>					
Plastic black	RAL 9011	B	1	<b>96-942.0</b>	0.001 kg
Plastic red	RAL 3016	B	1	<b>96-942.2</b>	0.001 kg
Plastic green	RAL 6005	B	1	<b>96-942.5</b>	0.001 kg
Plastic grey	RAL 7012	B	1	<b>96-942.8</b>	0.001 kg
Plastic white		B	1	<b>98-942.9</b>	0.001 kg

Switching action: B = Momentary, C = Maintained

Lens	Colour	Switching action	Recess for LED	Part No.	Weight
 <p><b>Lens standard single for film insert square, 17.4 x 17.4 mm</b></p>					
Plastic black	RAL 9011	B	2	<b>96-943.0</b>	0.001 kg
Plastic red	RAL 3016	B	2	<b>96-943.2</b>	0.001 kg
Plastic green	RAL 6005	B	2	<b>96-943.5</b>	0.001 kg
Plastic grey	RAL 7012	B	2	<b>98-943.8</b>	0.001 kg
Plastic white		B	2	<b>98-943.9</b>	0.001 kg
 <p><b>Lens standard single for film insert square, 17.4 x 17.4 mm</b></p>					
Plastic black	RAL 9011	C		<b>96-945.0</b>	0.001 kg
Plastic red	RAL 3016	C		<b>96-945.2</b>	0.001 kg
Plastic green	RAL 6005	C		<b>96-945.5</b>	0.001 kg
Plastic grey	RAL 7012	C		<b>96-945.8</b>	0.001 kg
Plastic white		C		<b>98-945.9</b>	0.001 kg
 <p><b>Lens standard single for film insert square, 17.4 x 17.4 mm</b></p>					
Plastic black	RAL 9011	C	1	<b>96-946.0</b>	0.001 kg
Plastic red	RAL 3016	C	1	<b>96-946.2</b>	0.001 kg
Plastic green	RAL 6005	C	1	<b>96-946.5</b>	0.001 kg
Plastic grey	RAL 7012	C	1	<b>96-946.8</b>	0.001 kg
Plastic white		C	1	<b>98-946.9</b>	0.001 kg
 <p><b>Lens standard single for film insert square, 17.4 x 17.4 mm</b></p>					
Plastic black	RAL 9011	C	2	<b>96-947.0</b>	0.001 kg
Plastic red	RAL 3016	C	2	<b>96-947.2</b>	0.001 kg
Plastic green	RAL 6005	C	2	<b>96-947.5</b>	0.001 kg
Plastic grey	RAL 7012	C	2	<b>96-947.8</b>	0.001 kg
Plastic white		C	2	<b>98-947.9</b>	0.001 kg

Switching action: B = Momentary, C = Maintained

Illumination

**Single-LED standard**

**Additional Information**

- Without serie resistor, with special pin crank

LED colour	Operating voltage	Operation current	Part No.	Weight
 <p><b>Single-LED standard</b></p>				
Single-LED red	2.2 VDC	20 mA	<b>10-2602.3172E</b>	0.001 kg
Single-LED yellow	2.2 VDC	20 mA	<b>10-2602.3174E</b>	0.001 kg
Single-LED green	2.2 VDC	20 mA	<b>10-2602.3175E</b>	0.001 kg

# 96 Accessories

Mounting

## Lens remover

Part No.	Weight
 <p data-bbox="247 564 411 593"><b>Lens remover</b></p>	
98-968	0.004 kg

Drawings

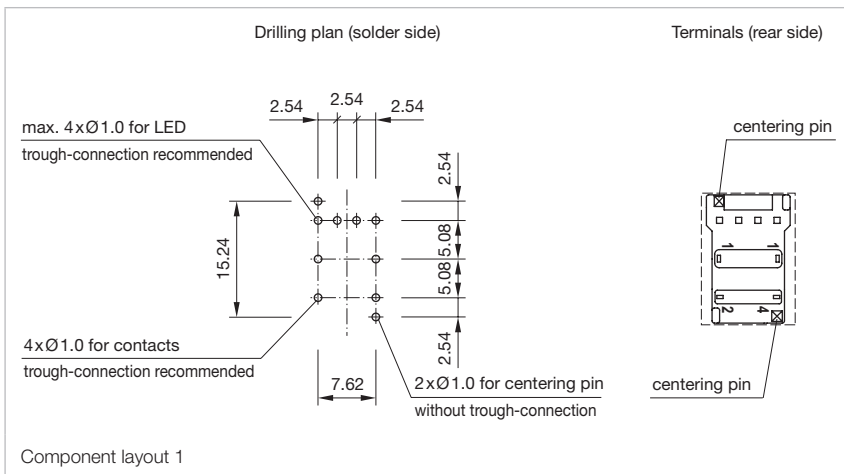

## Snap-action switching element

### Switching system

Single-break, self-cleaning, snap-action switching element with tactile feel of operation.

### Material

#### Lens Euro-Style

ABS/PC or ABS, self-extinguishing

#### Housing

Polyester, self-extinguishing

#### Material of contact

Gold-plated on nickel

### Mechanical characteristics

#### Terminals

PCB terminal

#### Actuating force

Actuating force 1.4 N  $\pm$ 0.3 N

#### Actuating travel

Lead distance 1.0 mm  $\pm$ 0.3 mm

Total distance 1.7 mm  $\pm$ 0.5 mm

#### Mechanical lifetime

$\geq$ 5 million operations, as per IEC 60512-5-9a

#### Rebound time

$\leq$ 2.5 ms

### Electrical characteristics

#### Contact resistance

Starting value (initial)  $\leq$ 100 m $\Omega$ , as per IEC 60512-2-2b

#### Isolation resistance

$\geq$ 1012  $\Omega$  between contacts at 100 VDC, as per IEC 60512-2-3a

#### Capacity

Between contacts  $\leq$ 1 pF

#### Electrical life

$\geq$ 5 x 100.000 operations at 30 VDC, 100 mA, as per IEC 60512-5, test 9c

#### Conventional free air thermal current $I_{th2}$

100 mA

#### Switch rating

Electric strength

500 VAC, 50 Hz, 1 min. between all terminals and earth, as per IEC 60512-2-11

### Environmental conditions

#### Storage temperature

-40 °C ... +85 °C

#### Service temperature

-25 °C ... +85 °C

#### Front protection

IP 67, as per IEC 60529

#### Shock resistance

(single impacts, semi-sinusoidal)

$\geq$ 30 g for 11 ms as per IEC 60512-4-3

#### Vibration resistance

(sinusoidal)

10 g at 10 Hz ... 2000 Hz, amplitude 0.75 mm, as per IEC 60512-4-4

EAO reserves the right to alter specifications without further notice.

## General notes

### 1. Engraving

In addition to the most commonly used world languages, in DIN1451-3 close spacing, other typefaces are available as Scandinavian, Slavic, Greek, Russian and Polish. Red, blue and black lenses are filled with white colour. Other colour lenses are filled in black. Standard height of letters is 2mm. If the height is not specified, we will supply 2mm engraved letters.

### 2. Hot stamping

On request. We will be pleased to advise you.

### 3. Film inserts

A special lens, 17.4 x 17.4 mm, available for insertion of a colour foil or film. The film thickness is 0.2mm.

## Lenses standard

All dimensions in mm

Front size	Film insert max. size	Height of letters h	Labeling field A			Labeling field B			Image
			Number of lines	Number of capital letters per line (target value)	Number of small letters per line (target value)	Number of lines	Number of capital letters per line (target value)	Number of small letters per line (target value)	
12.4 x 17.4		2	1	6	6-7	2	5	6-7	B1
		3	1	4	5	2	4	4-5	B1
		4	1	3-4	4	1	3-4	4	B1
		5				1	2-3	3	B1
		6				1	2	2	B1
		8				1	1	1	B1
14.8 x 17.4		2	1	7	7-8	2	6	7-8	B2
		3	1	5-6	6-7	2	5	6	B2
		4	1	4	4-5	1	4	4	B2
		5				1	3	3-4	B2
		6				1	2-3	3	B2
		8				1	1-3	2	B2
17.4 x 17.4	7 x 12	2	1	8-9	9-10	2	7-8	8-9	B3
		2	1	8-9	9-10				B4
		3	1	7-8	8-9	2	6-7	7-8	B3
		3	1	7-8	8-9				B4
		4	1	5	5-6	1	4-5	5-6	B3
		4	1	5	5-6				B4
		5				1	3-4	4	B3
									B4
		6				1	2-3	3	B3
									B4
		8				1	2	2-3	B3
									B4

B1

B2

B3

B4

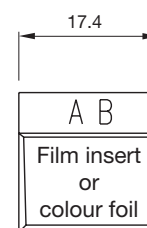
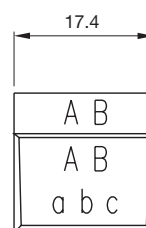
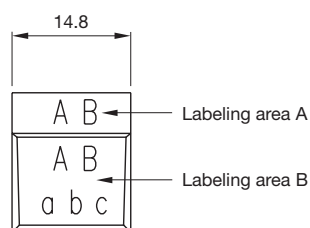
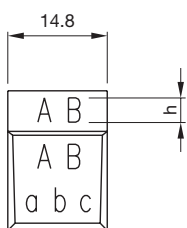

## Suppressor circuits

When switching inductive loads such as relays, DC motors, and DC solenoids, it is always important to absorb surges (e.g. with a diode) to protect the contacts. When these inductive loads are switched off, a counter emf can severely damage switch contacts and greatly shorten lifetime.

Fig. 1 shows an inductive load with a free-wheeling diode connected in parallel. This free-wheeling diode provides a path for the inductor current to flow when the current is interrupted by the switch. Without this free-wheeling diode, the voltage across the coil will be limited only by dielectric breakdown voltages of the circuit or parasitic elements of the coil. This voltage can be kilovolts in amplitude even when nominal circuit voltages are low (e.g. 12VDC) see Fig. 2.

The free-wheeling diode should be chosen so that the reverse breakdown voltage is greater than the voltage driving the inductive load. The DC blocking voltage (VR) of the free-wheeling diode can be found in the datasheet of a diode. The forward current should be equal or greater than the maximum current flowing through the load.

**To get an efficient protection, the free-wheeling diode must be connected as close as possible to the inductive load!**

Switching with inductive load  
Fig. 1

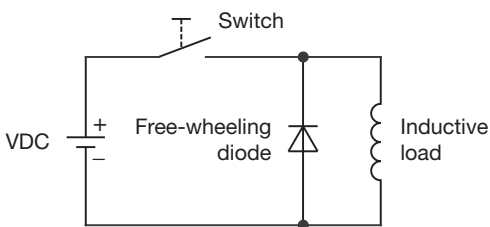

Counter EMF  
over load without free-wheeling diode  
Fig. 2

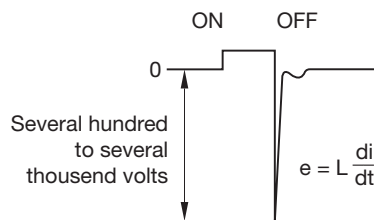



## Index from Part No.

Part No.	Page	Part No.	Page
10-2602.3172E	11	96-941.5	9
10-2602.3174E	11	96-941.8	9
10-2602.3175E	11	96-942.0	9
96-323.837	4	96-942.2	9
96-901.0	8	96-942.5	9
96-901.2	8	96-942.8	9
96-901.5	8	96-943.0	10
96-901.8	8	96-943.2	10
96-902.0	8	96-943.5	10
96-902.2	8	96-945.0	10
96-902.5	8	96-945.2	10
96-902.8	8	96-945.5	10
96-903.0	8	96-945.8	10
96-903.2	8	96-946.0	10
96-903.5	8	96-946.2	10
96-903.8	8	96-946.5	10
96-905.0	9	96-946.8	10
96-905.2	9	96-947.0	10
96-905.5	9	96-947.2	10
96-905.8	9	96-947.5	10
96-906.0	9	96-947.8	10
96-906.2	9	98-901.9	8
96-906.5	9	98-902.9	8
96-906.8	9	98-903.9	8
96-907.0	9	98-905.9	9
96-907.2	9	98-906.9	9
96-907.5	9	98-907.9	9
96-907.8	9	98-921.9	7
96-921.0	7	98-922.9	7
96-921.2	7	98-923.9	7
96-921.5	7	98-925.9	7
96-921.8	7	98-926.9	8
96-922.0	7	98-927.9	8
96-922.2	7	98-931.9	6
96-922.5	7	98-932.9	6
96-922.8	7	98-933.5	6
96-923.0	7	98-933.9	6
96-923.2	7	98-935.9	6
96-923.5	7	98-936.9	6
96-923.8	7	98-937.9	7
96-925.0	7	98-941.9	9
96-925.2	7	98-942.9	9
96-925.5	7	98-943.8	10
96-925.8	7	98-943.9	10
96-926.0	8	98-945.9	10
96-926.2	8	98-946.9	10
96-926.5	8	98-947.9	10
96-926.8	8	98-968	12
96-927.0	8		
96-927.2	8		
96-927.5	8		
96-927.8	8		
96-931.0	6		
96-931.2	6		
96-931.5	6		
96-931.8	6		
96-932.0	6		
96-932.2	6		
96-932.5	6		
96-932.8	6		
96-933.0	6		
96-933.2	6		
96-933.8	6		
96-935.0	6		
96-935.2	6		
96-935.5	6		
96-935.8	6		
96-936.0	6		
96-936.2	6		
96-936.5	6		
96-936.8	6		
96-937.0	7		
96-937.2	7		
96-937.5	7		
96-937.8	7		
96-941.0	9		
96-941.2	9		





## Стандарт Электрон Связь

Мы молодая и активно развивающаяся компания в области поставок электронных компонентов. Мы поставляем электронные компоненты отечественного и импортного производства напрямую от производителей и с крупнейших складов мира.

Благодаря сотрудничеству с мировыми поставщиками мы осуществляем комплексные и плановые поставки широчайшего спектра электронных компонентов.

Собственная эффективная логистика и склад в обеспечивает надежную поставку продукции в точно указанные сроки по всей России.

Мы осуществляем техническую поддержку нашим клиентам и предпродажную проверку качества продукции. На все поставляемые продукты мы предоставляем гарантию .

Осуществляем поставки продукции под контролем ВП МО РФ на предприятия военно-промышленного комплекса России , а также работаем в рамках 275 ФЗ с открытием отдельных счетов в уполномоченном банке. Система менеджмента качества компании соответствует требованиям ГОСТ ISO 9001.

Минимальные сроки поставки, гибкие цены, неограниченный ассортимент и индивидуальный подход к клиентам являются основой для выстраивания долгосрочного и эффективного сотрудничества с предприятиями радиоэлектронной промышленности, предприятиями ВПК и научно-исследовательскими институтами России.

С нами вы становитесь еще успешнее!

### Наши контакты:

**Телефон:** +7 812 627 14 35

**Электронная почта:** [sales@st-electron.ru](mailto:sales@st-electron.ru)

**Адрес:** 198099, Санкт-Петербург,  
Промышленная ул, дом № 19, литера Н,  
помещение 100-Н Офис 331