

**MAXIM**

# Dual, 8-Bit, Voltage-Output Serial DAC in 8-Pin SOT23

**MAX5222**

## General Description

The MAX5222 contains two 8-bit, buffered, voltage-output digital-to-analog converters (DAC A and DAC B) in a small 8-pin SOT23 package. Both DAC outputs can source and sink 1mA to within 100mV of ground and  $V_{DD}$ . The MAX5222 operates with a single +2.7V to +5.5V supply.

The device uses a 3-wire serial interface, which operates at clock rates up to 25MHz and is compatible with SPI™, QSPI™, and MICROWIRE™ interface standards. The serial input shift register is 16 bits long and consists of 8 bits of DAC input data and 8 bits for DAC selection and shutdown control. DAC registers can be loaded independently or in parallel at the positive edge of CS.

The MAX5222's ultra-low power consumption and tiny 8-pin SOT23 package make it ideal for portable and battery-powered applications. Supply current is less than 1mA and drops below 1 $\mu$ A in shutdown mode. In addition, the reference input is disconnected from the REF pin during shutdown, further reducing the system's total power consumption.

## Applications

- Digital Gain and Offset Adjustment
- Programmable Current Source
- Programmable Voltage Source
- Power-Amp Bias Control
- VCO Tuning

## Pin Configuration

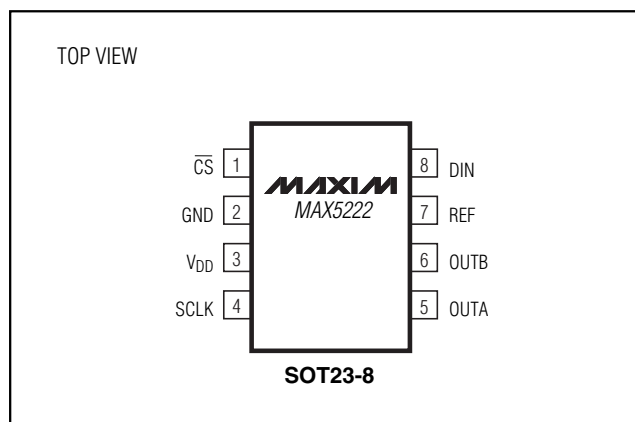

SPI and QSPI are trademarks of Motorola, Inc.

MICROWIRE is a trademark of National Semiconductor Corp.

## Features

- ◆ Operates from a Single +2.7V to +5.5V Supply
- ◆ Tiny 8-Pin SOT23 Package (3mm × 3mm)
- ◆ Dual Buffered Voltage Output
- ◆ Low Power Consumption
  - 0.4mA Operating Current
  - <1 $\mu$ A Shutdown Current
- ◆ Programmable Shutdown Mode
- ◆ 25MHz, 3-Wire Serial Interface
- ◆ SPI, QSPI, and MICROWIRE Compatible

## Ordering Information

PART	TEMP. RANGE	PIN-PACKAGE
MAX5222EKA-T	-40°C to +85°C	8 SOT23-8

## Functional Diagram

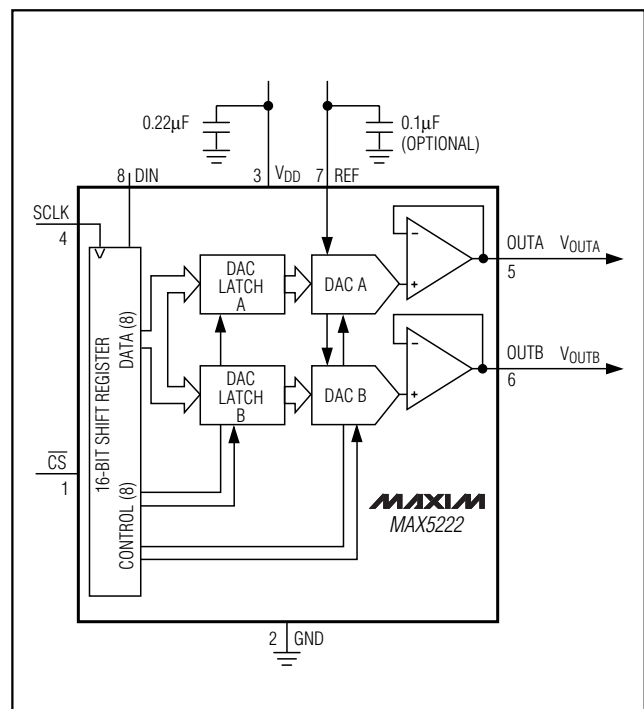
**MAXIM**

Maxim Integrated Products 1

For free samples and the latest literature, visit [www.maxim-ic.com](http://www.maxim-ic.com) or phone 1-800-998-8800.  
For small orders, phone 1-800-835-8769.

# Dual, 8-Bit, Voltage-Output Serial DAC in 8-Pin SOT23

## ABSOLUTE MAXIMUM RATINGS

V <sub>DD</sub> to GND .....	-0.3V to +6V	Operating Temperature Range .....	-40°C to +85°C
All Other Pins to GND (Note 1).....	-0.3V to (V <sub>DD</sub> + 0.3V)	Junction Temperature .....	+150°C
Continuous Power Dissipation (T <sub>A</sub> = +70°C)		Storage Temperature Range .....	-65°C to +150°C
8-Pin SOT23 (derate 8.7mW/°C above +70°C).....	696mW	Lead Temperature (soldering, 10s) .....	+300°C

**Note 1:** The outputs may be shorted to V<sub>DD</sub> or GND if the package power dissipation is not exceeded. Typical short-circuit current to GND is 70mA.

Stresses beyond those listed under "Absolute Maximum Ratings" may cause permanent damage to the device. These are stress ratings only, and functional operation of the device at these or any other conditions beyond those indicated in the operational sections of the specifications is not implied. Exposure to absolute maximum rating conditions for extended periods may affect device reliability.

## ELECTRICAL CHARACTERISTICS

(V<sub>DD</sub> = +2.7V to +5.5V, REF = V<sub>DD</sub>, T<sub>A</sub> = T<sub>MIN</sub> to T<sub>MAX</sub>, unless otherwise noted. Typical values are at T<sub>A</sub> = +25°C.)

PARAMETER	SYMBOL	CONDITIONS	MIN	TYP	MAX	UNITS
<b>STATIC PERFORMANCE</b>						
Resolution	N		8			Bits
Differential Nonlinearity	DNL	Guaranteed monotonic		±0.3	±1	LSB
Integral Nonlinearity	INL	(Note 2)		±0.3	±1	LSB
Total Unadjusted Error	TUE	(Note 2)		±1		LSB
Zero-Code Offset	V <sub>ZS</sub>			10		mV
Zero-Code Temperature Coefficient	TC <sub>VZS</sub>			100		µV/°C
Power-Supply Rejection Ratio	PSRR	4.5V ≤ V <sub>DD</sub> ≤ 5.5V, V <sub>REF</sub> = 4.096V		0.15		mV/V
		2.7V ≤ V <sub>DD</sub> ≤ 3.6V, V <sub>REF</sub> = 2.4V		0.5		
<b>REFERENCE INPUT</b>						
Reference Input Voltage Range			GND		V <sub>DD</sub>	V
Reference Input Capacitance				25		pF
Reference Input Resistance	R <sub>REF</sub>	(Note 3)	8	16		kΩ
Reference Input Resistance (Shutdown Mode)				2		MΩ
<b>DAC OUTPUTS</b>						
Output Voltage Range			0		REF	V
Capacitive Load at OUT <sub>-</sub>					100	pF
Output Resistance				50		Ω
<b>DIGITAL INPUTS</b>						
Input High Voltage	V <sub>IH</sub>		0.7 × V <sub>DD</sub>			V
Input Low Voltage	V <sub>IL</sub>			0.3 × V <sub>DD</sub>		V
Input Current	I <sub>IN</sub>	V <sub>IN</sub> = 0 or V <sub>DD</sub>		0.1	±10	µA
Input Capacitance	C <sub>IN</sub>	(Note 4)			10	pF

# Dual, 8-Bit, Voltage-Output Serial DAC in 8-Pin SOT23

MAX5222

## ELECTRICAL CHARACTERISTICS (continued)

( $V_{DD} = +2.7V$  to  $+5.5V$ ,  $REF = V_{DD}$ ,  $T_A = T_{MIN}$  to  $T_{MAX}$ , unless otherwise noted. Typical values are at  $T_A = +25^{\circ}C$ .)

PARAMETER	SYMBOL	CONDITIONS	MIN	TYP	MAX	UNITS
<b>DYNAMIC PERFORMANCE</b>						
Voltage-Output Slew Rate	SR	$C_L = 100pF$		1		V/ $\mu s$
Voltage-Output Settling Time		To $\pm 1/2$ LSB, $C_L = 100pF$		10		$\mu s$
Digital Feedthrough and Crosstalk		All 0s to all 1s		0.25		nV-s
<b>POWER SUPPLY</b>						
Supply Voltage Range	$V_{DD}$		2.7		5.5	V
Supply Current	$I_{DD}$	All inputs = 0	$V_{DD} = 5.5V$	0.55	1	mA
			$V_{DD} = 3.6V$	0.38	0.8	
Shutdown Supply Current		$V_{DD} = 5.5V$		0.1		$\mu A$

## TIMING CHARACTERISTICS

(Figure 3,  $V_{DD} = +2.7V$  to  $+5.5V$ ,  $T_A = T_{MIN}$  to  $T_{MAX}$ , unless otherwise noted.) (Note 4)

PARAMETER	SYMBOL	CONDITIONS	MIN	TYP	MAX	UNITS
<b>SERIAL INTERFACE TIMING</b>						
$\overline{CS}$ Fall to SCLK Rise Setup Time	$t_{CSS}$		50			ns
SCLK Rise to $\overline{CS}$ Rise Setup Time	$t_{CSH}$		50			ns
DIN to SCLK Rise Setup Time	$t_{DS}$		20			ns
DIN to SCLK Rise Hold Time	$t_{DH}$		20			ns
SCLK Pulse Width High	$t_{CH}$		20			ns
SCLK Pulse Width Low	$t_{CL}$		20			ns
$\overline{CS}$ Pulse Width High	$t_{CSPWH}$		50			ns

**Note 2:** Reduced digital code range (code 24 through code 232) is due to swing limitations of the output amplifiers. See *Typical Operating Characteristics*.

**Note 3:** Reference input resistance is code dependent. The lowest input resistance occurs at code 55hex. See the *Reference Input* section.

**Note 4:** Guaranteed by design. Not production tested.

# Dual, 8-Bit, Voltage-Output Serial DAC in 8-Pin SOT23

## Typical Operating Characteristics

( $V_{DD} = +3V$ ,  $T_A = +25^\circ C$ , unless otherwise noted.)

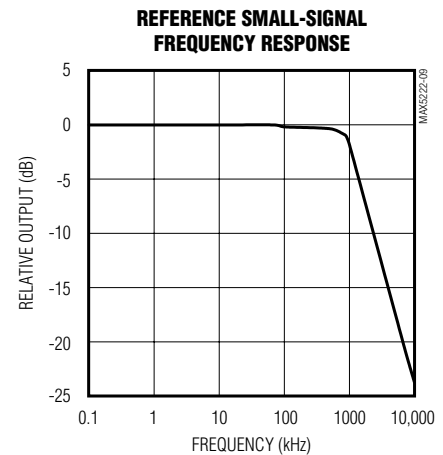
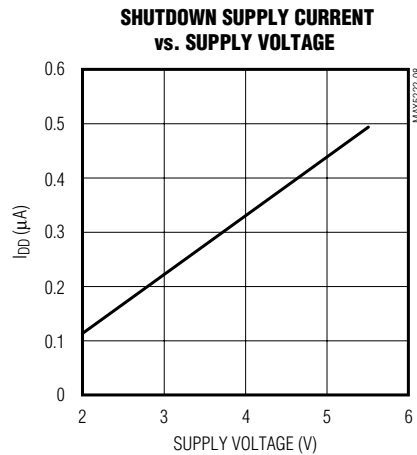
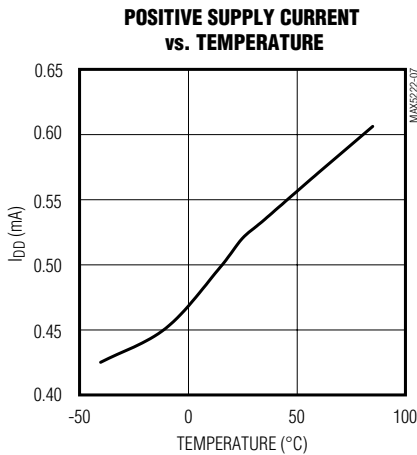
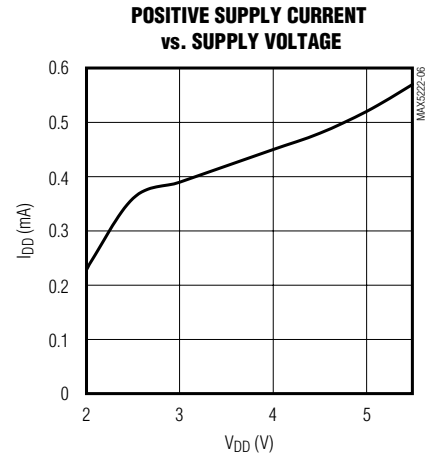
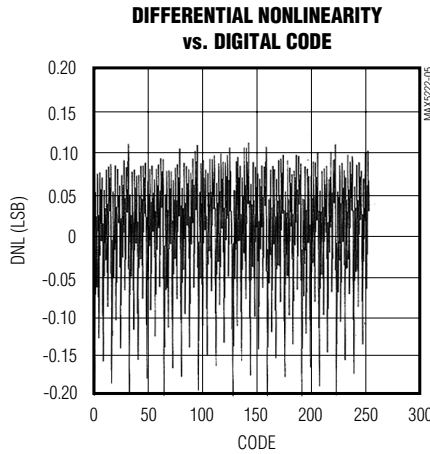
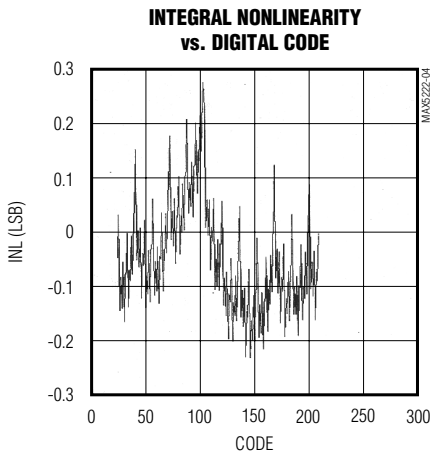
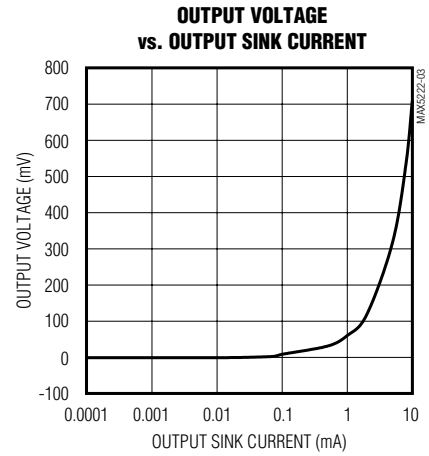
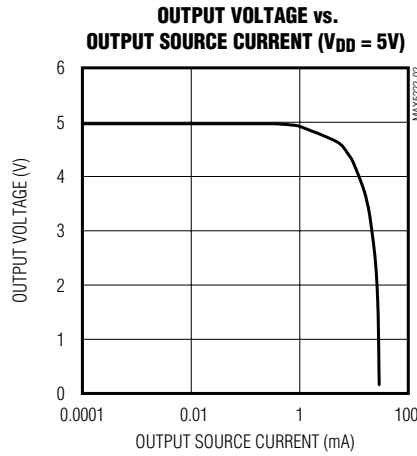
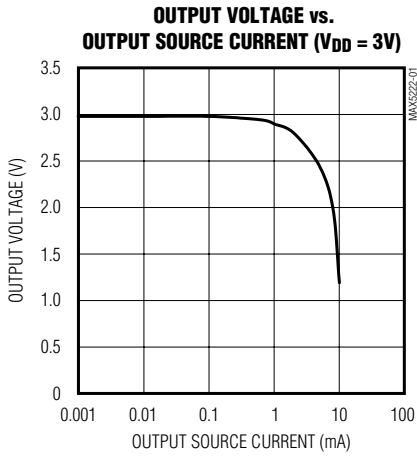

# Dual, 8-Bit, Voltage-Output Serial DAC in 8-Pin SOT23

MAX5222

## Typical Operating Characteristics (continued)

( $V_{DD} = +3V$ ,  $T_A = +25^\circ C$ , unless otherwise noted.)

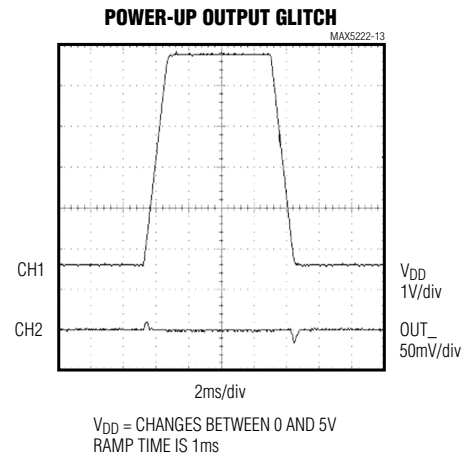
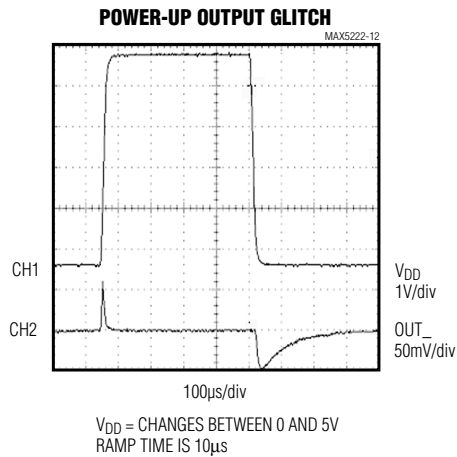
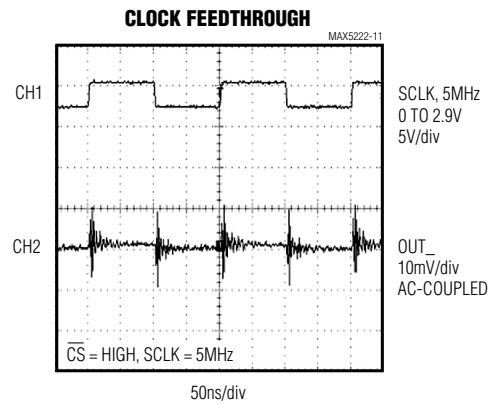
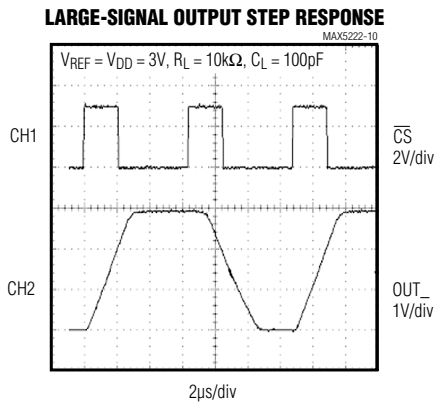

# Dual, 8-Bit, Voltage-Output Serial DAC in 8-Pin SOT23

## Typical Operating Characteristics (continued)

( $V_{DD} = +3V$ ,  $T_A = +25^\circ C$ , unless otherwise noted.)

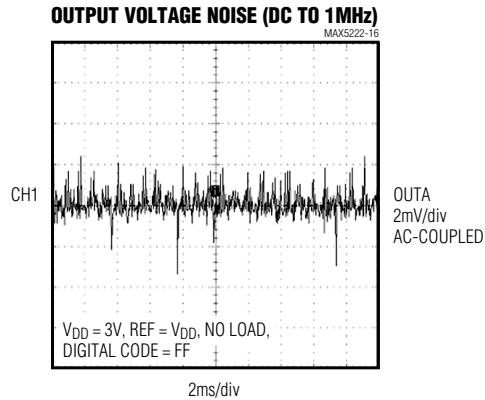
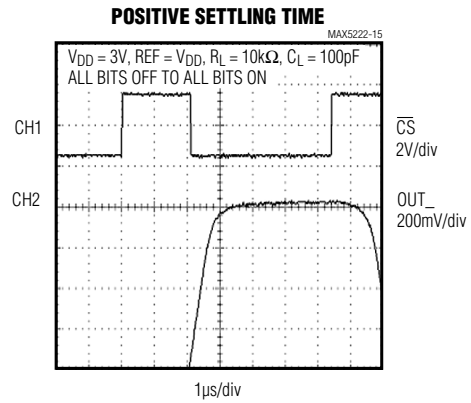
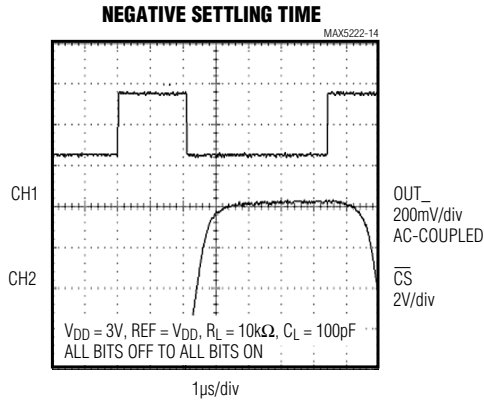

# Dual, 8-Bit, Voltage-Output Serial DAC in 8-Pin SOT23

MAX5222

## Pin Description

PIN	NAME	FUNCTION
1	$\overline{CS}$	Chip Select, Active Low. Enables data to be shifted into the 16-bit shift register. Programming commands are executed at the rising edge of $\overline{CS}$ .
2	GND	Ground
3	V <sub>DD</sub>	Positive Power Supply (+2.7V to +5.5V). Bypass with 0.22μF to GND.
4	SCLK	Serial Clock Input. Data is clocked in on the rising edge of SCLK.
5	OUTA	DAC A Output Voltage (Buffered)
6	OUTB	DAC B Output Voltage (Buffered)
7	REF	Reference Input for DAC A and DAC B
8	DIN	Serial Data Input of the 16-bit Shift Register. Data is clocked into the register on the rising edge of SCLK.

## Detailed Description

### Analog Section

The MAX5222 contains two 8-bit, voltage-output DACs. The DACs are “inverted” R-2R ladder networks using complementary switches that convert 8-bit digital inputs into equivalent analog output voltages in proportion to the applied reference voltage.

The MAX5222 has one reference input that is shared by DAC A and DAC B. The device includes output buffer amplifiers for both DACs and input logic for simple microprocessor (μP) and CMOS interfaces. The power-supply range is from +5.5V down to +2.7V.

### Reference Input and DAC Output Range

The voltage at REF sets the full-scale output of the DACs. The input impedance of the REF input is code dependent. The lowest value, approximately 8kΩ, occurs when the input code is 01010101 (55hex). The maximum value of infinity occurs when the input code is zero.

In shutdown mode, the selected DAC output is set to zero, while the value stored in the DAC register remains unchanged. This removes the load from the reference input to save power. Bringing the MAX5222 out of shutdown mode restores the DAC output voltage. Because the input resistance at REF is code dependent, the DAC’s reference source should have an output impedance of no more than 5Ω. The input capacitance at the

REF pin is also code dependent and typically does not exceed 25pF.

The reference voltage on REF can range anywhere from GND to V<sub>DD</sub>. See the *Output Buffer Amplifier* section for more information.

Figure 1 is the DAC simplified circuit diagram.

### Output Buffer Amplifiers

DAC A and DAC B voltage outputs are internally buffered. The buffer amplifiers have a Rail-to-Rail® (GND to V<sub>DD</sub>) output voltage range.

Both DAC output amplifiers can source and sink up to 1mA of current. See the INL vs. Digital Code graph in the *Typical Operating Characteristics*. The amplifiers are unity-gain stable with a capacitive load of 100pF or smaller. The slew rate is typically 1V/μs.

### Shutdown Mode

When programmed to shutdown mode, the outputs of DAC A and DAC B are passively pulled to GND with a series 5kΩ resistor. In shutdown mode, the REF input is high impedance (2MΩ typical) to conserve current drain from the system reference; therefore, the system reference does not have to be powered down.

Coming out of shutdown, the DAC outputs return to the values kept in the registers. The recovery time is equivalent to the DAC settling time.

*Rail-to-Rail is a registered trademark of Nippon Motorola, Ltd.*

# Dual, 8-Bit, Voltage-Output Serial DAC in 8-Pin SOT23

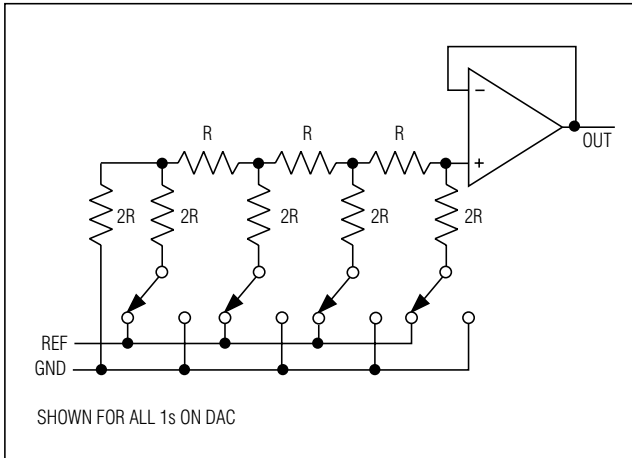

Figure 1. DAC Simplified Circuit Diagram

## Serial Interface

An active-low chip select ( $\overline{CS}$ ) enables the shift register to receive data from the serial data input. Data is clocked into the shift register on every rising edge of the serial clock signal (SCLK). The clock frequency can be as high as 25MHz.

Data is sent most significant bit (MSB) first and can be transmitted in one 16-bit word. The write cycle can be segmented when  $\overline{CS}$  is kept active (low) to allow, for example, two 8-bit-wide transfers. After clocking all 16 bits into the input shift register, the rising edge of  $\overline{CS}$  updates the DAC outputs and the shutdown status. Because of their single buffered structure, DACs cannot be simultaneously updated to different digital values.

Table 1. Input Shift Register

DATA BITS	B0*	DAC Data Bit 0 (LSB)
	B1	DAC Data Bit 1
	B2	DAC Data Bit 2
	B3	DAC Data Bit 3
	B4	DAC Data Bit 4
	B5	DAC Data Bit 5
	B6	DAC Data Bit 6
	B7	DAC Data Bit 7 (MSB)
CONTROL BITS	LA	Load Reg DAC A, Active High
	LB	Load Reg DAC B, Active High
	UB4	Uncommitted Bit 4
	SA	Shut Down, Active High
	SB	Shut Down, Active High
	UB3	Uncommitted Bit 3
	UB2	Uncommitted Bit 2
	UB1**	Uncommitted Bit 1

\*Clocked in last.

\*\*Clocked in first.

## Serial-Input Data Format and Control Codes

Table 2 lists the serial-input data format. The 16-bit input word consists of an 8-bit control byte and an 8-bit data byte. The 8-bit control byte is not decoded internally. Every control bit performs one function. Data is clocked in starting with UB1 (uncommitted bit), followed by the remaining control bits and the data byte. The least significant bit (LSB) of the data byte (B0) is the last bit clocked into the shift register (Figure 2).

Table 3 is an example of a 16-bit input word. It performs the following functions:

- 80 hex (128 decimal) loaded into DAC registers A and B.
- DAC A and DAC B are active.



# Dual, 8-Bit, Voltage-Output Serial DAC in 8-Pin SOT23

MAX5222

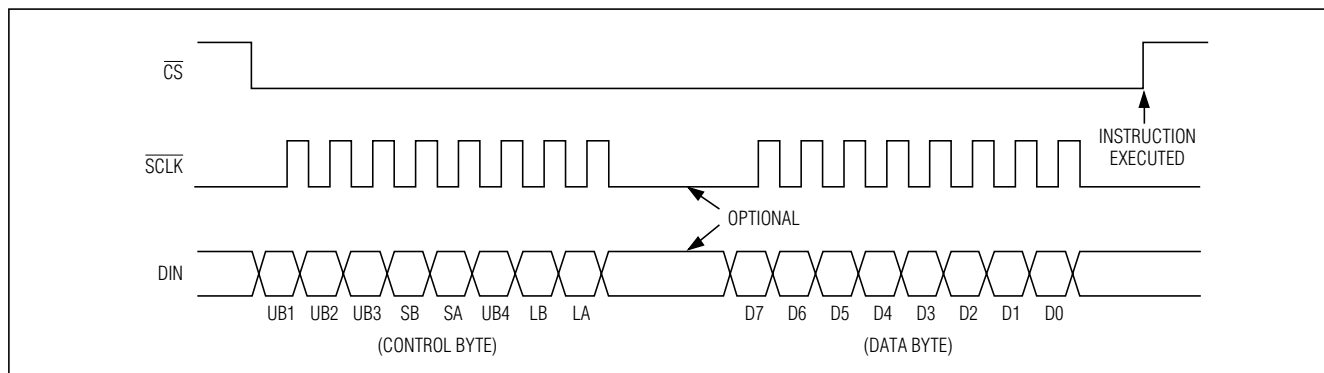

Figure 2. 3-Wire Serial-Interface Timing Diagram

**Table 2. Serial-Interface Programming Commands**

CONTROL								DATA								FUNCTION
UB1	UB2	UB3	SB	SA	UB4	LB	LA	B7 MSB	B6	B5	B4	B3	B2	B1	B0 LSB	
X	X	1	*	*	0	0	0	X	X	X	X	X	X	X	X	No Operation to DAC Registers
X	X	1	*	*	0	0	0									Unassigned Command
X	X	1	*	*	0	1	0	8-Bit DAC Data								Load Register to DAC B
X	X	1	*	*	0	0	1	8-Bit DAC Data								Load Register to DAC A
X	X	1	*	*	0	1	1	8-Bit DAC Data								Load Both DAC Registers
X	X	1	0	0	0	*	*	X	X	X	X	X	X	X	X	All DACs Active
X	X	1	0	0	0	*	*	X	X	X	X	X	X	X	X	Unassigned Command
X	X	1	1	0	0	*	*	X	X	X	X	X	X	X	X	Shut Down
X	X	1	0	1	0	*	*	X	X	X	X	X	X	X	X	Shut Down
X	X	1	1	1	0	*	*	X	X	X	X	X	X	X	X	Shut Down

X = Don't care.

\* = Not shown, for the sake of clarity. The functions of loading and shutting down the DACs and programming the logic can be combined in a single command.

**Table 3. Example of a 16-Bit Input Word**

LOADED IN FIRST									LOADED IN LAST							
UB1	UB2	UB3	SB	SA	UB4	LB	LA	B7	B6	B5	B4	B3	B2	B1	B0	
X	X	1	0	0	0	1	1	1	0	0	0	0	0	0	0	

# Dual, 8-Bit, Voltage-Output Serial DAC in 8-Pin SOT23

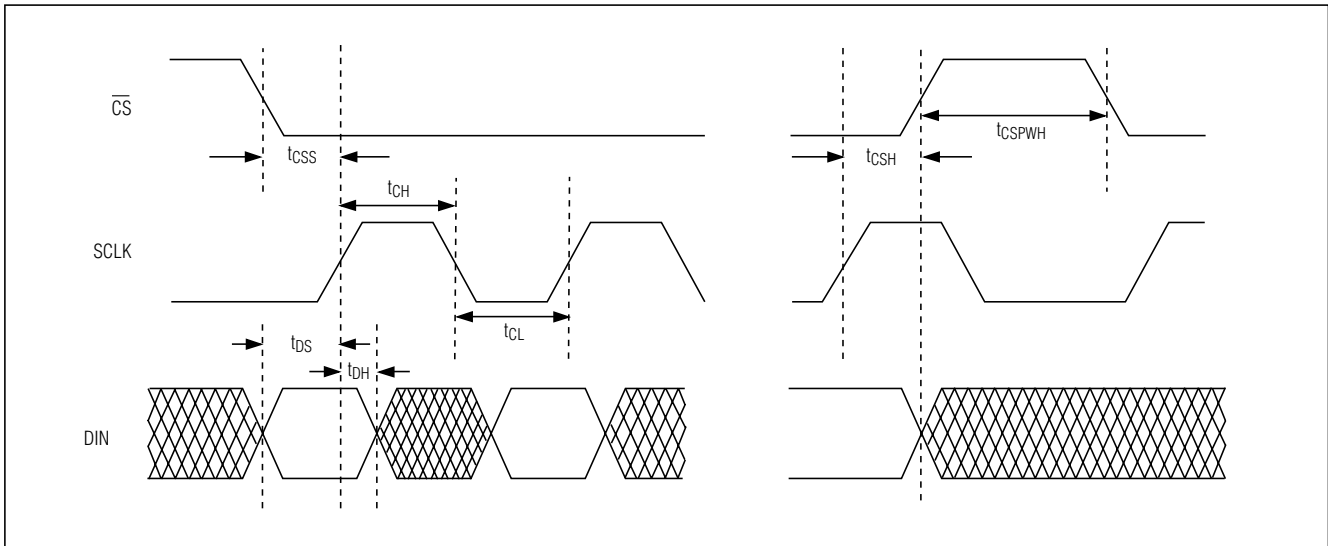

Figure 3. Detailed Serial-Interface Timing Diagram

### Digital Inputs

The digital inputs are compatible with CMOS logic. Supply current increases slightly when toggling the logic inputs through the transition zone between  $0.3 \times V_{DD}$  and  $0.7 \times V_{DD}$ .

### Microprocessor Interfacing

The MAX5222 serial interface is compatible with MICROWIRE, SPI, and QSPI. For SPI, clear the CPOL and CPHA bits (CPOL = 0 and CPHA = 0). CPOL = 0 sets the inactive clock state to zero, and CPHA = 0 changes data at the falling edge of SCLK. This setting allows SPI to run at full clock speeds. If a serial port is not available on your  $\mu P$ , 3 bits of a parallel port can be used to emulate a serial port by bit manipulation. Minimize digital feedthrough at the voltage outputs by operating the serial clock only when necessary.

Table 4. Code Table

DAC CONTENTS								ANALOG OUTPUT
B7	B6	B5	B4	B3	B2	B1	B0	
1	1	1	1	1	1	1	1	$+REF \times \left(\frac{255}{256}\right)$
1	0	0	0	0	0	0	1	$+REF \times \left(\frac{129}{256}\right)$
1	0	0	0	0	0	0	0	$+REF \times \left(\frac{128}{256}\right) = +\frac{REF}{2}$
0	1	1	1	1	1	1	1	$+REF \times \left(\frac{127}{256}\right)$
0	0	0	0	0	0	0	1	$+REF \times \left(\frac{1}{256}\right)$
0	0	0	0	0	0	0	0	0V

**Note:**

$$1\text{LSB} = REF \times 2^{-8} = REF \times \left(\frac{1}{256}\right)$$

$$\text{ANALOG OUTPUT} = REF \times \left(\frac{D}{256}\right) \text{ where } D = \text{decimal value of digital input}$$

# Dual, 8-Bit, Voltage-Output Serial DAC in 8-Pin SOT23

MAX5222

## **Applications Information**

The MAX5222 is specified for single-supply operation with  $V_{DD}$  ranging from 2.7V to 5.5V, covering all commonly used supply voltages in 3V and 5V systems.

### **Initialization**

An internal power-on reset circuit forces the outputs to zero scale and initializes all external registers to zero. This is equivalent to being in the shutdown state. Therefore, at power-up, perform an initial write operation to set the outputs to the desired voltage.

### **Power-Supply and Ground Management**

GND should be connected to the highest quality ground available. Bypass  $V_{DD}$  with a 0.1 $\mu$ F to 0.22 $\mu$ F capacitor to GND. The reference input can be used without bypassing. For optimum line/load-transient response and noise performance, bypass the reference input with 0.1 $\mu$ F to 4.7 $\mu$ F to GND. Careful PC board layout minimizes crosstalk among DAC outputs, the reference, and digital inputs. Separate analog lines with ground traces between them. Make sure that high-frequency digital lines are not routed in parallel to analog lines.

## **Chip Information**

TRANSISTOR COUNT: 1480

PROCESS TECHNOLOGY: BiCMOS

# Dual, 8-Bit, Voltage-Output Serial DAC in 8-Pin SOT23

## Package Information

PIN 1 I.D. DOT (SEE NOTE 7)

SYMBOL	MIN	MAX
A	0.90	1.45
A1	0.00	0.15
A2	0.90	1.30
b	0.28	0.45
C	0.09	0.20
D	2.80	3.00
E	2.60	3.00
E1	1.50	1.75
L	0.10	0.60
e	0.65 ref	
e1	1.95 ref	
$\alpha$	0°	10°

NOTE:

- ALL DIMENSIONS ARE IN MILLIMETERS.
- FOOT LENGTH MEASURED REFERENCE TO FLAT FOOT SURFACE PARALLEL TO DATUM "A".
- PACKAGE OUTLINE EXCLUSIVE OF MOLD FLASH & METAL BURR.
- PACKAGE OUTLINE INCLUSIVE OF SOLDER PLATING.
- EIAJ REF. NUMBER SC-74 (6 LEAD VERSION)
- COPLANARITY 4 MILS. MAX.
- PIN 1 I.D. DOT IS 0.3 MM  $\phi$  MIN. LOCATED ABOVE PIN 1.

MAXIM  
PROPRIETARY INFORMATION

TITLE:  
PACKAGE OUTLINE, SOT 23, 8L

APPROVAL	DOCUMENT CONTROL NO. 21-0078	REV B	1/1
----------	---------------------------------	----------	-----

SOT23, 8LEPS

Maxim cannot assume responsibility for use of any circuitry other than circuitry entirely embodied in a Maxim product. No circuit patent licenses are implied. Maxim reserves the right to change the circuitry and specifications without notice at any time.

12 Maxim Integrated Products, 120 San Gabriel Drive, Sunnyvale, CA 94086 408-737-7600



**Стандарт  
Электрон  
Связь**

Мы молодая и активно развивающаяся компания в области поставок электронных компонентов. Мы поставляем электронные компоненты отечественного и импортного производства напрямую от производителей и с крупнейших складов мира.

Благодаря сотрудничеству с мировыми поставщиками мы осуществляем комплексные и плановые поставки широчайшего спектра электронных компонентов.

Собственная эффективная логистика и склад в обеспечивает надежную поставку продукции в точно указанные сроки по всей России.

Мы осуществляем техническую поддержку нашим клиентам и предпродажную проверку качества продукции. На все поставляемые продукты мы предоставляем гарантию .

Осуществляем поставки продукции под контролем ВП МО РФ на предприятия военно-промышленного комплекса России , а также работаем в рамках 275 ФЗ с открытием отдельных счетов в уполномоченном банке. Система менеджмента качества компании соответствует требованиям ГОСТ ISO 9001.

Минимальные сроки поставки, гибкие цены, неограниченный ассортимент и индивидуальный подход к клиентам являются основой для выстраивания долгосрочного и эффективного сотрудничества с предприятиями радиоэлектронной промышленности, предприятиями ВПК и научно-исследовательскими институтами России.

С нами вы становитесь еще успешнее!

**Наши контакты:**

**Телефон:** +7 812 627 14 35

**Электронная почта:** [sales@st-electron.ru](mailto:sales@st-electron.ru)

**Адрес:** 198099, Санкт-Петербург,  
Промышленная ул, дом № 19, литера Н,  
помещение 100-Н Офис 331