



# MICROCHIP TC4423A/TC4424A/TC4425A

## 3A Dual High-Speed Power MOSFET Drivers

### Features

- High Peak Output Current: 4.5A (typical)
- Wide Input Supply Voltage Operating Range:
  - 4.5V to 18V
- High Capacitive Load Drive Capability:
  - 1800 pF in 12 ns
- Short Delay Times: 40 ns (typical)
- Matched Rise/Fall Times
- Low Supply Current:
  - With Logic '1' Input – 1.0 mA (maximum)
  - With Logic '0' Input – 150  $\mu$ A (maximum)
- Low Output Impedance: 2.5 $\Omega$  (typical)
- Latch-Up Protected: Will Withstand 1.5A Reverse Current
- Logic Input Will Withstand Negative Swing Up To 5V
- Pin compatible with the TC4423/TC4424/TC4425 and TC4426A/TC4427A/TC4428A devices
- Space-saving 8-Pin 150 mil body SOIC and 8-Pin 6x5 DFN Packages

### Applications

- Switch Mode Power Supplies
- Pulse Transformer Drive
- Line Drivers
- Direct Drive of Small DC Motors

### General Description

The TC4423A/TC4424A/TC4425A devices are a family of dual-output 3A buffers/MOSFET drivers. These devices are improved versions of the earlier TC4423/TC4424/TC4425 dual-output 3A driver family. This improved version features higher peak output current drive capability, lower shoot-through current, matched rise/fall times and propagation delay times. The TC4423A/TC4424A/TC4425A devices are pin-compatible with the existing TC4423/TC4424/TC4425 family. An 8-pin SOIC package option has been added to the family. The 8-pin DFN package option offers increased power dissipation capability for driving heavier capacitive or resistive loads.

The TC4423A/TC4424A/TC4425A MOSFET drivers can easily charge and discharge 1800 pF gate capacitance in under 20 ns, provide low enough impedances in both the on and off states to ensure the MOSFET's intended state will not be affected, even by large transients.

The TC4423A/TC4424A/TC4425A inputs may be driven directly from either TTL or CMOS (2.4V to 18V). In addition, the 300 mV of built-in hysteresis provides noise immunity and allows the device to be driven from slow rising or falling waveforms.

The TC4423A/TC4424A/TC4425A dual-output 3A MOSFET driver family is offered with a -40°C to +125°C temperature rating, making it useful in any wide temperature range application.

### Package Types

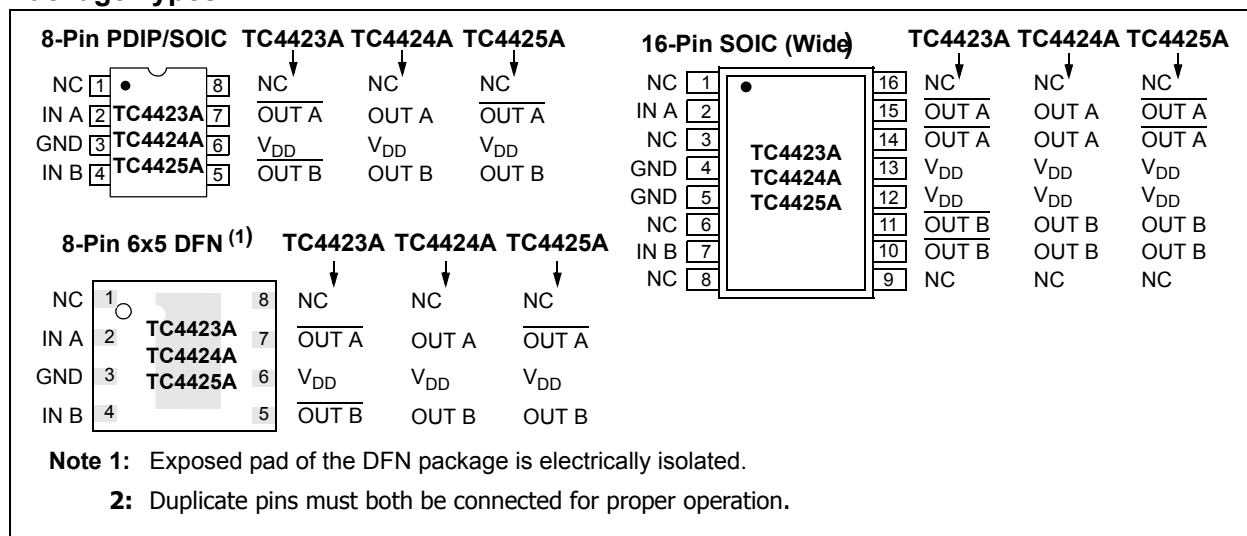

# TC4423A/TC4424A/TC4425A

## Functional Block Diagram<sup>(1)</sup>



# TC4423A/TC4424A/TC4425A

## 1.0 ELECTRICAL CHARACTERISTICS

### Absolute Maximum Ratings †

|  |                                   |
|--|-----------------------------------|
| Supply Voltage .....                           | +20V                              |
| Input Voltage, IN A or IN B .....              | ( $V_{DD} + 0.3V$ ) to (GND – 5V) |
| Package Power Dissipation ( $T_A=50^\circ C$ ) |                                   |
| 8L PDIP .....                                  | 1.2W                              |
| 8L SOIC.....                                   | 0.61W                             |
| 16L SOIC.....                                  | 1.1W                              |
| 8L DFN .....                                   | <b>Note 3</b>                     |

† **Notice:** Stresses above those listed under "Maximum Ratings" may cause permanent damage to the device. This is a stress rating only and functional operation of the device at those or any other conditions above those indicated in the operational sections of this specification is not intended. Exposure to maximum rating conditions for extended periods may affect device reliability.

### DC CHARACTERISTICS (NOTE 2)

| Electrical Specifications: Unless otherwise indicated, $T_A = +25^\circ C$ , with $4.5V \leq V_{DD} \leq 18V$ . |           |                  |      |              |          |   |
|---|-----------|------------------|------|--------------|----------|---|
| Parameters  | Sym       | Min              | Typ  | Max          | Units    | Conditions  |
| <b>Input</b>  |           |                  |      |              |          |   |
| Logic '1', High Input Voltage   | $V_{IH}$  | 2.4              | 1.5  | —            | V        |   |
| Logic '0', Low Input Voltage  | $V_{IL}$  | —                | 1.3  | 0.8          | V        |   |
| Input Current   | $I_{IN}$  | -1               | —    | 1            | $\mu A$  | $0V \leq V_{IN} \leq V_{DD}$                          |
| Input Voltage   | $V_{IN}$  | -5               | —    | $V_{DD}+0.3$ | V        |   |
| <b>Output</b>   |           |                  |      |              |          |   |
| High Output Voltage   | $V_{OH}$  | $V_{DD} - 0.025$ | —    | —            | V        | DC Test   |
| Low Output Voltage  | $V_{OL}$  | —                | —    | 0.025        | V        | DC Test   |
| Output Resistance, High   | $R_{OH}$  | —                | 2.2  | 3.0          | $\Omega$ | $I_{OUT} = 10\text{ mA}$ , $V_{DD} = 18V$             |
| Output Resistance, Low  | $R_{OL}$  | —                | 2.8  | 3.5          | $\Omega$ | $I_{OUT} = 10\text{ mA}$ , $V_{DD} = 18V$             |
| Peak Output Current   | $I_{PK}$  | —                | 4.5  | —            | A        | $10V \leq V_{DD} \leq 18V$ ( <b>Note 2</b> )          |
| Latch-Up Protection Withstand Reverse Current   | $I_{REV}$ | —                | >1.5 | —            | A        | Duty cycle $\leq 2\%$ , $t \leq 300\ \mu\text{sec}$ . |
| <b>Switching Time (Note 1)</b>  |           |                  |      |              |          |   |
| Rise Time   | $t_R$     | —                | 12   | 21           | ns       | Figure 4-1, Figure 4-2, $C_L = 1800\text{ pF}$        |
| Fall Time   | $t_F$     | —                | 12   | 21           | ns       | Figure 4-1, Figure 4-2, $C_L = 1800\text{ pF}$        |
| Delay Time  | $t_{D1}$  | —                | 40   | 48           | ns       | Figure 4-1, Figure 4-2, $C_L = 1800\text{ pF}$        |
| Delay Time  | $t_{D2}$  | —                | 41   | 48           | ns       | Figure 4-1, Figure 4-2, $C_L = 1800\text{ pF}$        |
| <b>Power Supply</b>   |           |                  |      |              |          |   |
| Supply Voltage  | $V_{DD}$  | 4.5              | —    | 18           | V        |   |
| Power Supply Current  | $I_S$     | —                | 1.0  | 2.0          | mA       | $V_{IN} = 3V$ (Both inputs)                           |
|   | $I_S$     | —                | 0.15 | 0.25         | mA       | $V_{IN} = 0V$ (Both inputs)                           |

**Note 1:** Switching times ensured by design.

**2:** Tested during characterization, not production tested.

**3:** Package power dissipation is dependent on the copper pad area on the PCB.

# TC4423A/TC4424A/TC4425A

## DC CHARACTERISTICS (OVER OPERATING TEMPERATURE RANGE)

| Electrical Specifications: Unless otherwise indicated, operating temperature range with $4.5V \leq V_{DD} \leq 18V$ . |          |                  |            |            |          |  |
|---|----------|------------------|------------|------------|----------|--|
| Parameters  | Sym      | Min              | Typ        | Max        | Units    | Conditions   |
| <b>Input</b>  |          |                  |            |            |          |  |
| Logic '1', High Input Voltage   | $V_{IH}$ | 2.4              | —          | —          | V        |  |
| Logic '0', Low Input Voltage  | $V_{IL}$ | —                | —          | 0.8        | V        |  |
| Input Current   | $I_{IN}$ | -10              | —          | +10        | $\mu A$  | $0V \leq V_{IN} \leq V_{DD}$                               |
| <b>Output</b>   |          |                  |            |            |          |  |
| High Output Voltage   | $V_{OH}$ | $V_{DD} - 0.025$ | —          | —          | V        |  |
| Low Output Voltage  | $V_{OL}$ | —                | —          | 0.025      | V        |  |
| Output Resistance, High   | $R_{OH}$ | —                | 3.1        | 6          | $\Omega$ | $I_{OUT} = 10 \text{ mA}, V_{DD} = 18V$                    |
| Output Resistance, Low  | $R_{OL}$ | —                | 3.7        | 7          | $\Omega$ | $I_{OUT} = 10 \text{ mA}, V_{DD} = 18V$                    |
| <b>Switching Time (Note 1)</b>  |          |                  |            |            |          |  |
| Rise Time   | $t_R$    | —                | 20         | 31         | ns       | Figure 4-1, Figure 4-2,<br>$C_L = 1800 \text{ pF}$         |
| Fall Time   | $t_F$    | —                | 22         | 31         | ns       | Figure 4-1, Figure 4-2,<br>$C_L = 1800 \text{ pF}$         |
| Delay Time  | $t_{D1}$ | —                | 50         | 66         | ns       | Figure 4-1, Figure 4-2,<br>$C_L = 1800 \text{ pF}$         |
| Delay Time  | $t_{D2}$ | —                | 50         | 66         | ns       | Figure 4-1, Figure 4-2,<br>$C_L = 1800 \text{ pF}$         |
| <b>Power Supply</b>   |          |                  |            |            |          |  |
| Power Supply Current  | $I_S$    | —<br>—           | 2.0<br>0.2 | 3.0<br>0.3 | mA       | $V_{IN} = 3V$ (Both inputs)<br>$V_{IN} = 0V$ (Both inputs) |

**Note 1:** Switching times ensured by design.

## TEMPERATURE CHARACTERISTICS

| Electrical Specifications: Unless otherwise noted, all parameters apply with $4.5V \leq V_{DD} \leq 18V$ . |               |     |      |      |               |  |
|--|---------------|-----|------|------|---------------|--|
| Parameters   | Sym           | Min | Typ  | Max  | Units         | Conditions   |
| <b>Temperature Ranges</b>  |               |     |      |      |               |  |
| Specified Temperature Range (V)  | $T_A$         | -40 | —    | +125 | $^{\circ}C$   |  |
| Maximum Junction Temperature   | $T_J$         | —   | —    | +150 | $^{\circ}C$   |  |
| Storage Temperature Range  | $T_A$         | -65 | —    | +150 | $^{\circ}C$   |  |
| <b>Package Thermal Resistances</b>   |               |     |      |      |               |  |
| Thermal Resistance, 8L-6x5 DFN   | $\theta_{JA}$ | —   | 33.2 | —    | $^{\circ}C/W$ | Typical four-layer board with vias to ground plane |
| Thermal Resistance, 8L-PDIP  | $\theta_{JA}$ | —   | 84.6 | —    | $^{\circ}C/W$ |  |
| Thermal Resistance, 8L-SOIC  | $\theta_{JA}$ | —   | 163  | —    | $^{\circ}C/W$ |  |
| Thermal Resistance, 16L-SOIC   | $\theta_{JA}$ | —   | 90   | —    | $^{\circ}C/W$ |  |

# TC4423A/TC4424A/TC4425A

## 2.0 TYPICAL PERFORMANCE CURVES

**Note:** The graphs and tables provided following this note are a statistical summary based on a limited number of samples and are provided for informational purposes only. The performance characteristics listed herein are not tested or guaranteed. In some graphs or tables, the data presented may be outside the specified operating range (e.g., outside specified power supply range) and therefore outside the warranted range.

**Note:** Unless otherwise indicated,  $T_A = +25^\circ\text{C}$  with  $4.5\text{V} \leq V_{DD} \leq 18\text{V}$ .



**FIGURE 2-1:** Rise Time vs. Supply Voltage.

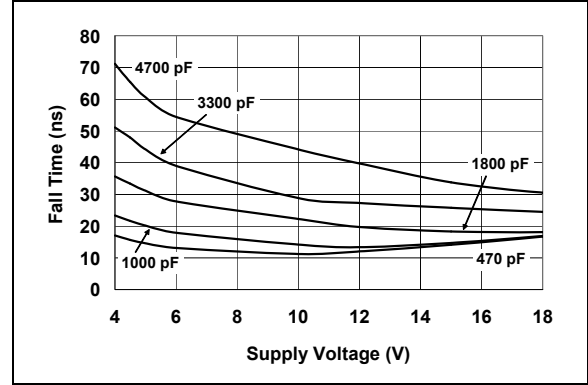

**FIGURE 2-4:** Fall Time vs. Supply Voltage.



**FIGURE 2-2:** Rise Time vs. Capacitive Load.

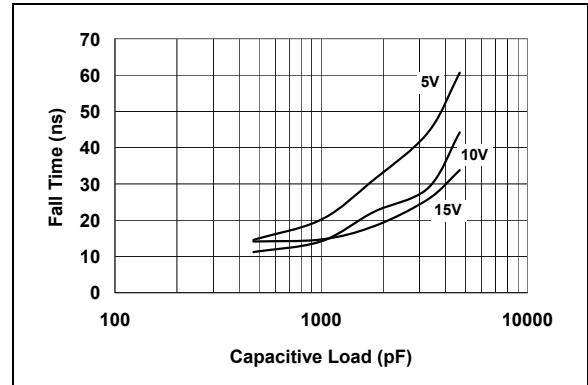

**FIGURE 2-5:** Fall Time vs. Capacitive Load.



**FIGURE 2-3:** Rise and Fall Times vs. Temperature.

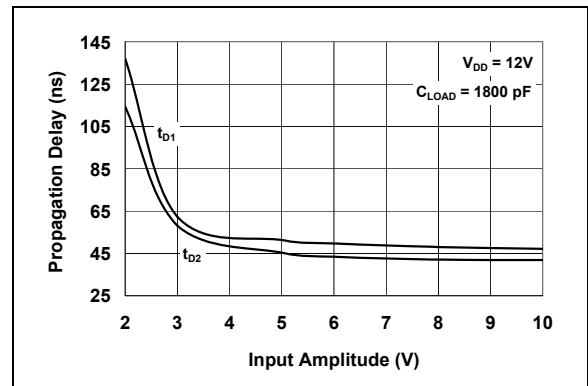

**FIGURE 2-6:** Propagation Delay vs. Input Amplitude.

# TC4423A/TC4424A/TC4425A

## Typical Performance Curves (Continued)

Note: Unless otherwise indicated,  $T_A = +25^\circ\text{C}$  with  $4.5\text{V} \leq V_{DD} \leq 18\text{V}$ .



**FIGURE 2-7:** Propagation Delay Time vs. Supply Voltage.



**FIGURE 2-10:** Propagation Delay Time vs. Temperature.



**FIGURE 2-8:** Quiescent Current vs. Supply Voltage.



**FIGURE 2-11:** Quiescent Current vs. Temperature.

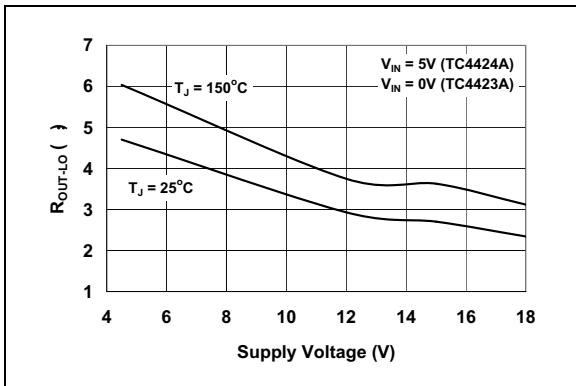

**FIGURE 2-9:** Output Resistance (Output Low) vs. Supply Voltage.

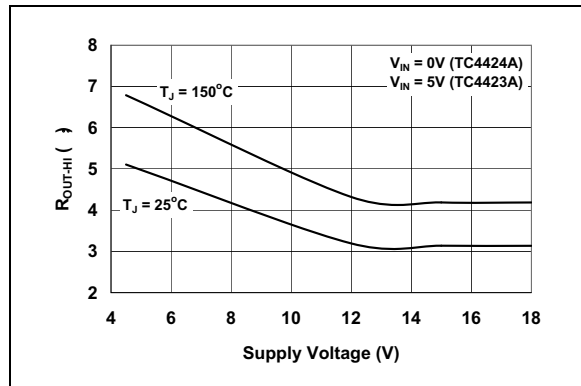

**FIGURE 2-12:** Output Resistance (Output High) vs. Supply Voltage.

# TC4423A/TC4424A/TC4425A

## Typical Performance Curves (Continued)

Note: Unless otherwise indicated,  $T_A = +25^\circ\text{C}$  with  $4.5\text{V} \leq V_{DD} \leq 18\text{V}$ .



**FIGURE 2-13:** Supply Current vs. Capacitive Load.



**FIGURE 2-16:** Supply Current vs. Frequency.



**FIGURE 2-14:** Supply Current vs. Capacitive Load.



**FIGURE 2-17:** Supply Current vs. Frequency.



**FIGURE 2-15:** Supply Current vs. Capacitive Load.



**FIGURE 2-18:** Supply Current vs. Frequency.

# TC4423A/TC4424A/TC4425A

## Typical Performance Curves (Continued)

Note: Unless otherwise indicated,  $T_A = +25^\circ\text{C}$  with  $4.5\text{V} \leq V_{DD} \leq 18\text{V}$ .



**FIGURE 2-19:** Crossover Energy vs. Supply Voltage.



## 3.0 PIN DESCRIPTIONS

The descriptions of the pins are listed in Table 3-1.

**TABLE 3-1: PIN FUNCTION TABLE <sup>(1)</sup>**

| 8-Pin PDIP | 8-Pin DFN | 16-Pin SOIC (Wide) | Symbol          | Description       |
|------------|-----------|--------------------|-----------------|-------------------|
| 1          | 1         | 1                  | NC              | No connection     |
| 2          | 2         | 2                  | IN A            | Input A           |
| —          | —         | 3                  | NC              | No connection     |
| 3          | 3         | 4                  | GND             | Ground            |
| —          | —         | 5                  | GND             | Ground            |
| —          | —         | 6                  | NC              | No connection     |
| 4          | 4         | 7                  | IN B            | Input B           |
| —          | —         | 8                  | NC              | No connection     |
| —          | —         | 9                  | NC              | No connection     |
| 5          | 5         | 10                 | OUT B           | Output B          |
| —          | —         | 11                 | OUT B           | Output B          |
| 6          | 6         | 12                 | V <sub>DD</sub> | Supply input      |
| —          | —         | 13                 | V <sub>DD</sub> | Supply input      |
| 7          | 7         | 14                 | OUT A           | Output A          |
| —          | —         | 15                 | OUT A           | Output A          |
| 8          | 8         | 16                 | NC              | No connection     |
| —          | PAD       | —                  | NC              | Exposed Metal Pad |

**Note 1:** Duplicate pins must be connected for proper operation.

### 3.1 Inputs A and B

Inputs A and B are TTL/CMOS compatible inputs that control outputs A and B, respectively. These inputs have 300 mV of hysteresis between the high and low input levels, allowing them to be driven from slow rising and falling signals, and to provide noise immunity.

### 3.2 Outputs A and B

Outputs A and B are CMOS push-pull outputs that are capable of sourcing and sinking 3A peaks of current (V<sub>DD</sub> = 18V). The low output impedance ensures the gate of the external MOSFET will stay in the intended state even during large transients. These outputs also have a reverse current latch-up rating of 1.5A.

### 3.3 Supply Input (V<sub>DD</sub>)

V<sub>DD</sub> is the bias supply input for the MOSFET driver and has a voltage range of 4.5V to 18V. This input must be decoupled to ground with a local ceramic capacitor. This bypass capacitor provides a localized low-impedance path for the peak currents that are to be provided to the load.

### 3.4 Ground (GND)

Ground is the device return pin. The ground pin should have a low-impedance connection to the bias supply source return. High peak currents will flow out the ground pin when the capacitive load is being discharged.

### 3.5 Exposed Metal Pad

The exposed metal pad of the DFN package is not internally connected to any potential. Therefore, this pad can be connected to a ground plane or other copper plane on a printed circuit board to aid in heat removal from the package.

# TC4423A/TC4424A/TC4425A

## 4.0 APPLICATIONS INFORMATION



**FIGURE 4-1:** Inverting Driver Switching Time.



**FIGURE 4-2:** Non-inverting Driver Switching Time.

# TC4423A/TC4424A/TC4425A

## 5.0 PACKAGING INFORMATION

### 5.1 Package Marking Information (Not to Scale)

8-Lead DFN (6x5)



Example:



8-Lead PDIP (300 mil)



Example:

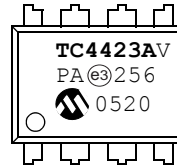

8-Lead SOIC (150 mil)



Example:

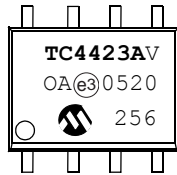

16-Lead SOIC (300 mil)

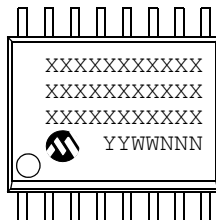

Example:

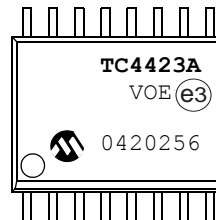

|                |        |  |
|----------------|--------|--|
| <b>Legend:</b> | XX...X | Customer-specific information  |
|                | Y      | Year code (last digit of calendar year)  |
|                | YY     | Year code (last 2 digits of calendar year)   |
|                | WW     | Week code (week of January 1 is week '01')   |
|                | NNN    | Alphanumeric traceability code   |
|                | (e3)   | Pb-free JEDEC designator for Matte Tin (Sn)  |
|                | *      | This package is Pb-free. The Pb-free JEDEC designator (e3) can be found on the outer packaging for this package. |

**Note:** In the event the full Microchip part number cannot be marked on one line, it will be carried over to the next line, thus limiting the number of available characters for customer-specific information.

# TC4423A/TC4424A/TC4425A

## 8-Lead Plastic Dual Flat, No Lead Package (MF) – 6x5 mm Body [DFN-S] PUNCH SINGULATED

**Note:** For the most current package drawings, please see the Microchip Packaging Specification located at <http://www.microchip.com/packaging>



|                          |        | Units | MILLIMETERS |     |      |
|--------------------------|--------|-------|-------------|-----|------|
| Dimension Limits         |        |       | MIN         | NOM | MAX  |
| Number of Pins           | N      |       | 8           |     |      |
| Pitch                    | e      |       | 1.27 BSC    |     |      |
| Overall Height           | A      | –     | 0.85        |     | 1.00 |
| Molded Package Thickness | A2     | –     | 0.65        |     | 0.80 |
| Standoff                 | A1     | 0.00  | 0.01        |     | 0.05 |
| Base Thickness           | A3     |       | 0.20 REF    |     |      |
| Overall Length           | D      |       | 4.92 BSC    |     |      |
| Molded Package Length    | D1     |       | 4.67 BSC    |     |      |
| Exposed Pad Length       | D2     | 3.85  | 4.00        |     | 4.15 |
| Overall Width            | E      |       | 5.99 BSC    |     |      |
| Molded Package Width     | E1     |       | 5.74 BSC    |     |      |
| Exposed Pad Width        | E2     | 2.16  | 2.31        |     | 2.46 |
| Contact Width            | b      | 0.35  | 0.40        |     | 0.47 |
| Contact Length           | L      | 0.50  | 0.60        |     | 0.75 |
| Contact-to-Exposed Pad   | K      | 0.20  | –           |     | –    |
| Model Draft Angle Top    | $\phi$ | –     | –           |     | 12°  |

**Notes:**

- Pin 1 visual index feature may vary, but must be located within the hatched area.
- Package may have one or more exposed tie bars at ends.
- Dimensioning and tolerancing per ASME Y14.5M.

BSC: Basic Dimension. Theoretically exact value shown without tolerances.

REF: Reference Dimension, usually without tolerance, for information purposes only.

Microchip Technology Drawing C04-113B

# TC4423A/TC4424A/TC4425A

## 8-Lead Plastic Dual In-Line (PA) – 300 mil Body [PDIP]

**Note:** For the most current package drawings, please see the Microchip Packaging Specification located at <http://www.microchip.com/packaging>



| Dimension Limits           | Units | INCHES   |      |      |
|----------------------------|-------|----------|------|------|
|                            |       | MIN      | NOM  | MAX  |
| Number of Pins             | N     | 8        |      |      |
| Pitch                      | e     | .100 BSC |      |      |
| Top to Seating Plane       | A     | –        | –    | .210 |
| Molded Package Thickness   | A2    | .115     | .130 | .195 |
| Base to Seating Plane      | A1    | .015     | –    | –    |
| Shoulder to Shoulder Width | E     | .290     | .310 | .325 |
| Molded Package Width       | E1    | .240     | .250 | .280 |
| Overall Length             | D     | .348     | .365 | .400 |
| Tip to Seating Plane       | L     | .115     | .130 | .150 |
| Lead Thickness             | c     | .008     | .010 | .015 |
| Upper Lead Width           | b1    | .040     | .060 | .070 |
| Lower Lead Width           | b     | .014     | .018 | .022 |
| Overall Row Spacing §      | eB    | –        | –    | .430 |

**Notes:**

- Pin 1 visual index feature may vary, but must be located with the hatched area.
- § Significant Characteristic.
- Dimensions D and E1 do not include mold flash or protrusions. Mold flash or protrusions shall not exceed .010" per side.
- Dimensioning and tolerancing per ASME Y14.5M.

BSC: Basic Dimension. Theoretically exact value shown without tolerances.

Microchip Technology Drawing C04-018B

# TC4423A/TC4424A/TC4425A

## 8-Lead Plastic Small Outline (OA) – Narrow, 3.90 mm Body [SOIC]

**Note:** For the most current package drawings, please see the Microchip Packaging Specification located at <http://www.microchip.com/packaging>



|                          |    | Units | MILLIMETERS |     |      |
|--------------------------|----|-------|-------------|-----|------|
| Dimension Limits         |    |       | MIN         | NOM | MAX  |
| Number of Pins           | N  |       | 8           |     |      |
| Pitch                    | e  |       | 1.27 BSC    |     |      |
| Overall Height           | A  | –     | –           | –   | 1.75 |
| Molded Package Thickness | A2 |       | 1.25        | –   | –    |
| Standoff §               | A1 |       | 0.10        | –   | 0.25 |
| Overall Width            | E  |       | 6.00 BSC    |     |      |
| Molded Package Width     | E1 |       | 3.90 BSC    |     |      |
| Overall Length           | D  |       | 4.90 BSC    |     |      |
| Chamfer (optional)       | h  |       | 0.25        | –   | 0.50 |
| Foot Length              | L  |       | 0.40        | –   | 1.27 |
| Footprint                | L1 |       | 1.04 REF    |     |      |
| Foot Angle               | φ  |       | 0°          | –   | 8°   |
| Lead Thickness           | c  |       | 0.17        | –   | 0.25 |
| Lead Width               | b  |       | 0.31        | –   | 0.51 |
| Mold Draft Angle Top     | α  |       | 5°          | –   | 15°  |
| Mold Draft Angle Bottom  | β  |       | 5°          | –   | 15°  |

**Notes:**

- Pin 1 visual index feature may vary, but must be located within the hatched area.
- § Significant Characteristic.
- Dimensions D and E1 do not include mold flash or protrusions. Mold flash or protrusions shall not exceed 0.15 mm per side.
- Dimensioning and tolerancing per ASME Y14.5M.

BSC: Basic Dimension. Theoretically exact value shown without tolerances.

REF: Reference Dimension, usually without tolerance, for information purposes only.

Microchip Technology Drawing C04-057B

# TC4423A/TC4424A/TC4425A

## 16-Lead Plastic Small Outline (OE) – Wide, 7.50 mm Body [SOIC]

**Note:** For the most current package drawings, please see the Microchip Packaging Specification located at <http://www.microchip.com/packaging>



| Dimension Limits         | Units    | MILLIMETERS |     |      |
|--------------------------|----------|-------------|-----|------|
|                          |          | MIN         | NOM | MAX  |
| Number of Pins           | N        | 16          |     |      |
| Pitch                    | e        | 1.27 BSC    |     |      |
| Overall Height           | A        | –           | –   | 2.65 |
| Molded Package Thickness | A2       | 2.05        | –   | –    |
| Standoff §               | A1       | 0.10        | –   | 0.30 |
| Overall Width            | E        | 10.30 BSC   |     |      |
| Molded Package Width     | E1       | 7.50 BSC    |     |      |
| Overall Length           | D        | 10.30 BSC   |     |      |
| Chamfer (optional)       | h        | 0.25        | –   | 0.75 |
| Foot Length              | L        | 0.40        | –   | 1.27 |
| Footprint                | L1       | 1.40 REF    |     |      |
| Foot Angle               | $\phi$   | 0°          | –   | 8°   |
| Lead Thickness           | c        | 0.20        | –   | 0.33 |
| Lead Width               | b        | 0.31        | –   | 0.51 |
| Mold Draft Angle Top     | $\alpha$ | 5°          | –   | 15°  |
| Mold Draft Angle Bottom  | $\beta$  | 5°          | –   | 15°  |

**Notes:**

- Pin 1 visual index feature may vary, but must be located within the hatched area.
- § Significant Characteristic.
- Dimensions D and E1 do not include mold flash or protrusions. Mold flash or protrusions shall not exceed 0.15 mm per side.
- Dimensioning and tolerancing per ASME Y14.5M.

BSC: Basic Dimension. Theoretically exact value shown without tolerances.

REF: Reference Dimension, usually without tolerance, for information purposes only.

Microchip Technology Drawing C04-102B

# TC4423A/TC4424A/TC4425A

---

NOTES:



## APPENDIX A: REVISION HISTORY

### Revision B (April 2007)

- Correct numerous errors throughout document.
- Page 3: Added Package Power Dissipation information about DC Characteristic Table.
- Page 3: Added Note 3 to DC Characteristic Table.
- Page 4: Changed Thermal Resistance for 8L-PDIP device from 125 to 84.6.  
Changed Thermal Resistance for 8L-SOIC from 155 to 163.
- Page 12: Updated Package Outline Drawing.
- Page 13: Updated Package Outline Drawing.
- Page 14: Updated Package Outline Drawing.
- Page 15: Added 16-Lead SOIC Package Outline Drawing
- Page 17: Updated Revision History.

### Revision A (June 2006)

- Original Release of this Document.

# TC4423A/TC4424A/TC4425A

---

NOTES:

# TC4423A/TC4424A/TC4425A

## PRODUCT IDENTIFICATION SYSTEM

To order or obtain information, e.g., on pricing or delivery, refer to the factory or the listed sales office.

| <u>PART NO.</u>    | <u>X</u>          | <u>XX</u>  | <u>XXX</u>  | <b>Examples:</b>   |
|--------------------|-------------------|--|-------------|--|
| Device             | Temperature Range | Package  | Tape & Reel |  |
| Device:            |                   | TC4423A: 3A Dual MOSFET Driver, Inverting<br>TC4424A: 3A Dual MOSFET Driver, Non-Inverting<br>TC4425A: 3A Dual MOSFET Driver, Complementary  |             | a) TC4423AVOA: 3A Dual Inverting MOSFET Driver, 8LD SOIC package.<br>b) TC4423AVPA: 3A Dual Inverting MOSFET Driver, 8LD PDIP package.<br>c) TC4423AVMF: 3A Dual Inverting MOSFET Driver, 8LD DFN package.<br>d) TC4423AVOE: 3A Dual Inverting MOSFET Driver, 16LD SOIC package. |
| Temperature Range: | V =               | -40°C to +125°C  |             | a) TC4424AVOA713: 3A Dual Non-Inverting, MOSFET Driver, 8LD SOIC package, Tape and Reel.<br>b) TC4424AVPA: 3A Dual Non-Inverting, MOSFET Driver, 8LD PDIP package.   |
| Package: *         |                   | MF = Dual, Flat, No-Lead (6x5 mm Body), 8-lead<br>MF713 = Dual, Flat, No-Lead (6x5 mm Body), 8-lead (Tape and Reel)<br>OA = Plastic SOIC (150 mil Body), 8-Lead<br>OA713 = Plastic SOIC (150 mil Body), 8-Lead (Tape and Reel)<br>OE = Plastic SOIC (Wide Body), 16-lead<br>OE713 = Plastic SOIC (Wide Body), 16-lead (Tape and Reel)<br>PA = Plastic DIP, (300 mil body), 8-lead<br>* All package offerings are Pb Free (Lead Free) |             | a) TC4425AVOA: 3A Dual Complementary, MOSFET Driver, 8LD SOIC package.<br>b) TC4425AVPA: 3A Dual Complementary, MOSFET Driver, 8LD PDIP package.<br>c) TC4425AVOE713: 3A Dual Complementary, MOSFET Driver, 16LD SOIC package, Tape and Reel.                                    |

# TC4423A/TC4424A/TC4425A

---

NOTES:

---

**Note the following details of the code protection feature on Microchip devices:**

- Microchip products meet the specification contained in their particular Microchip Data Sheet.
- Microchip believes that its family of products is one of the most secure families of its kind on the market today, when used in the intended manner and under normal conditions.
- There are dishonest and possibly illegal methods used to breach the code protection feature. All of these methods, to our knowledge, require using the Microchip products in a manner outside the operating specifications contained in Microchip's Data Sheets. Most likely, the person doing so is engaged in theft of intellectual property.
- Microchip is willing to work with the customer who is concerned about the integrity of their code.
- Neither Microchip nor any other semiconductor manufacturer can guarantee the security of their code. Code protection does not mean that we are guaranteeing the product as "unbreakable."

Code protection is constantly evolving. We at Microchip are committed to continuously improving the code protection features of our products. Attempts to break Microchip's code protection feature may be a violation of the Digital Millennium Copyright Act. If such acts allow unauthorized access to your software or other copyrighted work, you may have a right to sue for relief under that Act.

---

Information contained in this publication regarding device applications and the like is provided only for your convenience and may be superseded by updates. It is your responsibility to ensure that your application meets with your specifications. MICROCHIP MAKES NO REPRESENTATIONS OR WARRANTIES OF ANY KIND WHETHER EXPRESS OR IMPLIED, WRITTEN OR ORAL, STATUTORY OR OTHERWISE, RELATED TO THE INFORMATION, INCLUDING BUT NOT LIMITED TO ITS CONDITION, QUALITY, PERFORMANCE, MERCHANTABILITY OR FITNESS FOR PURPOSE. Microchip disclaims all liability arising from this information and its use. Use of Microchip devices in life support and/or safety applications is entirely at the buyer's risk, and the buyer agrees to defend, indemnify and hold harmless Microchip from any and all damages, claims, suits, or expenses resulting from such use. No licenses are conveyed, implicitly or otherwise, under any Microchip intellectual property rights.

**Trademarks**

The Microchip name and logo, the Microchip logo, Accuron, dsPIC, KEELOQ, KEELOQ logo, microID, MPLAB, PIC, PICmicro, PICSTART, PRO MATE, PowerSmart, rPIC, and SmartShunt are registered trademarks of Microchip Technology Incorporated in the U.S.A. and other countries.

AmpLab, FilterLab, Linear Active Thermistor, Migratable Memory, MXDEV, MXLAB, PS logo, SEEVAL, SmartSensor and The Embedded Control Solutions Company are registered trademarks of Microchip Technology Incorporated in the U.S.A.

Analog-for-the-Digital Age, Application Maestro, CodeGuard, dsPICDEM, dsPICDEM.net, dsPICworks, ECAN, ECONOMONITOR, FanSense, FlexROM, fuzzyLAB, In-Circuit Serial Programming, ICSP, ICEPIC, Mindi, MiWi, MPASM, MPLAB Certified logo, MPLIB, MPLINK, PICkit, PICDEM, PICDEM.net, PICLAB, PICtail, PowerCal, PowerInfo, PowerMate, PowerTool, REAL ICE, rLAB, rfPICDEM, Select Mode, Smart Serial, SmartTel, Total Endurance, UNI/O, WiperLock and ZENA are trademarks of Microchip Technology Incorporated in the U.S.A. and other countries.

SQTP is a service mark of Microchip Technology Incorporated in the U.S.A.

All other trademarks mentioned herein are property of their respective companies.

© 2007, Microchip Technology Incorporated, Printed in the U.S.A., All Rights Reserved.

 Printed on recycled paper.

*Microchip received ISO/TS-16949:2002 certification for its worldwide headquarters, design and wafer fabrication facilities in Chandler and Tempe, Arizona, Gresham, Oregon and Mountain View, California. The Company's quality system processes and procedures are for its PIC<sup>®</sup> MCUs and dsPIC<sup>®</sup> DSCs, KEELOQ<sup>®</sup> code hopping devices, Serial EEPROMs, microperipherals, nonvolatile memory and analog products. In addition, Microchip's quality system for the design and manufacture of development systems is ISO 9001:2000 certified.*

**QUALITY MANAGEMENT SYSTEM  
CERTIFIED BY DNV  
== ISO/TS 16949:2002 ==**



---

---

## WORLDWIDE SALES AND SERVICE

---

---

### AMERICAS

**Corporate Office**  
2355 West Chandler Blvd.  
Chandler, AZ 85224-6199  
Tel: 480-792-7200  
Fax: 480-792-7277  
Technical Support:  
<http://support.microchip.com>  
Web Address:  
[www.microchip.com](http://www.microchip.com)

**Atlanta**  
Duluth, GA  
Tel: 678-957-9614  
Fax: 678-957-1455

**Boston**  
Westborough, MA  
Tel: 774-760-0087  
Fax: 774-760-0088

**Chicago**  
Itasca, IL  
Tel: 630-285-0071  
Fax: 630-285-0075

**Dallas**  
Addison, TX  
Tel: 972-818-7423  
Fax: 972-818-2924

**Detroit**  
Farmington Hills, MI  
Tel: 248-538-2250  
Fax: 248-538-2260

**Kokomo**  
Kokomo, IN  
Tel: 765-864-8360  
Fax: 765-864-8387

**Los Angeles**  
Mission Viejo, CA  
Tel: 949-462-9523  
Fax: 949-462-9608

**Santa Clara**  
Santa Clara, CA  
Tel: 408-961-6444  
Fax: 408-961-6445

**Toronto**  
Mississauga, Ontario,  
Canada  
Tel: 905-673-0699  
Fax: 905-673-6509

### ASIA/PACIFIC

**Asia Pacific Office**  
Suites 3707-14, 37th Floor  
Tower 6, The Gateway  
Harbour City, Kowloon  
Hong Kong  
Tel: 852-2401-1200  
Fax: 852-2401-3431

**Australia - Sydney**  
Tel: 61-2-9868-6733  
Fax: 61-2-9868-6755

**China - Beijing**  
Tel: 86-10-8528-2100  
Fax: 86-10-8528-2104

**China - Chengdu**  
Tel: 86-28-8665-5511  
Fax: 86-28-8665-7889

**China - Fuzhou**  
Tel: 86-591-8750-3506  
Fax: 86-591-8750-3521

**China - Hong Kong SAR**  
Tel: 852-2401-1200  
Fax: 852-2401-3431

**China - Qingdao**  
Tel: 86-532-8502-7355  
Fax: 86-532-8502-7205

**China - Shanghai**  
Tel: 86-21-5407-5533  
Fax: 86-21-5407-5066

**China - Shenyang**  
Tel: 86-24-2334-2829  
Fax: 86-24-2334-2393

**China - Shenzhen**  
Tel: 86-755-8203-2660  
Fax: 86-755-8203-1760

**China - Shunde**  
Tel: 86-757-2839-5507  
Fax: 86-757-2839-5571

**China - Wuhan**  
Tel: 86-27-5980-5300  
Fax: 86-27-5980-5118

**China - Xian**  
Tel: 86-29-8833-7250  
Fax: 86-29-8833-7256

### ASIA/PACIFIC

**India - Bangalore**  
Tel: 91-80-4182-8400  
Fax: 91-80-4182-8422

**India - New Delhi**  
Tel: 91-11-4160-8631  
Fax: 91-11-4160-8632

**India - Pune**  
Tel: 91-20-2566-1512  
Fax: 91-20-2566-1513

**Japan - Yokohama**  
Tel: 81-45-471-6166  
Fax: 81-45-471-6122

**Korea - Gumi**  
Tel: 82-54-473-4301  
Fax: 82-54-473-4302

**Korea - Seoul**  
Tel: 82-2-554-7200  
Fax: 82-2-558-5932 or  
82-2-558-5934

**Malaysia - Penang**  
Tel: 60-4-646-8870  
Fax: 60-4-646-5086

**Philippines - Manila**  
Tel: 63-2-634-9065  
Fax: 63-2-634-9069

**Singapore**  
Tel: 65-6334-8870  
Fax: 65-6334-8850

**Taiwan - Hsin Chu**  
Tel: 886-3-572-9526  
Fax: 886-3-572-6459

**Taiwan - Kaohsiung**  
Tel: 886-7-536-4818  
Fax: 886-7-536-4803

**Taiwan - Taipei**  
Tel: 886-2-2500-6610  
Fax: 886-2-2508-0102

**Thailand - Bangkok**  
Tel: 66-2-694-1351  
Fax: 66-2-694-1350

### EUROPE

**Austria - Wels**  
Tel: 43-7242-2244-39  
Fax: 43-7242-2244-393

**Denmark - Copenhagen**  
Tel: 45-4450-2828  
Fax: 45-4485-2829

**France - Paris**  
Tel: 33-1-69-53-63-20  
Fax: 33-1-69-30-90-79

**Germany - Munich**  
Tel: 49-89-627-144-0  
Fax: 49-89-627-144-44

**Italy - Milan**  
Tel: 39-0331-742611  
Fax: 39-0331-466781

**Netherlands - Drunen**  
Tel: 31-416-690399  
Fax: 31-416-690340

**Spain - Madrid**  
Tel: 34-91-708-08-90  
Fax: 34-91-708-08-91

**UK - Wokingham**  
Tel: 44-118-921-5869  
Fax: 44-118-921-5820



## Стандарт Электрон Связь

Мы молодая и активно развивающаяся компания в области поставок электронных компонентов. Мы поставляем электронные компоненты отечественного и импортного производства напрямую от производителей и с крупнейших складов мира.

Благодаря сотрудничеству с мировыми поставщиками мы осуществляем комплексные и плановые поставки широчайшего спектра электронных компонентов.

Собственная эффективная логистика и склад в обеспечивает надежную поставку продукции в точно указанные сроки по всей России.

Мы осуществляем техническую поддержку нашим клиентам и предпродажную проверку качества продукции. На все поставляемые продукты мы предоставляем гарантию .

Осуществляем поставки продукции под контролем ВП МО РФ на предприятия военно-промышленного комплекса России , а также работаем в рамках 275 ФЗ с открытием отдельных счетов в уполномоченном банке. Система менеджмента качества компании соответствует требованиям ГОСТ ISO 9001.

Минимальные сроки поставки, гибкие цены, неограниченный ассортимент и индивидуальный подход к клиентам являются основой для выстраивания долгосрочного и эффективного сотрудничества с предприятиями радиоэлектронной промышленности, предприятиями ВПК и научно-исследовательскими институтами России.

С нами вы становитесь еще успешнее!

### Наши контакты:

**Телефон:** +7 812 627 14 35

**Электронная почта:** [sales@st-electron.ru](mailto:sales@st-electron.ru)

**Адрес:** 198099, Санкт-Петербург,  
Промышленная ул, дом № 19, литера Н,  
помещение 100-Н Офис 331