



## N-Channel Depletion-Mode Vertical DMOS FETs

### Features

- ▶ High input impedance
- ▶ Low input capacitance
- ▶ Fast switching speeds
- ▶ Low on-resistance
- ▶ Free from secondary breakdown
- ▶ Low input and output leakage

### Applications

- ▶ Normally-on switches
- ▶ Solid state relays
- ▶ Converters
- ▶ Linear amplifiers
- ▶ Constant current sources
- ▶ Power supply circuits
- ▶ Telecom

### General Description

The DN2530 is a low threshold depletion-mode (normally-on) transistor utilizing an advanced vertical DMOS structure and Supertex's well-proven silicon-gate manufacturing process. This combination produces a device with the power handling capabilities of bipolar transistors and with the high input impedance and positive temperature coefficient inherent in MOS devices. Characteristic of all MOS structures, this device is free from thermal runaway and thermally-induced secondary breakdown.

Supertex's vertical DMOS FETs are ideally suited to a wide range of switching and amplifying applications where high breakdown voltage, high input impedance, low input capacitance, and fast switching speeds are desired.

### Ordering Information

Device	Package Options		BV <sub>DSX</sub> / BV <sub>DGX</sub> (V)	R <sub>DS(ON)</sub> (max) (Ω)	I <sub>DSS</sub> (min) (mA)
	TO-243AA (SOT-89)	TO-92			
DN2530	DN2530N8-G	DN2530N3-G	300	12	200

-G indicates package is RoHS compliant ('Green')



### Absolute Maximum Ratings

Parameter	Value
Drain-to-source voltage	BV <sub>DSX</sub>
Drain-to-gate voltage	BV <sub>DGX</sub>
Gate-to-source voltage	±20V
Operating and storage temperature	-55°C to +150°C
Soldering temperature*	300°C

Absolute Maximum Ratings are those values beyond which damage to the device may occur. Functional operation under these conditions is not implied. Continuous operation of the device at the absolute rating level may affect device reliability. All voltages are referenced to device ground.

\* Distance of 1.6mm from case for 10 seconds.

### Pin Configurations

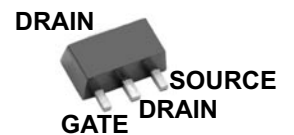
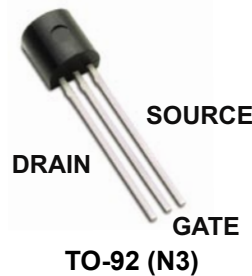

### Product Marking

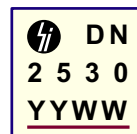

YY = Year Sealed  
 WW = Week Sealed  
 \_\_\_\_\_ = "Green" Packaging

TO-92 (N3)

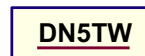

W = Code for week sealed  
 \_\_\_\_\_ = "Green" Packaging

TO-243AA (SOT-89) (N8)

### Thermal Characteristics

Package	$I_D$ (continuous) <sup>†</sup> (mA)	$I_D$ (pulsed) (mA)	Power Dissipation @ $T_A = 25^\circ\text{C}$ (W)	$\theta_{jc}$ ( $^\circ\text{C}/\text{W}$ )	$\theta_{ja}$ ( $^\circ\text{C}/\text{W}$ )	$I_{DR}$ <sup>†</sup> (mA)	$I_{DRM}$ (mA)
TO-243AA	200	500	1.6 <sup>‡</sup>	15	78 <sup>‡</sup>	200	500
TO-92	175	500	0.74	125	170	175	500

**Notes:**

- <sup>†</sup>  $I_D$  (continuous) is limited by max rated  $T_j$ .
- <sup>‡</sup> Mounted on FR4 board, 25mm x 25mm x 1.57mm.

### Electrical Characteristics ( $T_A = 25^\circ\text{C}$ unless otherwise specified)

Sym	Parameter	Min	Typ	Max	Units	Conditions
$BV_{DSX}$	Drain-to-source breakdown voltage	300	-	-	V	$V_{GS} = -5.0\text{V}, I_D = 100\mu\text{A}$
$V_{GS(OFF)}$	Gate-to-source off voltage	-1.0	-	-3.5	V	$V_{DS} = 25\text{V}, I_D = 10\mu\text{A}$
$\Delta V_{GS(OFF)}$	Change in $V_{GS(OFF)}$ with temperature	-	-	-4.5	mV/ $^\circ\text{C}$	$V_{DS} = 25\text{V}, I_D = 10\mu\text{A}$
$I_{GSS}$	Gate body leakage current	-	-	100	nA	$V_{GS} = \pm 20\text{V}, V_{DS} = 0\text{V}$
$I_{D(OFF)}$	Drain-to-source leakage current	-	-	10	$\mu\text{A}$	$V_{DS} = \text{Max rating}, V_{GS} = -10\text{V}$
		-	-	1.0	mA	$V_{DS} = 0.8 \text{ Max Rating}, V_{GS} = -10\text{V}, T_A = 125^\circ\text{C}$
$I_{DSS}$	Saturated drain-to-source current	200	-	-	mA	$V_{GS} = 0\text{V}, V_{DS} = 25\text{V}$
$R_{DS(ON)}$	Static drain-to-source on-state resistance	-	-	12	$\Omega$	$V_{GS} = 0\text{V}, I_D = 150\text{mA}$
$\Delta R_{DS(ON)}$	Change in $R_{DS(ON)}$ with temperature	-	-	1.1	%/ $^\circ\text{C}$	$V_{GS} = 0\text{V}, I_D = 150\text{mA}$
$G_{FS}$	Forward transconductance	300	-	-	mmho	$V_{DS} = 10\text{V}, I_D = 150\text{mA}$
$C_{ISS}$	Input capacitance	-	-	300	pF	$V_{GS} = -10\text{V}, V_{DS} = 25\text{V}, f = 1\text{MHz}$
$C_{OSS}$	Common source output capacitance	-	-	30		
$C_{RSS}$	Reverse transfer capacitance	-	-	5		
$t_{d(ON)}$	Turn-on delay time	-	-	10	ns	$V_{DD} = 25\text{V}, I_D = 150\text{mA}, R_{GEN} = 25\Omega,$
$t_r$	Rise time	-	-	15		
$t_{d(OFF)}$	Turn-off delay time	-	-	15		
$t_f$	Fall time	-	-	20		
$V_{SD}$	Diode forward voltage drop	-	-	1.8	V	$V_{GS} = -10\text{V}, I_{SD} = 150\text{mA}$
$t_{rr}$	Reverse recovery time	-	600	-	ns	$V_{GS} = -10\text{V}, I_{SD} = 1.0\text{A}$

**Notes:**

- All D.C. parameters 100% tested at  $25^\circ\text{C}$  unless otherwise stated. (Pulse test: 300 $\mu\text{s}$  pulse, 2% duty cycle.)
- All A.C. parameters sample tested.

### Switching Waveforms and Test Circuit

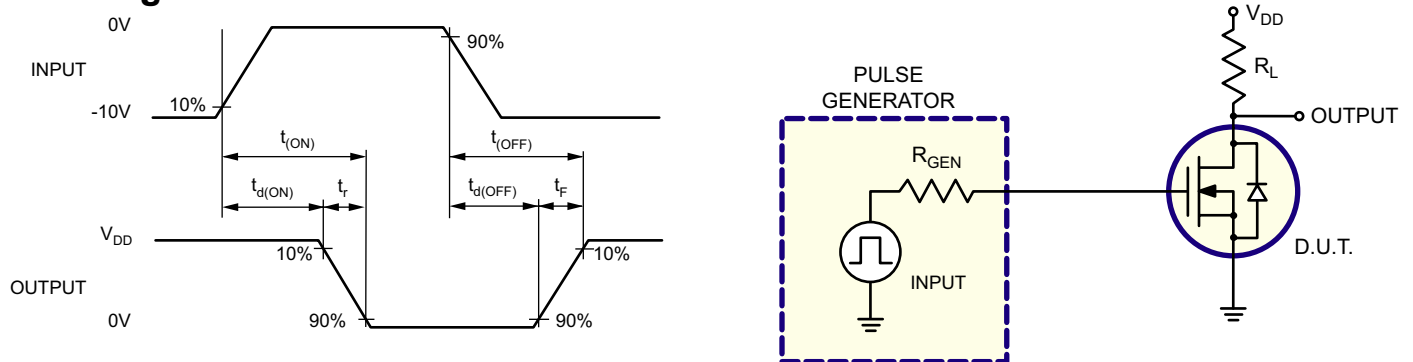

# Typical Performance Curves

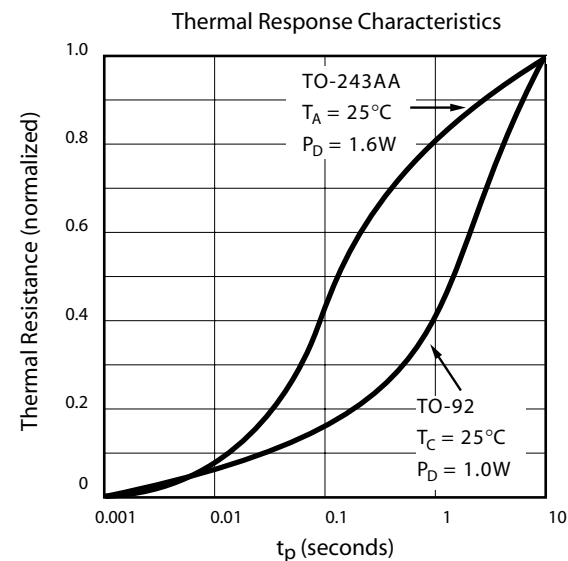
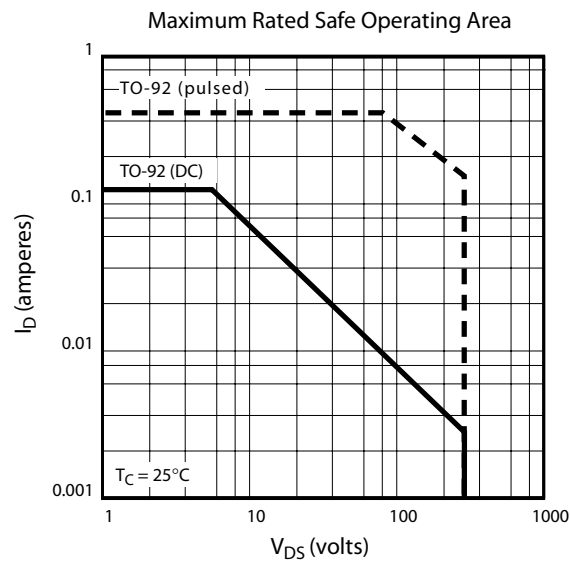
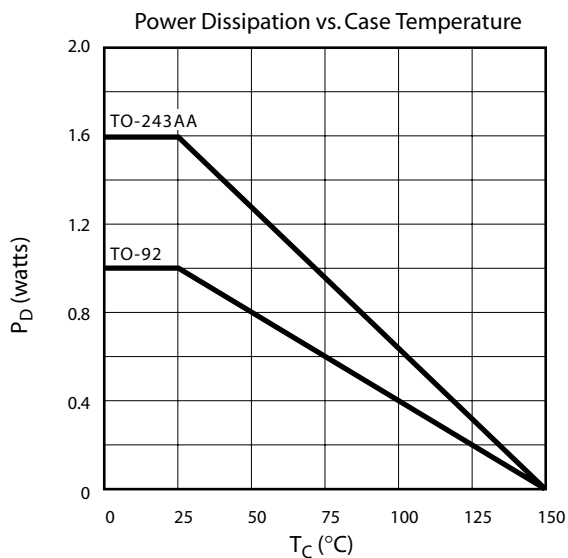
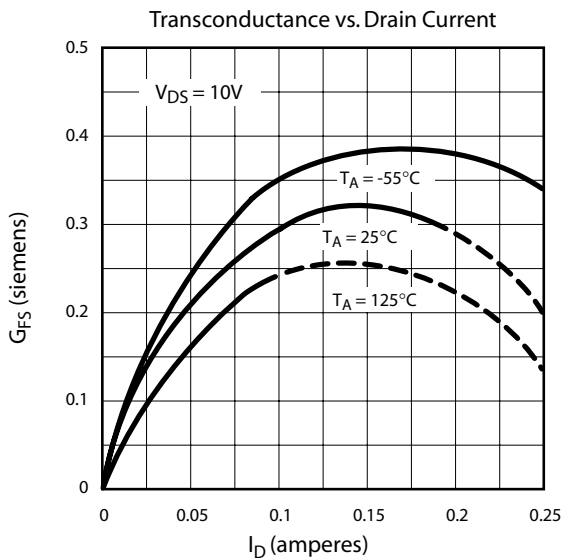
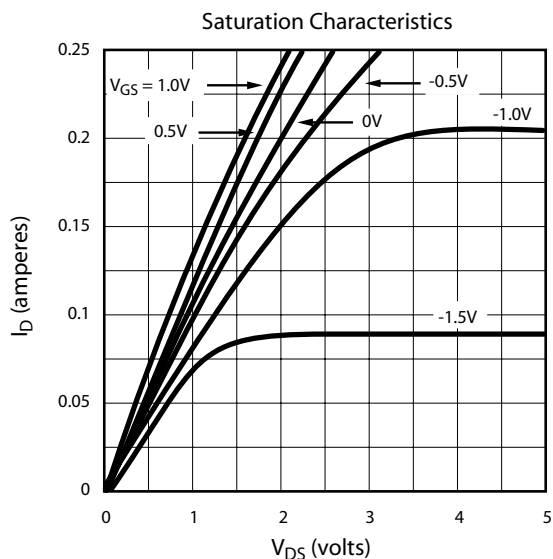
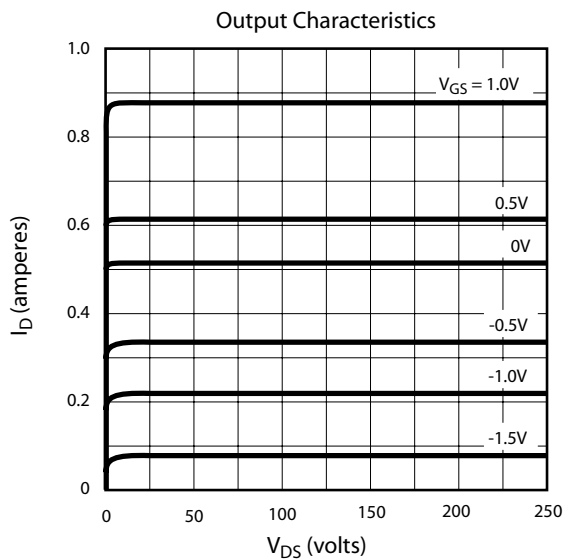

Typical Performance Curves (cont.)

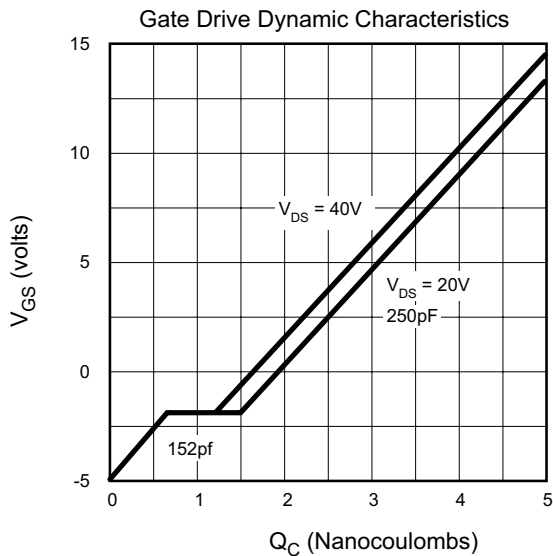
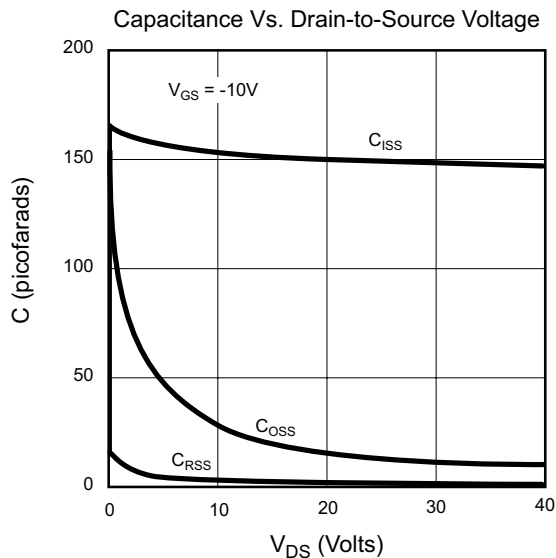
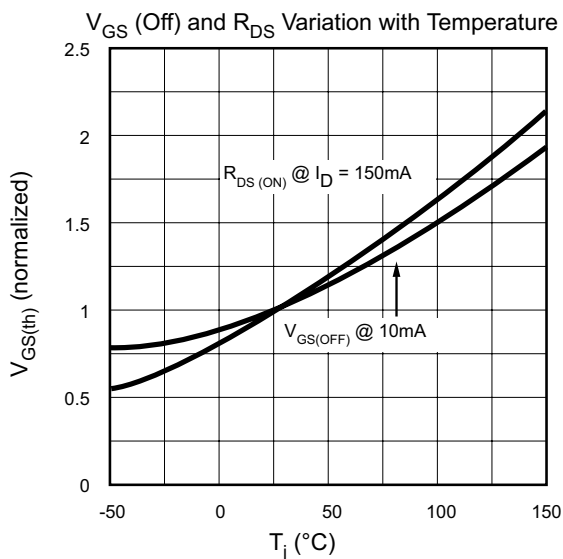
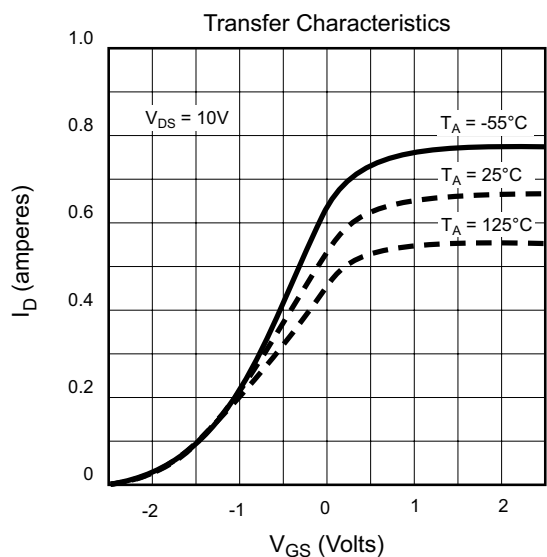
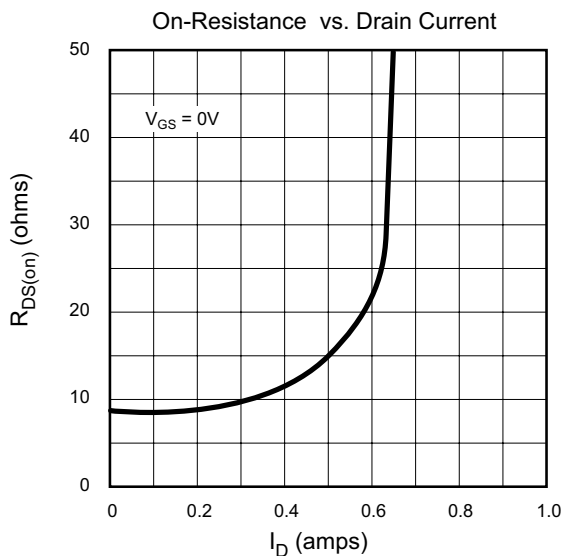
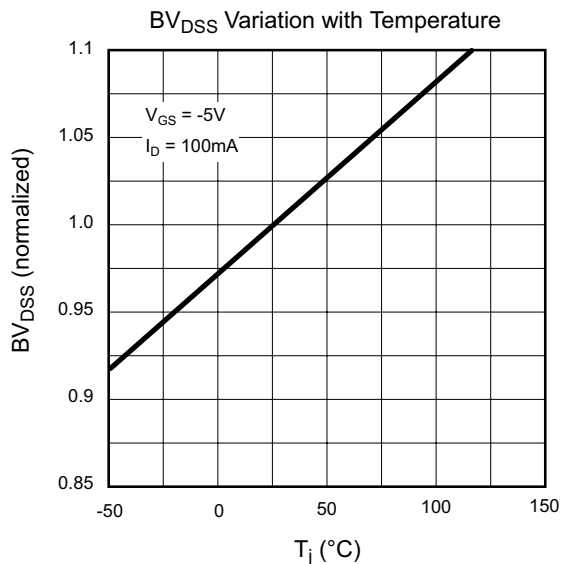

### 3-Lead TO-92 Package Outline (N3)

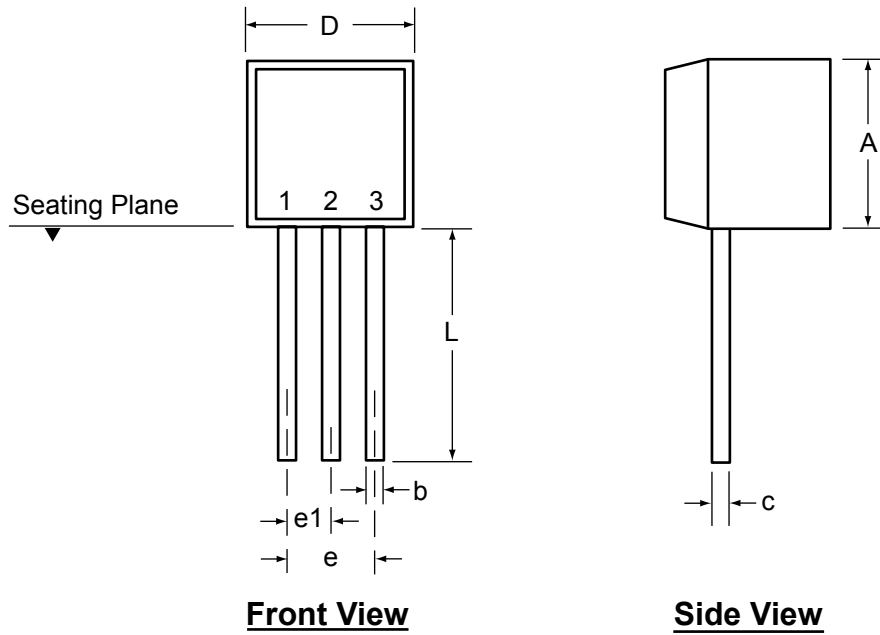

Symbol	A	b	c	D	E	E1	e	e1	L	
Dimensions (inches)	MIN	.170	.014 <sup>†</sup>	.014 <sup>†</sup>	.175	.125	.080	.095	.045	.500
	NOM	-	-	-	-	-	-	-	-	-
	MAX	.210	.022 <sup>†</sup>	.022 <sup>†</sup>	.205	.165	.105	.105	.055	.610*

JEDEC Registration TO-92.

\* This dimension is not specified in the original JEDEC drawing. The value listed is for reference only.

† This dimension is a non-JEDEC dimension.

Drawings not to scale.

Supertex Doc.#: DSPD-3TO92N3, Version D080408.

### 3-Lead TO-243AA (SOT-89) Package Outline (N8)

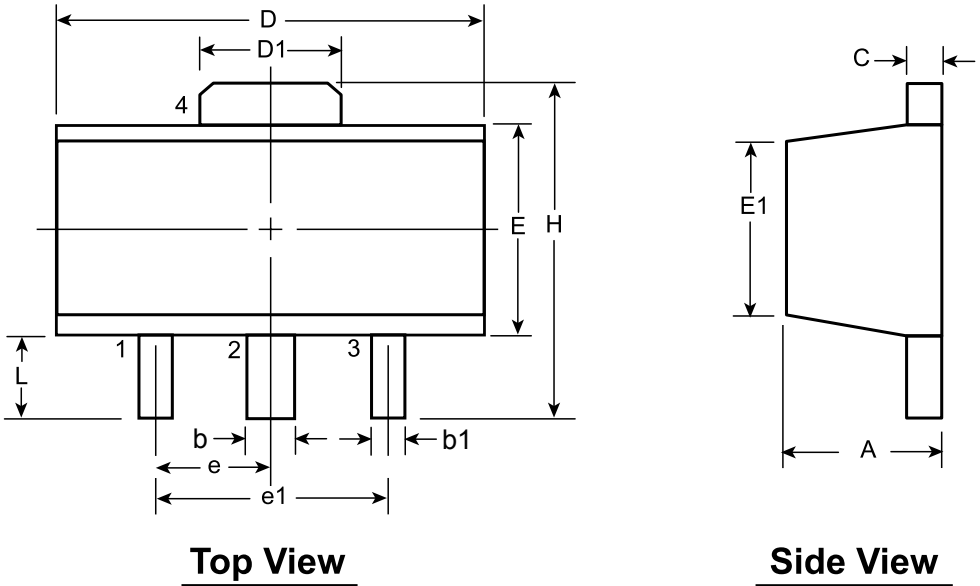

**Top View**

**Side View**

Symbol		A	b	b1	C	D	D1	E	E1	e	e1	H	L
Dimensions (mm)	MIN	1.40	0.44	0.36	0.35	4.40	1.62	2.29	2.13	1.50 BSC	3.00 BSC	3.94	0.89
	NOM	-	-	-	-	-	-	-	-			-	-
	MAX	1.60	0.56	0.48	0.44	4.60	1.83	2.60	2.29			4.25	1.20

JEDEC Registration TO-243, Variation AA, Issue C, July 1986.

Drawings not to scale.

Supertex Doc. #: DSPD-3TO243AAN8, Version D070908.

(The package drawing(s) in this data sheet may not reflect the most current specifications. For the latest package outline information go to <http://www.supertex.com/packaging.html>.)

Supertex inc. does not recommend the use of its products in life support applications, and will not knowingly sell them for use in such applications unless it receives an adequate "product liability indemnification insurance agreement." Supertex inc. does not assume responsibility for use of devices described, and limits its liability to the replacement of the devices determined defective due to workmanship. No responsibility is assumed for possible omissions and inaccuracies. Circuitry and specifications are subject to change without notice. For the latest product specifications refer to the Supertex inc. website: <http://www.supertex.com>.



## Стандарт Электрон Связь

Мы молодая и активно развивающаяся компания в области поставок электронных компонентов. Мы поставляем электронные компоненты отечественного и импортного производства напрямую от производителей и с крупнейших складов мира.

Благодаря сотрудничеству с мировыми поставщиками мы осуществляем комплексные и плановые поставки широчайшего спектра электронных компонентов.

Собственная эффективная логистика и склад в обеспечивает надежную поставку продукции в точно указанные сроки по всей России.

Мы осуществляем техническую поддержку нашим клиентам и предпродажную проверку качества продукции. На все поставляемые продукты мы предоставляем гарантию .

Осуществляем поставки продукции под контролем ВП МО РФ на предприятия военно-промышленного комплекса России , а также работаем в рамках 275 ФЗ с открытием отдельных счетов в уполномоченном банке. Система менеджмента качества компании соответствует требованиям ГОСТ ISO 9001.

Минимальные сроки поставки, гибкие цены, неограниченный ассортимент и индивидуальный подход к клиентам являются основой для выстраивания долгосрочного и эффективного сотрудничества с предприятиями радиоэлектронной промышленности, предприятиями ВПК и научно-исследовательскими институтами России.

С нами вы становитесь еще успешнее!

### Наши контакты:

**Телефон:** +7 812 627 14 35

**Электронная почта:** [sales@st-electron.ru](mailto:sales@st-electron.ru)

**Адрес:** 198099, Санкт-Петербург,  
Промышленная ул, дом № 19, литера Н,  
помещение 100-Н Офис 331