

DATA SHEET

AS179-92LF: 20 MHz-3.0 GHz GaAs SPDT Switch

Applications

- General purpose medium-power switches in telecommunication applications
- Transmit/receive switches in 802.11 b/g WLAN Bluetooth™ systems

Features

- IP1dB = +30 dBm typical @ 3 V
- IP3 = +43 dBm typical @ 3 V
- Low insertion loss, 0.3 dB @ 0.9 GHz
- Low DC power consumption
- Ultra-miniature, SC-70 (6-pin, 2.00 x 1.25 mm) package (MSL1, 260 °C per JEDEC J-STD-020)

NEW



Skyworks Green™ products are RoHS (Restriction of Hazardous Substances)-compliant, conform to the EIA/EICTA/JEITA Joint Industry Guide (JIG) Level A guidelines, are halogen free according to IEC-61249-2-21, and contain <1,000 ppm antimony trioxide in polymeric materials.

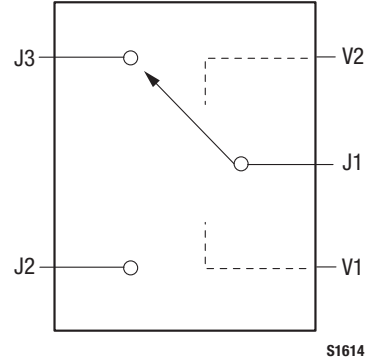

Figure 1. AS179-92LF Block Diagram

Description

The AS179-92LF is a pHEMT GaAs FET Single Pole Double Throw (SPDT) switch. The device features low insertion loss and positive voltage operation with very low DC power consumption. The AS179-92LF is manufactured in a compact, low-cost 2.00 x 1.25 mm, 6-pin SC-70 package.

A functional block diagram is shown in Figure 1. The pin configuration and package are shown in Figure 2. Signal pin assignments and functional pin descriptions are provided in Table 1.

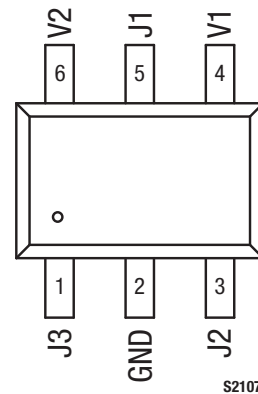

Figure 2. AS179-92LF Pinout –6-Pin SC-70 (Top View)

Table 1. AS179-92LF Signal Descriptions

Pin #	Name	Description	Pin #	Name	Description
1	J3	RF output (Note 1)	4	V1	DC control voltage
2	GND	Ground	5	J1	RF output (Note 1)
3	J2	RF output (Note 1)	6	V2	DC control voltage

Note 1: A 100 pF blocking capacitor is required for >500 MHz operation. Use larger value capacitors for lower frequency operation.

Table 2. AS179-92LF Absolute Maximum Ratings

Parameter	Symbol	Minimum	Maximum	Units
Control voltage	V _{CTL}	-0.2	+8.0	V
RF input power (V _{CTL} = 0-7 V): >500 MHz <500 MHz			6 500	W mW
Operating temperature	T _{OP}	-40	+85	°C
Storage temperature	T _{STG}	-65	+150	°C

Note: Exposure to maximum rating conditions for extended periods may reduce device reliability. There is no damage to device with only one parameter set at the limit and all other parameters set at or below their nominal value.

CAUTION: Although this device is designed to be as robust as possible, Electrostatic Discharge (ESD) can damage this device. This device must be protected at all times from ESD. Static charges may easily produce potentials of several kilovolts on the human body or equipment, which can discharge without detection. Industry-standard ESD precautions should be used at all times.

Table 3. AS179-92LF Electrical Specifications (1 of 2) (Note 1)

(V_{CTL} = 0-3 V, T_{OP} = +25 °C, Characteristic Impedance = 50 Ω, Unless Otherwise Noted)

Parameter	Symbol	Test Condition	Min	Typical	Max	Units
Insertion loss (Note 2, Note 3)		0.02 to 1.0 GHz		0.3	0.4	dB
		1.0 to 2.0 GHz		0.4	0.5	dB
		2.0 to 3.0 GHz		0.4	0.6	dB
Isolation (Note 3)		0.02 to 1.0 GHz	22	25		dB
		1.0 to 2.0 GHz	22	25		dB
		2.0 to 3.0 GHz	20	23		dB
Voltage Standing Wave Ratio (Note 3, Note 4)	VSWR	0.02 to 1.0 GHz		1.2:1	1.4:1	-
		1.0 to 2.0 GHz		1.2:1	1.4:1	-
		2.0 to 3.0 GHz		1.3:1	1.45:1	-
Switching characteristics: Rise/fall On/off Video feedthrough		10/90% or 90/10% RF		10		ns
		50% control to 90/10% RF		100		ns
		T _{RISE} = 1 ns, bandwidth = 500 MHz		25		mV
1 dB Input Compression Point	IP1dB	@ 0.5 to 3.0 GHz				
		V _{CTL} = 0 to 2 V		+26		dBm
		V _{CTL} = 0 to 3 V		+30		dBm
		V _{CTL} = 0 to 5 V		+34		dBm
		@ 48 MHz				
		V _{CTL} = 0 to 3 V		+28.9		dBm
V _{CTL} = 0 to 5 V		+29.5		dBm		

Table 3. AS179-92LF Electrical Specifications (2 of 2) (Note 1)
($V_{CTL} = 0-3\text{ V}$, $T_{OP} = +25\text{ }^{\circ}\text{C}$, Characteristic Impedance = $50\ \Omega$, Unless Otherwise Noted)

Parameter	Symbol	Test Condition	Min	Typical	Max	Units
3 rd Order Intercept Point	IP3	+5 dBm two-tone input power @ 0.5 to 3.0 GHz $V_{CTL} = 0\text{ to }2\text{ V}$ $V_{CTL} = 0\text{ to }3\text{ V}$ $V_{CTL} = 0\text{ to }5\text{ V}$		+43 +43 +50		dBm dBm dBm
Thermal resistance				25		$^{\circ}\text{C}/\text{W}$
Control voltage: Low (@ 20 μA max) High (@100 μA max) High (@ 200 μA max)	V_{CTL_L} V_{CTL_H} V_{CTL_H}		0		0.2 2.0 5.0	V V V

Note 1: Performance is guaranteed only under the conditions listed in this Table.

Note 2: Insertion loss changes by 0.003 dB/ $^{\circ}\text{C}$.

Note 3: Typical performance maintained with $V_{CTL} = 0.2\text{ V}$.

Note 4: Insertion loss state.

Typical Performance Characteristics

($V_{CTL} = 0-3\text{ V}$, $T_{OP} = +25\text{ }^{\circ}\text{C}$, $P_{IN} = 0\text{ dBm}$, Characteristic Impedance [Z_0] = $50\ \Omega$, $C_{BL} = 100\text{ pF}$, Unless Otherwise Noted)

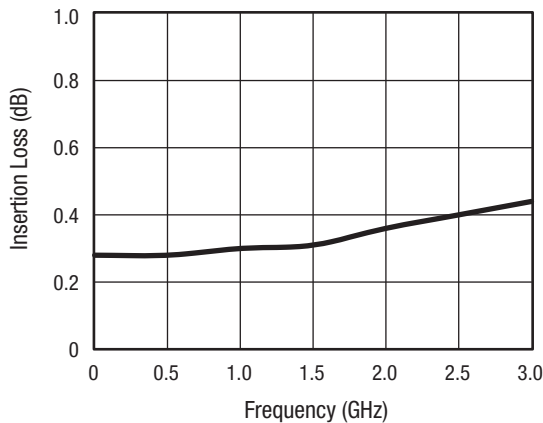

Figure 2. Insertion Loss vs Frequency

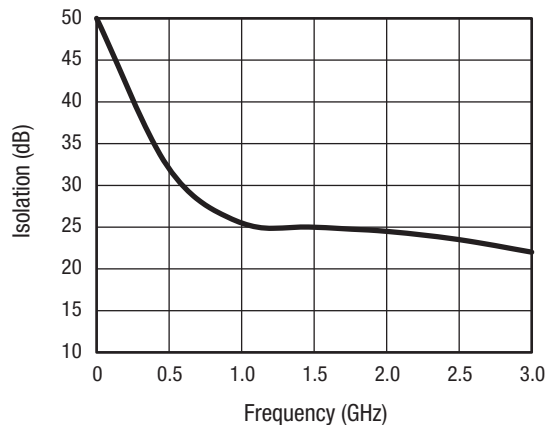

Figure 3. Isolation vs Frequency

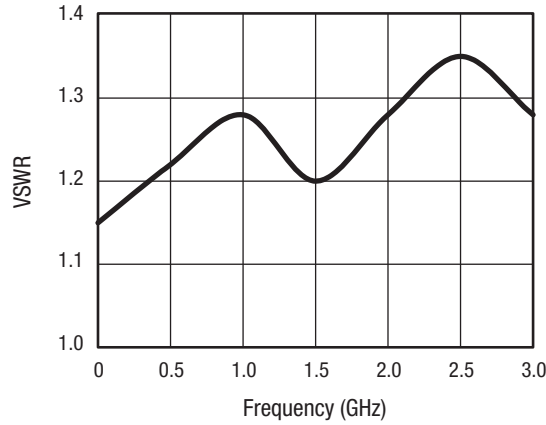

Figure 4. VSWR vs Frequency

Table 4. Truth Table (V_{HIGH} = 2 to 5 V)

V1	V2	J1-J2	J1-J3
V _{HIGH}	0	Isolation	Insertion loss
0	V _{HIGH}	Insertion loss	Isolation

Note: Any state other than described in this Table places the device in an undefined state. An undefined state does not damage the device.

Evaluation Board Description

The AS179-92LF Evaluation Board is used to test the performance of the AS179-92LF SPDT switch. An Evaluation Board schematic diagram is provided in Figure 5. An assembly drawing for the Evaluation Board is shown in Figure 6.

Package Dimensions

Package dimensions for the 6-pin SC-70 are shown in Figure 7, and tape and reel dimensions are provided in Figure 8.

Package and Handling Information

Instructions on the shipping container label regarding exposure to moisture after the container seal is broken must be followed. Otherwise, problems related to moisture absorption may occur when the part is subjected to high temperature during solder assembly.

The AS179-92LF is rated to Moisture Sensitivity Level 1 (MSL1) at 260 °C. It can be used for lead or lead-free soldering.

Care must be taken when attaching this product, whether it is done manually or in a production solder reflow environment. Production quantities of this product are shipped in a standard tape and reel format.

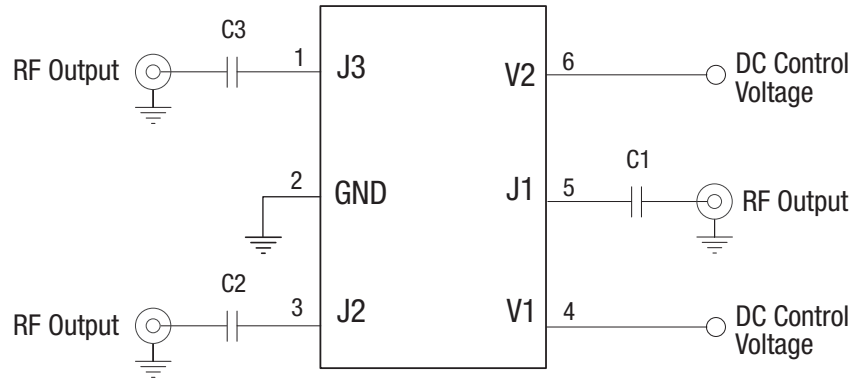

Note: Use 100 pF blocking capacitors (C1, C2, C3) for >500 MHz operation. Higher values recommended for lower frequency operation. Exposed paddle must be grounded.
 Use 10 nF blocking capacitors (C1, C2, C3) for <50 MHz operation.

S2108

Figure 5. AS179-92LF Evaluation Board Schematic

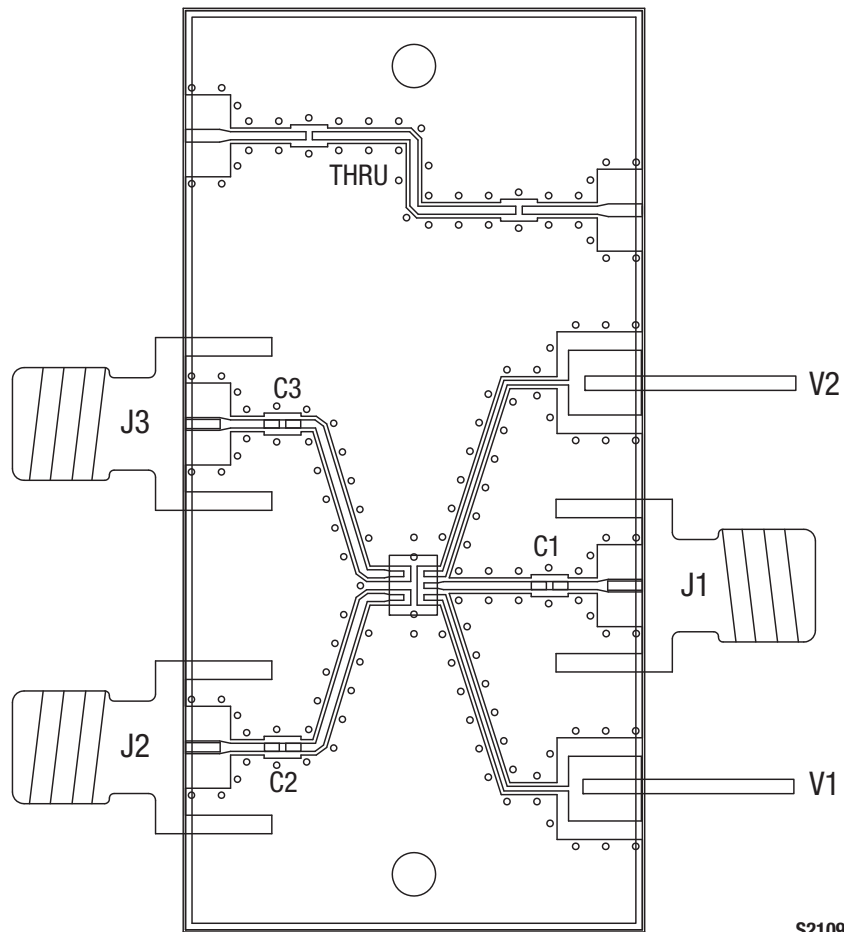

S2109

Figure 6. AS179-92LF Evaluation Board Assembly Diagram

Ordering Information

Model Name	Manufacturing Part Number	Evaluation Board Part Number
AS179-92LF SPDT Switch	AS179-92LF	AS179-92LF-EVB

Copyright © 2008-2010 Skyworks Solutions, Inc. All Rights Reserved.

Information in this document is provided in connection with Skyworks Solutions, Inc. ("Skyworks") products or services. These materials, including the information contained herein, are provided by Skyworks as a service to its customers and may be used for informational purposes only by the customer. Skyworks assumes no responsibility for errors or omissions in these materials or the information contained herein. Skyworks may change its documentation, products, services, specifications or product descriptions at any time, without notice. Skyworks makes no commitment to update the materials or information and shall have no responsibility whatsoever for conflicts, incompatibilities, or other difficulties arising from any future changes.

No license, whether express, implied, by estoppel or otherwise, is granted to any intellectual property rights by this document. Skyworks assumes no liability for any materials, products or information provided hereunder, including the sale, distribution, reproduction or use of Skyworks products, information or materials, except as may be provided in Skyworks Terms and Conditions of Sale.

THE MATERIALS, PRODUCTS AND INFORMATION ARE PROVIDED "AS IS" WITHOUT WARRANTY OF ANY KIND, WHETHER EXPRESS, IMPLIED, STATUTORY, OR OTHERWISE, INCLUDING FITNESS FOR A PARTICULAR PURPOSE OR USE, MERCHANTABILITY, PERFORMANCE, QUALITY OR NON-INFRINGEMENT OF ANY INTELLECTUAL PROPERTY RIGHT; ALL SUCH WARRANTIES ARE HEREBY EXPRESSLY DISCLAIMED. SKYWORKS DOES NOT WARRANT THE ACCURACY OR COMPLETENESS OF THE INFORMATION, TEXT, GRAPHICS OR OTHER ITEMS CONTAINED WITHIN THESE MATERIALS. SKYWORKS SHALL NOT BE LIABLE FOR ANY DAMAGES, INCLUDING BUT NOT LIMITED TO ANY SPECIAL, INDIRECT, INCIDENTAL, STATUTORY, OR CONSEQUENTIAL DAMAGES, INCLUDING WITHOUT LIMITATION, LOST REVENUES OR LOST PROFITS THAT MAY RESULT FROM THE USE OF THE MATERIALS OR INFORMATION, WHETHER OR NOT THE RECIPIENT OF MATERIALS HAS BEEN ADVISED OF THE POSSIBILITY OF SUCH DAMAGE.

Skyworks products are not intended for use in medical, lifesaving or life-sustaining applications, or other equipment in which the failure of the Skyworks products could lead to personal injury, death, physical or environmental damage. Skyworks customers using or selling Skyworks products for use in such applications do so at their own risk and agree to fully indemnify Skyworks for any damages resulting from such improper use or sale.

Customers are responsible for their products and applications using Skyworks products, which may deviate from published specifications as a result of design defects, errors, or operation of products outside of published parameters or design specifications. Customers should include design and operating safeguards to minimize these and other risks. Skyworks assumes no liability for applications assistance, customer product design, or damage to any equipment resulting from the use of Skyworks products outside of stated published specifications or parameters.

Skyworks, the Skyworks symbol, and "Breakthrough Simplicity" are trademarks or registered trademarks of Skyworks Solutions, Inc., in the United States and other countries. Third-party brands and names are for identification purposes only, and are the property of their respective owners. Additional information, including relevant terms and conditions, posted at www.skyworksinc.com, are incorporated by reference.



Стандарт Электрон Связь

Мы молодая и активно развивающаяся компания в области поставок электронных компонентов. Мы поставляем электронные компоненты отечественного и импортного производства напрямую от производителей и с крупнейших складов мира.

Благодаря сотрудничеству с мировыми поставщиками мы осуществляем комплексные и плановые поставки широчайшего спектра электронных компонентов.

Собственная эффективная логистика и склад в обеспечивает надежную поставку продукции в точно указанные сроки по всей России.

Мы осуществляем техническую поддержку нашим клиентам и предпродажную проверку качества продукции. На все поставляемые продукты мы предоставляем гарантию .

Осуществляем поставки продукции под контролем ВП МО РФ на предприятия военно-промышленного комплекса России , а также работаем в рамках 275 ФЗ с открытием отдельных счетов в уполномоченном банке. Система менеджмента качества компании соответствует требованиям ГОСТ ISO 9001.

Минимальные сроки поставки, гибкие цены, неограниченный ассортимент и индивидуальный подход к клиентам являются основой для выстраивания долгосрочного и эффективного сотрудничества с предприятиями радиоэлектронной промышленности, предприятиями ВПК и научно-исследовательскими институтами России.

С нами вы становитесь еще успешнее!

Наши контакты:

Телефон: +7 812 627 14 35

Электронная почта: sales@st-electron.ru

Адрес: 198099, Санкт-Петербург,
Промышленная ул, дом № 19, литера Н,
помещение 100-Н Офис 331