

ADVANTECH

# ADVANTECH

## DRAM Memory Module

### Portfolio Introduction

PAPS Product Management  
Q3 / 2013

**PART I.**

**ADVANTECH QUALIFIED DIMM  
(AQD)**

# ADVANTECH QUALIFIED DIMM

***Built to Last ---***

The toughest memory module for rigorous applications



**QUALITY**



**RELIABILITY**

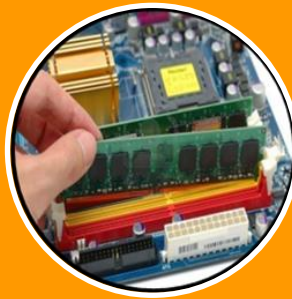

**COMPATIBIL  
ITY**



**LONGEVITY**



**LIFE-TIME  
WARRANTY**



**Quality Assurance**

Rigorous Reliability Tests

Cross-Checked Compatibility

Longevity

Life-Time Warranty

# Quality Assurance Program

Carefully Selected Premium Materials

ISO-9000 Manufacturing Process

Industrial Testing Standard

Quality Assurance

**Rigorous  
Reliability  
Tests**

Cross-Checked  
Compatibility

Longevity

Life-Time Warranty

100% Module  
On Board  
Testing

Vibration  
Test

Chamber Test

Functional Test

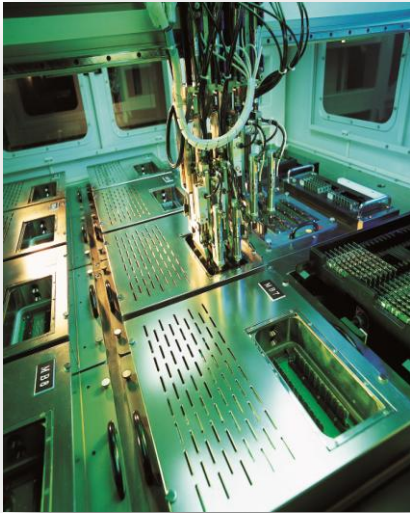

Quality Assurance

Rigorous Reliability Tests

**Cross-Checked Compatibility**

Longevity

Life-Time Warranty

Motherboard Team  
DOA Testing Result

Memory Compatibility  
Testing Result

**Check & Compare**  
Both Teams Testing Result to  
Ensure M/B vs. Memory  
Compatibility



Part No	9603-1G1069N-N-AP	9603-1G1069N-N-TR	9603-2C1069N-N-AP	9603-2C1069N-N-TR	9603-4G1069N-N-AP	9603-1G1333N-N-AP	9603-1G1333N-N-AP1	9603-1G1333N-N-SA	9603-1G1333N-N-TR	9603-1G1333N-N-TR1	9603-2C1333N-N-AP
ARK-DS302-S6A1E											
ARK-DS302-S6A1E											
ARK-DS302-S6A2E											
ARK-DS302-S6A2E											
ARK-DS350-00A1E											
ARK-DS350-00B1E											
ARK-DS350-U0A1E											
ARK-DS350-U2A1E											
ARK-DS350-U7B1E											
ARK-DS350-USB1E											
ASMB-310-00A1E											
ASMB-310R-00A1E											
ASMB-781G2-00A1E	x	x	x	x	x	x	x	x	x	x	x
ASMB-781G4-00A1E	x	x	x	x	x	x	x	x	x	x	x
ASMB-920-00A1E											
ASMB-920R-00A1E											
FWA-3210A											
FWA-3210B											
FWA-6500BE											

Quality Assurance

Rigorous Reliability  
Tests

Cross-Checked  
Compatibility

**Longevity**

Life-Time Warranty

## Locked BOM

- IC Spec
- PCB Layout



**Minimum  
3 Years  
Longevity**

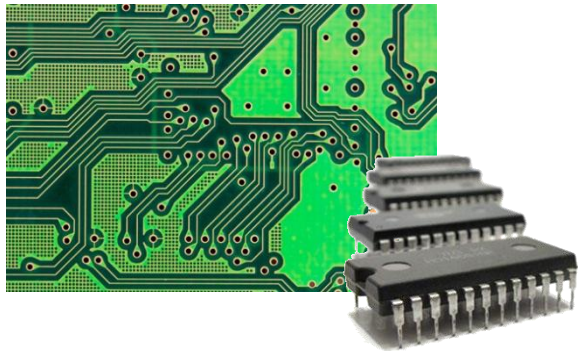



Quality Assurance

Rigorous Reliability  
Tests

Cross-Checked  
Compatibility

Longevity

**Life-Time Warranty**

**Every ADVATECH QUALIFIED  
DIMM (AQD) is back up by life-  
time warranty.**





# AQD Product Portfolio



## *Unbuffered DIMM*

- \* General IPC Applications
- \* 1GB, 2GB, 4GB & 8GB

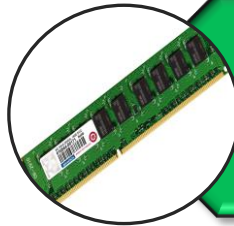

## *ECC Unbuffered DIMM*

- \* Improve system productivity and efficiency
- \* 4GB & 8GB

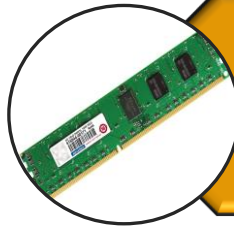

## *Registered DIMM*

- \* Providing the best solution for capacity and performance requirement.
- \* 8 GB & 16GB

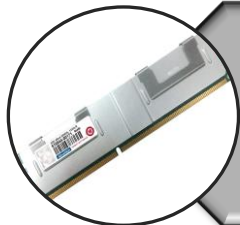

## *Load Reduce DIMM*

- \* Providing the biggest capacity per server with the lowest energy costs
- \* 32GB

# AQD Products Offering

**LONG & SHORT  
Unbuffered DIMM**

LONG DIMM  
DDR3-1333  
1G



AQD-D31GN13-SX

LONG DIMM  
DDR3-1600  
2G



AQD-D3L2GN16-SQ

LONG DIMM  
DDR3-1600  
4G



AQD-D3L4GN16-SQ

LONG DIMM  
DDR3-1600  
8G



AQD-D3L8GN16-SQ

SHORT DIMM  
DDR3-1333  
1G



AQD-SD31GN13-SX

SHORT DIMM  
DDR3-1600  
2G



AQD-SD3L2GN16-SQ

SHORT DIMM  
DDR3-1600  
4G



AQD-SD3L4GN16-SG

SHORT DIMM  
DDR3-1600  
8G



AQD-SD3L8GN16-SG

**ECC Unbuffered DIMM**

LONG DIMM  
DDR3-1600  
4G



AQD-D3L4GE16-SG

LONG DIMM  
DDR3-1600  
8G



AQD-D3L8GE16-SG

**Load Reduce DIMM**

DDR3-1333  
32G



AQD-D3L32L13-SM

**Registered DIMM**

LONG DIMM  
DDR3-1600  
8G



AQD-D3L8GRV16-SG

LONG DIMM  
DDR3-1600  
16GB



AQD-D3L16RV16-SM

# Part Number Decoder

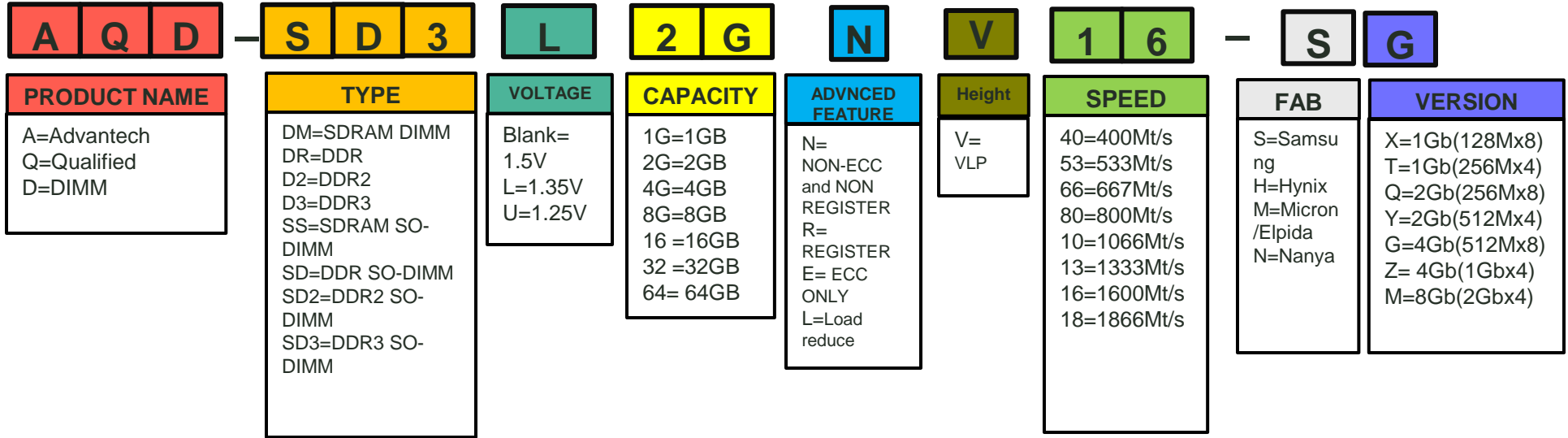

## Color / Symbol Key

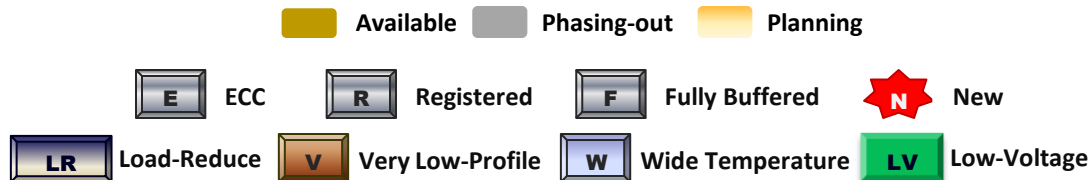

# AQD DDR3 Memory Modules Portfolio

DDR3 1.35 Low Voltage		1333		1600	
		LONG	SHORT	LONG	SHORT
U-DIMM	1GB (128X8)	AQD-D31GN13-SX (1.5V)	AQD-SD31GN13-SX (1.5V)		
	2GB (256MX8)			AQD-D3L2GN16-SQ	AQD-SD3L2GN16-SQ
	4GB (512MX8)			AQD-D3L4GN16-SG	AQD-SD3L4GN16-SG
	8GB (512MX8)			AQD-D3L8GN16-SG	AQD-SD3L8GN16-SG
ECC U-DIMM	4GB (512MX8)			AQD-D3L4GE16-SG	
	8GB (512MX8)			AQD-D3L8GE16-SG	
R-DIMM	4GB (512MX8)				
	8GB (512MX8)			AQD-D3L8GRV16-SG	
	16GB(2Gbx4)			AQD-D3L16RV16-SM	
LOAD REDUCE	32GB (2GbX4)	AQD-D3L32L13-SM			

# DDR3 DIMM

E ECC   
 R Registered   
 F Fully Buffered   
 N New  
LR Load-Reduce   
 V Very Low-Profile   
 W Wide Temperature   
 LV Low-Voltage

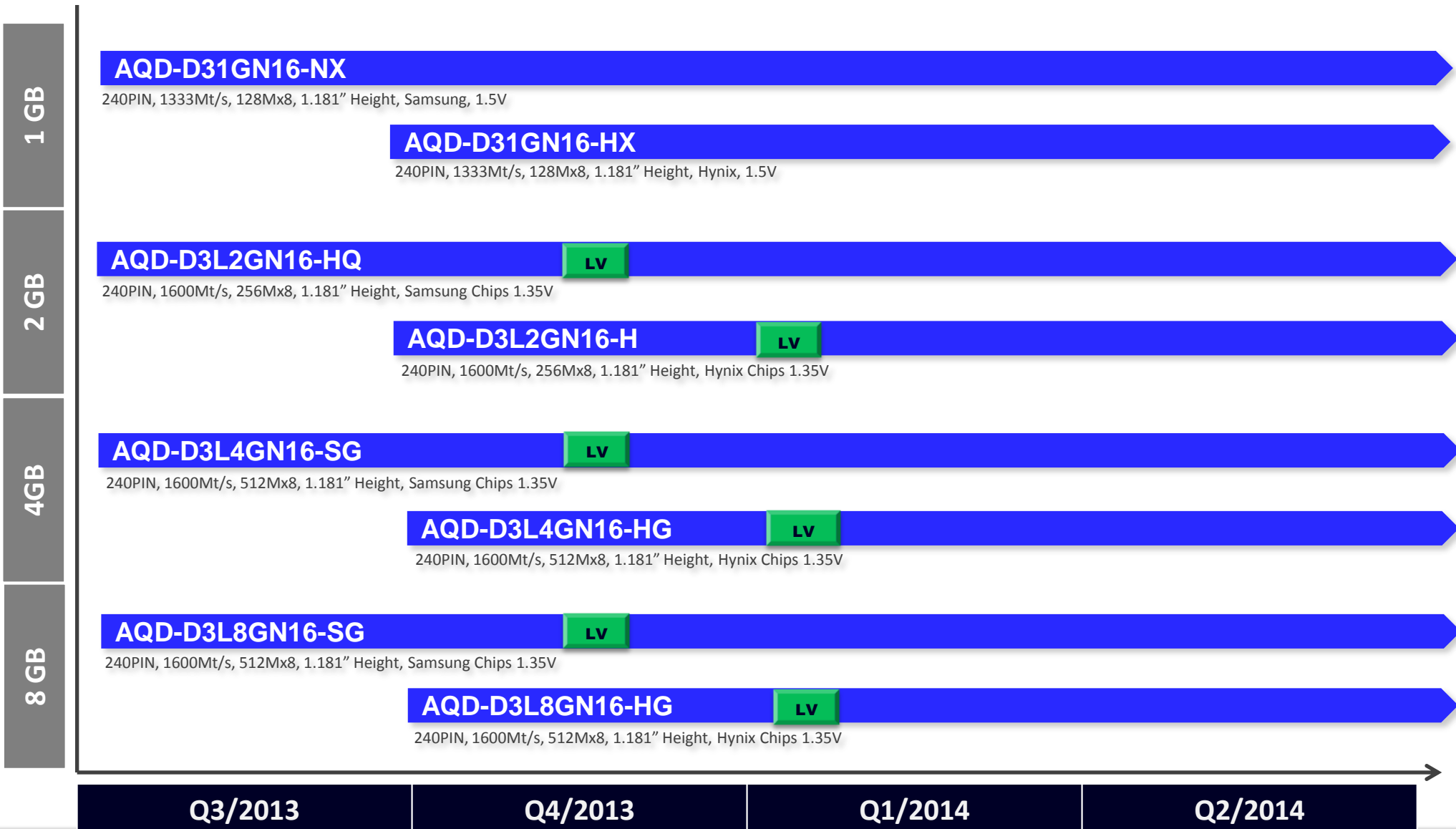

# DDR3 SO-DIMM

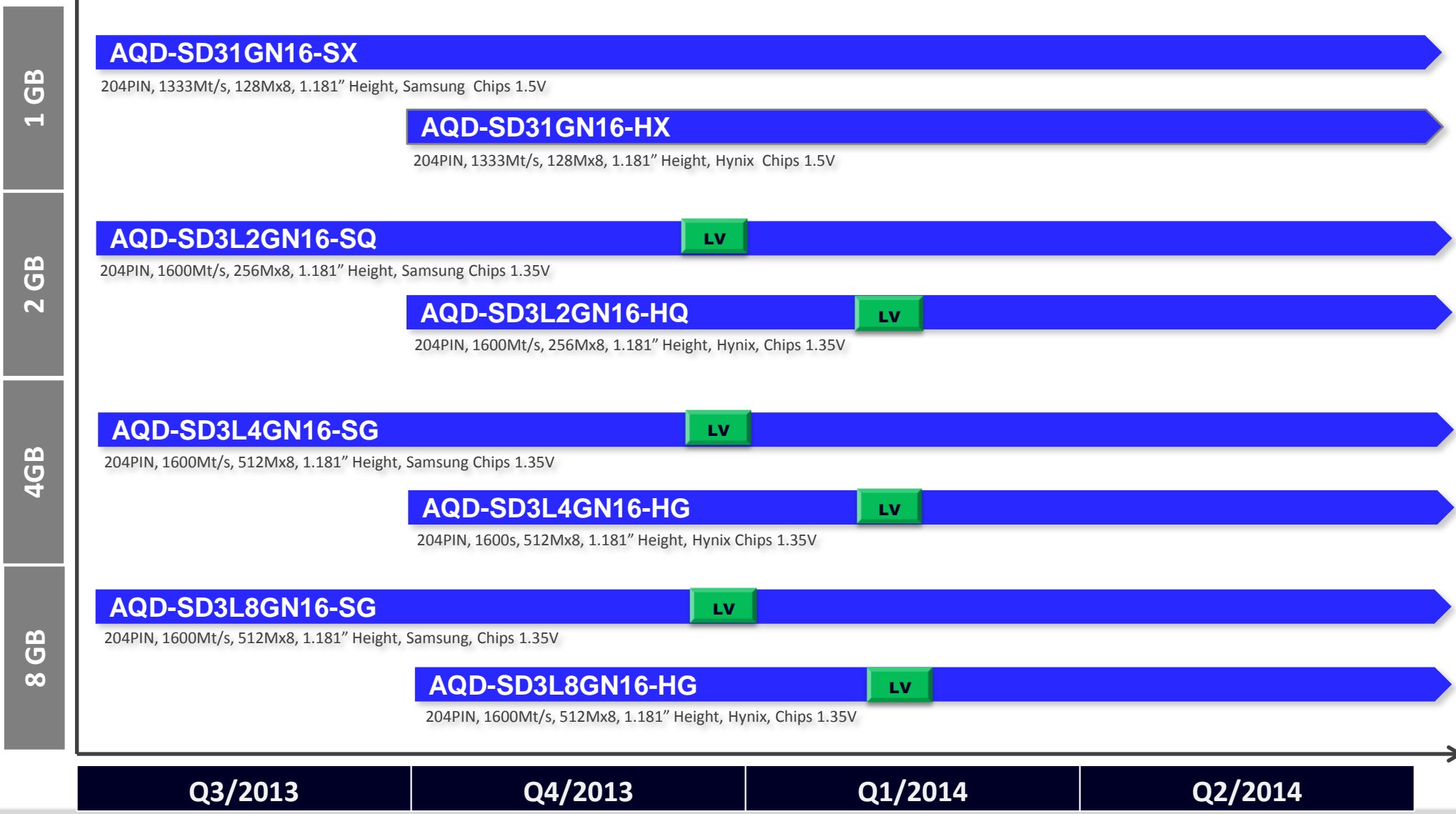

Q3/2013

Q4/2013

Q1/2014

Q2/2014

# DDR3 DIMM Advance Feature

## ECC

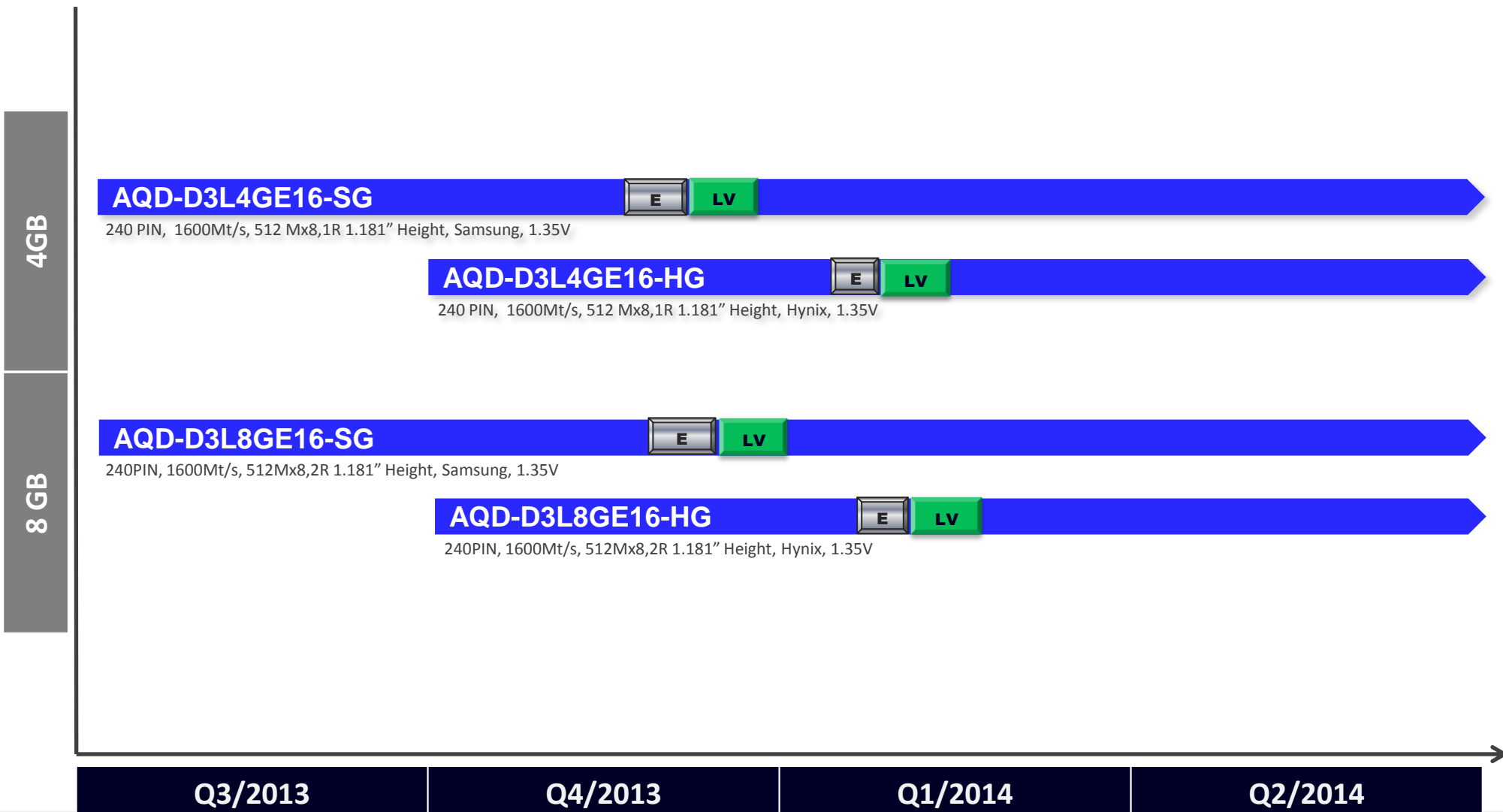



# DDR3 SO DIMM Advance Feature

## ECC

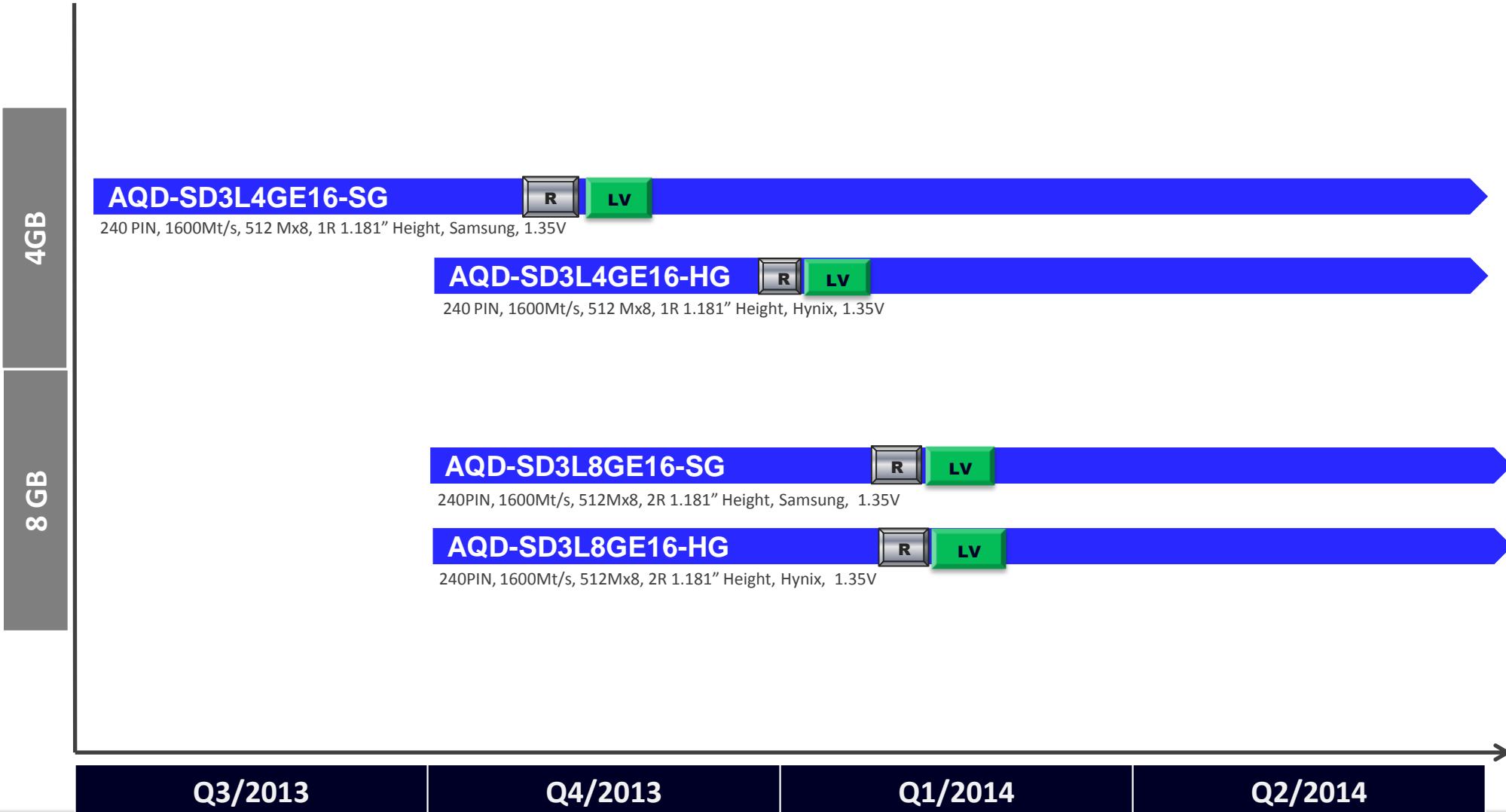

# DDR3 DIMM Advance Feature

## ECC and Registered

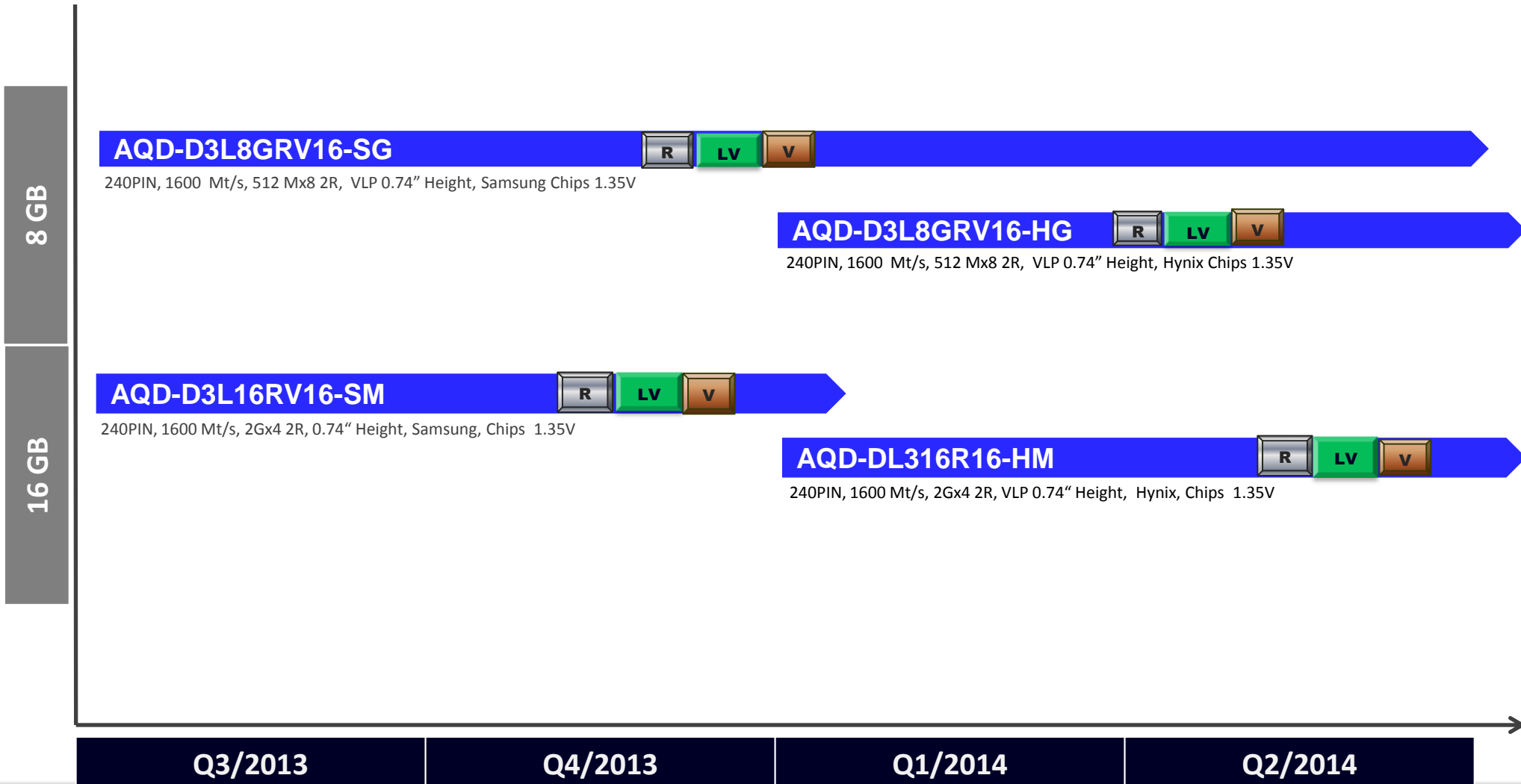

■ Available   
 ■ Phasing-out   
 ■ Planning

E ECC   
 R Registered   
 F Fully Buffered   
 N New

LR Load-Reduce   
 V Very Low-Profile   
 W Wide Temperature   
 LV Low-Voltage

# DDR3 DIMM Advance Feature

## Load Reduce

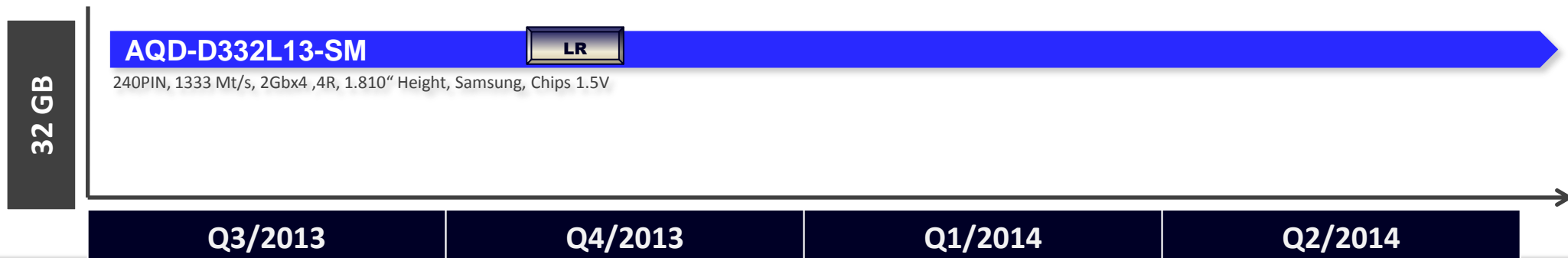

AQR-D332L13-SM

LR

240PIN, 1333 Mt/s, 2Gbx4 ,4R, 1.810" Height, Samsung, Chips 1.5V

32 GB

Q3/2013

Q4/2013

Q1/2014

Q2/2014

# PART II, 96 PARTS MEMORY MODULE

# Part Number Decoder

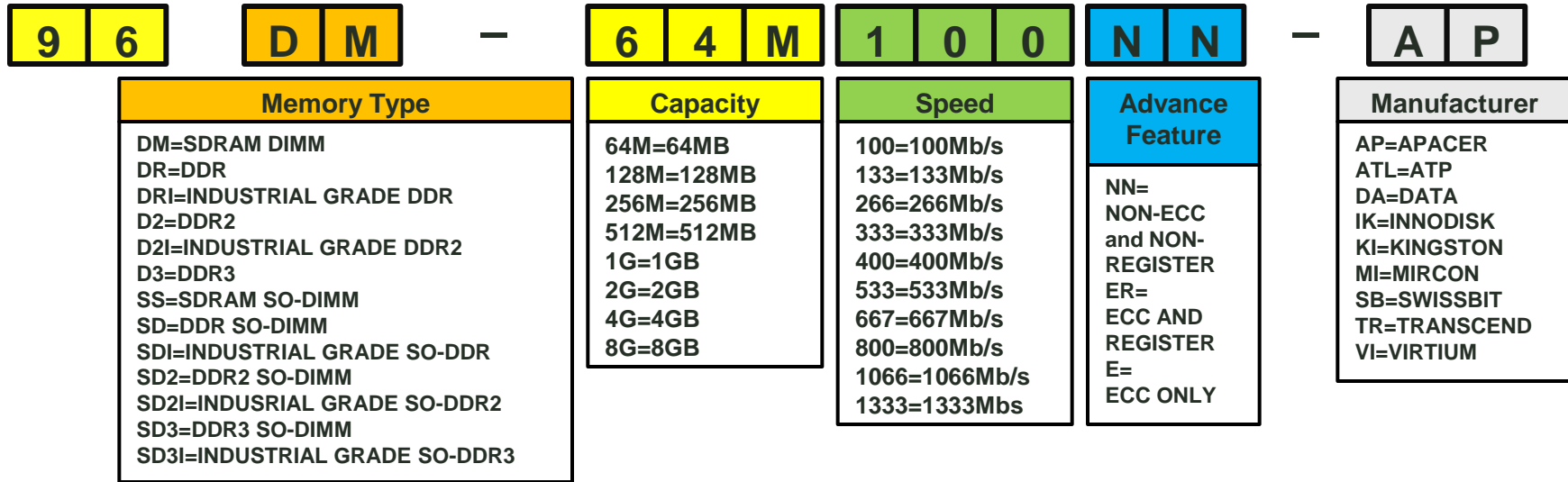

## Color / Symbol Key

Available
  Phasing-out
  Planning

E ECC
 R Registered
 F Fully Buffered
 ★ New

L Low-Profile
 V Very Low-Profile
 W Wide Temperature

# SDRAM DIMM

Available    Phasing-out    Planning

E ECC   
 R Registered   
 F Fully Buffered   
 N New  
L Low-Profile   
 V Very Low-Profile   
 W Wide Temperature

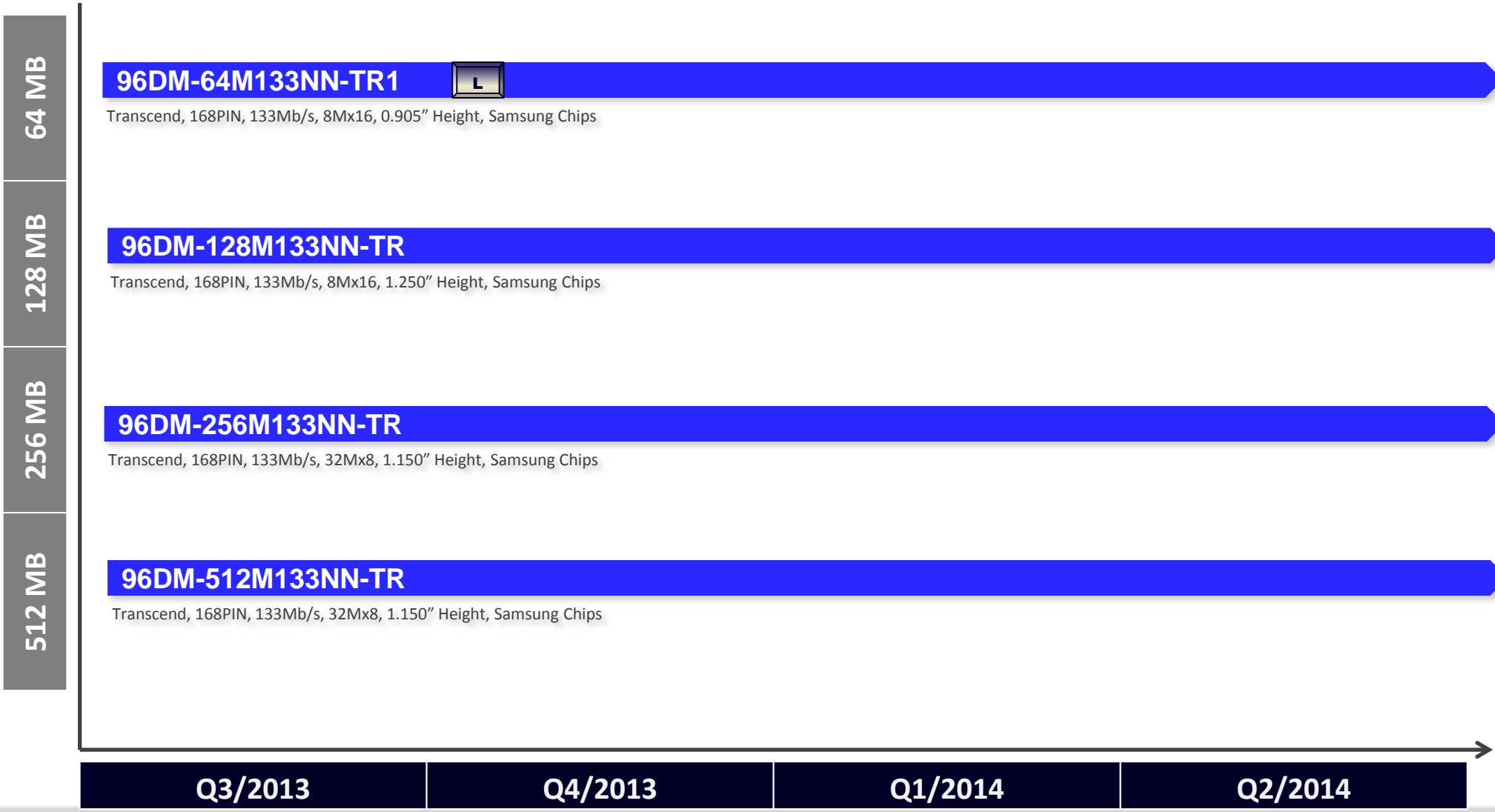

**96DM-64M133NN-TR1**  
 Transcend, 168PIN, 133Mb/s, 8Mx16, 0.905" Height, Samsung Chips

**96DM-128M133NN-TR**  
 Transcend, 168PIN, 133Mb/s, 8Mx16, 1.250" Height, Samsung Chips

**96DM-256M133NN-TR**  
 Transcend, 168PIN, 133Mb/s, 32Mx8, 1.150" Height, Samsung Chips

**96DM-512M133NN-TR**  
 Transcend, 168PIN, 133Mb/s, 32Mx8, 1.150" Height, Samsung Chips

Q3/2013

Q4/2013

Q1/2014

Q2/2014

# SDRAM SO-DIMM

Available Phasing-out Planning

E ECC   
 R Registered   
 F Fully Buffered   
 N New  
L Low-Profile   
 V Very Low-Profile   
 W Wide Temperature

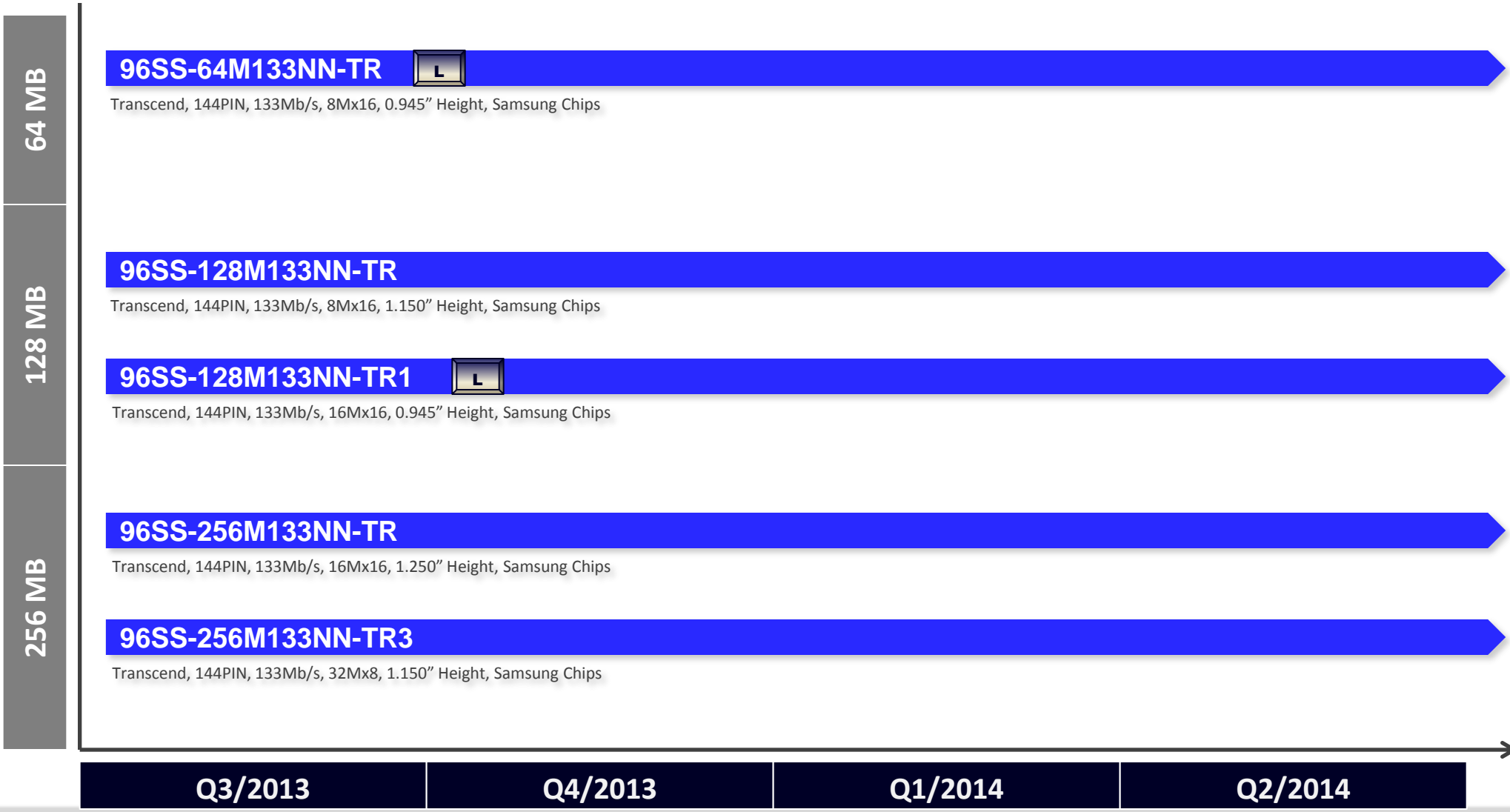



# DDR DIMM





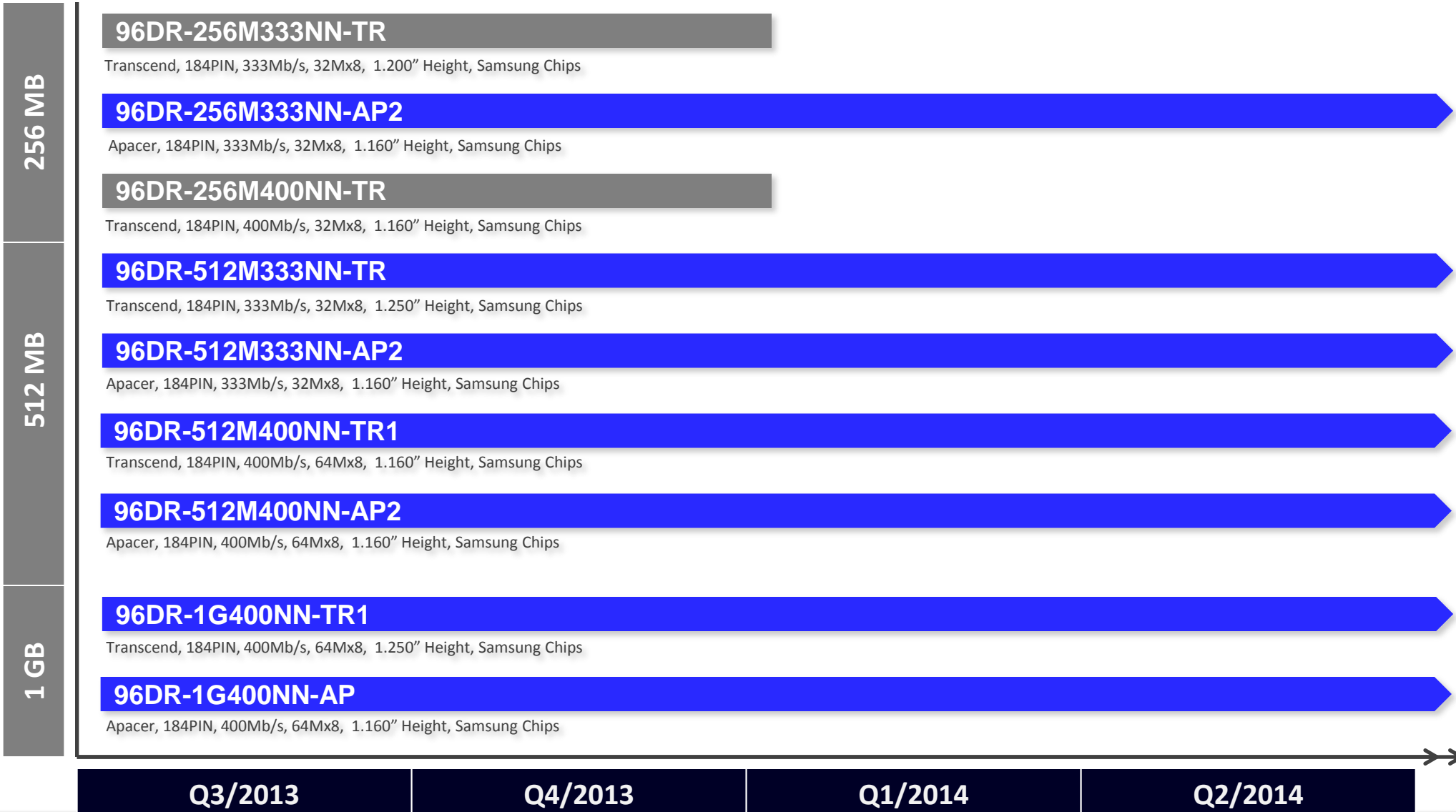

Available    Phasing-out    Planning

E ECC   
 R Registered   
 F Fully Buffered   
 N New  
L Low-Profile   
 V Very Low-Profile   
 W Wide Temperature



# DDR DIMM Advance Feature

Available Phasing-out Planning

-  ECC
-  Registered
-  Fully Buffered
-  New
-  Low-Profile
-  Very Low-Profile
-  Wide Temperature

## ECC

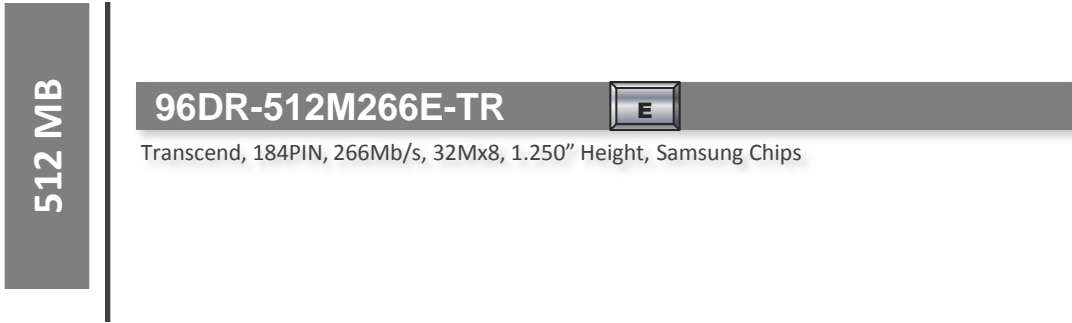

## ECC and Registered

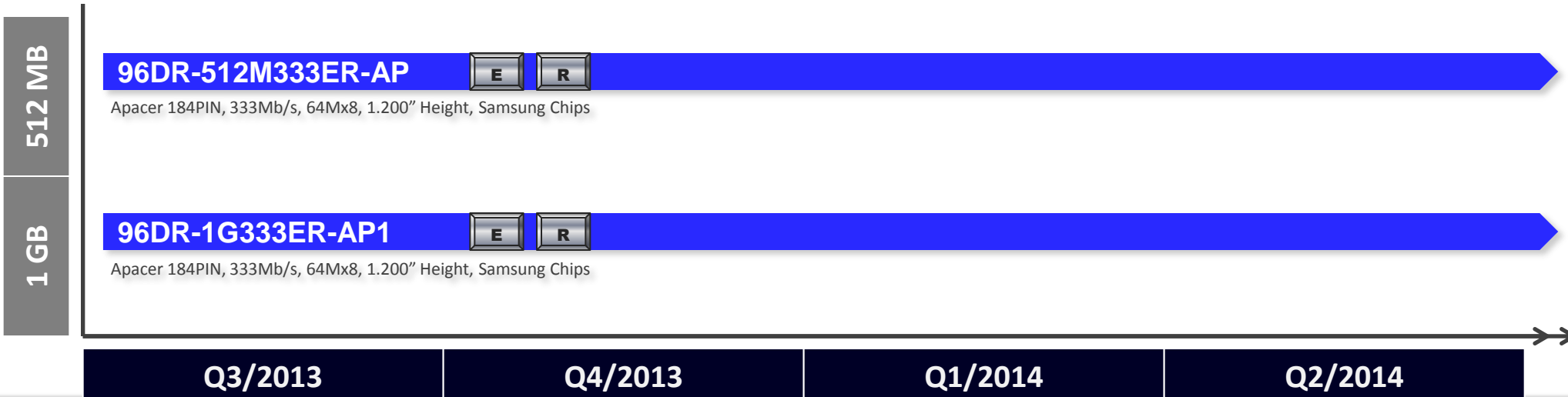

# DDR SO-DIMM

Available Phasing-out Planning

E ECC   
 R Registered   
 F Fully Buffered   
 N New  
L Low-Profile   
 V Very Low-Profile   
 W Wide Temperature

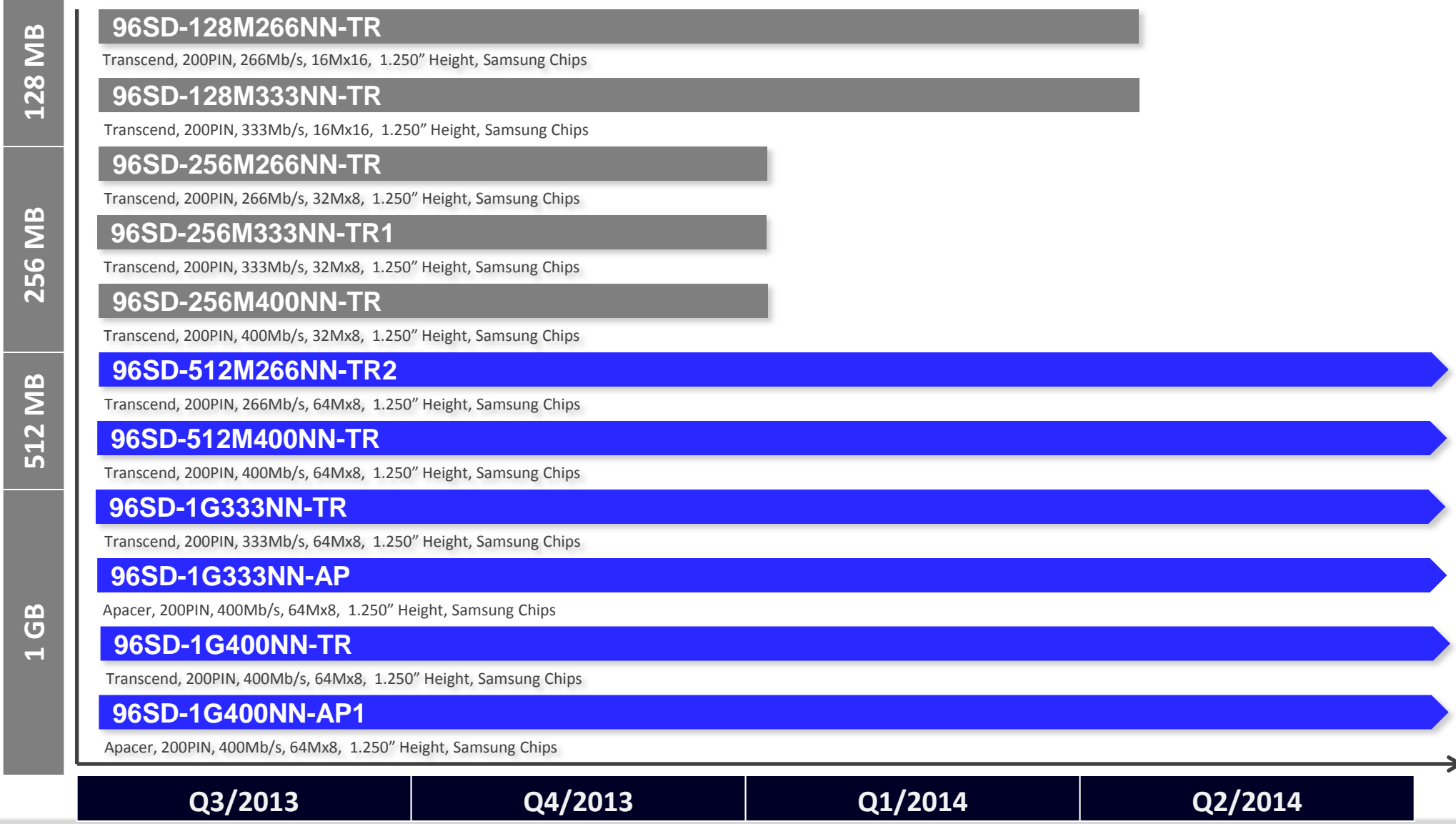

# DDR2 DIMM

Available Phasing-out Planning

ECC
 Registered
 Fully Buffered
 New
 Low-Profile
 Very Low-Profile
 Wide Temperature

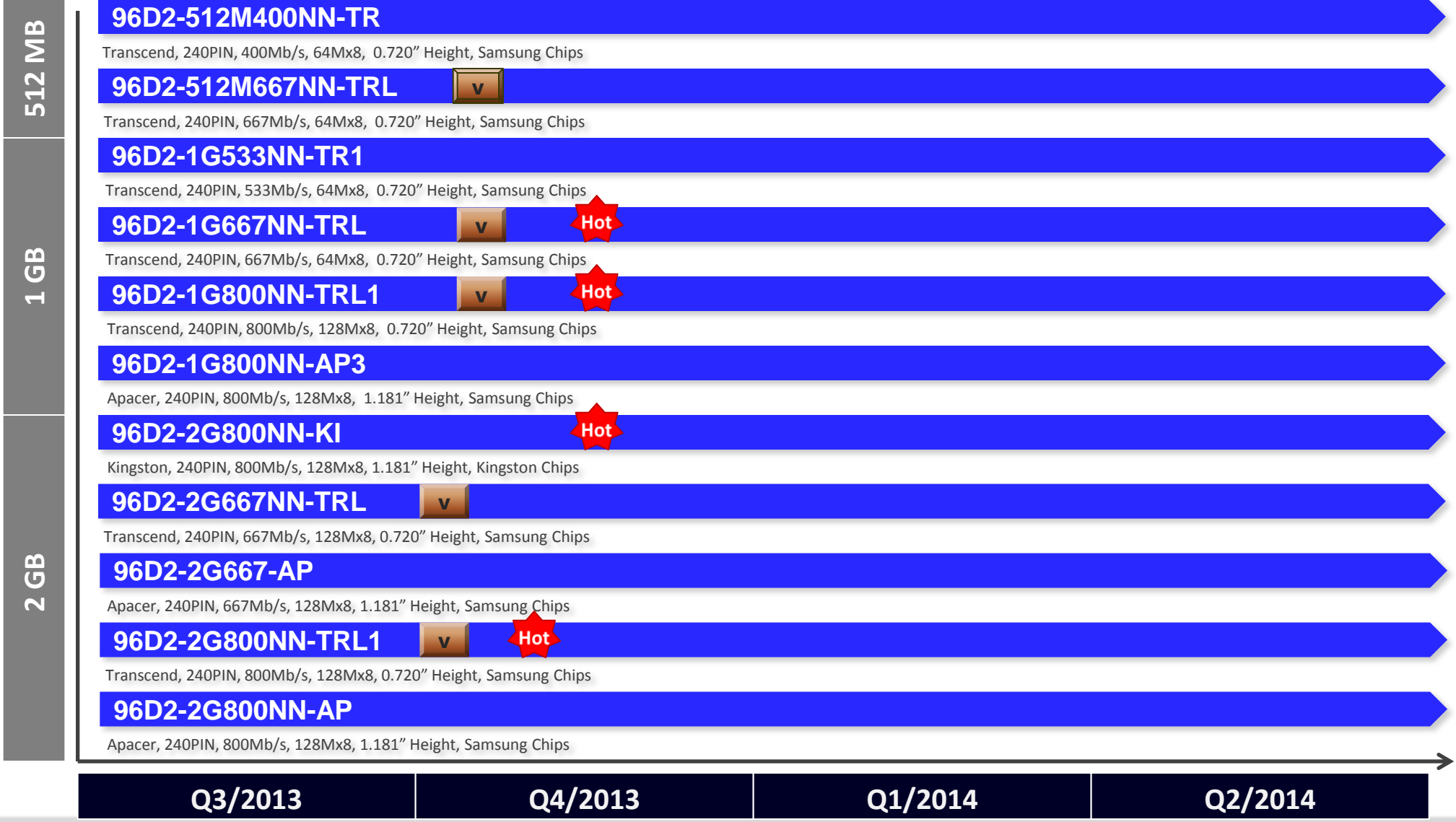

Q3/2013

Q4/2013

Q1/2014

Q2/2014

# DDR2 DIMM Advance Feature

Available    Phasing-out    Planning

E ECC   
 R Registered   
 F Fully Buffered   
 N New  
L Low-Profile   
 V Very Low-Profile   
 W Wide Temperature

## ECC



## ECC and Registered



Q3/2013

Q4/2013

Q1/2014

Q2/2014

# DDR2 DIMM Advance Feature

Available    Phasing-out    Planning

**E** ECC    **R** Registered    **F** Fully Buffered    **N** New

**L** Low-Profile    **V** Very Low-Profile    **W** Wide Temperature

## Fully Buffered

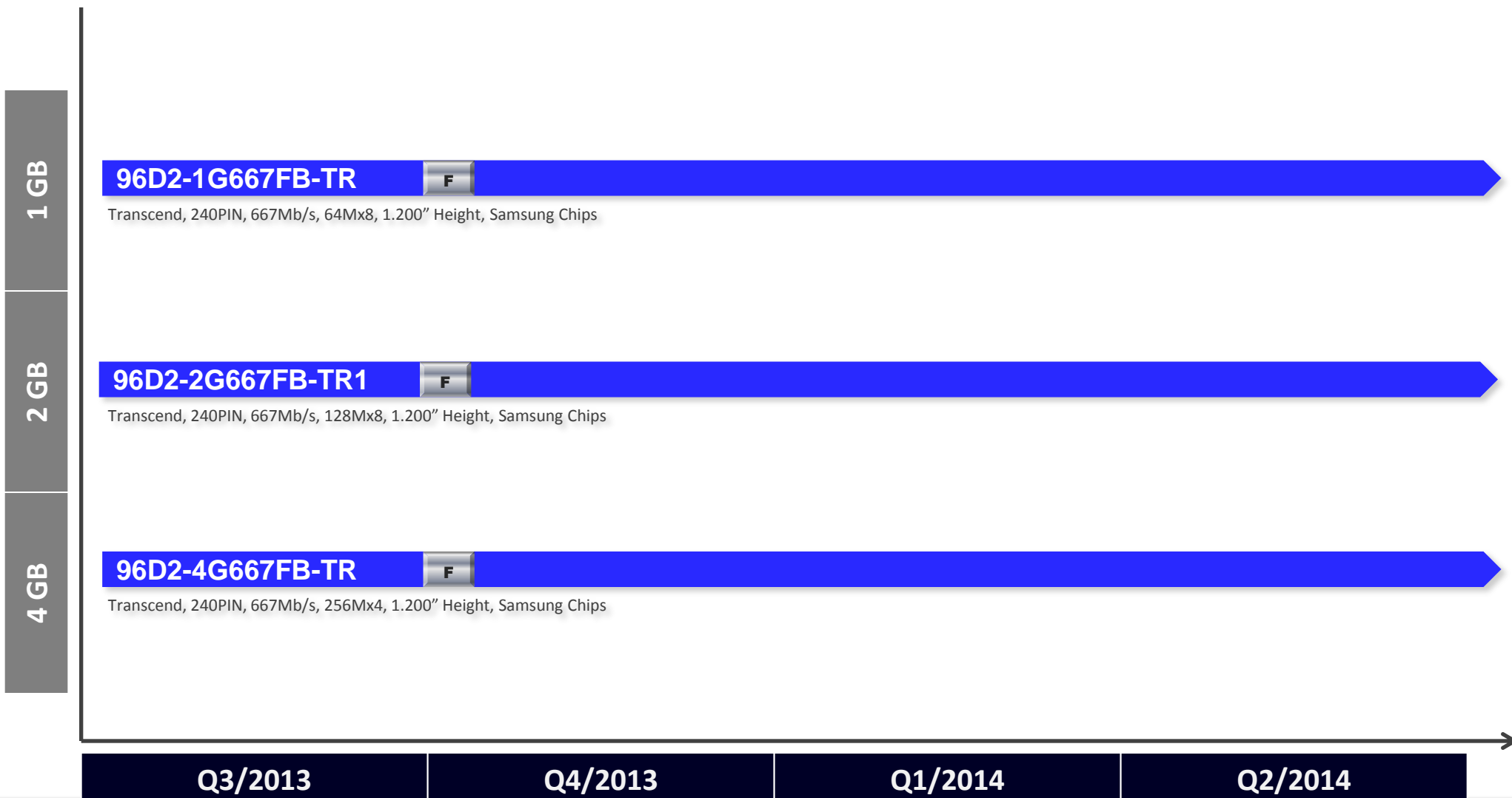

# DDR2 SO-DIMM

Available Phasing-out Planning

ECC
 Registered
 Fully Buffered
 New
 Low-Profile
 Very Low-Profile
 Wide Temperature

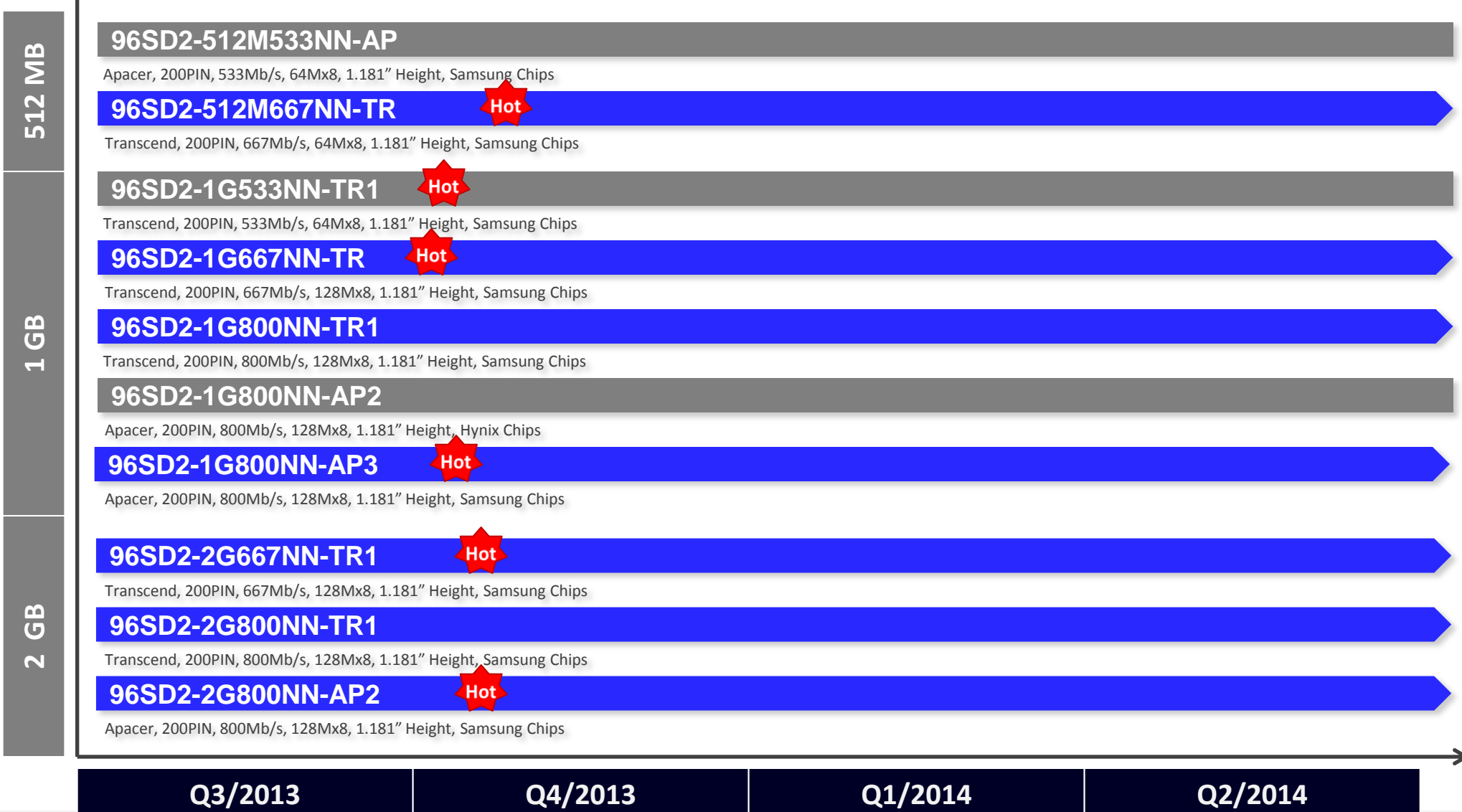

Q3/2013

Q4/2013

Q1/2014

Q2/2014



# DDR2 SO-DIMM Wide Temp.





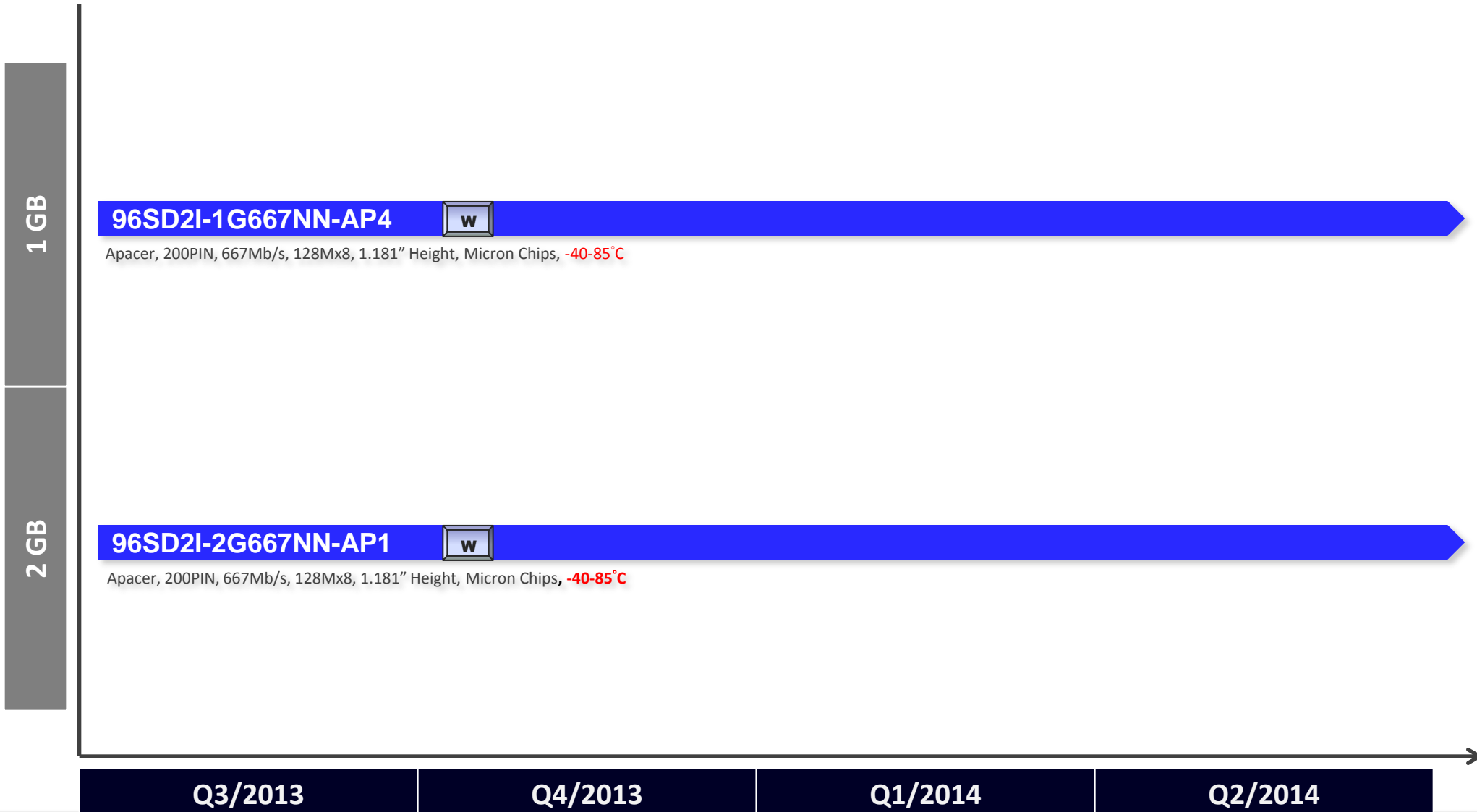

Available Phasing-out Planning

**E** ECC **R** Registered **F** Fully Buffered **N** New  
**L** Low-Profile **V** Very Low-Profile **W** Wide Temperature



# DDR3 DIMM

Available Phasing-out Planning

 ECC
  Registered
  Fully Buffered
  New  
 Low-Profile
  Very Low-Profile
  Wide Temperature

1 GB

## 96D3-1G1333NN-TR1

Transcend, 240PIN, 1333Mb/s, 128Mx8, 1.181" Height, Samsung Chips

## 96D3-1G1333NN-AP1

Apacer, 240PIN, 1333Mb/s, 128Mx8, 1.181" Height, Hynix Chips

## 96D3-2G1066NN-TR

Transcend, 240PIN, 1066Mb/s, 128Mx8, 1.181" Height, Samsung Chips **EOL:7/9/13**

## 96D3-2G1333NN-TR2

Transcend, 240PIN, 1333Mb/s, 128Mx8, 1.181" Height, Samsung Chips

## 96D3-2G1333NN-AP4

Apacer, 240PIN, 1333Mb/s, 128Mx8, 1.181" Height, Hynix Chips

## 96D3-2G1333NN-TR1

Transcend, 240PIN, 1333Mb/s, 256Mx8, 1.181" Height, Hynix Chips

## 96D3-2G1333NN-AP1

Apacer, 240PIN, 1333Mb/s, 256Mx8, 1.181" Height, Hynix Chips

## 96D3-2G1600NN-APL

Apacer, 240PIN, 1600Mb/s, 256Mx8, 0.740" Height, Hynix Chips

## 96D3-2G1600NN-TR

Transcend, 240PIN, 1600Mb/s, 256Mx8, 1.181" Height, MICRON Chips

## 96D3-2G1600NN-TRL

Transcend, 240PIN, 1600Mb/s, 256Mx8, 0.74" Height, Samsung Chips

2 GB

Q3/2013

Q4/2013

Q1/2014

Q2/2014

# DDR3 DIMM

Available    Phasing-out    Planning

ECC   
 Registered   
 Fully Buffered   
 New  
 Low-Profile   
 Very Low-Profile   
 Wide Temperature

4 GB

**96D3-4G1333NN-TR**

Transcend, 240PIN, 1333Mb/s, 256Mx8, 1.181" Height, Hynix Chips

**96D3-4G1333NN-AP**

Apacer, 240PIN, 1333Mb/s, 256Mx8, 1.181" Height, Hynix Chips

**96D3-4G1600NN-APL**

Apacer, 240PIN, 1600Mb/s, 256Mx8, 0.740" Height, Hynix Chips

96D3-4G1600NN-TR

Transcend, 240PIN, 1600Mb/s, 256Mx8, 1.181" Height, Micron Chips **EOL:7/9/2013**

**96D3-4G1600NN-TR**

Transcend, 240PIN, 1600Mb/s, 256Mx8, 1.181" Height, Samsung Chips

8 GB

**96D3-8G1333NN-APL**

Apacer, 240PIN, 1333Mb/s, 512Mx8, 0.740" Height, Micron Chips

**96D3-8G1600NN-APL**

Apacer, 240PIN, 1600Mb/s, 512Mx8, 0.740" Height, Micron Chips

**96D3-8G1600NN-TR**

Transcend, 240PIN, 1600Mb/s, 512Mx8, 1.181" Height, Micron Chips

Q3/2013

Q4/2013

Q1/2014

Q2/2014

# DDR3 DIMM Advance Feature

Available Phasing-out Planning

E ECC   
 R Registered   
 F Fully Buffered   
 N New  
L Low-Profile   
 V Very Low-Profile   
 W Wide Temperature

## ECC

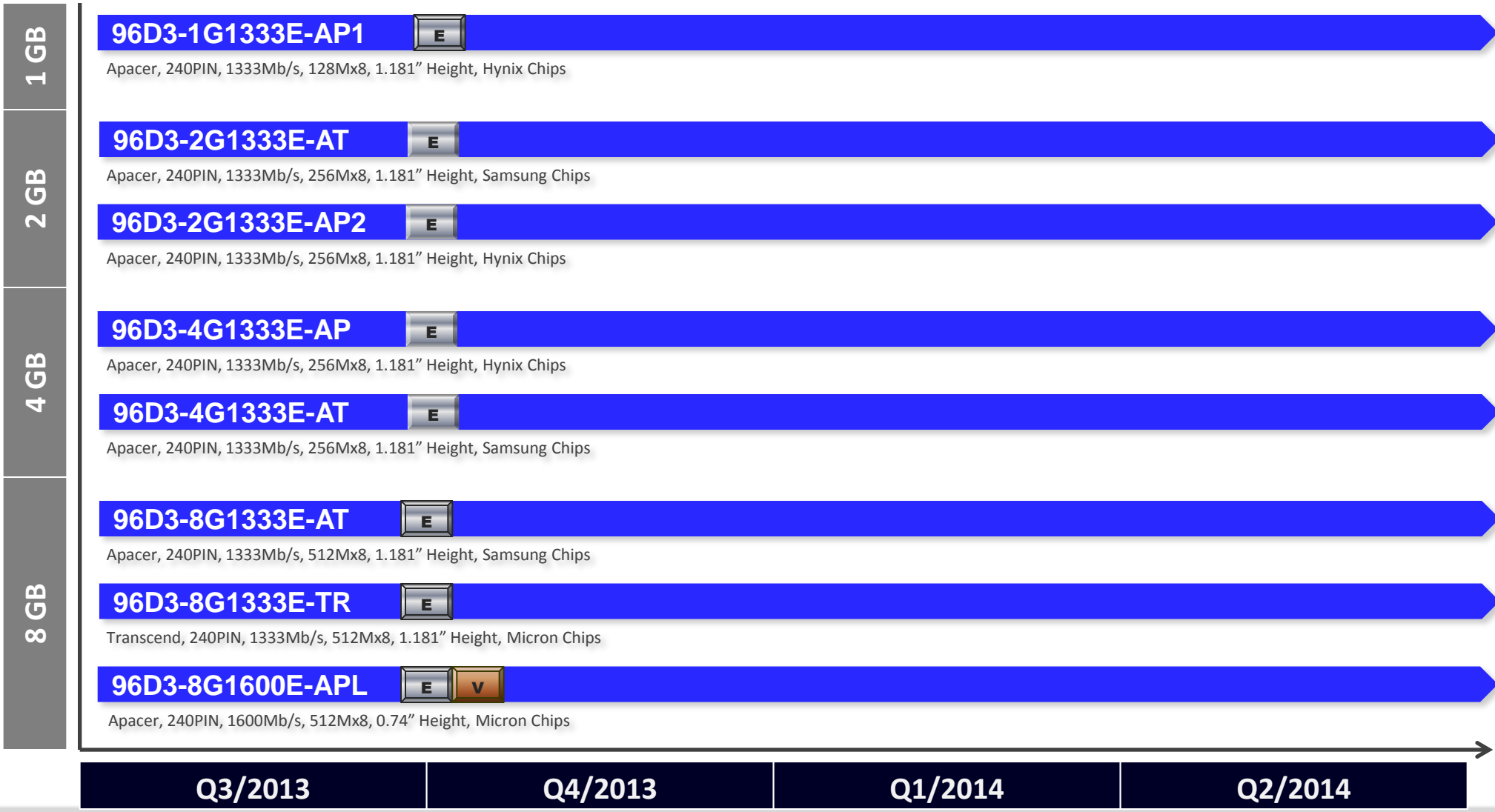

Q3/2013

Q4/2013

Q1/2014

Q2/2014

# DDR3 DIMM Advance Feature

Available Phasing-out Planning

E ECC   
 R Registered   
 F Fully Buffered   
 N New  
L Low-Profile   
 V Very Low-Profile   
 W Wide Temperature

## ECC and Registered

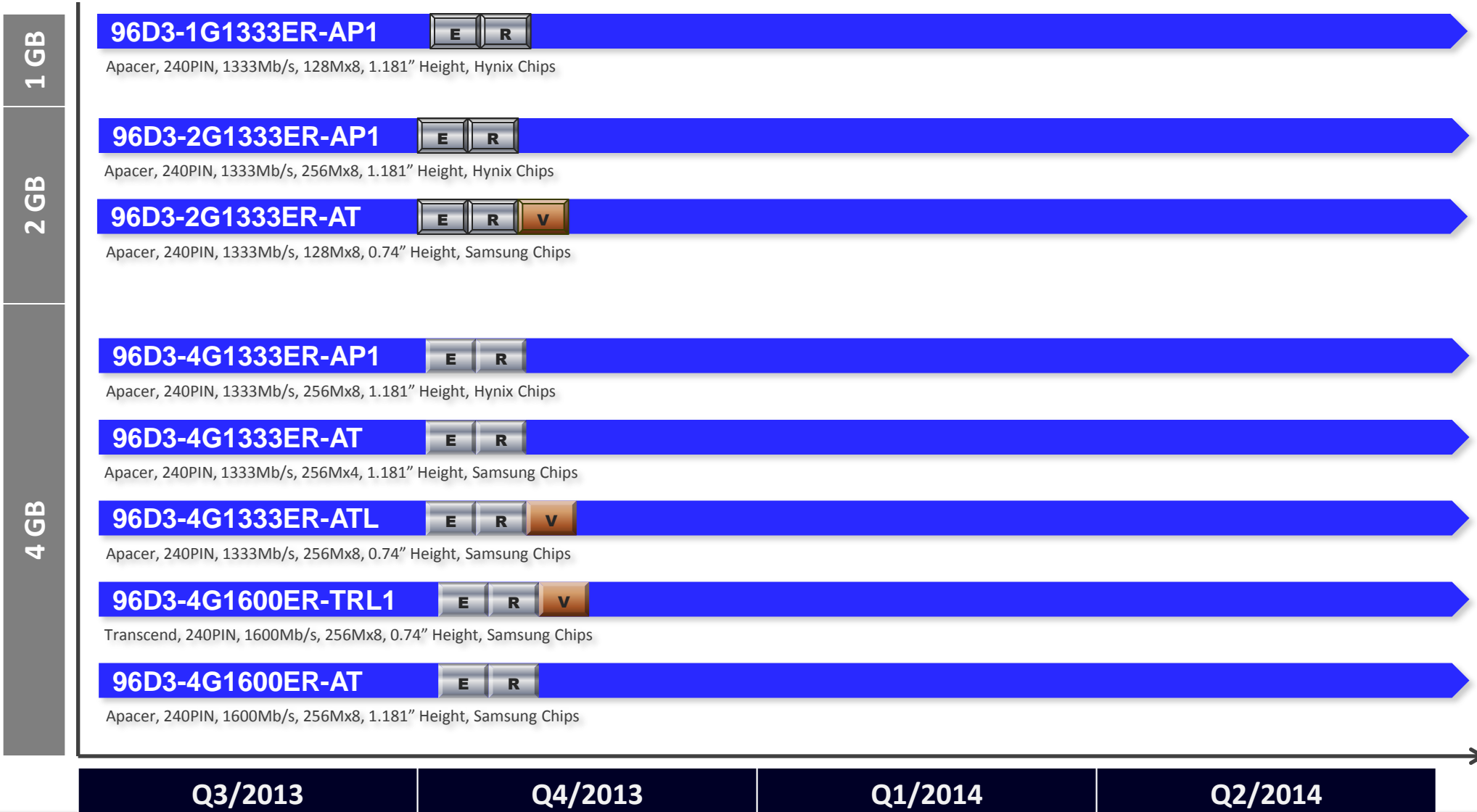

# DDR3 DIMM Advance Feature

Available Phasing-out Planning

E ECC R Registered F Fully Buffered N New  
L Low-Profile V Very Low-Profile W Wide Temperature

## ECC and Registered

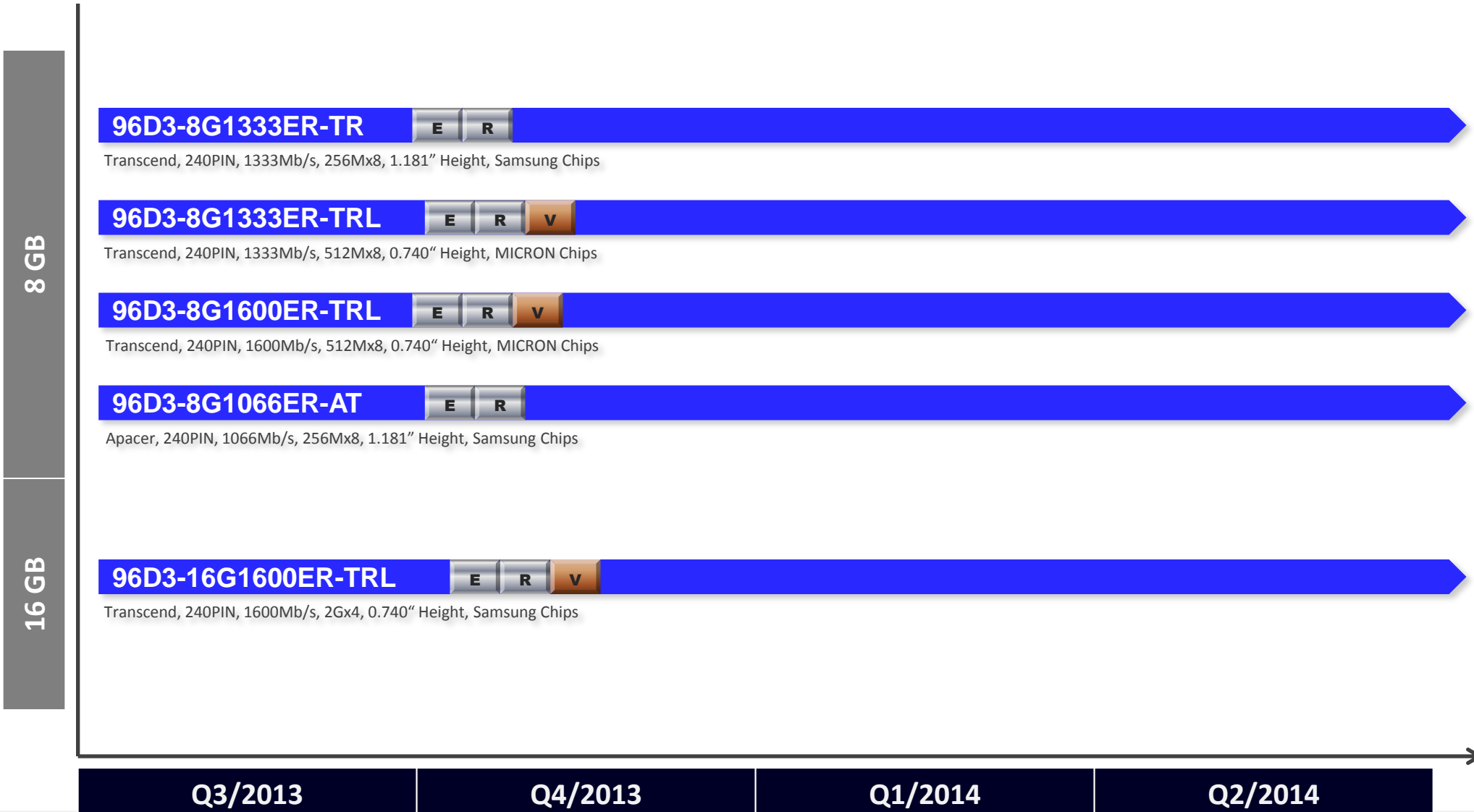

Q3/2013

Q4/2013

Q1/2014

Q2/2014

# DDR3 SO-DIMM

Available    Phasing-out    Planning

E ECC    R Registered    F Fully Buffered    N New  
L Low-Profile    V Very Low-Profile    W Wide Temperature

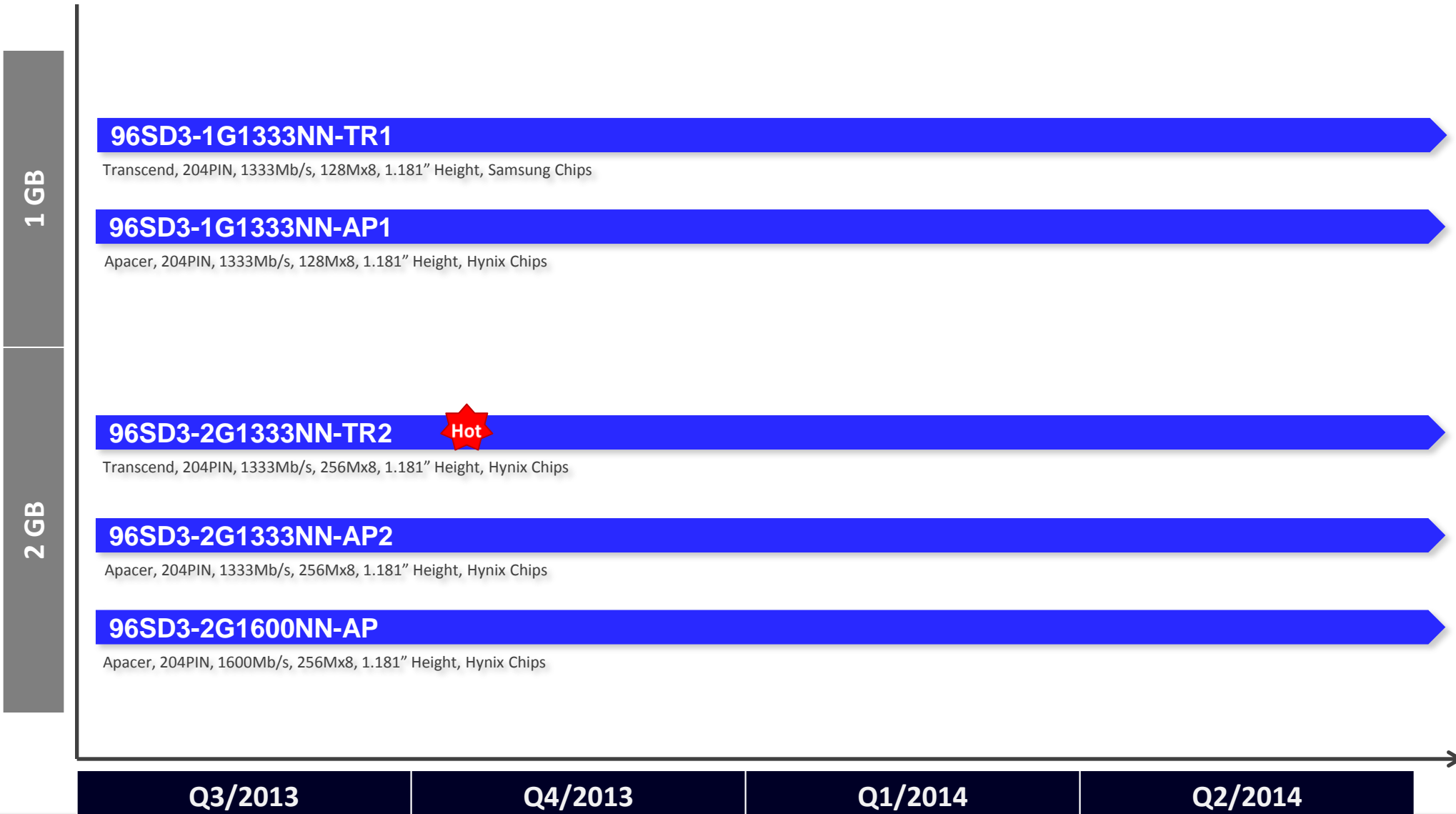

Q3/2013

Q4/2013

Q1/2014

Q2/2014



# DDR3 SO-DIMM

Available Phasing-out Planning

E ECC   
 R Registered   
 F Fully Buffered   
 N New  
L Low-Profile   
 V Very Low-Profile   
 W Wide Temperature

4 GB

## 96SD3-4G1066NN-AP

Apacer, 204PIN, 1066Mb/s, 256Mx8, 1.181" Height, Hynix Chips

## 96SD3-4G1333NN-TR1

Transcend, 204PIN, 1333Mb/s, 256Mx8, 1.181" Height, Hynix Chips

## 96SD3-4G1333NN-AP1

Apacer, 204PIN, 1333Mb/s, 256Mx8, 1.181" Height, Hynix Chips

## 96SD3-4G1600NN-TR

Transcend, 204PIN, 1600Mb/s, 256Mx8, 1.181" Height, Micron Chips

## 96SD3-4G1600NN-AP

Apacer, 204PIN, 1600Mb/s, 256Mx8, 1.181" Height, Hynix Chips

8 GB

## 96SD3-8G1333NN-TR

Transcend, 204PIN, 1333Mb/s, 512Mx8, 1.181" Height, Micron Chips

## 96SD3-8G1600NN-TR

Transcend, 204PIN, 1600Mb/s, 512Mx8, 1.181" Height, Micron Chips

## 96SD3-8G1600NN-AP

Apacer, 204PIN, 1600Mb/s, 512Mx8, 1.181" Height, HYNIX Chips

## 96SD3-8G1600NN-AT

Apacer, 204PIN, 1600Mb/s, 512Mx8, 1.181" Height, Samsung Chips

Q3/2013

Q4/2013

Q1/2014

Q2/2014

# DDR3 SO-DIMM

## Advance Feature - ECC

Available    Phasing-out    Planning

**E** ECC    **R** Registered    **F** Fully Buffered    **N** New  
**L** Low-Profile    **V** Very Low-Profile    **W** Wide Temperature

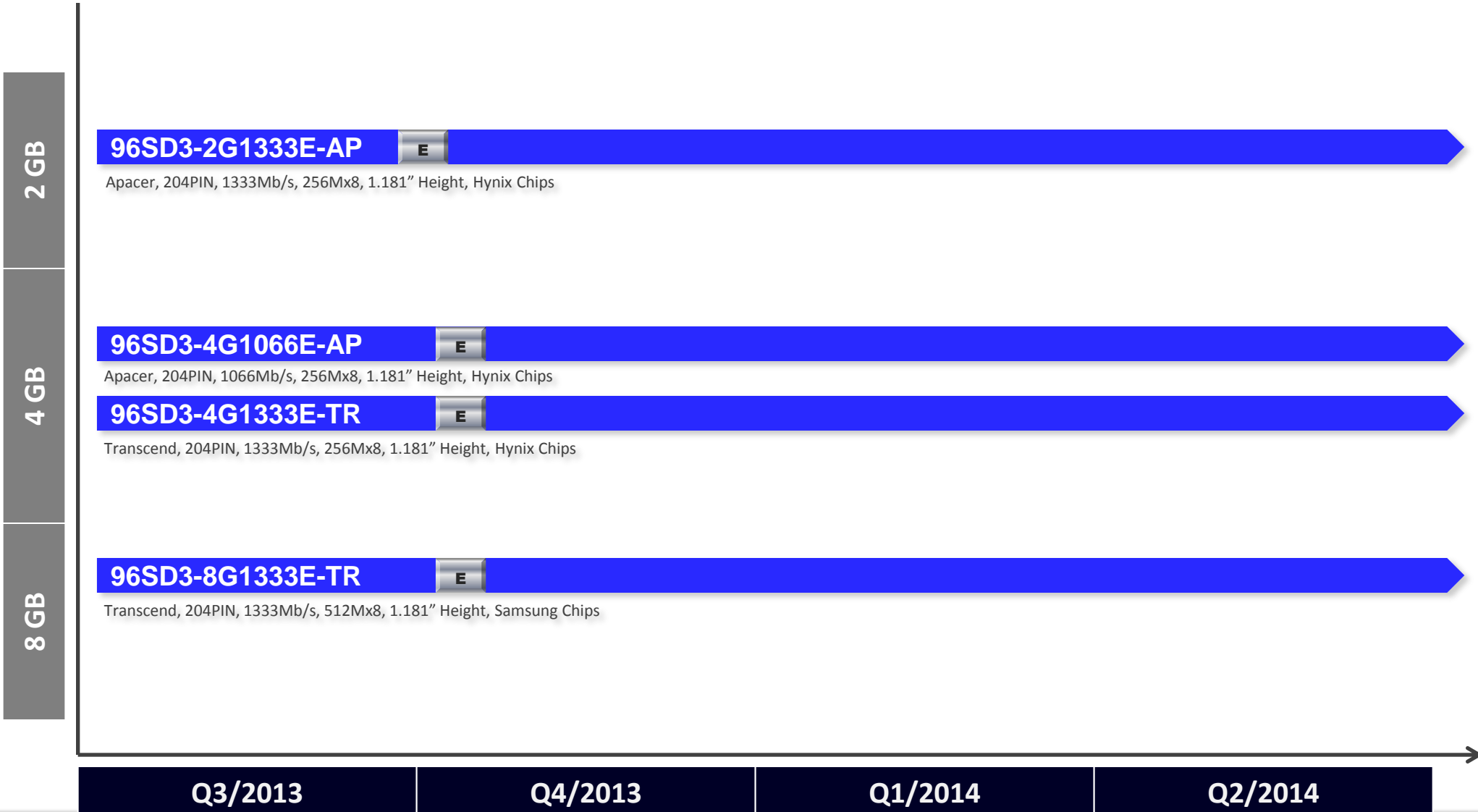

# DDR3 SO-DIMM

## Low Voltage.

Available Phasing-out Planning

**E** ECC **R** Registered **F** Fully Buffered **N** New  
**L** Low-Profile **V** Very Low-Profile **W** Wide Temperature

2 GB

96SD3L-2G1600NN-TR

Transcend, 204PIN, 1600Mb/s, 256Mx8, 1.35V, 1.181" Height, Samsung Chips EOL:7/9/2013

4 GB

96SD3L-4G1333NN-AP

Apacer, 204PIN, 1333Mb/s, 512Mx8, 1.35V, 1.181" Height, MICRO Chips

96SD3L-4G1600NN-TR

Transcend, 204PIN, 1600Mb/s, 512Mx8, 1.35V, 1.181" Height, SAMSUNG Chips EOL:7/9/2013

8 GB

96SD3L-8G1333NN-AP

Apacer, 204PIN, 1333Mb/s, 512Mx8, 1.35V, 1.181" Height, MICRO Chips

96SD3L-8G1600NN-TR

Transcend, 204PIN, 1600Mb/s, 512Mx8, 1.35V, 1.181" Height, SAMSUNG Chips EOL:7/9/2013

Q3/2013

Q4/2013

Q1/2014

Q2/2014

# Memory EOL Procedure

- For support and product management optimization, PAPS will follow the Memory phase-out procedure as below.



*Thank you*





**Стандарт  
Электрон  
Связь**

Мы молодая и активно развивающаяся компания в области поставок электронных компонентов. Мы поставляем электронные компоненты отечественного и импортного производства напрямую от производителей и с крупнейших складов мира.

Благодаря сотрудничеству с мировыми поставщиками мы осуществляем комплексные и плановые поставки широчайшего спектра электронных компонентов.

Собственная эффективная логистика и склад в обеспечивает надежную поставку продукции в точно указанные сроки по всей России.

Мы осуществляем техническую поддержку нашим клиентам и предпродажную проверку качества продукции. На все поставляемые продукты мы предоставляем гарантию .

Осуществляем поставки продукции под контролем ВП МО РФ на предприятия военно-промышленного комплекса России , а также работаем в рамках 275 ФЗ с открытием отдельных счетов в уполномоченном банке. Система менеджмента качества компании соответствует требованиям ГОСТ ISO 9001.

Минимальные сроки поставки, гибкие цены, неограниченный ассортимент и индивидуальный подход к клиентам являются основой для выстраивания долгосрочного и эффективного сотрудничества с предприятиями радиоэлектронной промышленности, предприятиями ВПК и научно-исследовательскими институтами России.

С нами вы становитесь еще успешнее!

**Наши контакты:**

**Телефон:** +7 812 627 14 35

**Электронная почта:** [sales@st-electron.ru](mailto:sales@st-electron.ru)

**Адрес:** 198099, Санкт-Петербург,  
Промышленная ул, дом № 19, литера Н,  
помещение 100-Н Офис 331