

FEATURES

- **Low-Voltage Operation . . . Down to 1.24 V**
- **Reference Voltage Tolerances at 25°C**
 - 0.5% for B Grade
 - 1% for A Grade
 - 1.5% for Standard Grade
- **Adjustable Output Voltage, $V_O = V_{REF}$ to 18 V**
- **Wide Operating Cathode Current Range . . . 55 μ A to 80 mA**
- **0.25- Ω Typical Output Impedance**
- **–40°C to 125°C Specifications**
- **TLVH432 Provides Alternative Pinouts for SOT-23-3 and SOT-89 Packages**
- **Ultra-Small SC-70 Package Offers 40% Smaller Footprint Than SOT-23-3**

**TLVH431
DBV (SOT-23-5) PACKAGE
(TOP VIEW)**

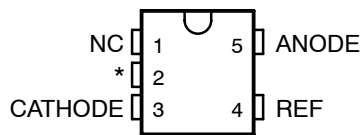

NC – No internal connection

* Pin 2 is attached to Substrate and must be connected to ANODE or left open.

**TLVH431
DBZ (SOT-23-3) PACKAGE
(TOP VIEW)**

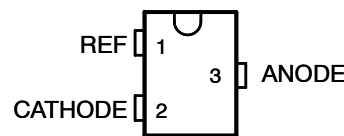

**TLVH431
DCK (SC-70) PACKAGE
(TOP VIEW)**

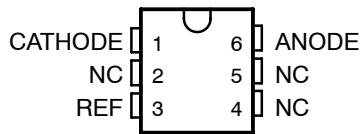

NC – No internal connection

**TLVH431
LP (TO-92/TO-226) PACKAGE
(TOP VIEW)**

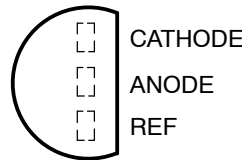

**TLVH431
PK (SOT-89) PACKAGE
(TOP VIEW)**

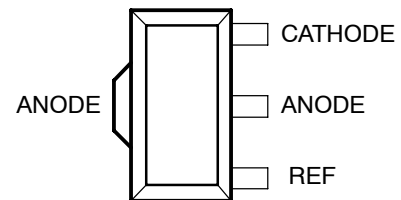

**TLVH432
PK (SOT-89) PACKAGE
(TOP VIEW)**

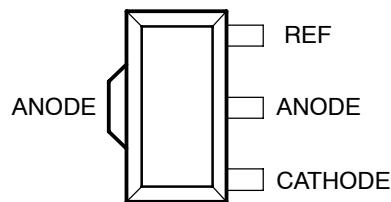

**TLVH432
DBZ (SOT-23-3) PACKAGE
(TOP VIEW)**

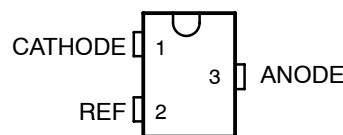

DESCRIPTION/ORDERING INFORMATION

The TLVH431 and TLVH432 are low-voltage 3-terminal adjustable voltage references, with specified thermal stability over applicable industrial and commercial temperature ranges. Output voltage can be set to any value between V_{REF} (1.24 V) and 18 V with two external resistors (see [Figure 2](#)). These devices operate from a lower voltage (1.24 V) than the widely used TL431 and TL1431 shunt-regulator references.



Please be aware that an important notice concerning availability, standard warranty, and use in critical applications of Texas Instruments semiconductor products and disclaimers thereto appears at the end of this data sheet.

**TLVH431, TLVH431A, TLVH431B
TLVH432, TLVH432A, TLVH432B
LOW-VOLTAGE ADJUSTABLE PRECISION SHUNT REGULATORS**

SLVS555G–NOVEMBER 2004–REVISED JANUARY 2006

DESCRIPTION/ORDERING INFORMATION (CONTINUED)

When used with an optocoupler, the TLVH431 and TLVH432 are ideal voltage references in isolated feedback circuits for 3-V to 3.3-V switching-mode power supplies. They have a typical output impedance of 0.25 Ω . Active output circuitry provides a very sharp turn-on characteristic, making the TLVH431 and TLVH432 excellent replacements for low-voltage Zener diodes in many applications, including on-board regulation and adjustable power supplies.

The TLVH432 is identical to the TLVH431, but is offered with different pinouts for the SOT-23-3 and SOT-89 packages.

ORDERING INFORMATION

T_A	V_{REF} TOLERANCE	PACKAGE ⁽¹⁾		ORDERABLE PART NUMBER	TOP-SIDE MARKING ⁽²⁾
0°C to 70°C	0.5%	SC-70 – DCK	Reel of 3000	TLVH431BCDCKR	YH_
			Reel of 250	TLVH431BCDCKT	
		SOT-23-5 – DBV	Reel of 3000	TLVH431BCDBVR	Y3J_
			Reel of 250	TLVH431BCDBVT	
		SOT-23-3 – DBZ	Reel of 3000	TLVH431BCDBZR	Y3J_
				TLVH432BCDBZR	Y2H_
			Reel of 250	TLVH431BCDBZT	Y3J_
				TLVH432BCDBZT	Y2H_
		SOT-89 – PK	Reel of 1000	TLVH431BCPK	V7
				TLVH432BCPK	VN
		TO-92 – LP	Bulk of 1000	TLVH431BCLP	ZA431B
			Reel of 2000	TLVH431BCLPR	
	1%	SC-70 – DCK	Reel of 3000	TLVH431ACDCKR	YP_
			Reel of 250	TLVH431ACDCKT	
		SOT-23-5 – DBV	Reel of 3000	TLVH431ACDBVR	Y3P_
			Reel of 250	TLVH431ACDBVT	
		SOT-23-3 – DBZ	Reel of 3000	TLVH431ACDBZR	Y3P_
				TLVH432ACDBZR	Y2E_
			Reel of 250	TLVH431ACDBZT	Y3P_
				TLVH432ACDBZT	Y2E_
		SOT-89 – PK	Reel of 1000	TLVH431ACPK	W2
				TLVH432ACPK	VK
		TO-92 – LP	Bulk of 1000	TLVH431ACL	ZA431A
			Reel of 2000	TLVH431ACLPR	
	1.5%	SC-70 – DCK	Reel of 3000	TLVH431CDCKR	YU_
			Reel of 250	TLVH431CDCKT	
		SOT-23-5 – DBV	Reel of 3000	TLVH431CDBVR	Y3U_
			Reel of 250	TLVH431CDBVT	
		SOT-23-3 – DBZ	Reel of 3000	TLVH431CDBZR	Y3U_
				TLVH432CDBZR	Y2A_
Reel of 250			TLVH431CDBZT	Y3U_	
			TLVH432CDBZT	Y2A_	
SOT-89 – PK		Reel of 1000	TLVH431CPK	W4	
			TLVH432CPK	VG	
TO-92 – LP		Bulk of 1000	TLVH431CLP	ZA431	
		Reel of 2000	TLVH431CLPR		

(1) Package drawings, standard packing quantities, thermal data, symbolization, and PCB design guidelines are available at www.ti.com/sc/package.

(2) DBV/DBZ/DCK: The actual top-side marking has one additional character that designates the assembly/test site.

TLVH431, TLVH431A, TLVH431B
 TLVH432, TLVH432A, TLVH432B
 LOW-VOLTAGE ADJUSTABLE PRECISION SHUNT REGULATORS



SLVS555G – NOVEMBER 2004 – REVISED JANUARY 2006

ORDERING INFORMATION (continued)

T_A	V_{REF} TOLERANCE	PACKAGE ⁽¹⁾	ORDERABLE PART NUMBER	TOP-SIDE MARKING ⁽²⁾	
-40°C to 85°C	0.5%	SC-70 – DCK	Reel of 3000	TLVH431BIDCKR	YJ_
			Reel of 250	TLVH431BIDCKT	
		SOT-23-5 – DBV	Reel of 3000	TLVH431BIDBVR	Y3K_
			Reel of 250	TLVH431BIDBVT	
		SOT-23-3 – DBZ	Reel of 3000	TLVH431BIDBZR	Y3K_
				TLVH432BIDBZR	Y2J_
			Reel of 250	TLVH431BIDBZT	Y3K_
				TLVH432BIDBZT	Y2J_
		SOT-89 – PK	Reel of 1000	TLVH431BIPK	V8
				TLVH432BIPK	VP
		TO-92 – LP	Bulk of 1000	TLVH431BILP	ZB431B
			Reel of 2000	TLVH431BILPR	
	1%	SC-70 – DCK	Reel of 3000	TLVH431AIDCKR	YT_
			Reel of 250	TLVH431AIDCKT	
		SOT-23-5 – DBV	Reel of 3000	TLVH431AIDBVR	Y3T_
			Reel of 250	TLVH431AIDBVT	
		SOT-23-3 – DBZ	Reel of 3000	TLVH431AIDBZR	Y3T_
				TLVH432AIDBZR	Y2F_
			Reel of 250	TLVH431AIDBZT	Y3T_
				TLVH432AIDBZT	Y2F_
		SOT-89 – PK	Reel of 1000	TLVH431AIPK	W3
				TLVH432AIPK	VL
		TO-92 – LP	Bulk of 1000	TLVH431AILP	ZB431A
			Reel of 2000	TLVH431AILPR	
	1.5%	SC-70 – DCK	Reel of 3000	TLVH431IDCKR	YV_
			Reel of 250	TLVH431IDCKT	
		SOT-23-5 – DBV	Reel of 3000	TLVH431IDBVR	Y3V_
			Reel of 250	TLVH431IDBVT	
		SOT-23-3 – DBZ	Reel of 3000	TLVH431IDBZR	Y3V_
				TLVH432IDBZR	Y2B_
Reel of 250			TLVH431IDBZT	Y3V_	
			TLVH432IDBZT	Y2B_	
SOT-89 – PK		Reel of 1000	TLVH431IPK	W5	
			TLVH432IPK	VH	
TO-92 – LP		Bulk of 1000	TLVH431ILP	ZB431	
		Reel of 2000	TLVH431ILPR		

ORDERING INFORMATION (continued)

T_A	V_{REF} TOLERANCE	PACKAGE ⁽¹⁾	ORDERABLE PART NUMBER	TOP-SIDE MARKING ⁽²⁾	
-40°C to 125°C	0.5%	SC-70 – DCK	Reel of 3000	TLVH431BQDCKR	YK_
			Reel of 250	TLVH431BQDCKT	
		SOT-23-5 – DBV	Reel of 3000	TLVH431BQDBVR	Y3L_
			Reel of 250	TLVH431BQDBVT	
		SOT-23-3 – DBZ	Reel of 3000	TLVH431BQDBZR	Y3L_
				TLVH432BQDBZR	Y2K_
			Reel of 250	TLVH431BQDBZT	Y3L_
				TLVH432BQDBZT	Y2K_
		SOT-89 – PK	Reel of 1000	TLVH431BQPK	V9
				TLVH432BQPK	VQ
		TO-92 – LP	Bulk of 1000	TLVH431BQLP	ZD431B
			Reel of 2000	TLVH431BQLPR	
	1%	SC-70 – DCK	Reel of 3000	TLVH431AQDCKR	YN_
			Reel of 250	TLVH431AQDCKT	
		SOT-23-5 – DBV	Reel of 3000	TLVH431AQDBVR	Y3N_
			Reel of 250	TLVH431AQDBVT	
		SOT-23-3 – DBZ	Reel of 3000	TLVH431AQDBZR	Y3N_
				TLVH432AQDBZR	Y2G_
			Reel of 250	TLVH431AQDBZT	Y3N_
				TLVH432AQDBZT	Y2G_
		SOT-89 – PK	Reel of 1000	TLVH431AQPK	VD
				TLVH432AQPK	VM
		TO-92 – LP	Bulk of 1000	TLVH431AQLP	ZD431A
			Reel of 2000	TLVH431AQLPR	
	1.5%	SC-70 – DCK	Reel of 3000	TLVH431QDCKR	YM_
			Reel of 250	TLVH431QDCKT	
		SOT-23-5 – DBV	Reel of 3000	TLVH431QDBVR	Y3M_
			Reel of 250	TLVH431QDBVT	
		SOT-23-3 – DBZ	Reel of 3000	TLVH431QDBZR	Y3M_
				TLVH432QDBZR	Y2D_
Reel of 250			TLVH431QDBZT	Y3M_	
			TLVH432QDBZT	Y2D_	
SOT-89 – PK		Reel of 1000	TLVH431QPK	VC	
			TLVH432QPK	VJ	
TO-92 – LP		Bulk of 1000	TLVH431QLP	ZD431	
		Reel of 2000	TLVH431QLPR		

Absolute Maximum Ratings⁽¹⁾

over operating free-air temperature range (unless otherwise noted)

		MIN	MAX	UNIT
V_{KA}	Cathode voltage ⁽²⁾		20	V
I_K	Cathode current range	-25	80	mA
I_{ref}	Reference current range	-0.05	3	mA
θ_{JA}	Package thermal impedance ⁽³⁾⁽⁴⁾	DBV package		°C/W
		DBZ package		
		DCK package		
		LP package		
		PK package		
T_J	Operating virtual junction temperature		150	°C
T_{stg}	Storage temperature range	-65	150	°C

- (1) Stresses beyond those listed under "absolute maximum ratings" may cause permanent damage to the device. These are stress ratings only, and functional operation of the device at these or any other conditions beyond those indicated under "recommended operating conditions" is not implied. Exposure to absolute-maximum-rated conditions for extended periods may affect device reliability.
- (2) Voltage values are with respect to the anode terminal, unless otherwise noted.
- (3) Maximum power dissipation is a function of $T_J(\max)$, θ_{JA} , and T_A . The maximum allowable power dissipation at any allowable ambient temperature is $P_D = (T_J(\max) - T_A)/\theta_{JA}$. Operating at the absolute maximum T_J of 150°C can affect reliability.
- (4) The package thermal impedance is calculated in accordance with JESD 51-7.

Recommended Operating Conditions

		MIN	MAX	UNIT	
V_{KA}	Cathode voltage	V_{REF}	18	V	
I_K	Cathode current (continuous)	0.1	80	mA	
T_A	Operating free-air temperature	TLVH43X_C	0	70	°C
		TLVH43X_I	-40	85	
		TLVH43X_Q	-40	125	

TLVH431, TLVH431A, TLVH431B TLVH432, TLVH432A, TLVH432B LOW-VOLTAGE ADJUSTABLE PRECISION SHUNT REGULATORS

SLVS555G – NOVEMBER 2004 – REVISED JANUARY 2006

TLVH431 Electrical Characteristics

at 25°C free-air temperature (unless otherwise noted)

PARAMETER	TEST CONDITIONS		TLVH431 TLVH432			UNIT
			MIN	TYP	MAX	
V_{REF} Reference voltage	$V_{KA} = V_{REF}$, $I_K = 10$ mA	$T_A = 25^\circ\text{C}$	1.222	1.24	1.258	V
		$T_A = \text{full range}$, See Figure 1 ⁽¹⁾	TLVH431C	1.21	1.27	
			TLVH431I	1.202	1.278	
			TLVH431Q	1.194	1.286	
$V_{REF(\text{dev})}$ V_{REF} deviation over full temperature range ⁽²⁾	$V_{KA} = V_{REF}$, $I_K = 10$ mA, See Figure 1 ⁽¹⁾	TLVH431C	4	12	mV	
		TLVH431I	6	20		
		TLVH431Q	11	31		
$\frac{\Delta V_{REF}}{\Delta V_{KA}}$ Ratio of V_{REF} change to cathode voltage change	$I_K = 10$ mA, $V_K = V_{REF}$ to 18 V, See Figure 2		-1.5	-2.7	mV/V	
I_{ref} Reference terminal current	$I_K = 10$ mA, $R1 = 10$ k Ω , $R2 = \text{open}$, See Figure 2		0.1	0.5	μA	
$I_{ref(\text{dev})}$ I_{ref} deviation over full temperature range ⁽²⁾	$I_K = 10$ mA, $R1 = 10$ k Ω , $R2 = \text{open}$, See Figure 2 ⁽¹⁾	TLVH431C	0.05	0.3	μA	
		TLVH431I	0.1	0.4		
		TLVH431Q	0.15	0.5		
$I_{K(\text{min})}$ Minimum cathode current for regulation	$V_{KA} = V_{REF}$, See Figure 1		60	100	μA	
$I_{K(\text{off})}$ Off-state cathode current	$V_{REF} = 0$, $V_{KA} = 18$ V, See Figure 3		0.02	0.1	μA	
$ z_{KA} $ Dynamic impedance ⁽³⁾	$V_{KA} = V_{REF}$, $f \leq 1$ kHz, $I_K = 0.1$ mA to 80 mA, See Figure 1		0.25	0.4	Ω	

(1) Full temperature ranges are -40°C to 125°C for TLVH431Q, -40°C to 85°C for TLVH431I, and 0°C to 70°C for TLVH431C.

(2) The deviation parameters $V_{REF(\text{dev})}$ and $I_{ref(\text{dev})}$ are defined as the differences between the maximum and minimum values obtained over the rated temperature range. The average full-range temperature coefficient of the reference input voltage, αV_{REF} , is defined as:

$$|\alpha V_{REF}(\text{ppm}/^\circ\text{C})| = \frac{\left(\frac{V_{REF(\text{dev})}}{V_{REF}(T_A = 25^\circ\text{C})} \right)}{\Delta T_A} \times 10^6$$

where ΔT_A is the rated operating free-air temperature range of the device.

αV_{REF} can be positive or negative, depending on whether minimum V_{REF} or maximum V_{REF} , respectively, occurs at the lower temperature.

(3) The dynamic impedance is defined as:

$$|z_{KA}| = \frac{\Delta V_{KA}}{\Delta I_K}$$

When the device is operating with two external resistors (see Figure 2), the total dynamic impedance of the circuit is defined as:

$$|z_{KA}| = \frac{\Delta V}{\Delta I} \approx |z_{KA}| \times \left(1 + \frac{R1}{R2} \right)$$

TLVH431A Electrical Characteristics

at 25°C free-air temperature (unless otherwise noted)

PARAMETER	TEST CONDITIONS		TLVH431A TLVH432A			UNIT
			MIN	TYP	MAX	
V_{REF} Reference voltage	$V_{KA} = V_{REF}$, $I_K = 10$ mA	$T_A = 25^\circ\text{C}$	1.228	1.24	1.252	V
		$T_A = \text{full range}$, See Figure 1 ⁽¹⁾	TLVH431AC	1.221	1.259	
			TLVH431AI	1.215	1.265	
			TLVH431AQ	1.209	1.271	
$V_{REF(\text{dev})}$ V_{REF} deviation over full temperature range ⁽²⁾	$V_{KA} = V_{REF}$, $I_K = 10$ mA, See Figure 1 ⁽¹⁾	TLVH431AC	4	12	mV	
		TLVH431AI	6	20		
		TLVH431AQ	11	31		
$\frac{\Delta V_{REF}}{\Delta V_{KA}}$ Ratio of V_{REF} change to cathode voltage change	$V_K = V_{REF}$ to 18 V, $I_K = 10$ mA, See Figure 2		-1.5	-2.7	mV/V	
I_{ref} Reference terminal current	$I_K = 10$ mA, $R1 = 10$ k Ω , $R2 = \text{open}$, See Figure 2		0.1	0.5	μA	
$I_{ref(\text{dev})}$ I_{ref} deviation over full temperature range ⁽²⁾	$I_K = 10$ mA, $R1 = 10$ k Ω , $R2 = \text{open}$, See Figure 2 ⁽¹⁾	TLVH431AC	0.05	0.3	μA	
		TLVH431AI	0.1	0.4		
		TLVH431AQ	0.15	0.5		
$I_{K(\text{min})}$ Minimum cathode current for regulation	$V_{KA} = V_{REF}$, See Figure 1		60	100	μA	
$I_{K(\text{off})}$ Off-state cathode current	$V_{REF} = 0$, $V_{KA} = 18$ V, See Figure 3		0.02	0.1	μA	
$ z_{KA} $ Dynamic impedance ⁽³⁾	$V_{KA} = V_{REF}$, $f \leq 1$ kHz, $I_K = 0.1$ mA to 80 mA, See Figure 1		0.25	0.4	Ω	

(1) Full temperature ranges are -40°C to 125°C for TLVH431Q, -40°C to 85°C for TLVH431I, and 0°C to 70°C for TLVH431C.

(2) The deviation parameters $V_{REF(\text{dev})}$ and $I_{ref(\text{dev})}$ are defined as the differences between the maximum and minimum values obtained over the rated temperature range. The average full-range temperature coefficient of the reference input voltage, αV_{REF} , is defined as:

$$|\alpha V_{REF}(\text{ppm}/^\circ\text{C})| = \frac{\left(\frac{V_{REF(\text{dev})}}{V_{REF}(T_A = 25^\circ\text{C})} \right)}{\Delta T_A} \times 10^6$$

where ΔT_A is the rated operating free-air temperature range of the device.

αV_{REF} can be positive or negative, depending on whether minimum V_{REF} or maximum V_{REF} , respectively, occurs at the lower temperature.

(3) The dynamic impedance is defined as:

$$|z_{KA}| = \frac{\Delta V_{KA}}{\Delta I_K}$$

When the device is operating with two external resistors (see Figure 2), the total dynamic impedance of the circuit is defined as:

$$|z_{KA}| = \frac{\Delta V}{\Delta I} \approx |z_{KA}| \times \left(1 + \frac{R1}{R2} \right)$$

TLVH431, TLVH431A, TLVH431B TLVH432, TLVH432A, TLVH432B LOW-VOLTAGE ADJUSTABLE PRECISION SHUNT REGULATORS

SLVS555G—NOVEMBER 2004—REVISED JANUARY 2006

TLVH431B Electrical Characteristics

at 25°C free-air temperature (unless otherwise noted)

PARAMETER	TEST CONDITIONS		TLVH431B TLVH432B			UNIT
			MIN	TYP	MAX	
V_{REF} Reference voltage	$V_{KA} = V_{REF}$, $I_K = 10$ mA	$T_A = 25^\circ\text{C}$	1.234	1.24	1.246	V
		$T_A = \text{full range}$, See Figure 1 ⁽¹⁾	TLVH431BC	1.227	1.253	
			TLVH431BI	1.224	1.259	
			TLVH431BQ	1.221	1.265	
$V_{REF(\text{dev})}$ V_{REF} deviation over full temperature range ⁽²⁾	$V_{KA} = V_{REF}$, $I_K = 10$ mA, See Figure 1 ⁽¹⁾	TLVH431BC	4	12	mV	
		TLVH431BI	6	20		
		TLVH431BQ	11	31		
$\frac{\Delta V_{REF}}{\Delta V_{KA}}$ Ratio of V_{REF} change to cathode voltage change	$I_K = 10$ mA, $V_K = V_{REF}$ to 18 V, See Figure 2		-1.5	-2.7	mV/V	
I_{ref} Reference terminal current	$I_K = 10$ mA, $R1 = 10$ k Ω , $R2 = \text{open}$, See Figure 2		0.1	0.5	μA	
$I_{ref(\text{dev})}$ I_{ref} deviation over full temperature range ⁽²⁾	$I_K = 10$ mA, $R1 = 10$ k Ω , $R2 = \text{open}$, See Figure 2 ⁽¹⁾	TLVH431BC	0.05	0.3	μA	
		TLVH431BI	0.1	0.4		
		TLVH431BQ	0.15	0.5		
$I_{K(\text{min})}$ Minimum cathode current for regulation	$V_{KA} = V_{REF}$, See Figure 1		60	100	μA	
$I_{K(\text{off})}$ Off-state cathode current	$V_{REF} = 0$, $V_{KA} = 18$ V, See Figure 3		0.02	0.1	μA	
$ z_{KA} $ Dynamic impedance ⁽³⁾	$V_{KA} = V_{REF}$, $f \leq 1$ kHz, $I_K = 0.1$ mA to 80 mA, See Figure 1		0.25	0.4	Ω	

(1) Full temperature ranges are -40°C to 125°C for TLVH431Q, -40°C to 85°C for TLVH431I, and 0°C to 70°C for TLVH431C.

(2) The deviation parameters $V_{REF(\text{dev})}$ and $I_{ref(\text{dev})}$ are defined as the differences between the maximum and minimum values obtained over the rated temperature range. The average full-range temperature coefficient of the reference input voltage, αV_{REF} , is defined as:

$$|\alpha V_{REF} \left(\frac{\text{ppm}}{^\circ\text{C}} \right)| = \frac{\left(\frac{V_{REF(\text{dev})}}{V_{REF}(T_A = 25^\circ\text{C})} \right)}{\Delta T_A} \times 10^6$$

where ΔT_A is the rated operating free-air temperature range of the device.

αV_{REF} can be positive or negative, depending on whether minimum V_{REF} or maximum V_{REF} , respectively, occurs at the lower temperature.

(3) The dynamic impedance is defined as:

$$|z_{KA}| = \frac{\Delta V_{KA}}{\Delta I_K}$$

When the device is operating with two external resistors (see [Figure 2](#)), the total dynamic impedance of the circuit is defined as:

$$|z_{KA}| = \frac{\Delta V}{\Delta I} \approx |z_{KA}| \times \left(1 + \frac{R1}{R2} \right)$$

PARAMETER MEASUREMENT INFORMATION

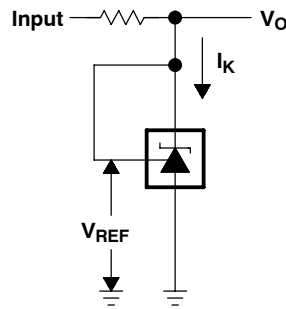

Figure 1. Test Circuit for $V_{KA} = V_{REF}$, $V_O = V_{KA} = V_{REF}$

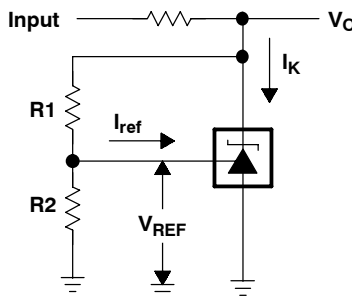

Figure 2. Test Circuit for $V_{KA} > V_{REF}$, $V_O = V_{KA} = V_{REF} \times (1 + R1/R2) + I_{ref} \times R1$

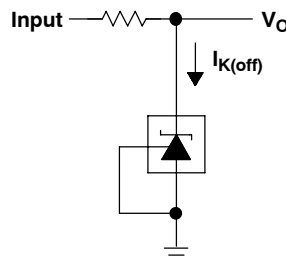

Figure 3. Test Circuit for $I_{K(off)}$

PARAMETER MEASUREMENT INFORMATION (continued)

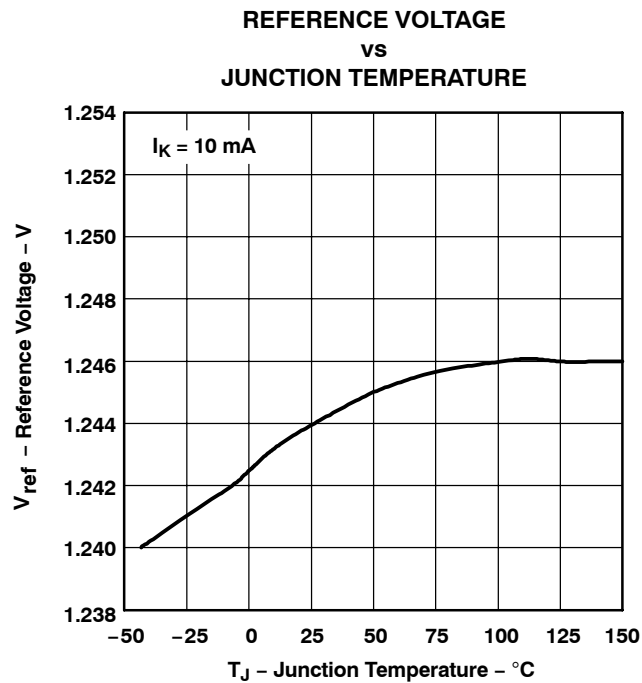

Figure 4.

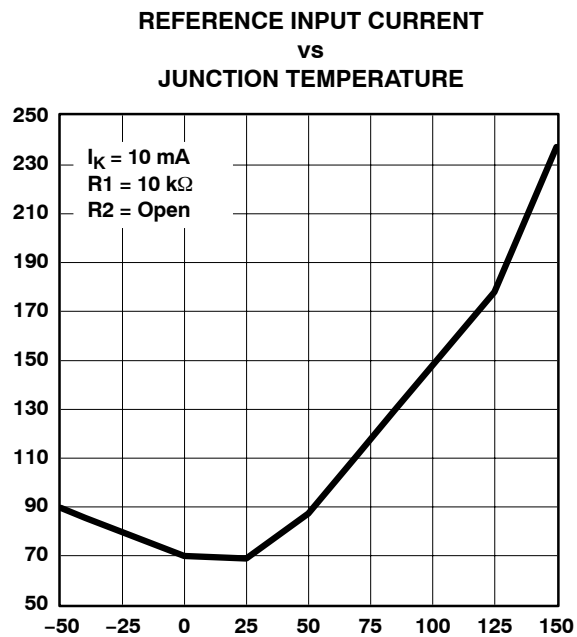

Figure 5.

PARAMETER MEASUREMENT INFORMATION (continued)

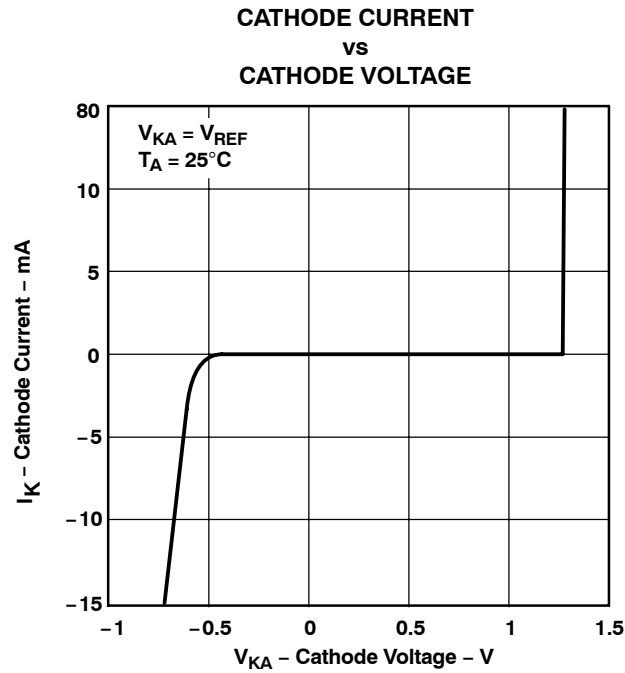

Figure 6.

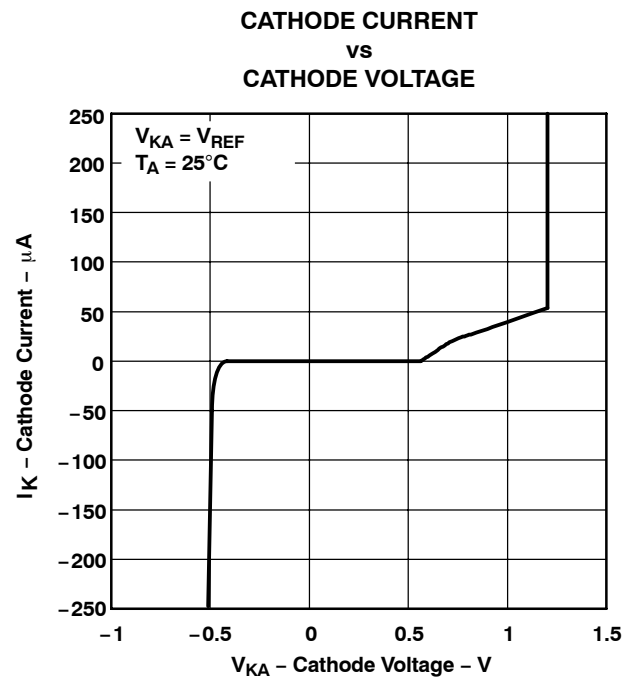

Figure 7.

PARAMETER MEASUREMENT INFORMATION (continued)

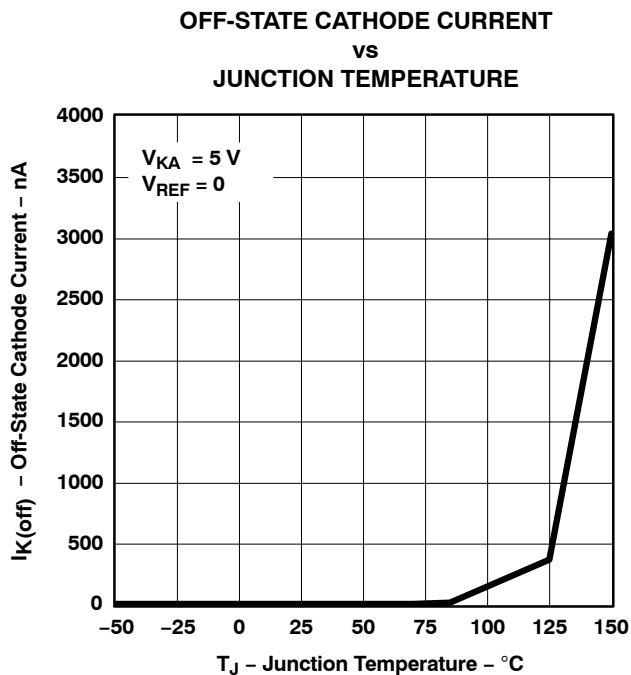

Figure 8.

PARAMETER MEASUREMENT INFORMATION (continued)

Operation of the device at these or any other conditions beyond those indicated under *recommended operating conditions* is not implied.

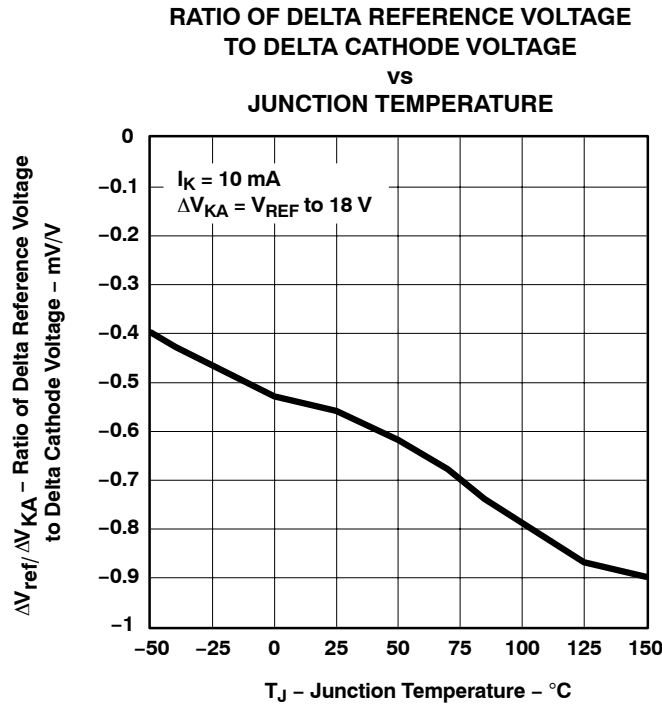
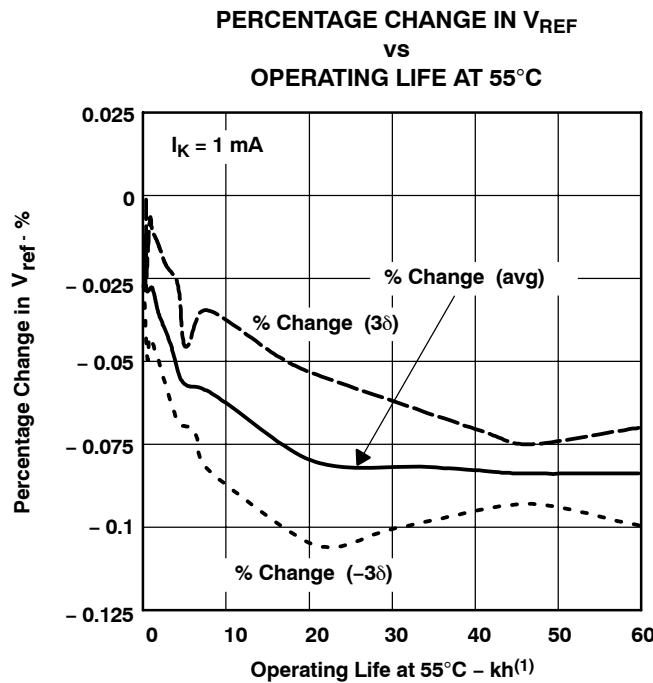

Figure 9.



(1) Extrapolated from life-test data taken at 125°C; the activation energy assumed is 0.7 eV.

Figure 10.

PARAMETER MEASUREMENT INFORMATION (continued)

EQUIVALENT INPUT NOISE VOLTAGE
 VS
 FREQUENCY

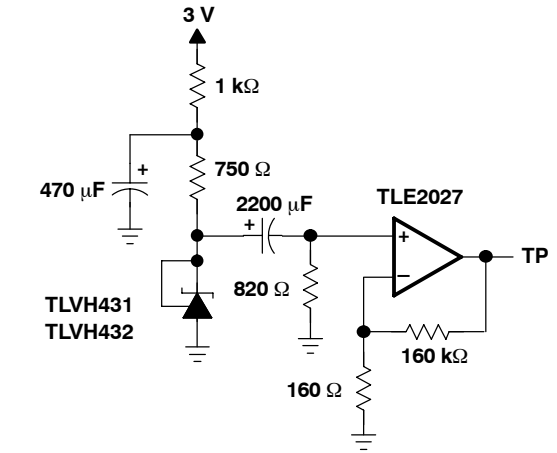
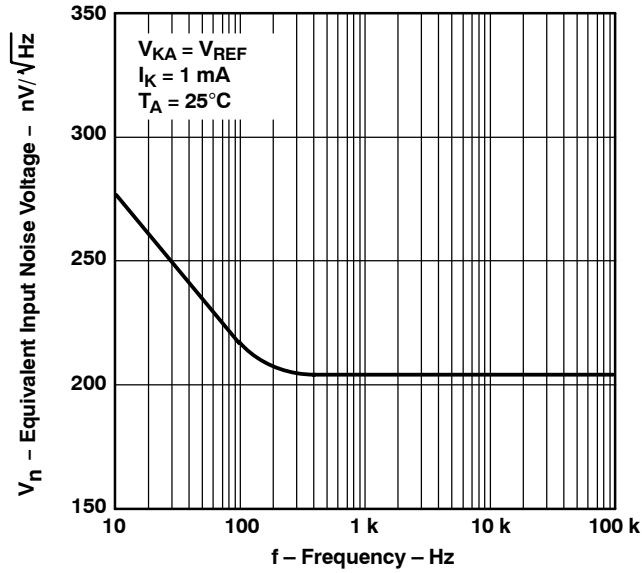

TEST CIRCUIT FOR EQUIVALENT INPUT NOISE VOLTAGE

Figure 11.

PARAMETER MEASUREMENT INFORMATION (continued)

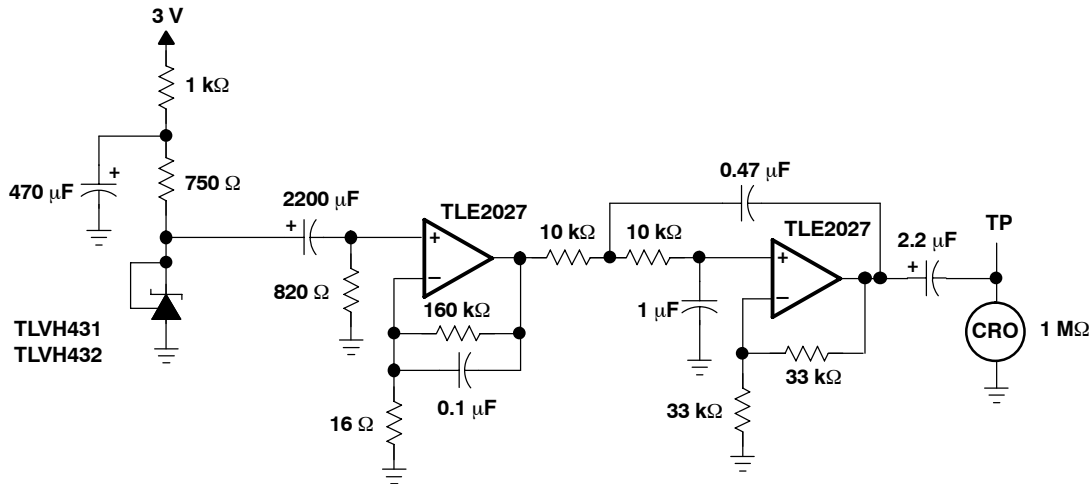
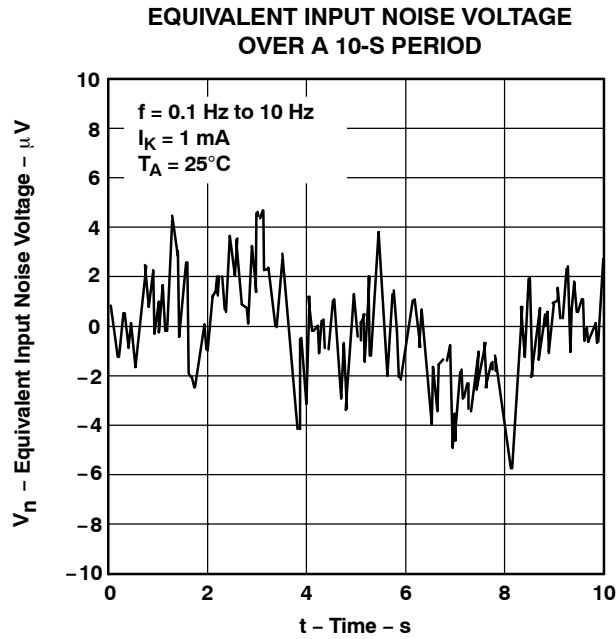

TEST CIRCUIT FOR 0.1-Hz TO 10-Hz EQUIVALENT NOISE VOLTAGE

Figure 12.

PARAMETER MEASUREMENT INFORMATION (continued)

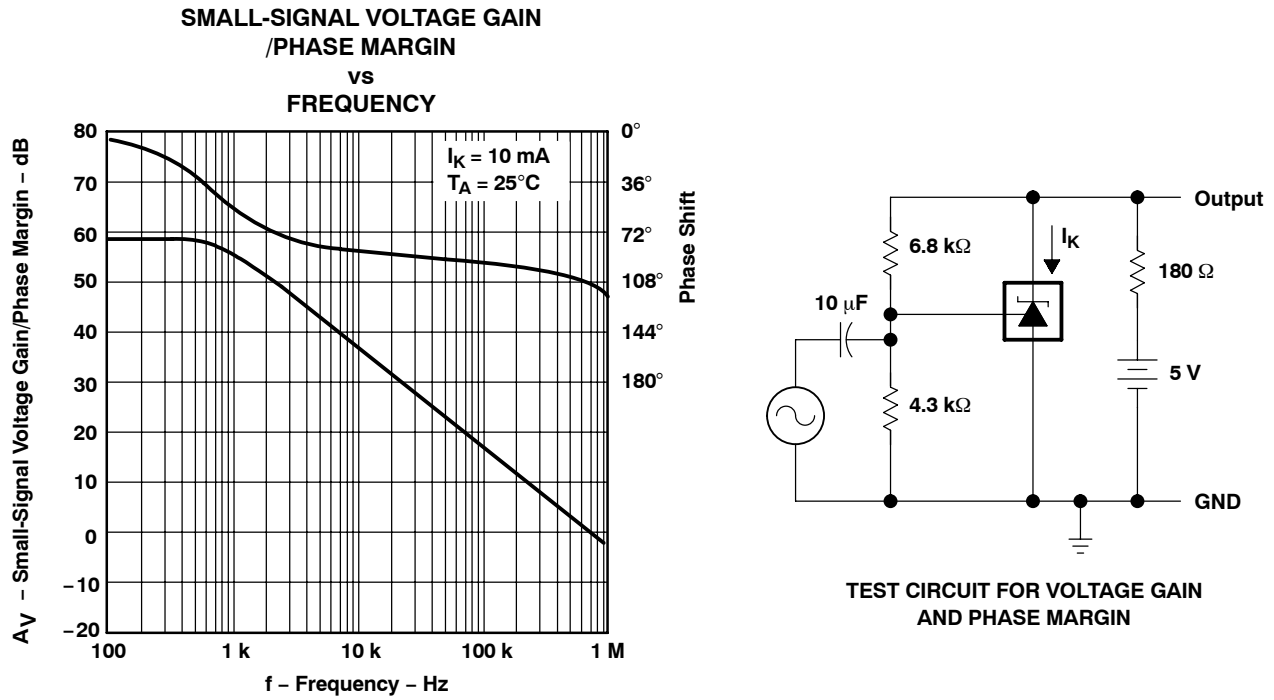

Figure 13.

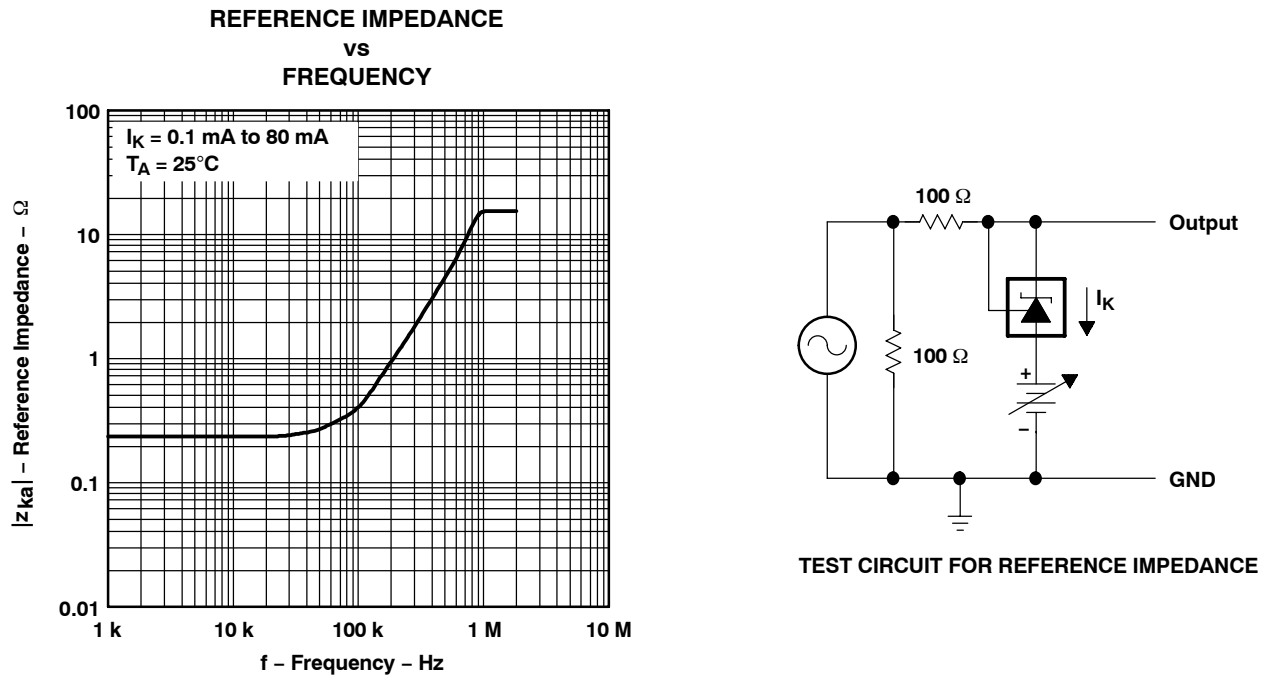

Figure 14.

PARAMETER MEASUREMENT INFORMATION (continued)

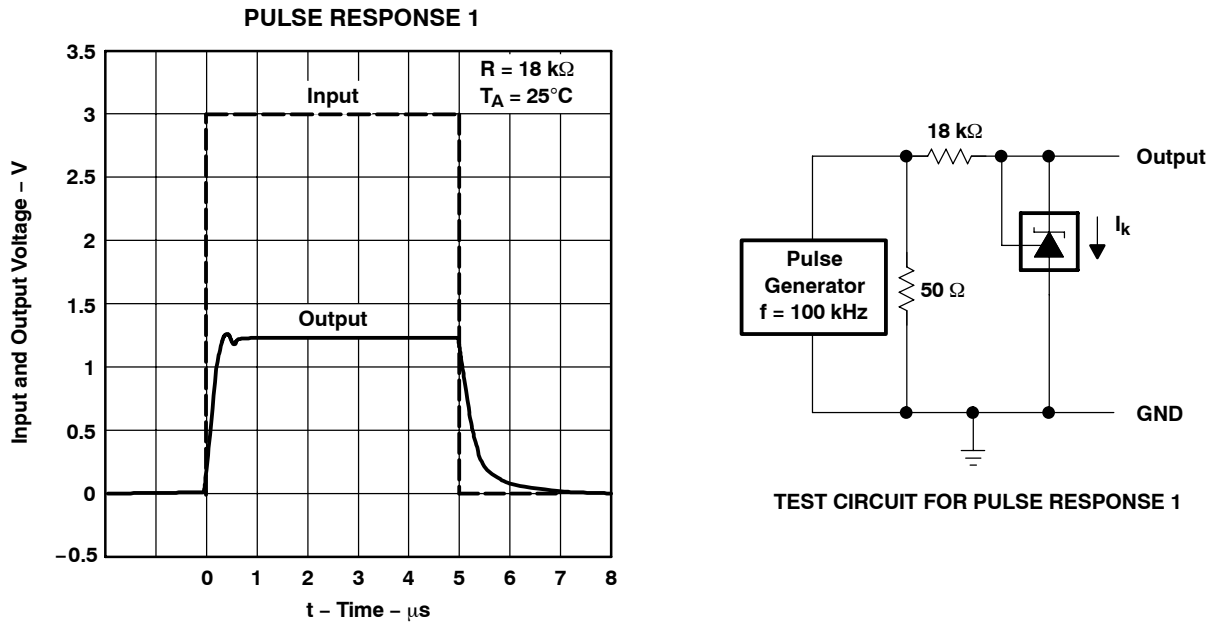

Figure 15.

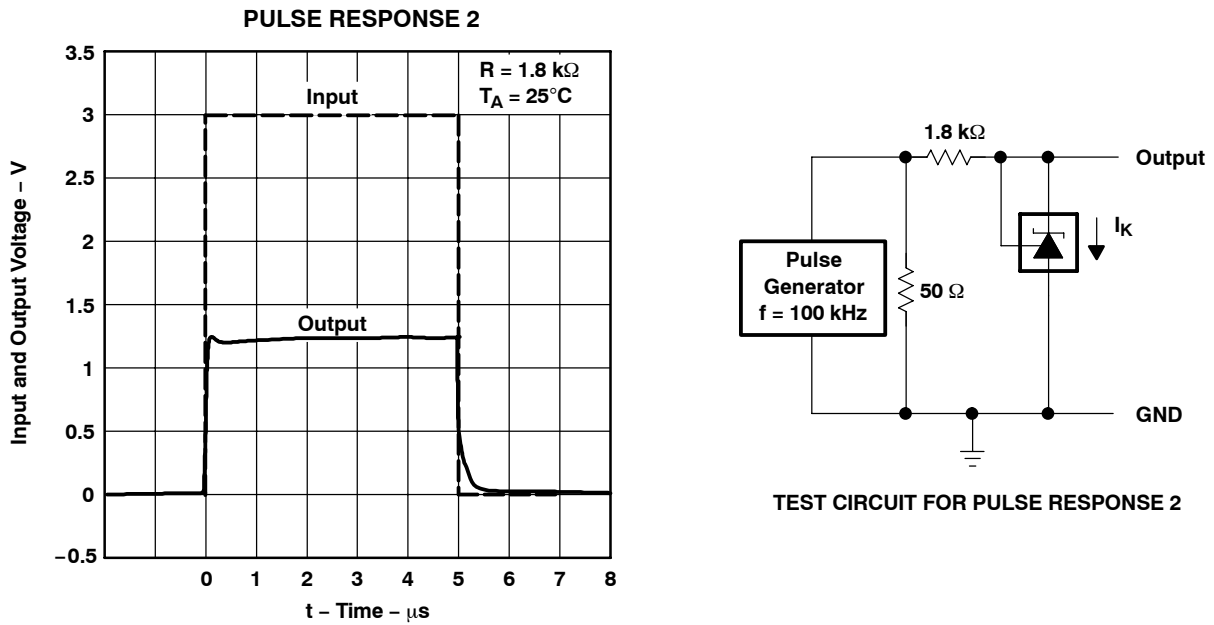
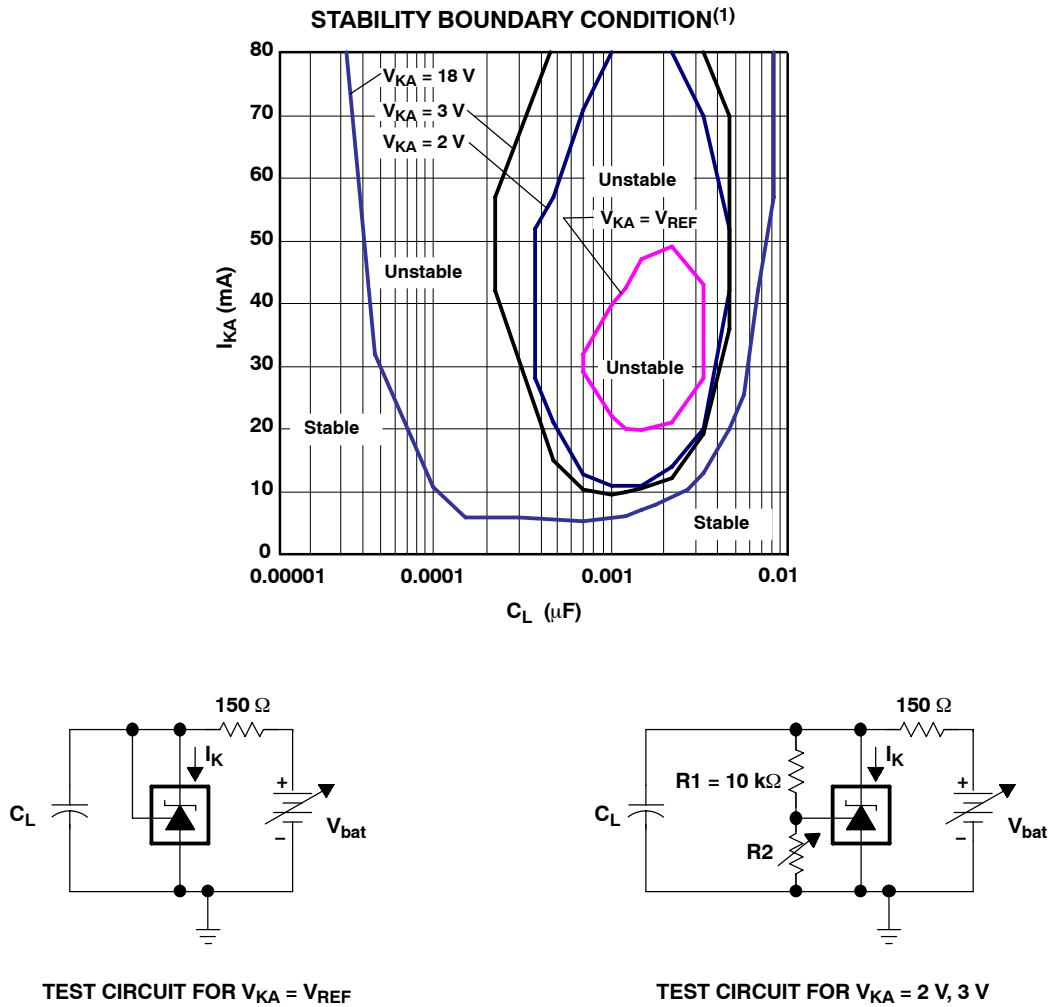

Figure 16.

PARAMETER MEASUREMENT INFORMATION (continued)

Operation of the device at these or any other conditions beyond those indicated under *recommended operating conditions* is not implied.



(1) The areas enclosed by the curves represent conditions that may cause the device to oscillate. For $V_{KA} = 2\text{-V}, 3\text{-V}$, and 18-V curves, R_2 and V_{bat} were adjusted to establish the initial V_{KA} and I_K conditions with $C_L = 0$. V_{bat} and C_L then were adjusted to determine the ranges of stability.

Figure 17.

APPLICATION INFORMATION

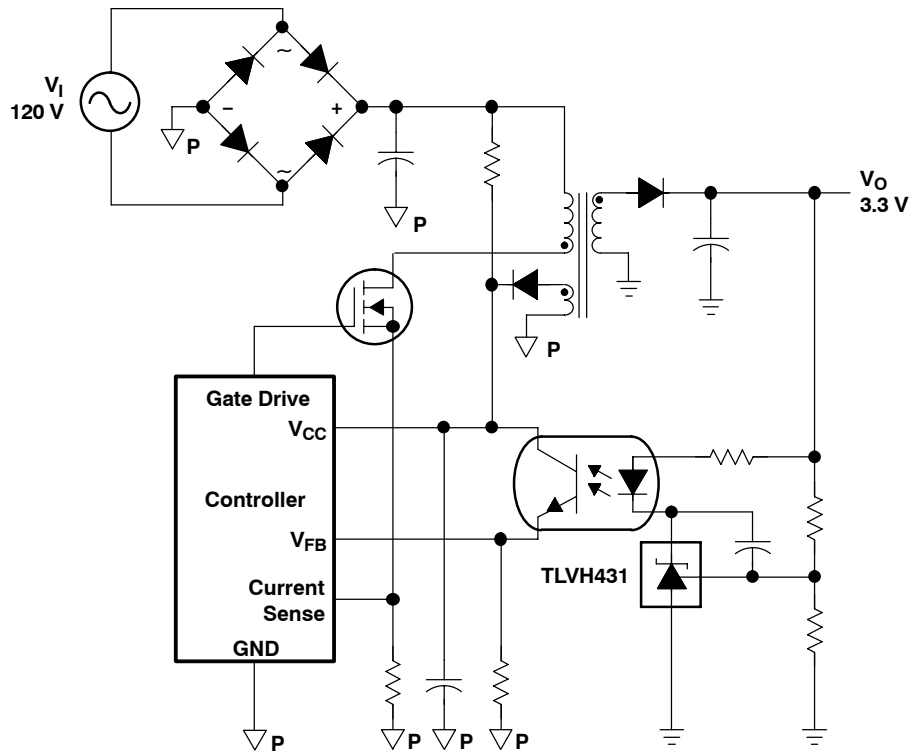

Figure 18. Flyback With Isolation Using TLVH431 and TLVH432 as Voltage Reference and Error Amplifier

Figure 18 shows the TLVH431 used in a 3.3-V isolated flyback supply. Output voltage V_O can be as low as reference voltage V_{REF} (1.24 V). The output of the regulator plus the forward voltage drop of the optocoupler LED ($1.24 + 1.4 = 2.64$ V) determine the minimum voltage that can be regulated in an isolated supply configuration. Regulated voltage as low as 2.7 Vdc is possible in the topology shown in Figure 18.

PACKAGING INFORMATION

Orderable Device	Status ⁽¹⁾	Package Type	Package Drawing	Pins	Package Qty	Eco Plan ⁽²⁾	Lead/Ball Finish	MSL Peak Temp ⁽³⁾
TLVH431ACDBVR	ACTIVE	SOT-23	DBV	5	3000	Green (RoHS & no Sb/Br)	CU NIPDAU	Level-1-260C-UNLIM
TLVH431ACDBVRE4	ACTIVE	SOT-23	DBV	5	3000	Green (RoHS & no Sb/Br)	CU NIPDAU	Level-1-260C-UNLIM
TLVH431ACDBVRG4	ACTIVE	SOT-23	DBV	5	3000	Green (RoHS & no Sb/Br)	CU NIPDAU	Level-1-260C-UNLIM
TLVH431ACDBVT	ACTIVE	SOT-23	DBV	5	250	Green (RoHS & no Sb/Br)	CU NIPDAU	Level-1-260C-UNLIM
TLVH431ACDBVTE4	ACTIVE	SOT-23	DBV	5	250	Green (RoHS & no Sb/Br)	CU NIPDAU	Level-1-260C-UNLIM
TLVH431ACDBVTG4	ACTIVE	SOT-23	DBV	5	250	Green (RoHS & no Sb/Br)	CU NIPDAU	Level-1-260C-UNLIM
TLVH431ACDBZR	ACTIVE	SOT-23	DBZ	3	3000	Green (RoHS & no Sb/Br)	CU NIPDAU	Level-1-260C-UNLIM
TLVH431ACDBZRG4	ACTIVE	SOT-23	DBZ	3	3000	Green (RoHS & no Sb/Br)	CU NIPDAU	Level-1-260C-UNLIM
TLVH431ACDBZT	ACTIVE	SOT-23	DBZ	3	250	Green (RoHS & no Sb/Br)	CU NIPDAU	Level-1-260C-UNLIM
TLVH431ACDBZTG4	ACTIVE	SOT-23	DBZ	3	250	Green (RoHS & no Sb/Br)	CU NIPDAU	Level-1-260C-UNLIM
TLVH431ACDCKR	ACTIVE	SC70	DCK	6	3000	Green (RoHS & no Sb/Br)	CU NIPDAU	Level-1-260C-UNLIM
TLVH431ACDCKRE4	ACTIVE	SC70	DCK	6	3000	Green (RoHS & no Sb/Br)	CU NIPDAU	Level-1-260C-UNLIM
TLVH431ACDCKT	ACTIVE	SC70	DCK	6	250	Green (RoHS & no Sb/Br)	CU NIPDAU	Level-1-260C-UNLIM
TLVH431ACDCKTE4	ACTIVE	SC70	DCK	6	250	Green (RoHS & no Sb/Br)	CU NIPDAU	Level-1-260C-UNLIM
TLVH431ACLPL	ACTIVE	TO-92	LP	3	1000	Pb-Free (RoHS)	CU SN	N / A for Pkg Type
TLVH431ACLPE3	ACTIVE	TO-92	LP	3	1000	Pb-Free (RoHS)	CU SN	N / A for Pkg Type
TLVH431ACLPR	ACTIVE	TO-92	LP	3	2000	Pb-Free (RoHS)	CU SN	N / A for Pkg Type
TLVH431ACLPRE3	ACTIVE	TO-92	LP	3	2000	Pb-Free (RoHS)	CU SN	N / A for Pkg Type
TLVH431ACPK	ACTIVE	SOT-89	PK	3	1000	Green (RoHS & no Sb/Br)	CU SN	Level-2-260C-1YEAR
TLVH431ACPKG3	ACTIVE	SOT-89	PK	3	1000	Green (RoHS & no Sb/Br)	CU SN	Level-2-260C-1YEAR
TLVH431AIDBVR	ACTIVE	SOT-23	DBV	5	3000	Green (RoHS & no Sb/Br)	CU NIPDAU	Level-1-260C-UNLIM
TLVH431AIDBVRE4	ACTIVE	SOT-23	DBV	5	3000	Green (RoHS & no Sb/Br)	CU NIPDAU	Level-1-260C-UNLIM
TLVH431AIDBVT	ACTIVE	SOT-23	DBV	5	250	Green (RoHS & no Sb/Br)	CU NIPDAU	Level-1-260C-UNLIM
TLVH431AIDBVTE4	ACTIVE	SOT-23	DBV	5	250	Green (RoHS & no Sb/Br)	CU NIPDAU	Level-1-260C-UNLIM
TLVH431AIDBZR	ACTIVE	SOT-23	DBZ	3	3000	Green (RoHS & no Sb/Br)	CU NIPDAU	Level-1-260C-UNLIM

Orderable Device	Status ⁽¹⁾	Package Type	Package Drawing	Pins	Package Qty	Eco Plan ⁽²⁾	Lead/Ball Finish	MSL Peak Temp ⁽³⁾
TLVH431AIDBZRG4	ACTIVE	SOT-23	DBZ	3	3000	Green (RoHS & no Sb/Br)	CU NIPDAU	Level-1-260C-UNLIM
TLVH431AIDBZT	ACTIVE	SOT-23	DBZ	3	250	Green (RoHS & no Sb/Br)	CU NIPDAU	Level-1-260C-UNLIM
TLVH431AIDBZTG4	ACTIVE	SOT-23	DBZ	3	250	Green (RoHS & no Sb/Br)	CU NIPDAU	Level-1-260C-UNLIM
TLVH431AIDCKR	ACTIVE	SC70	DCK	6	3000	Green (RoHS & no Sb/Br)	CU NIPDAU	Level-1-260C-UNLIM
TLVH431AIDCKRE4	ACTIVE	SC70	DCK	6	3000	Green (RoHS & no Sb/Br)	CU NIPDAU	Level-1-260C-UNLIM
TLVH431AIDCKT	ACTIVE	SC70	DCK	6	250	Green (RoHS & no Sb/Br)	CU NIPDAU	Level-1-260C-UNLIM
TLVH431AIDCKTE4	ACTIVE	SC70	DCK	6	250	Green (RoHS & no Sb/Br)	CU NIPDAU	Level-1-260C-UNLIM
TLVH431AILP	ACTIVE	TO-92	LP	3	1000	Pb-Free (RoHS)	CU SN	N / A for Pkg Type
TLVH431AILPE3	ACTIVE	TO-92	LP	3	1000	Pb-Free (RoHS)	CU SN	N / A for Pkg Type
TLVH431AILPR	ACTIVE	TO-92	LP	3	2000	Pb-Free (RoHS)	CU SN	N / A for Pkg Type
TLVH431AILPRE3	ACTIVE	TO-92	LP	3	2000	Pb-Free (RoHS)	CU SN	N / A for Pkg Type
TLVH431AIPK	ACTIVE	SOT-89	PK	3	1000	Green (RoHS & no Sb/Br)	CU SN	Level-2-260C-1YEAR
TLVH431AIPKG3	ACTIVE	SOT-89	PK	3	1000	Green (RoHS & no Sb/Br)	CU SN	Level-2-260C-1YEAR
TLVH431AQDBVR	ACTIVE	SOT-23	DBV	5	3000	Green (RoHS & no Sb/Br)	CU NIPDAU	Level-1-260C-UNLIM
TLVH431AQDBVRE4	ACTIVE	SOT-23	DBV	5	3000	Green (RoHS & no Sb/Br)	CU NIPDAU	Level-1-260C-UNLIM
TLVH431AQDBVT	ACTIVE	SOT-23	DBV	5	250	Green (RoHS & no Sb/Br)	CU NIPDAU	Level-1-260C-UNLIM
TLVH431AQDBVTE4	ACTIVE	SOT-23	DBV	5	250	Green (RoHS & no Sb/Br)	CU NIPDAU	Level-1-260C-UNLIM
TLVH431AQDBZR	ACTIVE	SOT-23	DBZ	3	3000	Green (RoHS & no Sb/Br)	CU NIPDAU	Level-1-260C-UNLIM
TLVH431AQDBZRG4	ACTIVE	SOT-23	DBZ	3	3000	Green (RoHS & no Sb/Br)	CU NIPDAU	Level-1-260C-UNLIM
TLVH431AQDBZT	ACTIVE	SOT-23	DBZ	3	250	Green (RoHS & no Sb/Br)	CU NIPDAU	Level-1-260C-UNLIM
TLVH431AQDBZTG4	ACTIVE	SOT-23	DBZ	3	250	Green (RoHS & no Sb/Br)	CU NIPDAU	Level-1-260C-UNLIM
TLVH431AQDCKR	ACTIVE	SC70	DCK	6	3000	Green (RoHS & no Sb/Br)	CU NIPDAU	Level-1-260C-UNLIM
TLVH431AQDCKRE4	ACTIVE	SC70	DCK	6	3000	Green (RoHS & no Sb/Br)	CU NIPDAU	Level-1-260C-UNLIM
TLVH431AQDCKT	ACTIVE	SC70	DCK	6	250	Green (RoHS & no Sb/Br)	CU NIPDAU	Level-1-260C-UNLIM
TLVH431AQDCKTE4	ACTIVE	SC70	DCK	6	250	Green (RoHS & no Sb/Br)	CU NIPDAU	Level-1-260C-UNLIM
TLVH431AQLP	ACTIVE	TO-92	LP	3	1000	Pb-Free (RoHS)	CU SN	N / A for Pkg Type

Orderable Device	Status ⁽¹⁾	Package Type	Package Drawing	Pins	Package Qty	Eco Plan ⁽²⁾	Lead/Ball Finish	MSL Peak Temp ⁽³⁾
TLVH431AQLPE3	ACTIVE	TO-92	LP	3	1000	Pb-Free (RoHS)	CU SN	N / A for Pkg Type
TLVH431AQLPR	ACTIVE	TO-92	LP	3	2000	Pb-Free (RoHS)	CU SN	N / A for Pkg Type
TLVH431AQLPRE3	ACTIVE	TO-92	LP	3	2000	Pb-Free (RoHS)	CU SN	N / A for Pkg Type
TLVH431AQPCK	ACTIVE	SOT-89	PK	3	1000	Green (RoHS & no Sb/Br)	CU SN	Level-2-260C-1YEAR
TLVH431AQPCKG3	ACTIVE	SOT-89	PK	3	1000	Green (RoHS & no Sb/Br)	CU SN	Level-2-260C-1YEAR
TLVH431BCDBVR	ACTIVE	SOT-23	DBV	5	3000	Green (RoHS & no Sb/Br)	CU NIPDAU	Level-1-260C-UNLIM
TLVH431BCDBVRE4	ACTIVE	SOT-23	DBV	5	3000	Green (RoHS & no Sb/Br)	CU NIPDAU	Level-1-260C-UNLIM
TLVH431BCDBVT	ACTIVE	SOT-23	DBV	5	250	Green (RoHS & no Sb/Br)	CU NIPDAU	Level-1-260C-UNLIM
TLVH431BCDBVTE4	ACTIVE	SOT-23	DBV	5	250	Green (RoHS & no Sb/Br)	CU NIPDAU	Level-1-260C-UNLIM
TLVH431BCDBZR	ACTIVE	SOT-23	DBZ	3	3000	Green (RoHS & no Sb/Br)	CU NIPDAU	Level-1-260C-UNLIM
TLVH431BCDBZRG4	ACTIVE	SOT-23	DBZ	3	3000	Green (RoHS & no Sb/Br)	CU NIPDAU	Level-1-260C-UNLIM
TLVH431BCDBZT	ACTIVE	SOT-23	DBZ	3	250	Green (RoHS & no Sb/Br)	CU NIPDAU	Level-1-260C-UNLIM
TLVH431BCDBZTG4	ACTIVE	SOT-23	DBZ	3	250	Green (RoHS & no Sb/Br)	CU NIPDAU	Level-1-260C-UNLIM
TLVH431BCDCKR	ACTIVE	SC70	DCK	6	3000	Green (RoHS & no Sb/Br)	CU NIPDAU	Level-1-260C-UNLIM
TLVH431BCDCKRE4	ACTIVE	SC70	DCK	6	3000	Green (RoHS & no Sb/Br)	CU NIPDAU	Level-1-260C-UNLIM
TLVH431BCDCKT	ACTIVE	SC70	DCK	6	250	Green (RoHS & no Sb/Br)	CU NIPDAU	Level-1-260C-UNLIM
TLVH431BCDCKTE4	ACTIVE	SC70	DCK	6	250	Green (RoHS & no Sb/Br)	CU NIPDAU	Level-1-260C-UNLIM
TLVH431BCLP	ACTIVE	TO-92	LP	3	1000	Pb-Free (RoHS)	CU SN	N / A for Pkg Type
TLVH431BCLPE3	ACTIVE	TO-92	LP	3	1000	Pb-Free (RoHS)	CU SN	N / A for Pkg Type
TLVH431BCLPR	ACTIVE	TO-92	LP	3	2000	Pb-Free (RoHS)	CU SN	N / A for Pkg Type
TLVH431BCLPRE3	ACTIVE	TO-92	LP	3	2000	Pb-Free (RoHS)	CU SN	N / A for Pkg Type
TLVH431BCPK	ACTIVE	SOT-89	PK	3	1000	Green (RoHS & no Sb/Br)	CU SN	Level-2-260C-1YEAR
TLVH431BCPKG3	ACTIVE	SOT-89	PK	3	1000	Green (RoHS & no Sb/Br)	CU SN	Level-2-260C-1YEAR
TLVH431BIDBVR	ACTIVE	SOT-23	DBV	5	3000	Green (RoHS & no Sb/Br)	CU NIPDAU	Level-1-260C-UNLIM
TLVH431BIDBVRE4	ACTIVE	SOT-23	DBV	5	3000	Green (RoHS & no Sb/Br)	CU NIPDAU	Level-1-260C-UNLIM
TLVH431BIDBVT	ACTIVE	SOT-23	DBV	5	250	Green (RoHS & no Sb/Br)	CU NIPDAU	Level-1-260C-UNLIM

Orderable Device	Status ⁽¹⁾	Package Type	Package Drawing	Pins	Package Qty	Eco Plan ⁽²⁾	Lead/Ball Finish	MSL Peak Temp ⁽³⁾
TLVH431BIDBVTE4	ACTIVE	SOT-23	DBV	5	250	Green (RoHS & no Sb/Br)	CU NIPDAU	Level-1-260C-UNLIM
TLVH431BIDBZR	ACTIVE	SOT-23	DBZ	3	3000	Green (RoHS & no Sb/Br)	CU NIPDAU	Level-1-260C-UNLIM
TLVH431BIDBZRG4	ACTIVE	SOT-23	DBZ	3	3000	Green (RoHS & no Sb/Br)	CU NIPDAU	Level-1-260C-UNLIM
TLVH431BIDBZT	ACTIVE	SOT-23	DBZ	3	250	Green (RoHS & no Sb/Br)	CU NIPDAU	Level-1-260C-UNLIM
TLVH431BIDBZTG4	ACTIVE	SOT-23	DBZ	3	250	Green (RoHS & no Sb/Br)	CU NIPDAU	Level-1-260C-UNLIM
TLVH431BIDCKR	ACTIVE	SC70	DCK	6	3000	Green (RoHS & no Sb/Br)	CU NIPDAU	Level-1-260C-UNLIM
TLVH431BIDCKRE4	ACTIVE	SC70	DCK	6	3000	Green (RoHS & no Sb/Br)	CU NIPDAU	Level-1-260C-UNLIM
TLVH431BIDCKT	ACTIVE	SC70	DCK	6	250	Green (RoHS & no Sb/Br)	CU NIPDAU	Level-1-260C-UNLIM
TLVH431BIDCKTE4	ACTIVE	SC70	DCK	6	250	Green (RoHS & no Sb/Br)	CU NIPDAU	Level-1-260C-UNLIM
TLVH431BILP	ACTIVE	TO-92	LP	3	1000	Pb-Free (RoHS)	CU SN	N / A for Pkg Type
TLVH431BILPE3	ACTIVE	TO-92	LP	3	1000	Pb-Free (RoHS)	CU SN	N / A for Pkg Type
TLVH431BILPR	ACTIVE	TO-92	LP	3	2000	Pb-Free (RoHS)	CU SN	N / A for Pkg Type
TLVH431BILPRE3	ACTIVE	TO-92	LP	3	2000	Pb-Free (RoHS)	CU SN	N / A for Pkg Type
TLVH431BIPK	ACTIVE	SOT-89	PK	3	1000	Green (RoHS & no Sb/Br)	CU SN	Level-2-260C-1YEAR
TLVH431BIPKG3	ACTIVE	SOT-89	PK	3	1000	Green (RoHS & no Sb/Br)	CU SN	Level-2-260C-1YEAR
TLVH431BQDBVR	ACTIVE	SOT-23	DBV	5	3000	Green (RoHS & no Sb/Br)	CU NIPDAU	Level-1-260C-UNLIM
TLVH431BQDBVRE4	ACTIVE	SOT-23	DBV	5	3000	Green (RoHS & no Sb/Br)	CU NIPDAU	Level-1-260C-UNLIM
TLVH431BQDBVT	ACTIVE	SOT-23	DBV	5	250	Green (RoHS & no Sb/Br)	CU NIPDAU	Level-1-260C-UNLIM
TLVH431BQDBVTE4	ACTIVE	SOT-23	DBV	5	250	Green (RoHS & no Sb/Br)	CU NIPDAU	Level-1-260C-UNLIM
TLVH431BQDBZR	ACTIVE	SOT-23	DBZ	3	3000	Green (RoHS & no Sb/Br)	CU NIPDAU	Level-1-260C-UNLIM
TLVH431BQDBZRG4	ACTIVE	SOT-23	DBZ	3	3000	Green (RoHS & no Sb/Br)	CU NIPDAU	Level-1-260C-UNLIM
TLVH431BQDBZT	ACTIVE	SOT-23	DBZ	3	250	Green (RoHS & no Sb/Br)	CU NIPDAU	Level-1-260C-UNLIM
TLVH431BQDBZTG4	ACTIVE	SOT-23	DBZ	3	250	Green (RoHS & no Sb/Br)	CU NIPDAU	Level-1-260C-UNLIM
TLVH431BQDCKR	ACTIVE	SC70	DCK	6	3000	Green (RoHS & no Sb/Br)	CU NIPDAU	Level-1-260C-UNLIM
TLVH431BQDCKRE4	ACTIVE	SC70	DCK	6	3000	Green (RoHS & no Sb/Br)	CU NIPDAU	Level-1-260C-UNLIM
TLVH431BQDCKT	ACTIVE	SC70	DCK	6	250	Green (RoHS & no Sb/Br)	CU NIPDAU	Level-1-260C-UNLIM

Orderable Device	Status ⁽¹⁾	Package Type	Package Drawing	Pins	Package Qty	Eco Plan ⁽²⁾	Lead/Ball Finish	MSL Peak Temp ⁽³⁾
TLVH431BQDCKTE4	ACTIVE	SC70	DCK	6	250	Green (RoHS & no Sb/Br)	CU NIPDAU	Level-1-260C-UNLIM
TLVH431BQLP	ACTIVE	TO-92	LP	3	1000	Pb-Free (RoHS)	CU SN	N / A for Pkg Type
TLVH431BQLPE3	ACTIVE	TO-92	LP	3	1000	Pb-Free (RoHS)	CU SN	N / A for Pkg Type
TLVH431BQLPR	ACTIVE	TO-92	LP	3	2000	Pb-Free (RoHS)	CU SN	N / A for Pkg Type
TLVH431BQLPRE3	ACTIVE	TO-92	LP	3	2000	Pb-Free (RoHS)	CU SN	N / A for Pkg Type
TLVH431BQPK	ACTIVE	SOT-89	PK	3	1000	Green (RoHS & no Sb/Br)	CU SN	Level-2-260C-1YEAR
TLVH431BQPKG3	ACTIVE	SOT-89	PK	3	1000	Green (RoHS & no Sb/Br)	CU SN	Level-2-260C-1YEAR
TLVH431CDBVR	ACTIVE	SOT-23	DBV	5	3000	Green (RoHS & no Sb/Br)	CU NIPDAU	Level-1-260C-UNLIM
TLVH431CDBVRE4	ACTIVE	SOT-23	DBV	5	3000	Green (RoHS & no Sb/Br)	CU NIPDAU	Level-1-260C-UNLIM
TLVH431CDBVT	ACTIVE	SOT-23	DBV	5	250	Green (RoHS & no Sb/Br)	CU NIPDAU	Level-1-260C-UNLIM
TLVH431CDBVTE4	ACTIVE	SOT-23	DBV	5	250	Green (RoHS & no Sb/Br)	CU NIPDAU	Level-1-260C-UNLIM
TLVH431CDBZR	ACTIVE	SOT-23	DBZ	3	3000	Green (RoHS & no Sb/Br)	CU NIPDAU	Level-1-260C-UNLIM
TLVH431CDBZRG4	ACTIVE	SOT-23	DBZ	3	3000	Green (RoHS & no Sb/Br)	CU NIPDAU	Level-1-260C-UNLIM
TLVH431CDBZT	ACTIVE	SOT-23	DBZ	3	250	Green (RoHS & no Sb/Br)	CU NIPDAU	Level-1-260C-UNLIM
TLVH431CDBZTG4	ACTIVE	SOT-23	DBZ	3	250	Green (RoHS & no Sb/Br)	CU NIPDAU	Level-1-260C-UNLIM
TLVH431CDCKR	ACTIVE	SC70	DCK	6	3000	Green (RoHS & no Sb/Br)	CU NIPDAU	Level-1-260C-UNLIM
TLVH431CDCKRE4	ACTIVE	SC70	DCK	6	3000	Green (RoHS & no Sb/Br)	CU NIPDAU	Level-1-260C-UNLIM
TLVH431CDCKT	ACTIVE	SC70	DCK	6	250	Green (RoHS & no Sb/Br)	CU NIPDAU	Level-1-260C-UNLIM
TLVH431CDCKTE4	ACTIVE	SC70	DCK	6	250	Green (RoHS & no Sb/Br)	CU NIPDAU	Level-1-260C-UNLIM
TLVH431CLP	ACTIVE	TO-92	LP	3	1000	Pb-Free (RoHS)	CU SN	N / A for Pkg Type
TLVH431CLPE3	ACTIVE	TO-92	LP	3	1000	Pb-Free (RoHS)	CU SN	N / A for Pkg Type
TLVH431CLPR	ACTIVE	TO-92	LP	3	2000	Pb-Free (RoHS)	CU SN	N / A for Pkg Type
TLVH431CLPRE3	ACTIVE	TO-92	LP	3	2000	Pb-Free (RoHS)	CU SN	N / A for Pkg Type
TLVH431CPK	ACTIVE	SOT-89	PK	3	1000	Green (RoHS & no Sb/Br)	CU SN	Level-2-260C-1YEAR
TLVH431CPKG3	ACTIVE	SOT-89	PK	3	1000	Green (RoHS & no Sb/Br)	CU SN	Level-2-260C-1YEAR
TLVH431IBQDBZR	PREVIEW	SOT-23	DBZ	3		TBD	Call TI	Call TI

Orderable Device	Status ⁽¹⁾	Package Type	Package Drawing	Pins	Package Qty	Eco Plan ⁽²⁾	Lead/Ball Finish	MSL Peak Temp ⁽³⁾
TLVH431IDBVR	ACTIVE	SOT-23	DBV	5	3000	Green (RoHS & no Sb/Br)	CU NIPDAU	Level-1-260C-UNLIM
TLVH431IDBVRE4	ACTIVE	SOT-23	DBV	5	3000	Green (RoHS & no Sb/Br)	CU NIPDAU	Level-1-260C-UNLIM
TLVH431IDBVT	ACTIVE	SOT-23	DBV	5	250	Green (RoHS & no Sb/Br)	CU NIPDAU	Level-1-260C-UNLIM
TLVH431IDBVTE4	ACTIVE	SOT-23	DBV	5	250	Green (RoHS & no Sb/Br)	CU NIPDAU	Level-1-260C-UNLIM
TLVH431IDBZR	ACTIVE	SOT-23	DBZ	3	3000	Green (RoHS & no Sb/Br)	CU NIPDAU	Level-1-260C-UNLIM
TLVH431IDBZRG4	ACTIVE	SOT-23	DBZ	3	3000	Green (RoHS & no Sb/Br)	CU NIPDAU	Level-1-260C-UNLIM
TLVH431IDBZT	ACTIVE	SOT-23	DBZ	3	250	Green (RoHS & no Sb/Br)	CU NIPDAU	Level-1-260C-UNLIM
TLVH431IDBZTG4	ACTIVE	SOT-23	DBZ	3	250	Green (RoHS & no Sb/Br)	CU NIPDAU	Level-1-260C-UNLIM
TLVH431IDCKR	ACTIVE	SC70	DCK	6	3000	Green (RoHS & no Sb/Br)	CU NIPDAU	Level-1-260C-UNLIM
TLVH431IDCKRE4	ACTIVE	SC70	DCK	6	3000	Green (RoHS & no Sb/Br)	CU NIPDAU	Level-1-260C-UNLIM
TLVH431IDCKT	ACTIVE	SC70	DCK	6	250	Green (RoHS & no Sb/Br)	CU NIPDAU	Level-1-260C-UNLIM
TLVH431IDCKTE4	ACTIVE	SC70	DCK	6	250	Green (RoHS & no Sb/Br)	CU NIPDAU	Level-1-260C-UNLIM
TLVH431ILP	ACTIVE	TO-92	LP	3	1000	Pb-Free (RoHS)	CU SN	N / A for Pkg Type
TLVH431ILPE3	ACTIVE	TO-92	LP	3	1000	Pb-Free (RoHS)	CU SN	N / A for Pkg Type
TLVH431ILPR	ACTIVE	TO-92	LP	3	2000	Pb-Free (RoHS)	CU SN	N / A for Pkg Type
TLVH431ILPRE3	ACTIVE	TO-92	LP	3	2000	Pb-Free (RoHS)	CU SN	N / A for Pkg Type
TLVH431IPK	ACTIVE	SOT-89	PK	3	1000	Green (RoHS & no Sb/Br)	CU SN	Level-2-260C-1YEAR
TLVH431IPKG3	ACTIVE	SOT-89	PK	3	1000	Green (RoHS & no Sb/Br)	CU SN	Level-2-260C-1YEAR
TLVH431QDBVR	ACTIVE	SOT-23	DBV	5	3000	Green (RoHS & no Sb/Br)	CU NIPDAU	Level-1-260C-UNLIM
TLVH431QDBVRE4	ACTIVE	SOT-23	DBV	5	3000	Green (RoHS & no Sb/Br)	CU NIPDAU	Level-1-260C-UNLIM
TLVH431QDBVT	ACTIVE	SOT-23	DBV	5	250	Green (RoHS & no Sb/Br)	CU NIPDAU	Level-1-260C-UNLIM
TLVH431QDBVTE4	ACTIVE	SOT-23	DBV	5	250	Green (RoHS & no Sb/Br)	CU NIPDAU	Level-1-260C-UNLIM
TLVH431QDBZR	ACTIVE	SOT-23	DBZ	3	3000	Green (RoHS & no Sb/Br)	CU NIPDAU	Level-1-260C-UNLIM
TLVH431QDBZRG4	ACTIVE	SOT-23	DBZ	3	3000	Green (RoHS & no Sb/Br)	CU NIPDAU	Level-1-260C-UNLIM
TLVH431QDBZT	ACTIVE	SOT-23	DBZ	3	250	Green (RoHS & no Sb/Br)	CU NIPDAU	Level-1-260C-UNLIM
TLVH431QDBZTG4	ACTIVE	SOT-23	DBZ	3	250	Green (RoHS & no Sb/Br)	CU NIPDAU	Level-1-260C-UNLIM

Orderable Device	Status ⁽¹⁾	Package Type	Package Drawing	Pins	Package Qty	Eco Plan ⁽²⁾	Lead/Ball Finish	MSL Peak Temp ⁽³⁾
TLVH431QDCKR	ACTIVE	SC70	DCK	6	3000	Green (RoHS & no Sb/Br)	CU NIPDAU	Level-1-260C-UNLIM
TLVH431QDCKRE4	ACTIVE	SC70	DCK	6	3000	Green (RoHS & no Sb/Br)	CU NIPDAU	Level-1-260C-UNLIM
TLVH431QDCKT	ACTIVE	SC70	DCK	6	250	Green (RoHS & no Sb/Br)	CU NIPDAU	Level-1-260C-UNLIM
TLVH431QDCKTE4	ACTIVE	SC70	DCK	6	250	Green (RoHS & no Sb/Br)	CU NIPDAU	Level-1-260C-UNLIM
TLVH431QLP	ACTIVE	TO-92	LP	3	1000	Pb-Free (RoHS)	CU SN	N / A for Pkg Type
TLVH431QLPE3	ACTIVE	TO-92	LP	3	1000	Pb-Free (RoHS)	CU SN	N / A for Pkg Type
TLVH431QLPR	ACTIVE	TO-92	LP	3	2000	Pb-Free (RoHS)	CU SN	N / A for Pkg Type
TLVH431QLPRE3	ACTIVE	TO-92	LP	3	2000	Pb-Free (RoHS)	CU SN	N / A for Pkg Type
TLVH431QPK	ACTIVE	SOT-89	PK	3	1000	Green (RoHS & no Sb/Br)	CU SN	Level-2-260C-1YEAR
TLVH431QPKG3	ACTIVE	SOT-89	PK	3	1000	Green (RoHS & no Sb/Br)	CU SN	Level-2-260C-1YEAR
TLVH432ACDBZR	ACTIVE	SOT-23	DBZ	3	3000	Green (RoHS & no Sb/Br)	CU NIPDAU	Level-1-260C-UNLIM
TLVH432ACDBZRG4	ACTIVE	SOT-23	DBZ	3	3000	Green (RoHS & no Sb/Br)	CU NIPDAU	Level-1-260C-UNLIM
TLVH432ACDBZT	ACTIVE	SOT-23	DBZ	3	250	Green (RoHS & no Sb/Br)	CU NIPDAU	Level-1-260C-UNLIM
TLVH432ACDBZTG4	ACTIVE	SOT-23	DBZ	3	250	Green (RoHS & no Sb/Br)	CU NIPDAU	Level-1-260C-UNLIM
TLVH432ACPK	ACTIVE	SOT-89	PK	3	1000	Green (RoHS & no Sb/Br)	CU SN	Level-2-260C-1YEAR
TLVH432ACPKG3	ACTIVE	SOT-89	PK	3	1000	Green (RoHS & no Sb/Br)	CU SN	Level-2-260C-1YEAR
TLVH432AIDBZR	ACTIVE	SOT-23	DBZ	3	3000	Green (RoHS & no Sb/Br)	CU NIPDAU	Level-1-260C-UNLIM
TLVH432AIDBZRG4	ACTIVE	SOT-23	DBZ	3	3000	Green (RoHS & no Sb/Br)	CU NIPDAU	Level-1-260C-UNLIM
TLVH432AIDBZT	ACTIVE	SOT-23	DBZ	3	250	Green (RoHS & no Sb/Br)	CU NIPDAU	Level-1-260C-UNLIM
TLVH432AIDBZTG4	ACTIVE	SOT-23	DBZ	3	250	Green (RoHS & no Sb/Br)	CU NIPDAU	Level-1-260C-UNLIM
TLVH432AIPK	ACTIVE	SOT-89	PK	3	1000	Green (RoHS & no Sb/Br)	CU SN	Level-2-260C-1YEAR
TLVH432AIPKG3	ACTIVE	SOT-89	PK	3	1000	Green (RoHS & no Sb/Br)	CU SN	Level-2-260C-1YEAR
TLVH432AQDBZR	ACTIVE	SOT-23	DBZ	3	3000	Green (RoHS & no Sb/Br)	CU NIPDAU	Level-1-260C-UNLIM
TLVH432AQDBZRG4	ACTIVE	SOT-23	DBZ	3	3000	Green (RoHS & no Sb/Br)	CU NIPDAU	Level-1-260C-UNLIM
TLVH432AQDBZT	ACTIVE	SOT-23	DBZ	3	250	Green (RoHS & no Sb/Br)	CU NIPDAU	Level-1-260C-UNLIM
TLVH432AQDBZTG4	ACTIVE	SOT-23	DBZ	3	250	Green (RoHS & no Sb/Br)	CU NIPDAU	Level-1-260C-UNLIM

Orderable Device	Status ⁽¹⁾	Package Type	Package Drawing	Pins	Package Qty	Eco Plan ⁽²⁾	Lead/Ball Finish	MSL Peak Temp ⁽³⁾
TLVH432AQP	ACTIVE	SOT-89	PK	3	1000	Green (RoHS & no Sb/Br)	CU SN	Level-2-260C-1YEAR
TLVH432AQP3	ACTIVE	SOT-89	PK	3	1000	Green (RoHS & no Sb/Br)	CU SN	Level-2-260C-1YEAR
TLVH432BCDBZR	ACTIVE	SOT-23	DBZ	3	3000	Green (RoHS & no Sb/Br)	CU NIPDAU	Level-1-260C-UNLIM
TLVH432BCDBZRG4	ACTIVE	SOT-23	DBZ	3	3000	Green (RoHS & no Sb/Br)	CU NIPDAU	Level-1-260C-UNLIM
TLVH432BCDBZT	ACTIVE	SOT-23	DBZ	3	250	Green (RoHS & no Sb/Br)	CU NIPDAU	Level-1-260C-UNLIM
TLVH432BCDBZTG4	ACTIVE	SOT-23	DBZ	3	250	Green (RoHS & no Sb/Br)	CU NIPDAU	Level-1-260C-UNLIM
TLVH432BCPK	ACTIVE	SOT-89	PK	3	1000	Green (RoHS & no Sb/Br)	CU SN	Level-2-260C-1YEAR
TLVH432BCPKG3	ACTIVE	SOT-89	PK	3	1000	Green (RoHS & no Sb/Br)	CU SN	Level-2-260C-1YEAR
TLVH432BIDBZR	ACTIVE	SOT-23	DBZ	3	3000	Green (RoHS & no Sb/Br)	CU NIPDAU	Level-1-260C-UNLIM
TLVH432BIDBZRG4	ACTIVE	SOT-23	DBZ	3	3000	Green (RoHS & no Sb/Br)	CU NIPDAU	Level-1-260C-UNLIM
TLVH432BIDBZT	ACTIVE	SOT-23	DBZ	3	250	Green (RoHS & no Sb/Br)	CU NIPDAU	Level-1-260C-UNLIM
TLVH432BIDBZTG4	ACTIVE	SOT-23	DBZ	3	250	Green (RoHS & no Sb/Br)	CU NIPDAU	Level-1-260C-UNLIM
TLVH432BIPK	ACTIVE	SOT-89	PK	3	1000	Green (RoHS & no Sb/Br)	CU SN	Level-2-260C-1YEAR
TLVH432BIPK3	ACTIVE	SOT-89	PK	3	1000	Green (RoHS & no Sb/Br)	CU SN	Level-2-260C-1YEAR
TLVH432BQDBZR	ACTIVE	SOT-23	DBZ	3	3000	Green (RoHS & no Sb/Br)	CU NIPDAU	Level-1-260C-UNLIM
TLVH432BQDBZRG4	ACTIVE	SOT-23	DBZ	3	3000	Green (RoHS & no Sb/Br)	CU NIPDAU	Level-1-260C-UNLIM
TLVH432BQDBZT	ACTIVE	SOT-23	DBZ	3	250	Green (RoHS & no Sb/Br)	CU NIPDAU	Level-1-260C-UNLIM
TLVH432BQDBZTG4	ACTIVE	SOT-23	DBZ	3	250	Green (RoHS & no Sb/Br)	CU NIPDAU	Level-1-260C-UNLIM
TLVH432BQPK	ACTIVE	SOT-89	PK	3	1000	Green (RoHS & no Sb/Br)	CU SN	Level-2-260C-1YEAR
TLVH432BQPKG3	ACTIVE	SOT-89	PK	3	1000	Green (RoHS & no Sb/Br)	CU SN	Level-2-260C-1YEAR
TLVH432CDBZR	ACTIVE	SOT-23	DBZ	3	3000	Green (RoHS & no Sb/Br)	CU NIPDAU	Level-1-260C-UNLIM
TLVH432CDBZRG4	ACTIVE	SOT-23	DBZ	3	3000	Green (RoHS & no Sb/Br)	CU NIPDAU	Level-1-260C-UNLIM
TLVH432CDBZT	ACTIVE	SOT-23	DBZ	3	250	Green (RoHS & no Sb/Br)	CU NIPDAU	Level-1-260C-UNLIM
TLVH432CDBZTG4	ACTIVE	SOT-23	DBZ	3	250	Green (RoHS & no Sb/Br)	CU NIPDAU	Level-1-260C-UNLIM
TLVH432CPK	ACTIVE	SOT-89	PK	3	1000	Green (RoHS & no Sb/Br)	CU SN	Level-2-260C-1YEAR
TLVH432CPK3	ACTIVE	SOT-89	PK	3	1000	Green (RoHS & no Sb/Br)	CU SN	Level-2-260C-1YEAR

Orderable Device	Status ⁽¹⁾	Package Type	Package Drawing	Pins	Package Qty	Eco Plan ⁽²⁾	Lead/Ball Finish	MSL Peak Temp ⁽³⁾
TLVH432IDBZR	ACTIVE	SOT-23	DBZ	3	3000	Green (RoHS & no Sb/Br)	CU NIPDAU	Level-1-260C-UNLIM
TLVH432IDBZRG4	ACTIVE	SOT-23	DBZ	3	3000	Green (RoHS & no Sb/Br)	CU NIPDAU	Level-1-260C-UNLIM
TLVH432IDBZT	ACTIVE	SOT-23	DBZ	3	250	Green (RoHS & no Sb/Br)	CU NIPDAU	Level-1-260C-UNLIM
TLVH432IDBZTG4	ACTIVE	SOT-23	DBZ	3	250	Green (RoHS & no Sb/Br)	CU NIPDAU	Level-1-260C-UNLIM
TLVH432IPK	ACTIVE	SOT-89	PK	3	1000	Green (RoHS & no Sb/Br)	CU SN	Level-2-260C-1YEAR
TLVH432IPKG3	ACTIVE	SOT-89	PK	3	1000	Green (RoHS & no Sb/Br)	CU SN	Level-2-260C-1YEAR
TLVH432QDBZR	ACTIVE	SOT-23	DBZ	3	3000	Green (RoHS & no Sb/Br)	CU NIPDAU	Level-1-260C-UNLIM
TLVH432QDBZRG4	ACTIVE	SOT-23	DBZ	3	3000	Green (RoHS & no Sb/Br)	CU NIPDAU	Level-1-260C-UNLIM
TLVH432QDBZT	ACTIVE	SOT-23	DBZ	3	250	Green (RoHS & no Sb/Br)	CU NIPDAU	Level-1-260C-UNLIM
TLVH432QDBZTG4	ACTIVE	SOT-23	DBZ	3	250	Green (RoHS & no Sb/Br)	CU NIPDAU	Level-1-260C-UNLIM
TLVH432QPK	ACTIVE	SOT-89	PK	3	1000	Green (RoHS & no Sb/Br)	CU SN	Level-2-260C-1YEAR
TLVH432QPKG3	ACTIVE	SOT-89	PK	3	1000	Green (RoHS & no Sb/Br)	CU SN	Level-2-260C-1YEAR

⁽¹⁾ The marketing status values are defined as follows:

ACTIVE: Product device recommended for new designs.

LIFEBUY: TI has announced that the device will be discontinued, and a lifetime-buy period is in effect.

NRND: Not recommended for new designs. Device is in production to support existing customers, but TI does not recommend using this part in a new design.

PREVIEW: Device has been announced but is not in production. Samples may or may not be available.

OBsolete: TI has discontinued the production of the device.

⁽²⁾ Eco Plan - The planned eco-friendly classification: Pb-Free (RoHS), Pb-Free (RoHS Exempt), or Green (RoHS & no Sb/Br) - please check <http://www.ti.com/productcontent> for the latest availability information and additional product content details.

TBD: The Pb-Free/Green conversion plan has not been defined.

Pb-Free (RoHS): TI's terms "Lead-Free" or "Pb-Free" mean semiconductor products that are compatible with the current RoHS requirements for all 6 substances, including the requirement that lead not exceed 0.1% by weight in homogeneous materials. Where designed to be soldered at high temperatures, TI Pb-Free products are suitable for use in specified lead-free processes.

Pb-Free (RoHS Exempt): This component has a RoHS exemption for either 1) lead-based flip-chip solder bumps used between the die and package, or 2) lead-based die adhesive used between the die and leadframe. The component is otherwise considered Pb-Free (RoHS compatible) as defined above.

Green (RoHS & no Sb/Br): TI defines "Green" to mean Pb-Free (RoHS compatible), and free of Bromine (Br) and Antimony (Sb) based flame retardants (Br or Sb do not exceed 0.1% by weight in homogeneous material)

⁽³⁾ MSL, Peak Temp. -- The Moisture Sensitivity Level rating according to the JEDEC industry standard classifications, and peak solder temperature.

Important Information and Disclaimer: The information provided on this page represents TI's knowledge and belief as of the date that it is provided. TI bases its knowledge and belief on information provided by third parties, and makes no representation or warranty as to the accuracy of such information. Efforts are underway to better integrate information from third parties. TI has taken and continues to take reasonable steps to provide representative and accurate information but may not have conducted destructive testing or chemical analysis on incoming materials and chemicals. TI and TI suppliers consider certain information to be proprietary, and thus CAS numbers and other limited information may not be available for release.

In no event shall TI's liability arising out of such information exceed the total purchase price of the TI part(s) at issue in this document sold by TI

to Customer on an annual basis.

PK (R-PSS0-F3)

PLASTIC SINGLE-IN-LINE PACKAGE

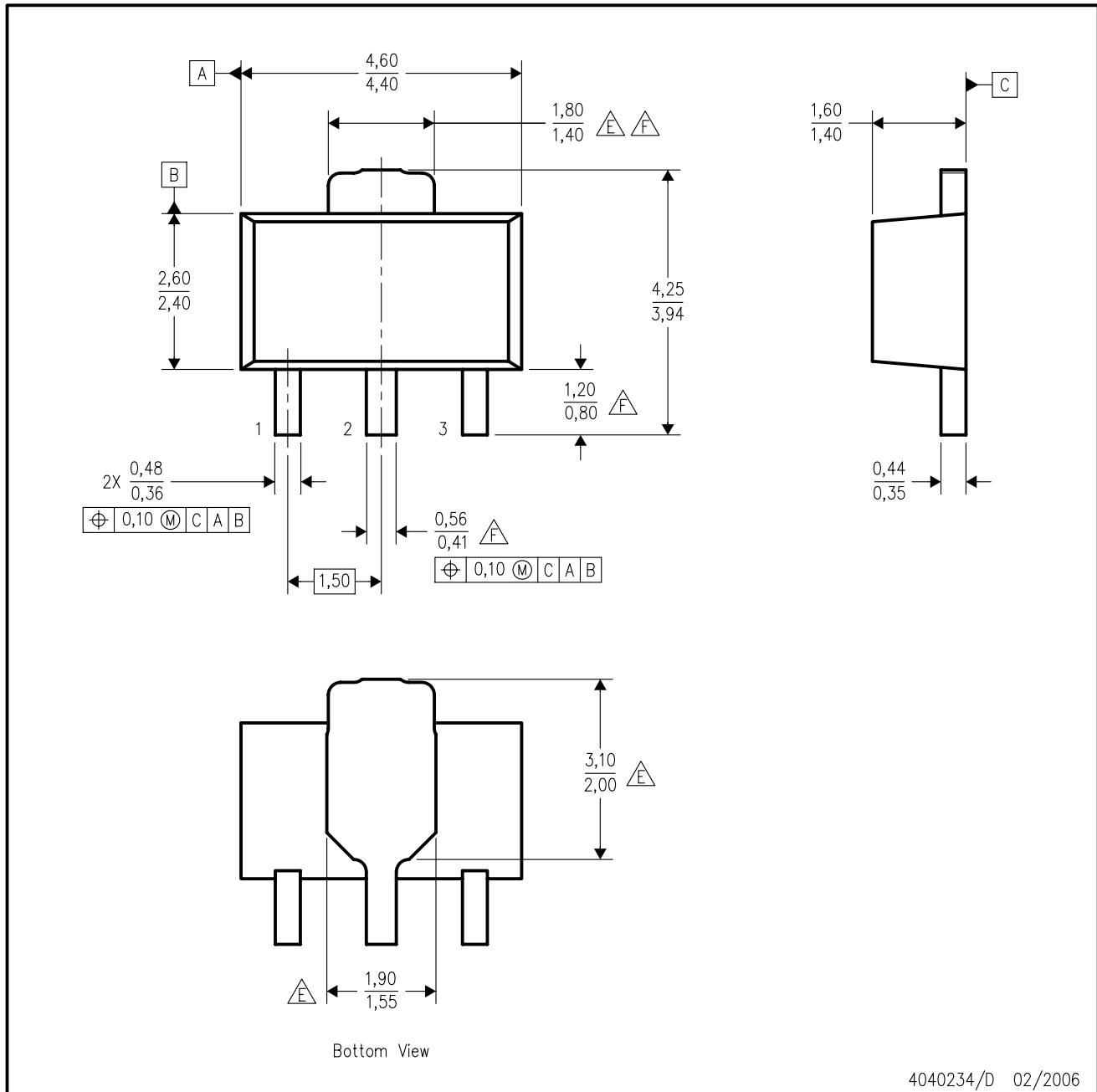

- NOTES:
- All linear dimensions are in millimeters. Dimensioning and tolerancing per ASME Y14.5M-1994.
 - This drawing is subject to change without notice.
 - The center lead is in electrical contact with the tab.
 - Body dimensions do not include mold flash or protrusion. Mold flash and protrusion not to exceed 0.15 per side.
- $\triangle E$ Thermal pad contour optional within these dimensions.
- $\triangle F$ Falls within JEDEC TO-243 variation AA, except minimum lead length, pin 2 minimum lead width, minimum tab width.

PK (R-PDSO-G3)



4208221/A 09/06

- NOTES:
- A. All linear dimensions are in millimeters.
 - B. This drawing is subject to change without notice.
 - C. Publication IPC-7351 is recommended for alternate designs.
 - D. Laser cutting apertures with trapezoidal walls and also rounding corners will offer better paste release. Customers should contact their board assembly site for stencil design recommendations. Refer to IPC-7525.
 - E. Customers should contact their board fabrication site for solder mask tolerances between and around signal pads.

DBV (R-PDSO-G5)

PLASTIC SMALL-OUTLINE PACKAGE



- NOTES:
- A. All linear dimensions are in millimeters.
 - B. This drawing is subject to change without notice.
 - C. Body dimensions do not include mold flash or protrusion. Mold flash and protrusion shall not exceed 0.15 per side.
 - D. Falls within JEDEC MO-178 Variation AA.

DCK (R-PDSO-G6)

PLASTIC SMALL-OUTLINE PACKAGE





- NOTES:
- A. All linear dimensions are in millimeters.
 - B. This drawing is subject to change without notice.
 - C. Body dimensions do not include mold flash or protrusion. Mold flash and protrusion shall not exceed 0.15 per side.
 - D. Falls within JEDEC MO-203 variation AB.

LP (O-PBCY-W3)

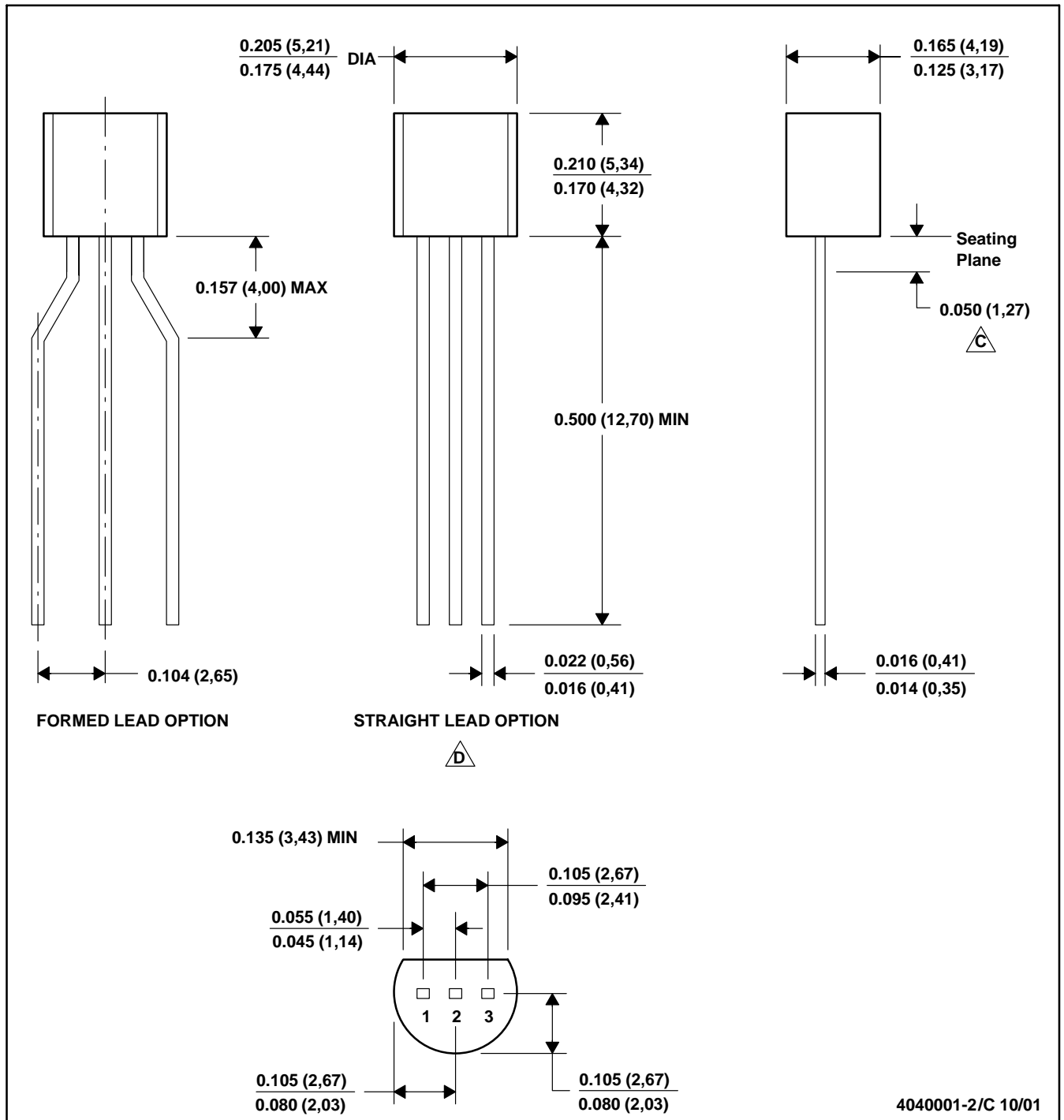
PLASTIC CYLINDRICAL PACKAGE



4040001-2/C 10/01

- NOTES:
- A. All linear dimensions are in inches (millimeters).
 - B. This drawing is subject to change without notice.
 -  C. Lead dimensions are not controlled within this area
 -  D. Falls within JEDEC TO -226 Variation AA (TO-226 replaces TO-92)
 - E. Shipping Method:
 Straight lead option available in bulk pack only.
 Formed lead option available in tape & reel or ammo pack.

MECHANICAL DATA

MSOT002A – OCTOBER 1994 – REVISED NOVEMBER 2001

LP (O-PBCY-W3)

PLASTIC CYLINDRICAL PACKAGE

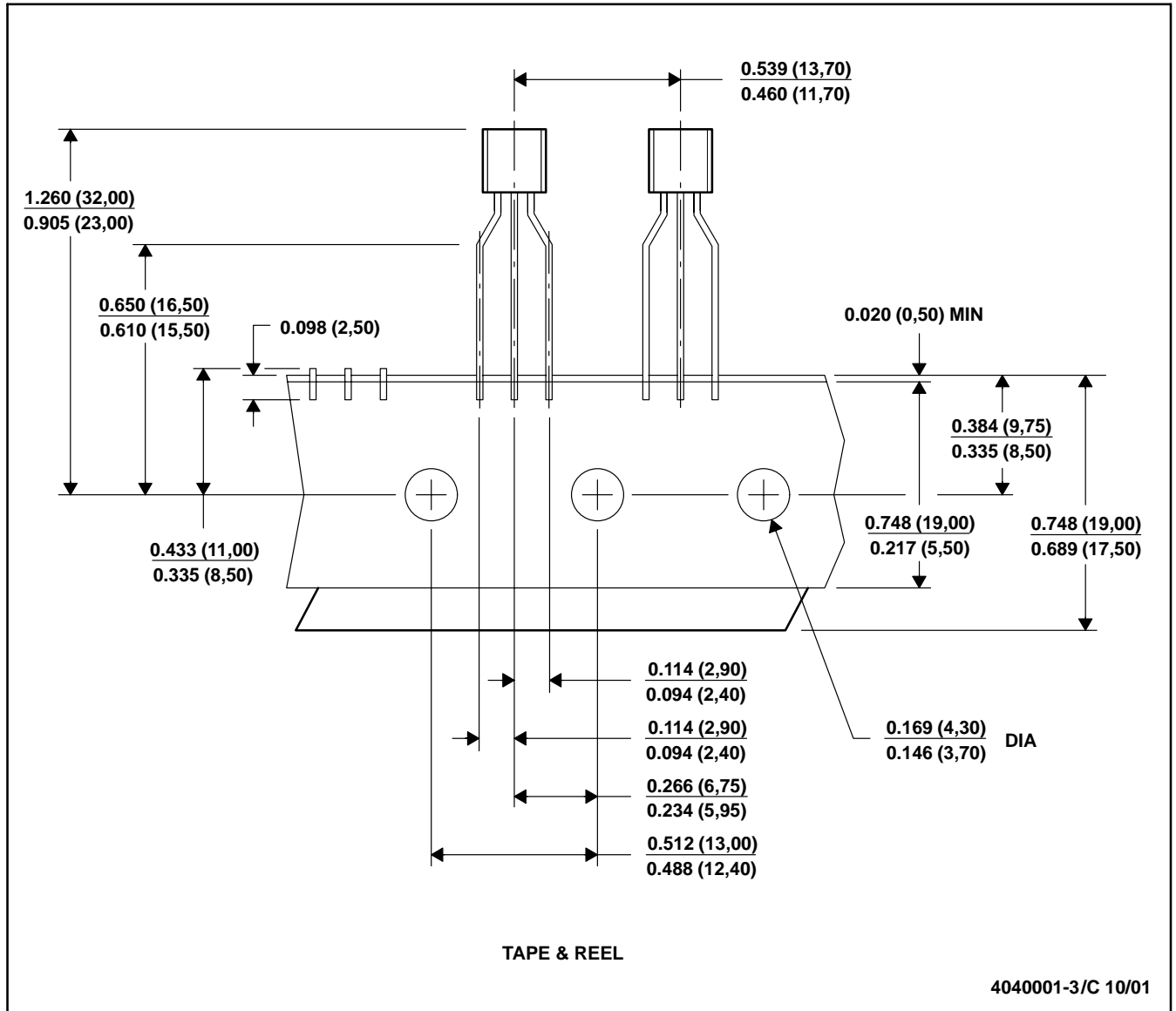

- NOTES: A. All linear dimensions are in inches (millimeters).
 B. This drawing is subject to change without notice.
 C. Tape and Reel information for the Format Lead Option package.

IMPORTANT NOTICE

Texas Instruments Incorporated and its subsidiaries (TI) reserve the right to make corrections, modifications, enhancements, improvements, and other changes to its products and services at any time and to discontinue any product or service without notice. Customers should obtain the latest relevant information before placing orders and should verify that such information is current and complete. All products are sold subject to TI's terms and conditions of sale supplied at the time of order acknowledgment.

TI warrants performance of its hardware products to the specifications applicable at the time of sale in accordance with TI's standard warranty. Testing and other quality control techniques are used to the extent TI deems necessary to support this warranty. Except where mandated by government requirements, testing of all parameters of each product is not necessarily performed.

TI assumes no liability for applications assistance or customer product design. Customers are responsible for their products and applications using TI components. To minimize the risks associated with customer products and applications, customers should provide adequate design and operating safeguards.

TI does not warrant or represent that any license, either express or implied, is granted under any TI patent right, copyright, mask work right, or other TI intellectual property right relating to any combination, machine, or process in which TI products or services are used. Information published by TI regarding third-party products or services does not constitute a license from TI to use such products or services or a warranty or endorsement thereof. Use of such information may require a license from a third party under the patents or other intellectual property of the third party, or a license from TI under the patents or other intellectual property of TI.

Reproduction of information in TI data books or data sheets is permissible only if reproduction is without alteration and is accompanied by all associated warranties, conditions, limitations, and notices. Reproduction of this information with alteration is an unfair and deceptive business practice. TI is not responsible or liable for such altered documentation.

Resale of TI products or services with statements different from or beyond the parameters stated by TI for that product or service voids all express and any implied warranties for the associated TI product or service and is an unfair and deceptive business practice. TI is not responsible or liable for any such statements.

Following are URLs where you can obtain information on other Texas Instruments products and application solutions:

Products

Amplifiers	amplifier.ti.com
Data Converters	dataconverter.ti.com
DSP	dsp.ti.com
Interface	interface.ti.com
Logic	logic.ti.com
Power Mgmt	power.ti.com
Microcontrollers	microcontroller.ti.com
Low Power Wireless	www.ti.com/lpw

Applications

Audio	www.ti.com/audio
Automotive	www.ti.com/automotive
Broadband	www.ti.com/broadband
Digital Control	www.ti.com/digitalcontrol
Military	www.ti.com/military
Optical Networking	www.ti.com/opticalnetwork
Security	www.ti.com/security
Telephony	www.ti.com/telephony
Video & Imaging	www.ti.com/video
Wireless	www.ti.com/wireless

Mailing Address: Texas Instruments
Post Office Box 655303 Dallas, Texas 75265



Стандарт Электрон Связь

Мы молодая и активно развивающаяся компания в области поставок электронных компонентов. Мы поставляем электронные компоненты отечественного и импортного производства напрямую от производителей и с крупнейших складов мира.

Благодаря сотрудничеству с мировыми поставщиками мы осуществляем комплексные и плановые поставки широчайшего спектра электронных компонентов.

Собственная эффективная логистика и склад в обеспечивает надежную поставку продукции в точно указанные сроки по всей России.

Мы осуществляем техническую поддержку нашим клиентам и предпродажную проверку качества продукции. На все поставляемые продукты мы предоставляем гарантию .

Осуществляем поставки продукции под контролем ВП МО РФ на предприятия военно-промышленного комплекса России , а также работаем в рамках 275 ФЗ с открытием отдельных счетов в уполномоченном банке. Система менеджмента качества компании соответствует требованиям ГОСТ ISO 9001.

Минимальные сроки поставки, гибкие цены, неограниченный ассортимент и индивидуальный подход к клиентам являются основой для выстраивания долгосрочного и эффективного сотрудничества с предприятиями радиоэлектронной промышленности, предприятиями ВПК и научно-исследовательскими институтами России.

С нами вы становитесь еще успешнее!

Наши контакты:

Телефон: +7 812 627 14 35

Электронная почта: sales@st-electron.ru

Адрес: 198099, Санкт-Петербург,
Промышленная ул, дом № 19, литера Н,
помещение 100-Н Офис 331