

## CMOS Dual J-K Master-Slave Flip-Flop

High-Voltage Types (20-Volt Rating)

■ CD4027B is a single monolithic chip integrated circuit containing two identical complementary-symmetry J-K master-slave flip-flops. Each flip-flop has provisions for individual J, K, Set, Reset, and Clock input signals. Buffered Q and  $\bar{Q}$  signals are provided as outputs. This input-output arrangement provides for compatible operation with the RCA-CD4013B dual D-type flip-flop.

The CD4027B is useful in performing control, register, and toggle functions. Logic levels present at the J and K inputs along with internal self-steering control the state of each flip-flop; changes in the flip-flop state are synchronous with the positive-going transition of the clock pulse. Set and reset functions are independent of the clock and are initiated when a high level signal is present at either the Set or Reset input.

The CD4027B types are supplied in 16-lead hermetic dual-in-line ceramic packages (F3A suffix), 16-lead dual-in-line plastic packages (E suffix), 16-lead small-outline packages (M, M96, MT, and NSR suffixes), and 16-lead thin shrink small-outline packages (PW and PWR suffixes).

**MAXIMUM RATINGS, Absolute-Maximum Values:**

<b>DC SUPPLY-VOLTAGE RANGE, (<math>V_{DD}</math>)</b>	
Voltages referenced to $V_{SS}$ Terminal	-0.5V to +20V
<b>INPUT VOLTAGE RANGE, ALL INPUTS</b>	
	-0.5V to $V_{DD} + 0.5V$
<b>DC INPUT CURRENT, ANY ONE INPUT</b>	
	$\pm 10\mu A$
<b>POWER DISSIPATION PER PACKAGE (<math>P_D</math>):</b>	
For $T_A = -55^\circ C$ to $+100^\circ C$	500mW
For $T_A = +100^\circ C$ to $+125^\circ C$	Derate Linearly at 12mW/ $^\circ C$ to 200mW
<b>DEVICE DISSIPATION PER OUTPUT TRANSISTOR</b>	
FOR $T_A =$ FULL PACKAGE-TEMPERATURE RANGE (All Package Types)	100mW
<b>OPERATING-TEMPERATURE RANGE (<math>T_A</math>)</b>	
	$-55^\circ C$ to $+125^\circ C$
<b>STORAGE TEMPERATURE RANGE (<math>T_{stg}</math>)</b>	
	$-65^\circ C$ to $+150^\circ C$
<b>LEAD TEMPERATURE (DURING SOLDERING):</b>	
At distance $1/16 \pm 1/32$ inch ( $1.59 \pm 0.79$ mm) from case for 10s max	$+265^\circ C$

**Features:**

- Set-Reset capability
- Static flip-flop operation — retains state indefinitely with clock level either "high" or "low"
- Medium speed operation — 16 MHz (typ.) clock toggle rate at 10 V
- Standardized symmetrical output characteristics
- 100% tested for quiescent current at 20 V
- Maximum input current of  $1\mu A$  at 18 V over full package-temperature range; 100 nA at 18 V and  $25^\circ C$
- Noise margin (over full package-temperature range):
  - 1 V at  $V_{DD} = 5 V$
  - 2 V at  $V_{DD} = 10 V$
  - 2.5 V at  $V_{DD} = 15 V$
- 5-V, 10-V, and 15-V parametric ratings
- Meets all requirements of JEDEC Tentative Standard No. 13B, "Standard Specifications for Description of 'B' Series CMOS Devices"

**Applications:**

- Registers, counters, control circuits

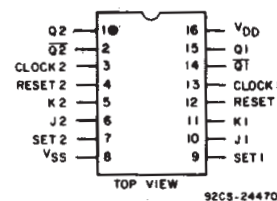
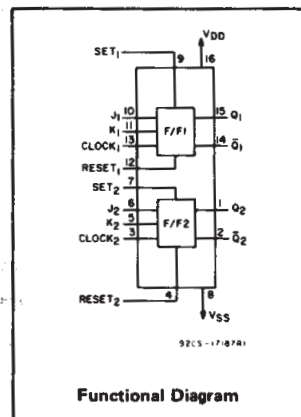

**TERMINAL ASSIGNMENT**

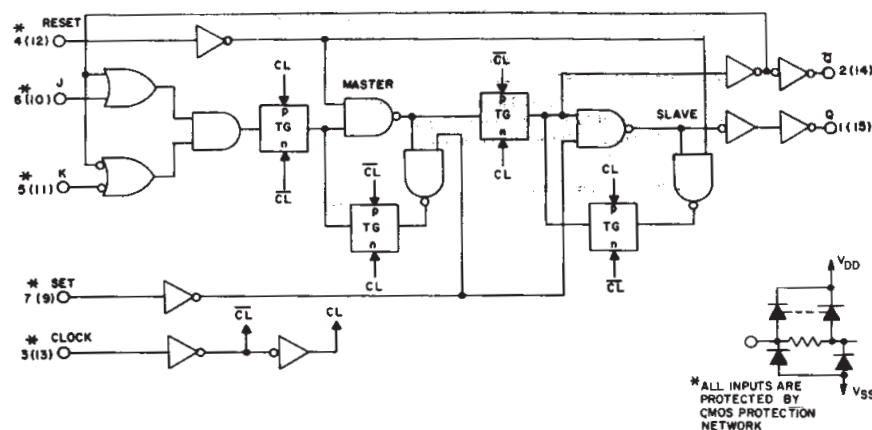

PRESENT STATE					NEXT STATE	
J	K	S	R	Q	Q	CL*
1	x	0	0	0	1	0
x	0	0	0	1	1	0
0	x	0	0	0	0	1
x	1	0	0	1	0	1
x	x	0	0	x	← NO CHANGE	
x	x	1	0	x	1	0
x	x	0	1	x	0	1
x	x	1	1	x	x	1

LOGIC 1 = HIGH LEVEL  
LOGIC 0 = LOW LEVEL  
Δ = LEVEL CHANGE  
X = DON'T CARE

Fig. 1 — Logic diagram and truth table for CD4027B (one of two identical J-K flip flops).

# CD4027B Types

**RECOMMENDED OPERATING CONDITIONS** at  $T_A = 25^\circ\text{C}$ , Except as Noted.  
 For maximum reliability, nominal operating conditions should be selected so that operation is always within the following ranges:

CHARACTERISTIC	$V_{DD}$ (V)	LIMITS		UNITS	
		All Packages			
		Min.	Max.		
Supply-Voltage Range (For $T_A =$ Full Package Temperature Range)	—	3	18	V	
Data Setup Time	$t_S$	5 10 15	200 75 50	— — —	ns
Clock Pulse Width	$t_W$	5 10 15	140 60 40	— — —	ns
Clock Input Frequency (Toggle Mode)	$f_{CL}$	5 10 15	dc 8 12	— — —	MHz
Clock Rise or Fall Time	$t_{rCL}^*$ , $t_{fCL}$	5 10 15	— — —	45 5 2	$\mu\text{s}$
Set or Reset Pulse Width	$t_W$	5 10 15	180 80 50	— — —	ns

\* If more than one unit is cascaded in a parallel clocked operation,  $t_{rCL}$  should be made less than or equal to the sum of the fixed propagation delay time at 15 pF and the transition time of the output driving stage for the estimated capacitive load.

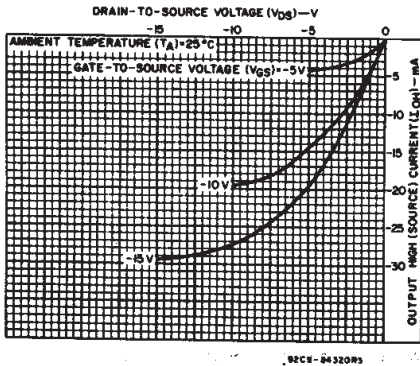

Fig. 4 — Typical output high (source) current characteristics.

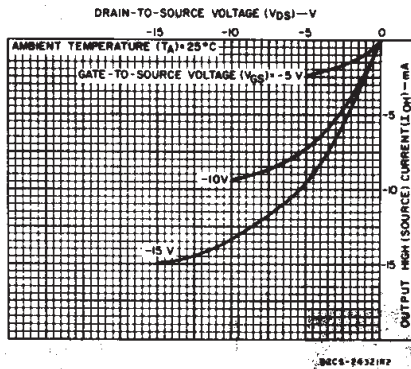

Fig. 5 — Minimum output high (source) current characteristics.

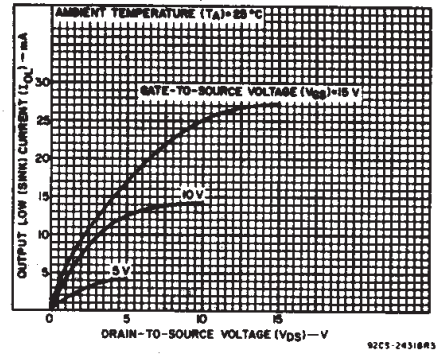

Fig. 2 — Typical output low (sink) current characteristics.

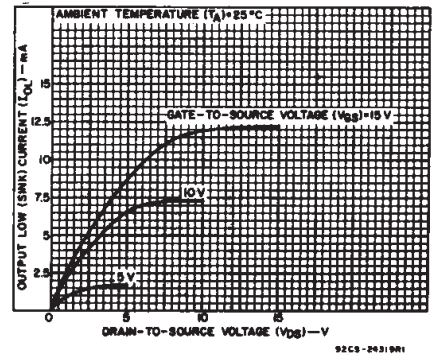

Fig. 3 — Minimum output low (sink) current characteristics.

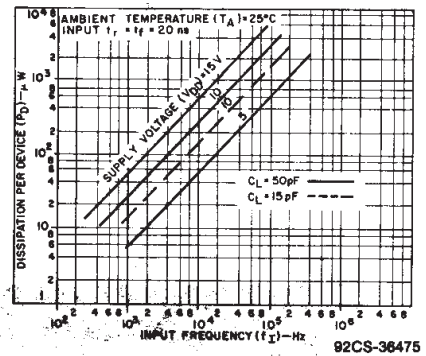

Fig. 6 — Typical power dissipation vs. frequency.

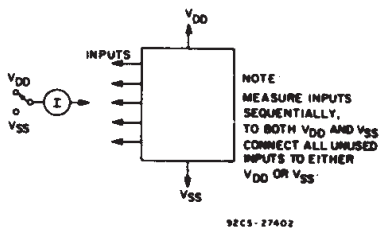

Fig. 7 — Input current test circuit.

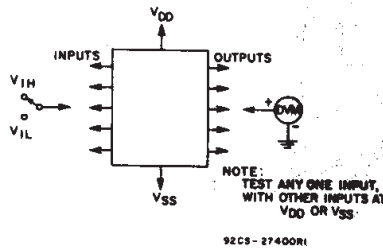

Fig. 8 — Input-voltage test circuit.

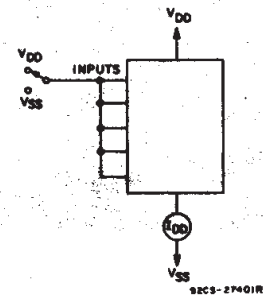

Fig. 9 — Quiescent device current test circuit.

3  
 COMMERCIAL CMOS  
 HIGH VOLTAGE ICs

# CD4027B Types

## STATIC ELECTRICAL CHARACTERISTICS

CHARACTERISTIC	CONDITIONS			LIMITS AT INDICATED TEMPERATURES (°C)							UNITS
	V <sub>O</sub> (V)	V <sub>IN</sub> (V)	V <sub>DD</sub> (V)	-55	-40	+85	+125	+25			
								Min.	Typ.	Max.	
Quiescent Device Current I <sub>DD</sub> Max.	-	0,5	5	1	1	30	30	-	0,02	1	μA
	-	0,10	10	2	2	60	60	-	0,02	2	
	-	0,15	15	4	4	120	120	-	0,02	4	
	-	0,20	20	20	20	600	600	-	0,04	20	
Output Low (Sink) Current, I <sub>OL</sub> Min.	0,4	0,5	5	0,64	0,61	0,42	0,36	0,51	1	-	mA
	0,5	0,10	10	1,6	1,5	1,1	0,9	1,3	2,6	-	
	1,5	0,15	15	4,2	4	2,8	2,4	3,4	6,8	-	
	4,6	0,5	5	-0,64	-0,61	-0,42	-0,36	-0,51	-1	-	
Output High (Source) Current, I <sub>OH</sub> Min.	2,5	0,5	5	-2	-1,8	-1,3	-1,15	-1,6	-3,2	-	mA
	9,5	0,10	10	-1,6	-1,5	-1,1	-0,9	-1,3	-2,6	-	
	13,5	0,15	15	-4,2	-4	-2,8	-2,4	-3,4	-6,8	-	
	4,6	0,5	5	-0,64	-0,61	-0,42	-0,36	-0,51	-1	-	
Output Voltage: Low-Level, V <sub>OL</sub> Max.	-	0,5	5	0,05				-	0	0,05	V
	-	0,10	10	0,05				-	0	0,05	
	-	0,15	15	0,05				-	0	0,05	
Output Voltage: High-Level, V <sub>OH</sub> Min.	-	0,5	5	4,95				4,95	5	-	V
	-	0,10	10	9,95				9,95	10	-	
	-	0,15	15	14,95				14,95	15	-	
Input Low Voltage, V <sub>IL</sub> Max.	0,5,4,5	-	5	1,5				-	-	1,5	V
	1,9	-	10	3				-	-	3	
	1,5,13,5	-	15	4				-	-	4	
Input High Voltage, V <sub>IH</sub> Min.	0,5,4,5	-	5	3,5				3,5	-	-	V
	1,9	-	10	7				7	-	-	
	1,5,13,5	-	15	11				11	-	-	
Input Current, I <sub>IN</sub> Max.	-	0,18	18	±0,1	±0,1	±1	±1	-	±10 <sup>-5</sup>	±0,1	μA

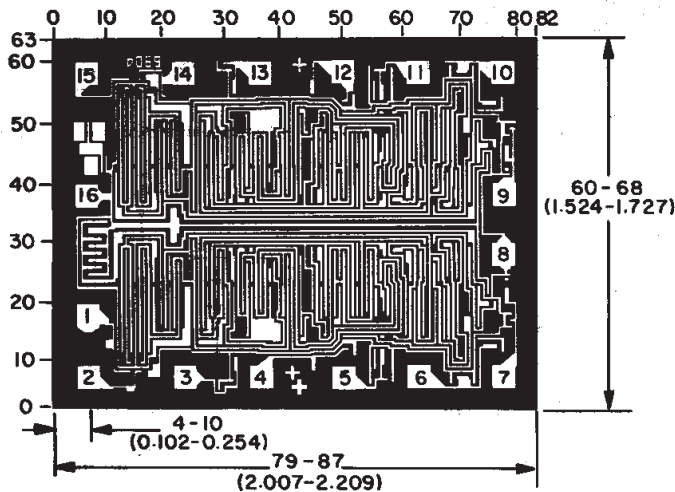

Dimensions in millimeters are derived from the basic inch dimensions as indicated. Grid graduations are in mils (10<sup>-3</sup>).

Dimensions and Pad Layout for CD4027BH

92CS-35059

# CD4027B Types

DYNAMIC ELECTRICAL CHARACTERISTICS at  $T_A = 25^\circ\text{C}$ ; Input  $t_r, t_f = 20 \text{ ns}$ ,  $C_L = 50 \text{ pF}$ ,  $R_L = 200 \text{ k}\Omega$

CHARACTERISTIC	VDD (V)	LIMITS			UNITS
		All Packages			
		Min.	Typ.	Max.	
Propagation Delay Time: Clock to Q or $\bar{Q}$ Outputs $t_{PHL}, t_{PLH}$	5	—	150	300	ns
	10	—	65	130	
	15	—	45	90	
Set to Q or Reset to $\bar{Q}$ $t_{PLH}$	5	—	150	300	ns
	10	—	65	130	
	15	—	45	90	
Set to $\bar{Q}$ or Reset to Q $t_{PHL}$	5	—	200	400	ns
	10	—	85	170	
	15	—	60	120	
Transition Time $t_{THL}, t_{TLH}$	5	—	100	200	ns
	10	—	50	100	
	15	—	40	80	
Maximum Clock Input Frequency# (Toggle Mode) $f_{CL}$	5	3.5	7	—	MHz
	10	8	16	—	
	15	12	24	—	
Minimum Clock Pulse Width $t_W$	5	—	70	140	ns
	10	—	30	60	
	15	—	20	40	
Minimum Set or Reset Pulse Width $t_W$	5	—	90	180	ns
	10	—	40	80	
	15	—	25	50	
Minimum Data Setup Time $t_S$	5	—	100	200	ns
	10	—	35	75	
	15	—	25	50	
Clock Input Rise or Fall Time $t_{rCL}, t_{fCL}$	5	—	—	45	$\mu\text{s}$
	10	—	—	5	
	15	—	—	2	
Input Capacitance $C_i$		—	5	7.5	pF

# Input  $t_r, t_f = 5 \text{ ns}$ .

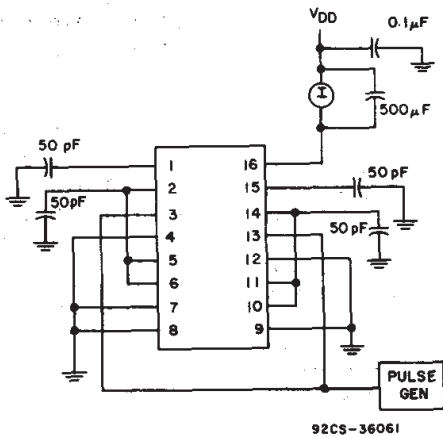

Fig. 13—Dynamic power dissipation test circuit.

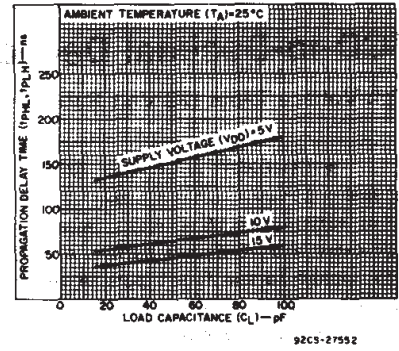

Fig. 10—Typical propagation delay time vs. load capacitance (CLOCK or SET to Q, CLOCK or RESET to  $\bar{Q}$ ).

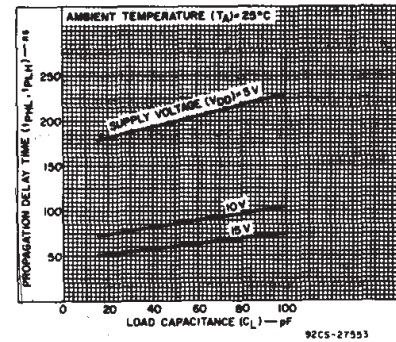

Fig. 11—Typical propagation delay time vs. load capacitance (SET to Q or RESET to Q).

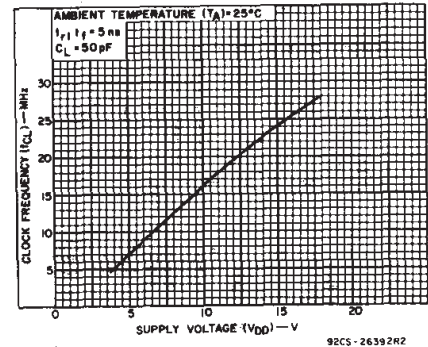

Fig. 12—Typical maximum clock frequency vs. supply voltage (toggle mode).

3  
COMMERCIAL CMOS  
HIGH VOLTAGE ICs

**PACKAGING INFORMATION**

Orderable Device	Status <sup>(1)</sup>	Package Type	Package Drawing	Pins	Package Qty	Eco Plan <sup>(2)</sup>	Lead/Ball Finish	MSL Peak Temp <sup>(3)</sup>
CD4027BE	ACTIVE	PDIP	N	16	25	Pb-Free (RoHS)	CU NIPDAU	N / A for Pkg Type
CD4027BEE4	ACTIVE	PDIP	N	16	25	Pb-Free (RoHS)	CU NIPDAU	N / A for Pkg Type
CD4027BF	ACTIVE	CDIP	J	16	1	TBD	A42	N / A for Pkg Type
CD4027BF3A	ACTIVE	CDIP	J	16	1	TBD	A42	N / A for Pkg Type
CD4027BF3AS2534	OBSOLETE	CDIP	J	16		TBD	Call TI	Call TI
CD4027BM	ACTIVE	SOIC	D	16	40	Green (RoHS & no Sb/Br)	CU NIPDAU	Level-1-260C-UNLIM
CD4027BM96	ACTIVE	SOIC	D	16	2500	Green (RoHS & no Sb/Br)	CU NIPDAU	Level-1-260C-UNLIM
CD4027BM96E4	ACTIVE	SOIC	D	16	2500	Green (RoHS & no Sb/Br)	CU NIPDAU	Level-1-260C-UNLIM
CD4027BM96G4	ACTIVE	SOIC	D	16	2500	Green (RoHS & no Sb/Br)	CU NIPDAU	Level-1-260C-UNLIM
CD4027BME4	ACTIVE	SOIC	D	16	40	Green (RoHS & no Sb/Br)	CU NIPDAU	Level-1-260C-UNLIM
CD4027BMG4	ACTIVE	SOIC	D	16	40	Green (RoHS & no Sb/Br)	CU NIPDAU	Level-1-260C-UNLIM
CD4027BMT	ACTIVE	SOIC	D	16	250	Green (RoHS & no Sb/Br)	CU NIPDAU	Level-1-260C-UNLIM
CD4027BMTE4	ACTIVE	SOIC	D	16	250	Green (RoHS & no Sb/Br)	CU NIPDAU	Level-1-260C-UNLIM
CD4027BMTG4	ACTIVE	SOIC	D	16	250	Green (RoHS & no Sb/Br)	CU NIPDAU	Level-1-260C-UNLIM
CD4027BNSR	ACTIVE	SO	NS	16	2000	Green (RoHS & no Sb/Br)	CU NIPDAU	Level-1-260C-UNLIM
CD4027BNSRE4	ACTIVE	SO	NS	16	2000	Green (RoHS & no Sb/Br)	CU NIPDAU	Level-1-260C-UNLIM
CD4027BNSRG4	ACTIVE	SO	NS	16	2000	Green (RoHS & no Sb/Br)	CU NIPDAU	Level-1-260C-UNLIM
CD4027BPW	ACTIVE	TSSOP	PW	16	90	Green (RoHS & no Sb/Br)	CU NIPDAU	Level-1-260C-UNLIM
CD4027BPWE4	ACTIVE	TSSOP	PW	16	90	Green (RoHS & no Sb/Br)	CU NIPDAU	Level-1-260C-UNLIM
CD4027BPWG4	ACTIVE	TSSOP	PW	16	90	Green (RoHS & no Sb/Br)	CU NIPDAU	Level-1-260C-UNLIM
CD4027BPWR	ACTIVE	TSSOP	PW	16	2000	Green (RoHS & no Sb/Br)	CU NIPDAU	Level-1-260C-UNLIM
CD4027BPWRE4	ACTIVE	TSSOP	PW	16	2000	Green (RoHS & no Sb/Br)	CU NIPDAU	Level-1-260C-UNLIM
CD4027BPWRG4	ACTIVE	TSSOP	PW	16	2000	Green (RoHS & no Sb/Br)	CU NIPDAU	Level-1-260C-UNLIM
JM38510/05152BEA	ACTIVE	CDIP	J	16	1	TBD	A42	N / A for Pkg Type

<sup>(1)</sup> The marketing status values are defined as follows:

**ACTIVE:** Product device recommended for new designs.

**LIFEBUY:** TI has announced that the device will be discontinued, and a lifetime-buy period is in effect.

**NRND:** Not recommended for new designs. Device is in production to support existing customers, but TI does not recommend using this part in a new design.



**PREVIEW:** Device has been announced but is not in production. Samples may or may not be available.

**OBSOLETE:** TI has discontinued the production of the device.

<sup>(2)</sup> Eco Plan - The planned eco-friendly classification: Pb-Free (RoHS), Pb-Free (RoHS Exempt), or Green (RoHS & no Sb/Br) - please check <http://www.ti.com/productcontent> for the latest availability information and additional product content details.

**TBD:** The Pb-Free/Green conversion plan has not been defined.

**Pb-Free (RoHS):** TI's terms "Lead-Free" or "Pb-Free" mean semiconductor products that are compatible with the current RoHS requirements for all 6 substances, including the requirement that lead not exceed 0.1% by weight in homogeneous materials. Where designed to be soldered at high temperatures, TI Pb-Free products are suitable for use in specified lead-free processes.

**Pb-Free (RoHS Exempt):** This component has a RoHS exemption for either 1) lead-based flip-chip solder bumps used between the die and package, or 2) lead-based die adhesive used between the die and leadframe. The component is otherwise considered Pb-Free (RoHS compatible) as defined above.

**Green (RoHS & no Sb/Br):** TI defines "Green" to mean Pb-Free (RoHS compatible), and free of Bromine (Br) and Antimony (Sb) based flame retardants (Br or Sb do not exceed 0.1% by weight in homogeneous material)

<sup>(3)</sup> MSL, Peak Temp. -- The Moisture Sensitivity Level rating according to the JEDEC industry standard classifications, and peak solder temperature.

**Important Information and Disclaimer:**The information provided on this page represents TI's knowledge and belief as of the date that it is provided. TI bases its knowledge and belief on information provided by third parties, and makes no representation or warranty as to the accuracy of such information. Efforts are underway to better integrate information from third parties. TI has taken and continues to take reasonable steps to provide representative and accurate information but may not have conducted destructive testing or chemical analysis on incoming materials and chemicals. TI and TI suppliers consider certain information to be proprietary, and thus CAS numbers and other limited information may not be available for release.

In no event shall TI's liability arising out of such information exceed the total purchase price of the TI part(s) at issue in this document sold by TI to Customer on an annual basis.

**TAPE AND REEL INFORMATION**



**QUADRANT ASSIGNMENTS FOR PIN 1 ORIENTATION IN TAPE**



\*All dimensions are nominal

Device	Package Type	Package Drawing	Pins	SPQ	Reel Diameter (mm)	Reel Width W1 (mm)	A0 (mm)	B0 (mm)	K0 (mm)	P1 (mm)	W (mm)	Pin1 Quadrant
CD4027BM96	SOIC	D	16	2500	330.0	16.4	6.5	10.3	2.1	8.0	16.0	Q1
CD4027BNSR	SO	NS	16	2000	330.0	16.4	8.2	10.5	2.5	12.0	16.0	Q1
CD4027BPWR	TSSOP	PW	16	2000	330.0	12.4	7.0	5.6	1.6	8.0	12.0	Q1

**TAPE AND REEL BOX DIMENSIONS**



\*All dimensions are nominal

Device	Package Type	Package Drawing	Pins	SPQ	Length (mm)	Width (mm)	Height (mm)
CD4027BM96	SOIC	D	16	2500	333.2	345.9	28.6
CD4027BNSR	SO	NS	16	2000	346.0	346.0	33.0
CD4027BPWR	TSSOP	PW	16	2000	346.0	346.0	29.0



PW (R-PDSO-G\*\*)

PLASTIC SMALL-OUTLINE PACKAGE

14 PINS SHOWN



4040064/F 01/97

- NOTES: A. All linear dimensions are in millimeters.  
 B. This drawing is subject to change without notice.  
 C. Body dimensions do not include mold flash or protrusion not to exceed 0,15.  
 D. Falls within JEDEC MO-153

# MECHANICAL DATA

NS (R-PDSO-G\*\*)

PLASTIC SMALL-OUTLINE PACKAGE

14-PINS SHOWN



- NOTES:
- A. All linear dimensions are in millimeters.
  - B. This drawing is subject to change without notice.
  - C. Body dimensions do not include mold flash or protrusion, not to exceed 0,15.

J (R-GDIP-T\*\*)

14 LEADS SHOWN

CERAMIC DUAL IN-LINE PACKAGE



DIM \ PINS **	14	16	18	20
A	0.300 (7,62) BSC	0.300 (7,62) BSC	0.300 (7,62) BSC	0.300 (7,62) BSC
B MAX	0.785 (19,94)	.840 (21,34)	0.960 (24,38)	1.060 (26,92)
B MIN	—	—	—	—
C MAX	0.300 (7,62)	0.300 (7,62)	0.310 (7,87)	0.300 (7,62)
C MIN	0.245 (6,22)	0.245 (6,22)	0.220 (5,59)	0.245 (6,22)



4040083/F 03/03



- NOTES:
- All linear dimensions are in inches (millimeters).
  - This drawing is subject to change without notice.
  - This package is hermetically sealed with a ceramic lid using glass frit.
  - Index point is provided on cap for terminal identification only on press ceramic glass frit seal only.
  - Falls within MIL STD 1835 GDIP1-T14, GDIP1-T16, GDIP1-T18 and GDIP1-T20.

D (R-PDSO-G16)

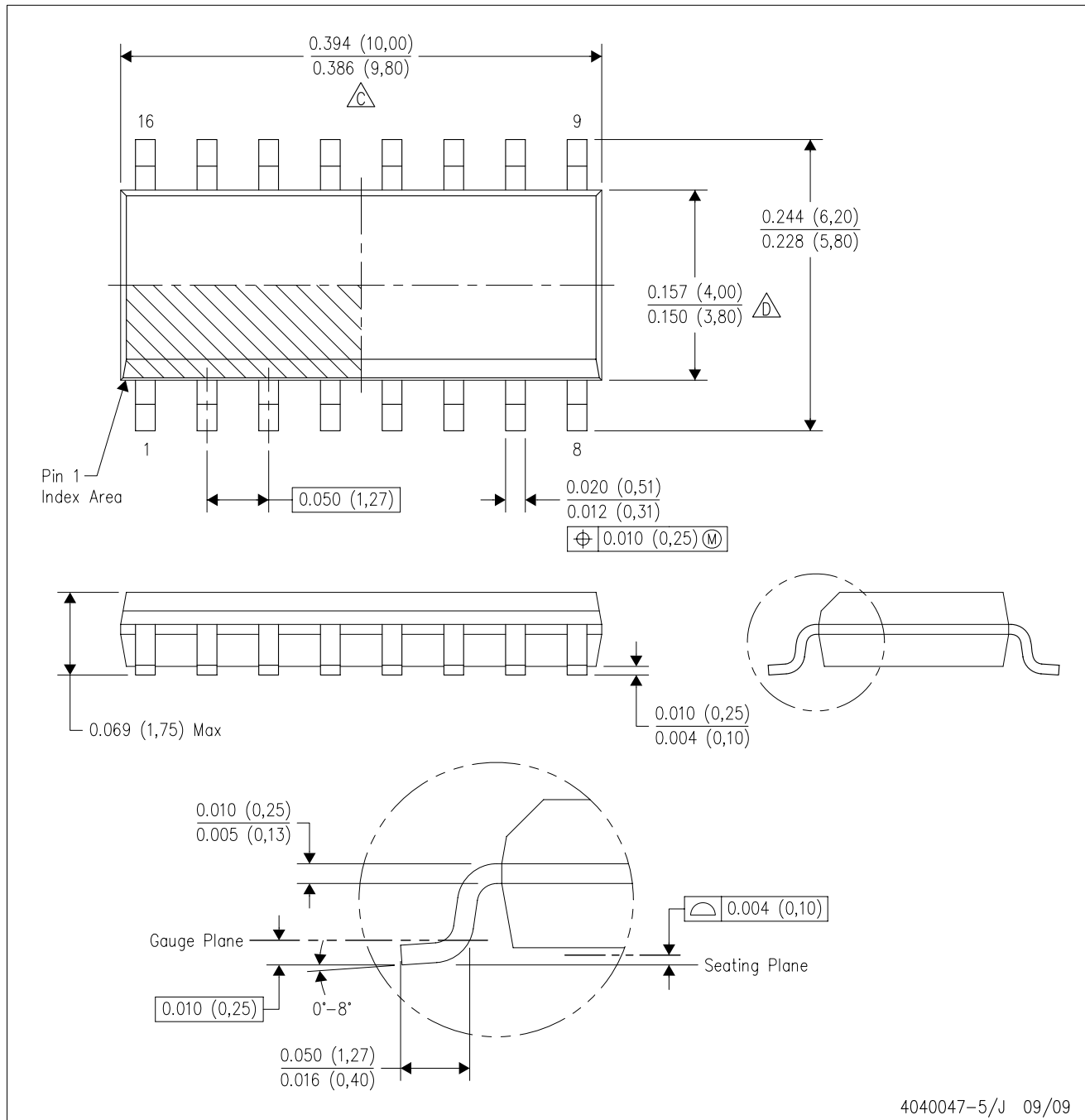
PLASTIC SMALL-OUTLINE PACKAGE



4040047-5/J 09/09

- NOTES:
- A. All linear dimensions are in inches (millimeters).
  - B. This drawing is subject to change without notice.
  -  C. Body length does not include mold flash, protrusions, or gate burrs. Mold flash, protrusions, or gate burrs shall not exceed .006 (0,15) per end.
  -  D. Body width does not include interlead flash. Interlead flash shall not exceed .017 (0,43) per side.
  - E. Reference JEDEC MS-012 variation AC.

D(R-PDSO-G16)

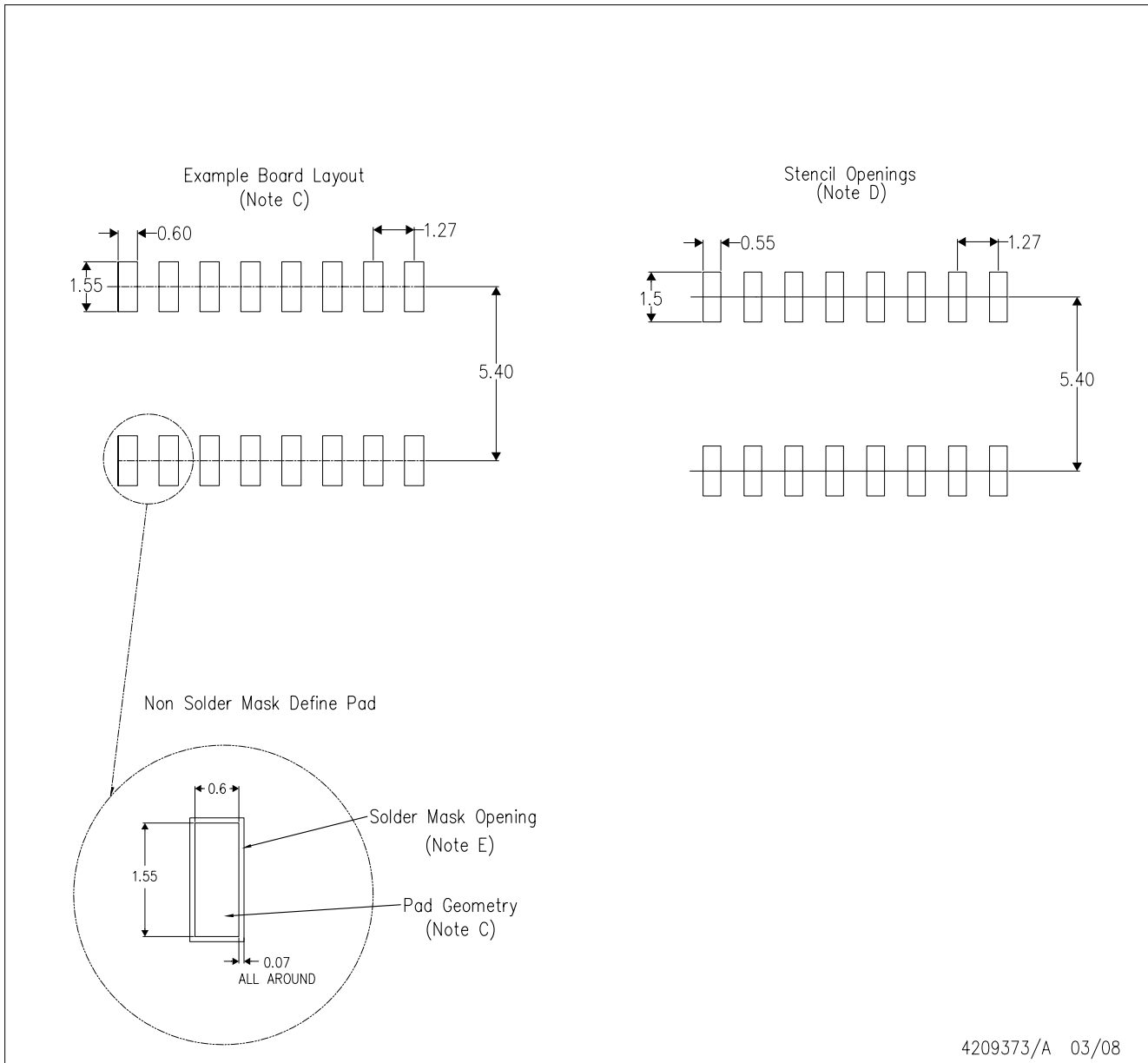

- NOTES:
- A. All linear dimensions are in millimeters.
  - B. This drawing is subject to change without notice.
  - C. Refer to IPC7351 for alternate board design.
  - D. Laser cutting apertures with trapezoidal walls and also rounding corners will offer better paste release. Customers should contact their board assembly site for stencil design recommendations. Refer to IPC-7525
  - E. Customers should contact their board fabrication site for solder mask tolerances between and around signal pads.

N (R-PDIP-T\*\*)

PLASTIC DUAL-IN-LINE PACKAGE

16 PINS SHOWN



- NOTES:
- A. All linear dimensions are in inches (millimeters).
  - B. This drawing is subject to change without notice.
  - Falls within JEDEC MS-001, except 18 and 20 pin minimum body length (Dim A).
  - The 20 pin end lead shoulder width is a vendor option, either half or full width.



**PACKAGING INFORMATION**

Orderable Device	Status <sup>(1)</sup>	Package Type	Package Drawing	Pins	Package Qty	Eco Plan <sup>(2)</sup>	Lead/ Ball Finish	MSL Peak Temp <sup>(3)</sup>	Samples (Requires Login)
CD4027BE	ACTIVE	PDIP	N	16	25	Pb-Free (RoHS)	CU NIPDAU	N / A for Pkg Type	
CD4027BEE4	ACTIVE	PDIP	N	16	25	Pb-Free (RoHS)	CU NIPDAU	N / A for Pkg Type	
CD4027BF	ACTIVE	CDIP	J	16	1	TBD	A42	N / A for Pkg Type	
CD4027BF3A	ACTIVE	CDIP	J	16	1	TBD	A42	N / A for Pkg Type	
CD4027BF3AS2534	OBSOLETE	CDIP	J	16		TBD	Call TI	Call TI	
CD4027BM	ACTIVE	SOIC	D	16	40	Green (RoHS & no Sb/Br)	CU NIPDAU	Level-1-260C-UNLIM	
CD4027BM96	ACTIVE	SOIC	D	16	2500	Green (RoHS & no Sb/Br)	CU NIPDAU	Level-1-260C-UNLIM	
CD4027BM96E4	ACTIVE	SOIC	D	16	2500	Green (RoHS & no Sb/Br)	CU NIPDAU	Level-1-260C-UNLIM	
CD4027BM96G4	ACTIVE	SOIC	D	16	2500	Green (RoHS & no Sb/Br)	CU NIPDAU	Level-1-260C-UNLIM	
CD4027BME4	ACTIVE	SOIC	D	16	40	Green (RoHS & no Sb/Br)	CU NIPDAU	Level-1-260C-UNLIM	
CD4027BMG4	ACTIVE	SOIC	D	16	40	Green (RoHS & no Sb/Br)	CU NIPDAU	Level-1-260C-UNLIM	
CD4027BMT	ACTIVE	SOIC	D	16	250	Green (RoHS & no Sb/Br)	CU NIPDAU	Level-1-260C-UNLIM	
CD4027BMTE4	ACTIVE	SOIC	D	16	250	Green (RoHS & no Sb/Br)	CU NIPDAU	Level-1-260C-UNLIM	
CD4027BMTG4	ACTIVE	SOIC	D	16	250	Green (RoHS & no Sb/Br)	CU NIPDAU	Level-1-260C-UNLIM	
CD4027BNSR	ACTIVE	SO	NS	16	2000	Green (RoHS & no Sb/Br)	CU NIPDAU	Level-1-260C-UNLIM	
CD4027BNSRE4	ACTIVE	SO	NS	16	2000	Green (RoHS & no Sb/Br)	CU NIPDAU	Level-1-260C-UNLIM	
CD4027BNSRG4	ACTIVE	SO	NS	16	2000	Green (RoHS & no Sb/Br)	CU NIPDAU	Level-1-260C-UNLIM	
CD4027BPW	ACTIVE	TSSOP	PW	16	90	Green (RoHS & no Sb/Br)	CU NIPDAU	Level-1-260C-UNLIM	
CD4027BPWE4	ACTIVE	TSSOP	PW	16	90	Green (RoHS & no Sb/Br)	CU NIPDAU	Level-1-260C-UNLIM	

Orderable Device	Status <sup>(1)</sup>	Package Type	Package Drawing	Pins	Package Qty	Eco Plan <sup>(2)</sup>	Lead/ Ball Finish	MSL Peak Temp <sup>(3)</sup>	Samples (Requires Login)
CD4027BPWG4	ACTIVE	TSSOP	PW	16	90	Green (RoHS & no Sb/Br)	CU NIPDAU	Level-1-260C-UNLIM	
CD4027BPWR	ACTIVE	TSSOP	PW	16	2000	Green (RoHS & no Sb/Br)	CU NIPDAU	Level-1-260C-UNLIM	
CD4027BPWRE4	ACTIVE	TSSOP	PW	16	2000	Green (RoHS & no Sb/Br)	CU NIPDAU	Level-1-260C-UNLIM	
CD4027BPWRG4	ACTIVE	TSSOP	PW	16	2000	Green (RoHS & no Sb/Br)	CU NIPDAU	Level-1-260C-UNLIM	
JM38510/05152BEA	ACTIVE	CDIP	J	16	1	TBD	A42	N / A for Pkg Type	
M38510/05152BEA	ACTIVE	CDIP	J	16	1	TBD	A42	N / A for Pkg Type	

<sup>(1)</sup> The marketing status values are defined as follows:

**ACTIVE:** Product device recommended for new designs.

**LIFEBUY:** TI has announced that the device will be discontinued, and a lifetime-buy period is in effect.

**NRND:** Not recommended for new designs. Device is in production to support existing customers, but TI does not recommend using this part in a new design.

**PREVIEW:** Device has been announced but is not in production. Samples may or may not be available.

**OBSELETE:** TI has discontinued the production of the device.

<sup>(2)</sup> Eco Plan - The planned eco-friendly classification: Pb-Free (RoHS), Pb-Free (RoHS Exempt), or Green (RoHS & no Sb/Br) - please check <http://www.ti.com/productcontent> for the latest availability information and additional product content details.

**TBD:** The Pb-Free/Green conversion plan has not been defined.

**Pb-Free (RoHS):** TI's terms "Lead-Free" or "Pb-Free" mean semiconductor products that are compatible with the current RoHS requirements for all 6 substances, including the requirement that lead not exceed 0.1% by weight in homogeneous materials. Where designed to be soldered at high temperatures, TI Pb-Free products are suitable for use in specified lead-free processes.

**Pb-Free (RoHS Exempt):** This component has a RoHS exemption for either 1) lead-based flip-chip solder bumps used between the die and package, or 2) lead-based die adhesive used between the die and leadframe. The component is otherwise considered Pb-Free (RoHS compatible) as defined above.

**Green (RoHS & no Sb/Br):** TI defines "Green" to mean Pb-Free (RoHS compatible), and free of Bromine (Br) and Antimony (Sb) based flame retardants (Br or Sb do not exceed 0.1% by weight in homogeneous material)

<sup>(3)</sup> MSL, Peak Temp. -- The Moisture Sensitivity Level rating according to the JEDEC industry standard classifications, and peak solder temperature.

**Important Information and Disclaimer:** The information provided on this page represents TI's knowledge and belief as of the date that it is provided. TI bases its knowledge and belief on information provided by third parties, and makes no representation or warranty as to the accuracy of such information. Efforts are underway to better integrate information from third parties. TI has taken and continues to take reasonable steps to provide representative and accurate information but may not have conducted destructive testing or chemical analysis on incoming materials and chemicals. TI and TI suppliers consider certain information to be proprietary, and thus CAS numbers and other limited information may not be available for release.

In no event shall TI's liability arising out of such information exceed the total purchase price of the TI part(s) at issue in this document sold by TI to Customer on an annual basis.

**OTHER QUALIFIED VERSIONS OF CD4027B, CD4027B-MIL :**

- Catalog: [CD4027B](#)
- Military: [CD4027B-MIL](#)

NOTE: Qualified Version Definitions:

- Catalog - TI's standard catalog product
- Military - QML certified for Military and Defense Applications

**TAPE AND REEL INFORMATION**
**REEL DIMENSIONS**

**TAPE DIMENSIONS**

A0	Dimension designed to accommodate the component width
B0	Dimension designed to accommodate the component length
K0	Dimension designed to accommodate the component thickness
W	Overall width of the carrier tape
P1	Pitch between successive cavity centers

**TAPE AND REEL INFORMATION**

\*All dimensions are nominal

Device	Package Type	Package Drawing	Pins	SPQ	Reel Diameter (mm)	Reel Width W1 (mm)	A0 (mm)	B0 (mm)	K0 (mm)	P1 (mm)	W (mm)	Pin1 Quadrant
CD4027BM96	SOIC	D	16	2500	330.0	16.4	6.5	10.3	2.1	8.0	16.0	Q1
CD4027BNSR	SO	NS	16	2000	330.0	16.4	8.2	10.5	2.5	12.0	16.0	Q1
CD4027BPWR	TSSOP	PW	16	2000	330.0	12.4	6.9	5.6	1.6	8.0	12.0	Q1

**TAPE AND REEL BOX DIMENSIONS**

\*All dimensions are nominal

Device	Package Type	Package Drawing	Pins	SPQ	Length (mm)	Width (mm)	Height (mm)
CD4027BM96	SOIC	D	16	2500	333.2	345.9	28.6
CD4027BNSR	SO	NS	16	2000	367.0	367.0	38.0
CD4027BPWR	TSSOP	PW	16	2000	367.0	367.0	35.0

J (R-GDIP-T\*\*)

14 LEADS SHOWN

CERAMIC DUAL IN-LINE PACKAGE



DIM \ PINS **	14	16	18	20
A	0.300 (7,62) BSC	0.300 (7,62) BSC	0.300 (7,62) BSC	0.300 (7,62) BSC
B MAX	0.785 (19,94)	.840 (21,34)	0.960 (24,38)	1.060 (26,92)
B MIN	—	—	—	—
C MAX	0.300 (7,62)	0.300 (7,62)	0.310 (7,87)	0.300 (7,62)
C MIN	0.245 (6,22)	0.245 (6,22)	0.220 (5,59)	0.245 (6,22)



4040083/F 03/03

- NOTES:
- All linear dimensions are in inches (millimeters).
  - This drawing is subject to change without notice.
  - This package is hermetically sealed with a ceramic lid using glass frit.
  - Index point is provided on cap for terminal identification only on press ceramic glass frit seal only.
  - Falls within MIL STD 1835 GDIP1-T14, GDIP1-T16, GDIP1-T18 and GDIP1-T20.



N (R-PDIP-T\*\*)

PLASTIC DUAL-IN-LINE PACKAGE

16 PINS SHOWN



- NOTES:
- A. All linear dimensions are in inches (millimeters).
  - B. This drawing is subject to change without notice.
  - Falls within JEDEC MS-001, except 18 and 20 pin minimum body length (Dim A).
  - The 20 pin end lead shoulder width is a vendor option, either half or full width.

D (R-PDSO-G16)

PLASTIC SMALL OUTLINE



- NOTES:
- A. All linear dimensions are in inches (millimeters).
  - B. This drawing is subject to change without notice.
  - C. Body length does not include mold flash, protrusions, or gate burrs. Mold flash, protrusions, or gate burrs shall not exceed 0.006 (0,15) each side.
  - D. Body width does not include interlead flash. Interlead flash shall not exceed 0.017 (0,43) each side.
  - E. Reference JEDEC MS-012 variation AC.

D (R-PDSO-G16)

PLASTIC SMALL OUTLINE



- NOTES:
- A. All linear dimensions are in millimeters.
  - B. This drawing is subject to change without notice.
  - C. Publication IPC-7351 is recommended for alternate designs.
  - D. Laser cutting apertures with trapezoidal walls and also rounding corners will offer better paste release. Customers should contact their board assembly site for stencil design recommendations. Refer to IPC-7525 for other stencil recommendations.
  - E. Customers should contact their board fabrication site for solder mask tolerances between and around signal pads.

PW (R-PDSO-G16)

PLASTIC SMALL OUTLINE



- NOTES:
- A. All linear dimensions are in millimeters. Dimensioning and tolerancing per ASME Y14.5M-1994.
  - B. This drawing is subject to change without notice.
  - C. Body length does not include mold flash, protrusions, or gate burrs. Mold flash, protrusions, or gate burrs shall not exceed 0,15 each side.
  - D. Body width does not include interlead flash. Interlead flash shall not exceed 0,25 each side.
  - E. Falls within JEDEC MO-153

PW (R-PDSO-G16)

PLASTIC SMALL OUTLINE

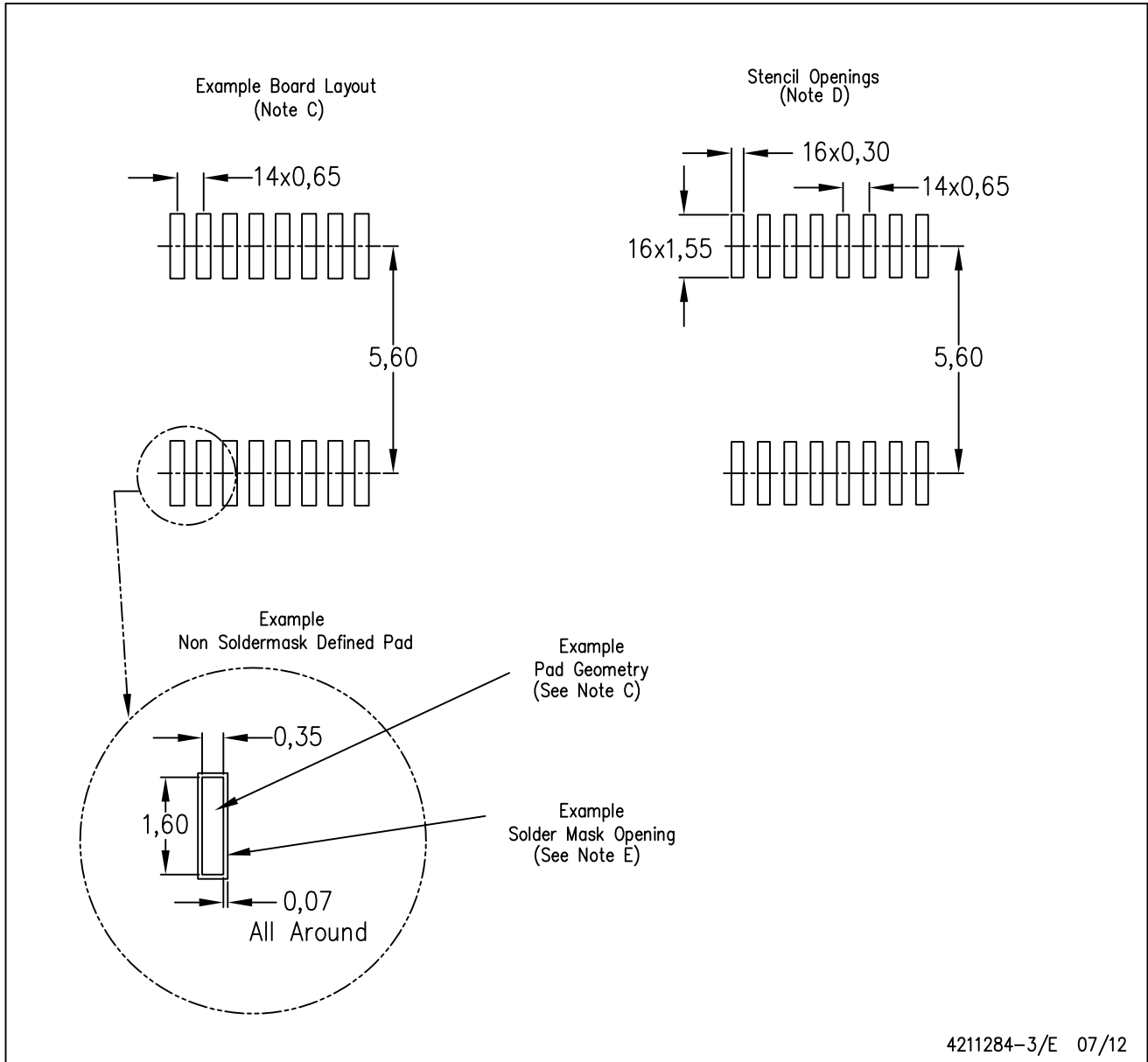

- NOTES:
- All linear dimensions are in millimeters.
  - This drawing is subject to change without notice.
  - Publication IPC-7351 is recommended for alternate designs.
  - Laser cutting apertures with trapezoidal walls and also rounding corners will offer better paste release. Customers should contact their board assembly site for stencil design recommendations. Refer to IPC-7525 for other stencil recommendations.
  - Customers should contact their board fabrication site for solder mask tolerances between and around signal pads.

# MECHANICAL DATA

NS (R-PDSO-G\*\*)

PLASTIC SMALL-OUTLINE PACKAGE

14-PINS SHOWN



- NOTES:
- A. All linear dimensions are in millimeters.
  - B. This drawing is subject to change without notice.
  - C. Body dimensions do not include mold flash or protrusion, not to exceed 0,15.



## IMPORTANT NOTICE

Texas Instruments Incorporated and its subsidiaries (TI) reserve the right to make corrections, enhancements, improvements and other changes to its semiconductor products and services per JESD46C and to discontinue any product or service per JESD48B. Buyers should obtain the latest relevant information before placing orders and should verify that such information is current and complete. All semiconductor products (also referred to herein as "components") are sold subject to TI's terms and conditions of sale supplied at the time of order acknowledgment.

TI warrants performance of its components to the specifications applicable at the time of sale, in accordance with the warranty in TI's terms and conditions of sale of semiconductor products. Testing and other quality control techniques are used to the extent TI deems necessary to support this warranty. Except where mandated by applicable law, testing of all parameters of each component is not necessarily performed.

TI assumes no liability for applications assistance or the design of Buyers' products. Buyers are responsible for their products and applications using TI components. To minimize the risks associated with Buyers' products and applications, Buyers should provide adequate design and operating safeguards.

TI does not warrant or represent that any license, either express or implied, is granted under any patent right, copyright, mask work right, or other intellectual property right relating to any combination, machine, or process in which TI components or services are used. Information published by TI regarding third-party products or services does not constitute a license to use such products or services or a warranty or endorsement thereof. Use of such information may require a license from a third party under the patents or other intellectual property of the third party, or a license from TI under the patents or other intellectual property of TI.

Reproduction of significant portions of TI information in TI data books or data sheets is permissible only if reproduction is without alteration and is accompanied by all associated warranties, conditions, limitations, and notices. TI is not responsible or liable for such altered documentation. Information of third parties may be subject to additional restrictions.

Resale of TI components or services with statements different from or beyond the parameters stated by TI for that component or service voids all express and any implied warranties for the associated TI component or service and is an unfair and deceptive business practice. TI is not responsible or liable for any such statements.

Buyer acknowledges and agrees that it is solely responsible for compliance with all legal, regulatory and safety-related requirements concerning its products, and any use of TI components in its applications, notwithstanding any applications-related information or support that may be provided by TI. Buyer represents and agrees that it has all the necessary expertise to create and implement safeguards which anticipate dangerous consequences of failures, monitor failures and their consequences, lessen the likelihood of failures that might cause harm and take appropriate remedial actions. Buyer will fully indemnify TI and its representatives against any damages arising out of the use of any TI components in safety-critical applications.

In some cases, TI components may be promoted specifically to facilitate safety-related applications. With such components, TI's goal is to help enable customers to design and create their own end-product solutions that meet applicable functional safety standards and requirements. Nonetheless, such components are subject to these terms.

No TI components are authorized for use in FDA Class III (or similar life-critical medical equipment) unless authorized officers of the parties have executed a special agreement specifically governing such use.

Only those TI components which TI has specifically designated as military grade or "enhanced plastic" are designed and intended for use in military/aerospace applications or environments. Buyer acknowledges and agrees that any military or aerospace use of TI components which have **not** been so designated is solely at the Buyer's risk, and that Buyer is solely responsible for compliance with all legal and regulatory requirements in connection with such use.

TI has specifically designated certain components which meet ISO/TS16949 requirements, mainly for automotive use. Components which have not been so designated are neither designed nor intended for automotive use; and TI will not be responsible for any failure of such components to meet such requirements.

### Products

Audio	<a href="http://www.ti.com/audio">www.ti.com/audio</a>
Amplifiers	<a href="http://amplifier.ti.com">amplifier.ti.com</a>
Data Converters	<a href="http://dataconverter.ti.com">dataconverter.ti.com</a>
DLP® Products	<a href="http://www.dlp.com">www.dlp.com</a>
DSP	<a href="http://dsp.ti.com">dsp.ti.com</a>
Clocks and Timers	<a href="http://www.ti.com/clocks">www.ti.com/clocks</a>
Interface	<a href="http://interface.ti.com">interface.ti.com</a>
Logic	<a href="http://logic.ti.com">logic.ti.com</a>
Power Mgmt	<a href="http://power.ti.com">power.ti.com</a>
Microcontrollers	<a href="http://microcontroller.ti.com">microcontroller.ti.com</a>
RFID	<a href="http://www.ti-rfid.com">www.ti-rfid.com</a>
OMAP Mobile Processors	<a href="http://www.ti.com/omap">www.ti.com/omap</a>
Wireless Connectivity	<a href="http://www.ti.com/wirelessconnectivity">www.ti.com/wirelessconnectivity</a>

### Applications

Automotive and Transportation	<a href="http://www.ti.com/automotive">www.ti.com/automotive</a>
Communications and Telecom	<a href="http://www.ti.com/communications">www.ti.com/communications</a>
Computers and Peripherals	<a href="http://www.ti.com/computers">www.ti.com/computers</a>
Consumer Electronics	<a href="http://www.ti.com/consumer-apps">www.ti.com/consumer-apps</a>
Energy and Lighting	<a href="http://www.ti.com/energy">www.ti.com/energy</a>
Industrial	<a href="http://www.ti.com/industrial">www.ti.com/industrial</a>
Medical	<a href="http://www.ti.com/medical">www.ti.com/medical</a>
Security	<a href="http://www.ti.com/security">www.ti.com/security</a>
Space, Avionics and Defense	<a href="http://www.ti.com/space-avionics-defense">www.ti.com/space-avionics-defense</a>
Video and Imaging	<a href="http://www.ti.com/video">www.ti.com/video</a>

**TI E2E Community** [e2e.ti.com](http://e2e.ti.com)



## Стандарт Электрон Связь

Мы молодая и активно развивающаяся компания в области поставок электронных компонентов. Мы поставляем электронные компоненты отечественного и импортного производства напрямую от производителей и с крупнейших складов мира.

Благодаря сотрудничеству с мировыми поставщиками мы осуществляем комплексные и плановые поставки широчайшего спектра электронных компонентов.

Собственная эффективная логистика и склад в обеспечивает надежную поставку продукции в точно указанные сроки по всей России.

Мы осуществляем техническую поддержку нашим клиентам и предпродажную проверку качества продукции. На все поставляемые продукты мы предоставляем гарантию .

Осуществляем поставки продукции под контролем ВП МО РФ на предприятия военно-промышленного комплекса России , а также работаем в рамках 275 ФЗ с открытием отдельных счетов в уполномоченном банке. Система менеджмента качества компании соответствует требованиям ГОСТ ISO 9001.

Минимальные сроки поставки, гибкие цены, неограниченный ассортимент и индивидуальный подход к клиентам являются основой для выстраивания долгосрочного и эффективного сотрудничества с предприятиями радиоэлектронной промышленности, предприятиями ВПК и научно-исследовательскими институтами России.

С нами вы становитесь еще успешнее!

### Наши контакты:

**Телефон:** +7 812 627 14 35

**Электронная почта:** [sales@st-electron.ru](mailto:sales@st-electron.ru)

**Адрес:** 198099, Санкт-Петербург,  
Промышленная ул, дом № 19, литера Н,  
помещение 100-Н Офис 331