

PTVA030121EA

Thermally-Enhanced High Power RF LDMOS FET 12 W, 50 V, 390 – 450 MHz

Description

The PTVA030121EA is an LDMOS FET characterized for use in power amplifier applications in the 390 MHz to 450 MHz frequency band. Features include high gain and a thermally-enhanced package. Manufactured with Wolfspeed's advanced LDMOS process, this device provides excellent thermal performance and superior reliability.



PTVA030121EA
Package H-36265-2

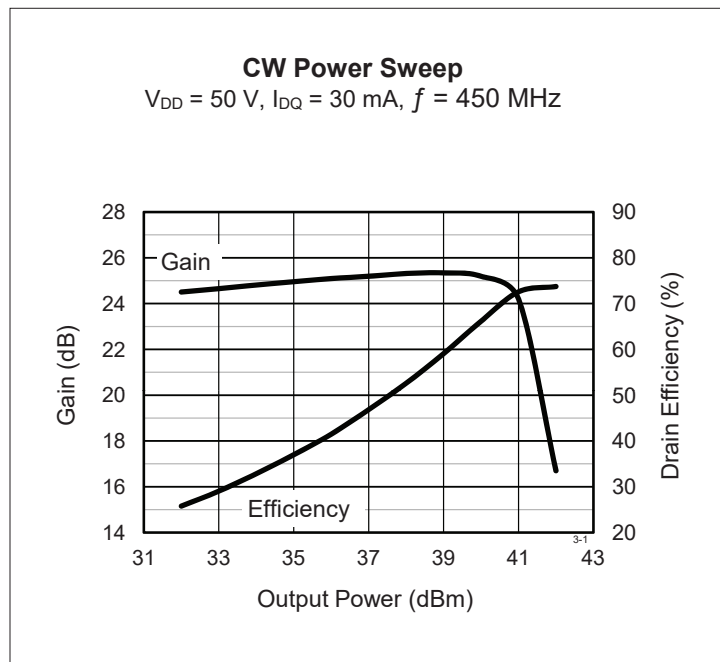

Features

- Unmatched input and output
- Integrated ESD protection
- Human Body Model Class 1C (per ANSI/ESDA/ JEDEC JS-001)
- High gain, low thermal resistance
- Excellent ruggedness
- Capable of withstanding a 13:1 load mismatch at 50 V, 12 W, CW conditions
- Pb-free and RoHS compliant

RF Characteristics

CW Measurements

$V_{DD} = 50\text{ V}$, $I_{DQ} = 50\text{ mA}$, $P_{OUT} = 12\text{ W}$, $f = 450\text{ MHz}$

Characteristic	Symbol	Min	Typ	Max	Unit
Gain	Gps	23	25	—	dB
Drain Efficiency	η_D	66	69	—	%

All published data at $T_{CASE} = 25^\circ\text{C}$ unless otherwise indicated

ESD: Electrostatic discharge sensitive device—observe handling precautions!

DC Characteristics

Characteristic	Conditions	Symbol	Min	Typ	Max	Unit
Drain-Source Breakdown Voltage	$V_{GS} = 0\text{ V}, I_{DS} = 1\text{ mA}$	$V_{(BR)DSS}$	105	—	—	V
Drain Leakage Current	$V_{DS} = 50\text{ V}, V_{GS} = 0\text{ V}$	I_{DSS}	—	—	1.0	μA
	$V_{DS} = 105\text{ V}, V_{GS} = 0\text{ V}$	I_{DSS}	—	—	10.0	μA
On-State Resistance	$V_{GS} = 10\text{ V}, V_{DS} = 0.1\text{ V}$	$R_{DS(on)}$	—	2.8	—	Ω
Operating Gate Voltage	$V_{DS} = 50\text{ V}, I_{DQ} = 50\text{ mA}$	V_{GS}	—	3.6	—	V
Gate Leakage Current	$V_{GS} = 10\text{ V}, V_{DS} = 0\text{ V}$	I_{GSS}	—	—	1.0	μA

Maximum Ratings

Parameter	Symbol	Value	Unit
Drain-Source Voltage	V_{DSS}	105	V
Gate-Source Voltage	V_{GS}	-6 to +12	V
Operating Voltage	V_{DD}	0 to +55	V
Junction Temperature	T_J	225	$^{\circ}\text{C}$
Storage Temperature Range	T_{STG}	-65 to +150	$^{\circ}\text{C}$
Thermal Resistance ($T_{CASE} 70^{\circ}\text{C}, 12\text{ W CW}$)	$R_{\theta JC}$	6.5	$^{\circ}\text{C/W}$

Ordering Information

Type and Version	Order Code	Package and Description	Shipping
PTVA030121EA V1 R0	PTVA030121EA-V1-R0	H-36265-2, bolt-down	Tape & Reel, 50pcs
PTVA030121EA V1 R250	PTVA030121EA-V1-R250	H-36265-2, bolt-down	Tape & Reel, 250pcs

Typical Performance (data taken in a production test circuit)

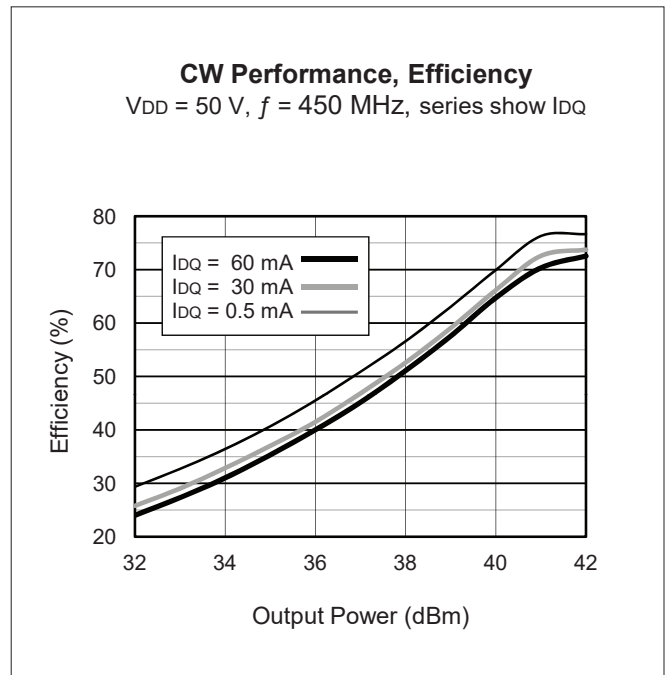
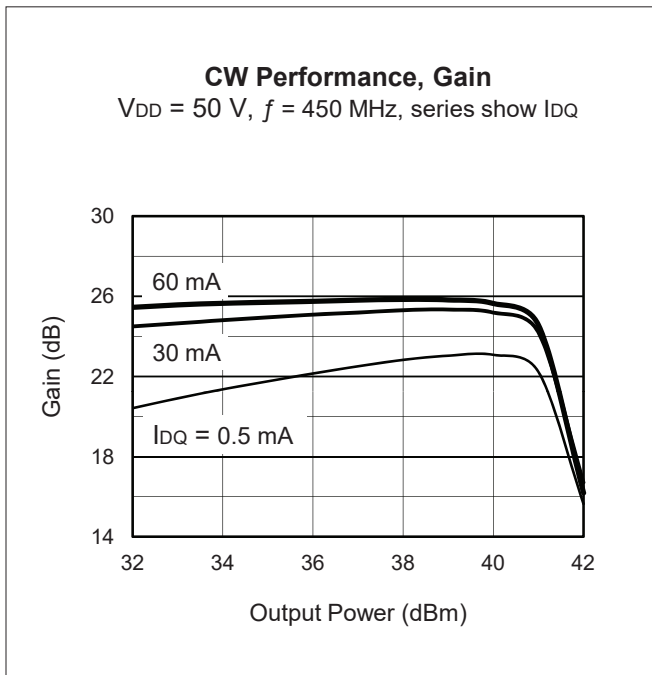
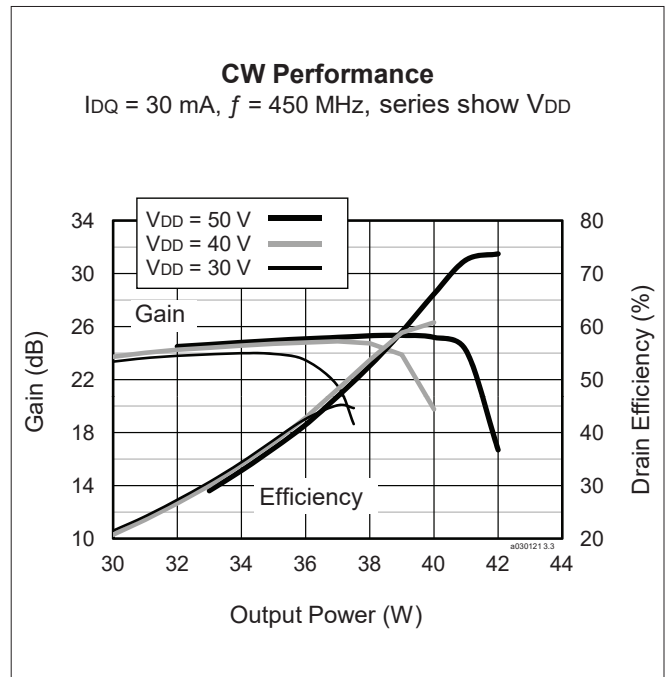
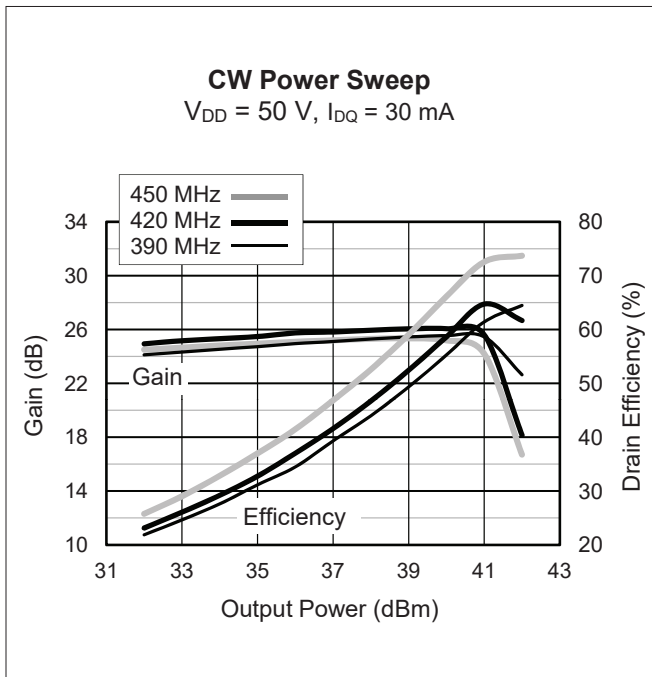

Broadband Circuit Impedance

Frequency MHz	Z Source Ω		Z Load Ω	
	R	jX	R	jX
390	22.20	34.88	4.26	15.04
405	21.95	34.74	4.46	15.82
420	21.39	34.99	4.66	16.62
435	20.61	35.80	4.88	17.42
450	19.77	37.03	5.11	18.23

Reference Circuit

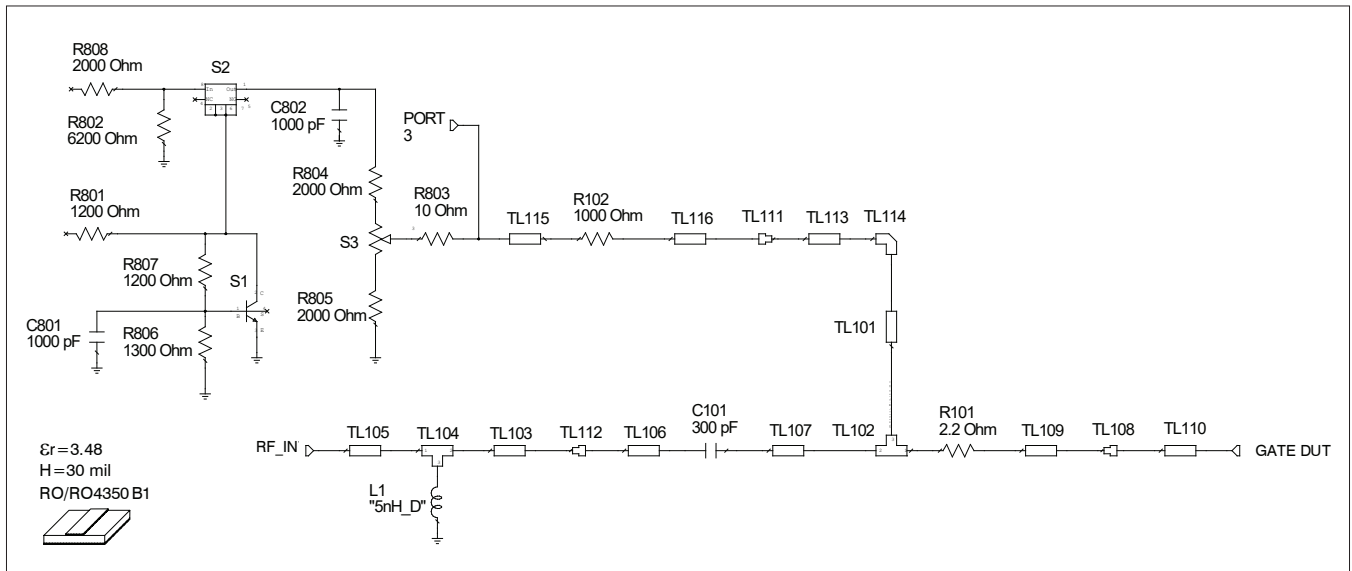

Reference circuit input schematic for $f = 450$ MHz

Reference Circuit (cont.)

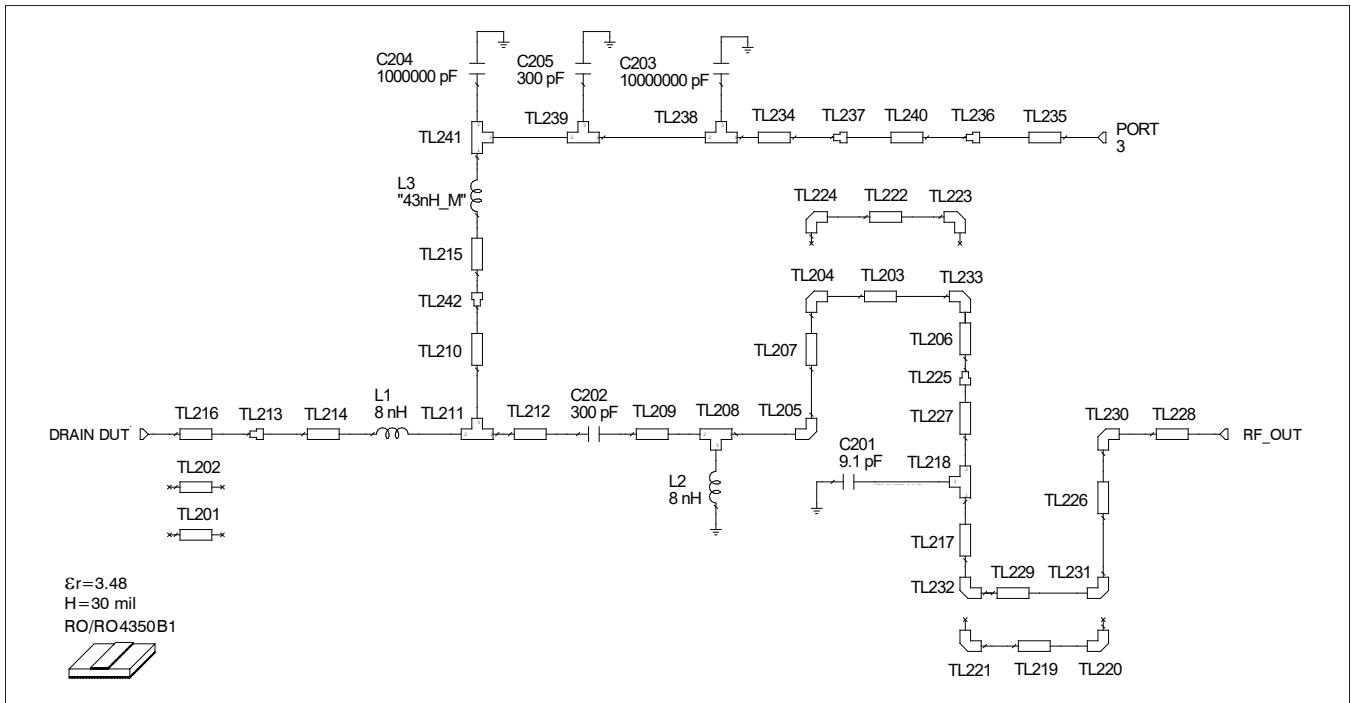

Reference circuit output schematic for $f = 450 \text{ MHz}$

Reference Circuit Assembly

DUT	PTFA030121EA
Test Fixture Part No.	LTN/PTFA030121EA
PCB	Rogers RO4350, 0.508 mm [0.020"] thick, 1 oz. copper, $\epsilon_r = 3.48$
Find Gerber files for this test fixture on the Wolfspeed Web site at www.wolfspeed.com/RF	

Electrical Characteristics at 450 MHz

Transmission Line	Electrical Characteristics	Dimensions: mm	Dimensions: mils
Input			
TL101	0.009 λ , 92.76 Ω	W = 0.51, L = 3.81	W = 20, L = 150
TL102	0.001 λ , 45.29 Ω	W1 = 2.03, W2 = 2.03, W3 = 0.51	W1 = 80, W2 = 80, W3 = 20
TL103	0.001 λ , 52.21 Ω	W = 1.63, L = 0.43	W = 64, L = 17
TL105	0.025 λ , 52.21 Ω	W = 1.63, L = 10.13	W = 64, L = 39
TL106, TL109	0.003 λ , 45.29 Ω	W = 2.03, L = 1.27	W = 80, L = 50
TL107	0.002 λ , 45.29 Ω	W = 2.03, L = 0.76	W = 80, L = 30
TL110	0.013 λ , 16.51 Ω	W = 7.62, L = 5.08	W = 300, L = 200
TL113	0.002 λ , 92.76 Ω	W = 0.51, L = 1.02	W = 20, L = 40
TL115	0.013 λ , 54.31 Ω	W = 1.52, L = 5.08	W = 60, L = 200
TL116	0.003 λ , 54.31 Ω	W = 1.52, L = 1.02	W = 60, L = 40

table continued next page

Reference Circuit (cont.)

Electrical Characteristics at 450 MHz

Transmission Line	Electrical Characteristics	Dimensions: mm	Dimensions: mils
Output			
TL201, TL202	0.005 λ , 45.29 Ω	W = 2.03, L = 2.04	W = 80, L = 81
TL203	0.006 λ , 38.92 Ω	W = 2.54, L = 2.54	W = 100, L = 100
TL206, TL207	0.029 λ , 38.92 Ω	W = 2.54, L = 11.43	W = 100, L = 450
TL209	0.009 λ , 38.92 Ω	W = 2.54, L = 3.56	W = 100, L = 140
TL210	0.018 λ , 78.46 Ω	W = 0.76, L = 7.62	W = 30, L = 300
TL211	0.002 λ , 25.11 Ω	W1 = 4.57, W2 = 4.57, W3 = 0.76	W1 = 180, W2 = 180, W3 = 30
TL212	0.003 λ , 25.11 Ω	W = 4.57, L = 1.27	W = 180, L = 50
TL214	0.004 λ , 25.11 Ω	W = 4.57, L = 1.52	W = 180, L = 60
TL215	0.010 λ , 23.09 Ω	W = 5.08, L = 3.81	W = 200, L = 150
TL216	0.013 λ , 16.51 Ω	W = 7.62, L = 5.08	W = 300, L = 200
TL217	0.018 λ , 52.21 Ω	W = 1.63, L = 7.29	W = 64, L = 287
TL219	0.006 λ , 52.21 Ω	W = 1.63, L = 2.41	W = 64, L = 95
TL222	0.006 λ , 38.92 Ω	W = 2.54, L = 2.54	W = 100, L = 100
TL226	0.018 λ , 52.21 Ω	W = 1.63, L = 7.34	W = 64, L = 289
TL227	0.002 λ , 52.21 Ω	W = 1.63, L = 0.84	W = 64, L = 33
TL228	0.006 λ , 52.21 Ω	W = 1.63, L = 2.30	W = 64, L = 91
TL229	0.006 λ , 52.21 Ω	W = 1.63, L = 2.41	W = 64, L = 95
TL234	0.005 λ , 27.14 Ω	W = 4.14, L = 2.12	W = 163, L = 84
TL235	0.014 λ , 34.38 Ω	W = 3.02, L = 5.51	W = 119, L = 2 17
TL240	0.026 λ , 61.53 Ω	W = 1.23, L = 10.63	W = 48, L = 419
TL241	0.010 λ , 38.92 Ω	W1 = 2.54, W2 2.54, W3 = 4.14	W1 = 100, W2 = 100, W3 = 163

Reference Circuit (cont.)

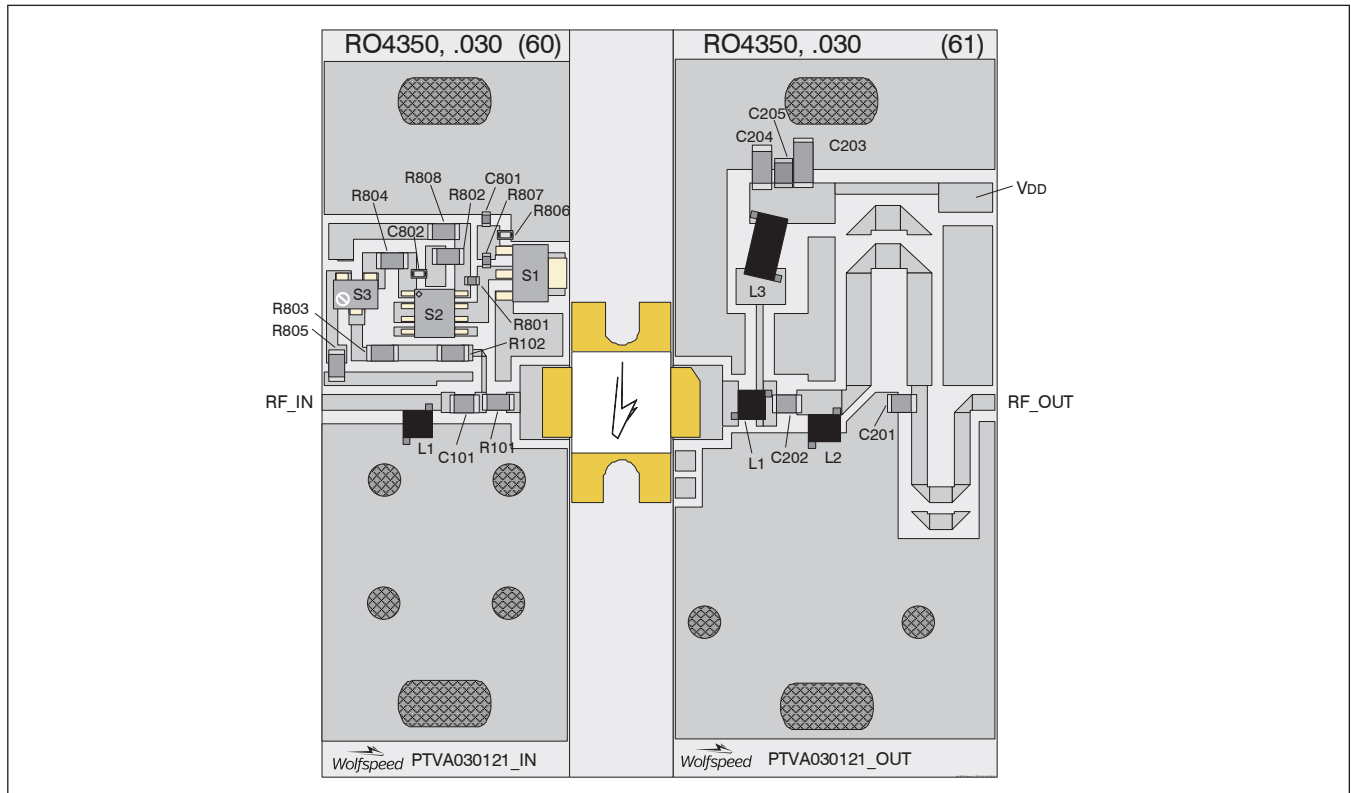

Reference circuit assembly diagram (not to scale)

Component ID	Description	Suggested Supplier	P/N
Input			
C101	Chip capacitor, 300 pF	ATC	ATC100B301JW200XB
C801, C802	Capacitor, 1000 pF	Panasonic Electronic Components	ECJ-1VB1H102K
L1	Inductor, 5 nH	Coilcraft	A02TGLB
R101	Resistor, 2.2 Ω	Panasonic Electronic Components	ERJ-8GEYJ2R2V
R102	Resistor, 1000 Ω	Panasonic Electronic Components	ERJ-8GEYJ102V
R801, R807	Resistor, 1200 Ω	Panasonic Electronic Components	ERJ-3GEYJ122V
R802	Resistor, 6200 Ω	Panasonic Electronic Components	ERJ-8GEYJ622V
R803	Resistor, 10 Ω	Panasonic Electronic Components	ERJ-8GEYJ100V
R804, R805, R808	Resistor, 2000 Ω	Panasonic Electronic Components	ERJ-8GEYJ202V
R806	Resistor, 1300 Ω	Panasonic Electronic Components	ERJ-3GEYJ132V
S1	Transistor	Infineon Technologies	BCP56
S2	Voltage regulator	Fairchild Semiconductor	LM7805CT
S3	Potentiometer, 2K Ω	Bourns Inc.	3224W-1-202E

table continued next page

Reference Circuit (cont.)

Component ID	Description	Suggested Supplier	P/N
Output			
C201	Chip capacitor, 9.1 pF	ATC	ATC100B9R1BW500XB
C202	Chip capacitor, 300 pF	ATC	ATC100B301JW200XB
C203	Chip capacitor, 10 μ F	TDK Corporation	C5750X7S2A106M230KB
C204	Capacitor, 1 μ F	TDK Corporation	C4532X7R2A105K230KA
C205	Chip capacitor, 300 pF	ATC	ATC100B301JW200XB
L1, L2	Inductor, 8 nH	Coilcraft	A03TGLB
L3	Inductor, 43 nH	Coilcraft	B10TGLB

See next page for package mechanical specifications

Package Outline Specifications

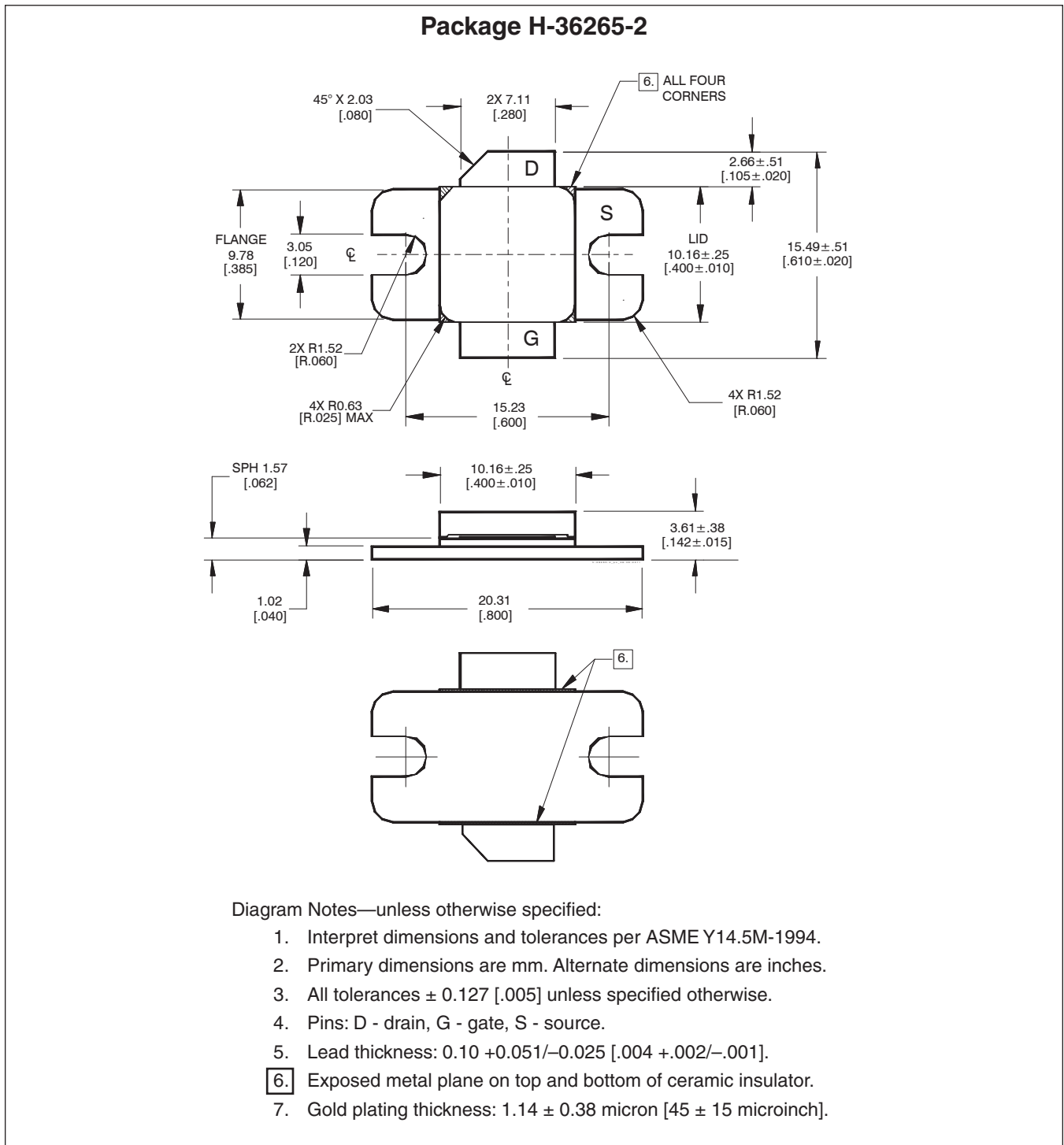

Revision History

Revision	Date	Data Sheet Type	Page	Subjects (major changes since last revision)
01	2010-10-08	Advance	All	Data Sheet reflects advance specification for product development
02	2010-12-13	Advance	All	Change part number
03	2011-05-07	Preliminary	All	Change part number, update to Preliminary, add specifications
04	2011-11-10	Production	All	Data Sheet reflects released product specification
05	2013-07-02	Production	2 7, 8	Update DC Characteristics and Max Ratings table, add order codes Add manufacturer
05.1	2016-04-19	Production	1, 2	Added ESD rating, updated ordering information
05.2	2017-02-02	Production	2	Updated operating voltage and junction temperature
06	2018-06-13	Production	All	Converted to Wolfspeed Data Sheet

For more information, please contact:

4600 Silicon Drive
Durham, North Carolina, USA 27703
www.wolfspeed.com/RF

Sales Contact
RFSales@wolfspeed.com

RF Product Marketing Contact
RFMarketing@wolfspeed.com
919.407.7816

Notes

Disclaimer

Specifications are subject to change without notice. Cree, Inc. believes the information contained within this data sheet to be accurate and reliable. However, no responsibility is assumed by Cree for any infringement of patents or other rights of third parties which may result from its use. No license is granted by implication or otherwise under any patent or patent rights of Cree. Cree makes no warranty, representation or guarantee regarding the suitability of its products for any particular purpose. "Typical" parameters are the average values expected by Cree in large quantities and are provided for information purposes only. These values can and do vary in different applications and actual performance can vary over time. All operating parameters should be validated by customer's technical experts for each application. Cree products are not designed, intended or authorized for use as components in applications intended for surgical implant into the body or to support or sustain life, in applications in which the failure of the Cree product could result in personal injury or death or in applications for planning, construction, maintenance or direct operation of a nuclear facility.



Стандарт Электрон Связь

Мы молодая и активно развивающаяся компания в области поставок электронных компонентов. Мы поставляем электронные компоненты отечественного и импортного производства напрямую от производителей и с крупнейших складов мира.

Благодаря сотрудничеству с мировыми поставщиками мы осуществляем комплексные и плановые поставки широчайшего спектра электронных компонентов.

Собственная эффективная логистика и склад в обеспечивает надежную поставку продукции в точно указанные сроки по всей России.

Мы осуществляем техническую поддержку нашим клиентам и предпродажную проверку качества продукции. На все поставляемые продукты мы предоставляем гарантию .

Осуществляем поставки продукции под контролем ВП МО РФ на предприятия военно-промышленного комплекса России , а также работаем в рамках 275 ФЗ с открытием отдельных счетов в уполномоченном банке. Система менеджмента качества компании соответствует требованиям ГОСТ ISO 9001.

Минимальные сроки поставки, гибкие цены, неограниченный ассортимент и индивидуальный подход к клиентам являются основой для выстраивания долгосрочного и эффективного сотрудничества с предприятиями радиоэлектронной промышленности, предприятиями ВПК и научно-исследовательскими институтами России.

С нами вы становитесь еще успешнее!

Наши контакты:

Телефон: +7 812 627 14 35

Электронная почта: sales@st-electron.ru

Адрес: 198099, Санкт-Петербург,
Промышленная ул, дом № 19, литера Н,
помещение 100-Н Офис 331