

DR45 SERIES

AC SINGLE PHASE OUTPUT DIN RAIL MOUNT SSRS

Introduction

The DR45 is a powerful and compact solid state relay in a DIN rail 45mm wide package with an output rating up to 60 Amps @ 40°C offering mounting flexibility (on panel or DIN rail) and convenient input connection options. Its high I²t capability and optional built-in overvoltage protection make it suitable for demanding heating, motion and lighting applications. Its contactor configuration and large cage clamp terminals allow connecting wires up to 3 AWG size on the output without the use of any additional accessories making them truly ready-to-use devices, therefore reducing installation cost and time.

UL Listed and VDE certified, the DR45 is a safe and versatile solid state relay with superior performance when compared to previous generation and competitor products in similar sized packages.



Features

- Output ratings up to 60 Amps at 600 VAC
- Built-in overvoltage protection
- Integral heat sink eliminates the need for complex thermal calculations
- Cage clamp terminal type accept up to 3 AWG wire size
- IP20 touch-safe housing
- Contactor configuration
- AC or DC control
- C-UL-US Listed and VDE approved

Applications

- Plastic injection molding equipment
- Packaging equipment
- Industrial ovens
- Lighting control
- Pump control
- Conveyor drives
- HVAC&R
- Railway vehicles

PRODUCT SELECTION

NOVA22

| Control Voltage | 45A | 60A |
|-----------------|------------|------------|
| 90-280 VAC/VDC | DR4560A45x | DR4560A60x |
| 4-32 VDC | DR4560D45x | DR4560D60x |

ORDERING OPTIONS

| | | | | | | | |
|--|-------------|-----------|----------|-----------|----------|----------|----------|
| | DR45 | 60 | A | 45 | R | P | J |
| Series | | | | | | | |
| DR45 | | | | | | | |
| Operating Voltage | | | | | | | |
| 60: 48-600 VAC | | | | | | | |
| Control Voltage (1) | | | | | | | |
| A: 90-280 VAC/VDC D: 4-32 VDC | | | | | | | |
| Rated Load Current | | | | | | | |
| 45: 45 Amps 60: 60 Amps | | | | | | | |
| Switching Type | | | | | | | |
| Blank: Zero Voltage Turn-On R: Instantaneous Turn-On (Motor Rating Certified) | | | | | | | |
| Overvoltage Protection | | | | | | | |
| Blank: Not Included P: Included | | | | | | | |
| Input Connector | | | | | | | |
| Blank: Screw Terminal J: Spring Terminal | | | | | | | |

 Required for valid part number
 For options only and not required for valid part number

OUTPUT SPECIFICATIONS (2)

| Description | 45A | 60A |
|---|-----------|-----------|
| Operating Voltage (45-65Hz) [V _{RMS}] | 48-600 | 48-600 |
| Transient Overvoltage [V _{pk}] (3) | 1200 | 1200 |
| Maximum Off-State Leakage Current @ Rated Voltage [mA _{RMS}] | 1 | 1 |
| Minimum Off-State dV/dt @ Maximum Rated Voltage [V/μsec] | 500 | 500 |
| Load Current, General Use UL508/LC A IEC62314 @ 40°C [A _{RMS}] | 45 | 60 |
| Load Current, Motor Starting UL508 FLA/LC B IEC62314 @ 40°C [A _{RMS}] | 14/7.6 | 26/14 |
| Minimum Load Current [mA _{RMS}] | 100 | 150 |
| Maximum 1 Cycle Surge Current (50/60Hz) [A _{pk}] | 716/750 | 1290/1350 |
| Maximum On-State Voltage Drop @ Rated Current [V _{RMS}] | 1.25 | 1.15 |
| Maximum 1/2 Cycle I ² t for Fusing (50/60Hz) [A ² sec] | 2563/2343 | 8320/7593 |
| Maximum Power Dissipation @ Rated Current [W] | 52 | 69 |
| Minimum Power Factor (at Maximum Load) (4) | 0.5 | 0.5 |
| Motor Rating UL 508/IEC62314 [HP (kW)]: 120 VAC | 1 (0.74) | 2 (1.5) |
| Motor Rating UL 508/IEC62314 [HP (kW)]: 240 VAC | 3 (2.2) | 5 (3.73) |
| Motor Rating UL 508/IEC62314 [HP (kW)]: 480 VAC | 5 (3.7) | 10 (7.4) |

INPUT SPECIFICATIONS (2)

| Description | DR4560Dxxx | DR4560Axxx |
|--------------------------------------|-----------------|----------------|
| Control Voltage Range | 4-32 VDC (5) | 90-280 VAC/VDC |
| Maximum Reverse Voltage | -32 VDC | - |
| Minimum Turn-On Voltage | 4 VDC | 90 VAC/VDC |
| Must Turn-Off Voltage | 1 VDC | 5 VAC/VDC |
| Minimum Input Current (for on-state) | 10 mA | 3 mA |
| Maximum Input Current | 15 mA | 4 mA |
| Nominal Input Impedance | Current Limited | Switch Mode |
| Maximum Turn-On Time [msec] | 1/2 Cycle (6) | 20 |
| Maximum Turn-Off Time [msec] | 1/2 Cycle | 30 |

GENERAL SPECIFICATIONS (2)

| Description | Parameters |
|---|-----------------------|
| Dielectric Strength, Input to Output (50/60Hz) | 4000 V _{RMS} |
| Dielectric Strength, Input/Output to Case (50/60Hz) | 4000 V _{RMS} |
| Minimum Insulation Resistance (@ 500 VDC) | 10 ⁹ Ohms |
| Maximum Capacitance, Input/Output | 8 pF |
| Ambient Operating Temperature Range | -40 to 80 °C |
| Ambient Storage Temperature Range (7) | -40 to 100 °C |
| Short Circuit Current Rating (8) | 100kA |
| Weight (typical) | 17.63 oz (500 g) |
| Housing Material | UL94 V-0 |
| Heat Sink Material | Aluminum |
| DIN Rail Clip Material | Zinc Plated Steel |
| Hardware Finish | Nickel Plating |
| Input Terminal Screw Torque Range (lb-in/Nm) | 5/0.5 |
| Load Terminal Screw Torque Range (lb-in/Nm) | 18-20/2-2.2 |
| Humidity per IEC 60068-2-78 | 93% non-condensing |
| LED Input Status Indicator | Green |
| Overvoltage Category | III |
| Impulse Withstand Voltage According to IEC 60664-1 | 6kV |

INPUT CURRENT INFORMATION

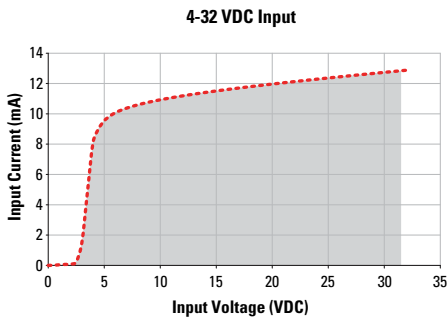

SURGE CURRENT INFORMATION

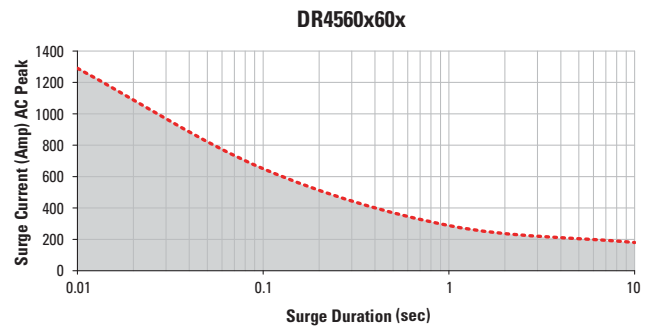
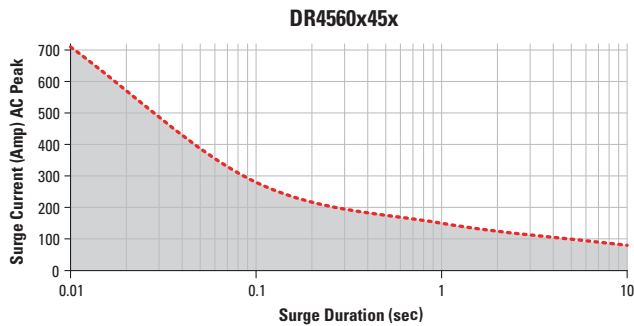

THERMAL DERATE INFORMATION (10)

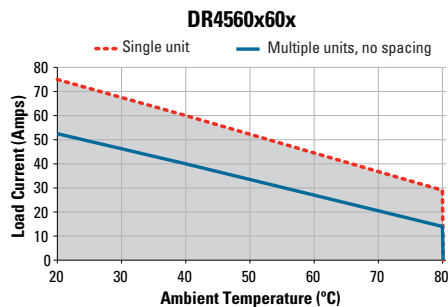
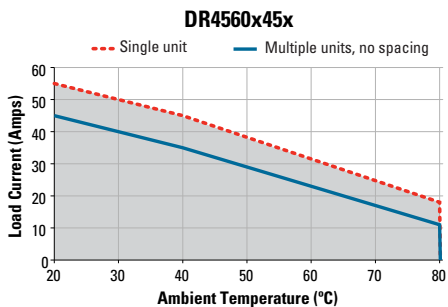

EQUIVALENT CIRCUIT BLOCK DIAGRAMS/WIRING DIAGRAMS

DC Control * TVS option available in "P" version

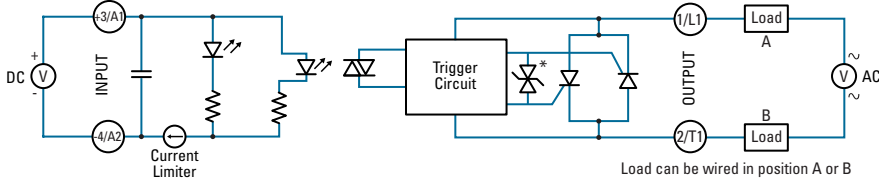

AC/DC Control * TVS option available in "P" version

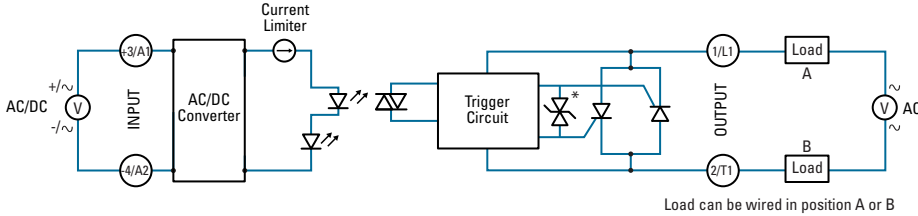

INSTALLATION INSTRUCTIONS

Mounting on DIN Rail

- Locate rail and align with non moveable end of DR45 DIN clip.
- Using reasonable force, push DR45 in the direction of the arrow (as shown in fig.1).
- For removal pull release tag in direction of arrow using blade of screwdriver and pull it away from DIN rail.

Mounting on Panel

- Locate the panel section on which the DR45 SSR will be mounted on (as shown in fig.2)
- DIN clip includes tabs for this type of mounting. Tab holes have a diameter of 4.5 mm. You will need three screws (not included) no larger than that to mount the SSR onto panel.
- Align SSR tabs with panel surface and screw both top and bottom sides. Recommended torque is 12 in-lbs (1.36 Nm).

Wiring Instructions

- Recommended wire sizes as shown in TABLE 1
- Maximum terminal screw torque input terminal 5 lb-in (0.5 Nm) (screw terminal only)
- Maximum terminal screw torque load terminal 18-20 lb-in (2.0-2.2 Nm)
- If multiple units are installed be sure to follow derating curves

| Terminal Configuration | Recommended Wire Size (Solid / Stranded) | Wire Pull-Out Strength (lb)[N]* | |
|------------------------|--|--|----------|
| Output | 1 x 18 AWG (1 mm ²) [minimum] | 20 [88] | |
| | 1 x 8 AWG (10 mm ²) [maximum] | 90 [400] | |
| | 2 x 8 AWG (10 mm ²) [maximum] | 80 [355] | |
| | 1 x 3 AWG (26.67 mm ²) [maximum] | 90 [400] | |
| Input | Screw | 30 AWG (0.05 mm ²) [minimum] | 4.5 [20] |
| | | 12 AWG (3.3 mm ²) [maximum] | 30 [133] |
| | Spring | 26 AWG (0.13 mm ²) [minimum] | 5 [22] |
| | | 12 AWG (3.3 mm ²) [maximum] | 5 [22] |

* Tests performed on Stranded wire

WARNING! Removing product from 35 mm rail incorrectly by not using the appropriate tool would damage the latching system.

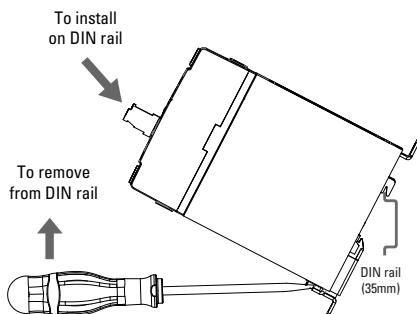

fig. 1 SSR mounted on DIN rail

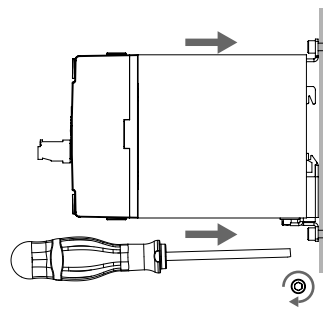
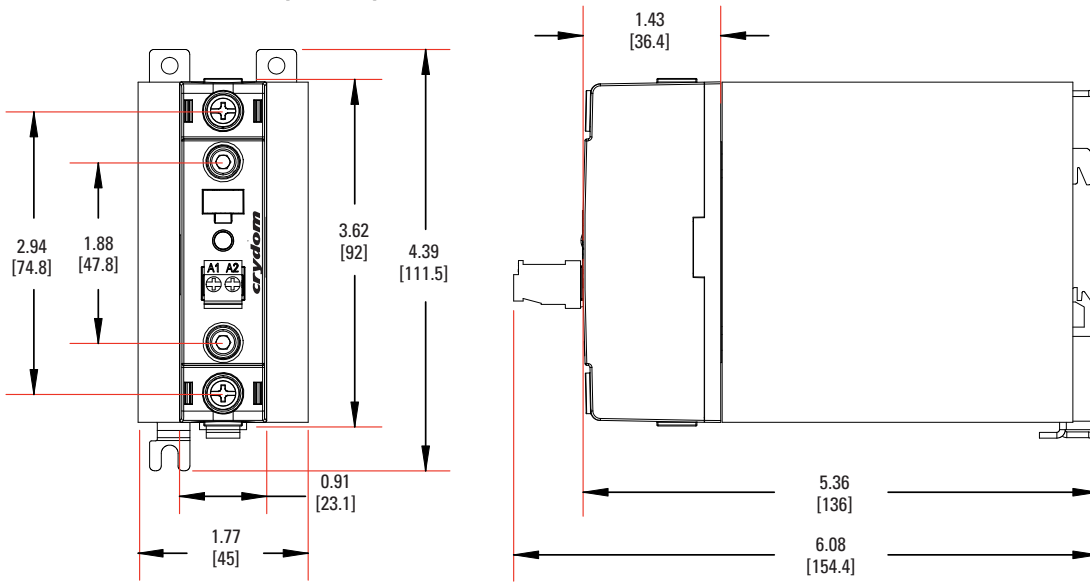



fig. 2 SSR mounted on Panel Mount

MECHANICAL SPECIFICATIONS

Tolerances: ± 0.02 in / 0.5 mm
 All dimensions are in: inches [millimeters]

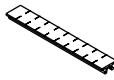

ACCESSORIES

| Recommended Accessories | |
|--|--|
|  |  |
| Connectors | ID Marker |
| CP201 Screw Terminal | CNLB Blank Strips |
| CP202 Spring Terminal | CNLN Numbered 1 to 10 Strips |
| | CNL2 Numbered 11 to 20 Strips |

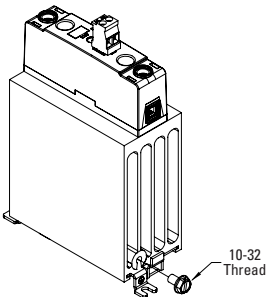

Protective Earth Connection







Protective earth (PE) screw type recommended is 10-32 UNC standard not provided with SSR. Through the use of a DIN rail ground (protective conductor) terminal block, the DIN rail itself can be used as the grounding bus bar. In this case, the zinc plated steel material used for the DIN rail clip of DR45 models, permits a secure path to ground and avoid the need of a further PE connection.



AGENCY APPROVALS, CONFORMANCES, ENVIRONMENTAL AND EMC

| Approvals (Tested and Certified according To) | |
|---|--|
|  E116949 |  REG-Nr. xxxxxx |
| UL 508 and C22.2 No. 14 | EN 62314 |

| Conformances | | | | Environmental | |
|---------------------------------------|------------------------------------|-------------------------------------|---|---|---|
| Vibration and Shock Resistance | Designed in accordance with | Resistances to heat and fire |  |  |  |
| IEC 61373: Category 1, Class B | IEC 60950-1 | IEC 60335-1, Section 30 | Directive 2006/95/EC | Directive 2011/65/EU | GBT 26572-2011 |

| Electromagnetic Compatibility | | | | |
|--|--|--------------------------|-------------------|-------------|
| Generic Standard | Immunity Tests | Test Specification Level | | Performance |
|  IEC 61000-6-2 Immunity for Industrial Environments | Electrostatic Discharge IEC 61000-4-2 | 8kV air discharge | | Criterion A |
| | | 6kV contact discharge | | Criterion A |
| | Fast transients (burst) IEC 61000-4-4 | Output | 2kV, 5kHz, 100kHz | Criterion B |
| | | Input | 1kV, 5kHz, 100kHz | Criterion B |
| | Surge IEC 61000-4-5 | Output | 1kV Line to Line | Criterion B |
| | | | 2kV Line to Earth | Criterion B |
| | | AC Input Option | 1kV Line to Line | Criterion A |
| | | | 2kV Line to Earth | Criterion A |



GENERAL NOTES

- (1) Control voltage 18-52 VAC/VDC is available upon request.
- (2) All parameters at 25°C unless otherwise specified.
- (3) "P" option output will self trigger between 900-1200 Vpk, not suitable for capacitive loads.
- (4) High inductive loads requires nominal control voltage; AC input models only.
- (5) Increase minimum voltage by 1 V for operations from -20 to -40°C.
- (6) Turn-on time for Instantaneous turn-on versions is 0.1 msec.
- (7) No freezing or condensation allowed.
- (8) When protected with the appropriate class and rated fuse. For detailed info please contact Crydom Technical Support.
- (9) For single surge pulse $T_c=25^\circ\text{C}$; $T_j=125^\circ\text{C}$. For AC Output SSRs, AC RMS value of surge current equals the peak value divided by $\sqrt{2}$ (1.414).
- (10) UL approved rating is the one that intersects at 40°C.

Sensata Technologies, Inc. ("Sensata") data sheets are solely intended to assist designers ("Buyers") who are developing systems that incorporate Sensata products (also referred to herein as "components"). Buyer understands and agrees that Buyer remains responsible for using its independent analysis, evaluation and judgment in designing Buyer's systems and products. Sensata data sheets have been created using standard laboratory conditions and engineering practices. Sensata has not conducted any testing other than that specifically described in the published documentation for a particular data sheet. Sensata may make corrections, enhancements, improvements and other changes to its data sheets or components without notice.

Buyers are authorized to use Sensata data sheets with the Sensata component(s) identified in each particular data sheet. HOWEVER, NO OTHER LICENSE, EXPRESS OR IMPLIED, BY ESTOPPEL OR OTHERWISE TO ANY OTHER SENSATA INTELLECTUAL PROPERTY RIGHT, AND NO LICENSE TO ANY THIRD PARTY TECHNOLOGY OR INTELLECTUAL PROPERTY RIGHT, IS GRANTED HEREIN. SENSATA DATA SHEETS ARE PROVIDED "AS IS". SENSATA MAKES NO WARRANTIES OR REPRESENTATIONS WITH REGARD TO THE DATA SHEETS OR USE OF THE DATA SHEETS, EXPRESS, IMPLIED OR STATUTORY, INCLUDING ACCURACY OR COMPLETENESS. SENSATA DISCLAIMS ANY WARRANTY OF TITLE AND ANY IMPLIED WARRANTIES OF MERCHANTABILITY, FITNESS FOR A PARTICULAR PURPOSE, QUIET ENJOYMENT, QUIET POSSESSION, AND NON-INFRINGEMENT OF ANY THIRD PARTY INTELLECTUAL PROPERTY RIGHTS WITH REGARD TO SENSATA DATA SHEETS OR USE THEREOF.

All products are sold subject to Sensata's terms and conditions of sale supplied at www.sensata.com SENSATA ASSUMES NO LIABILITY FOR APPLICATIONS ASSISTANCE OR THE DESIGN OF BUYERS' PRODUCTS. BUYER ACKNOWLEDGES AND AGREES THAT IT IS SOLELY RESPONSIBLE FOR COMPLIANCE WITH ALL LEGAL, REGULATORY AND SAFETY-RELATED REQUIREMENTS CONCERNING ITS PRODUCTS, AND ANY USE OF SENSATA COMPONENTS IN ITS APPLICATIONS, NOTWITHSTANDING ANY APPLICATIONS-RELATED INFORMATION OR SUPPORT THAT MAY BE PROVIDED BY SENSATA.

Mailing Address: Sensata Technologies, Inc., 529 Pleasant Street, Attleboro, MA 02703, USA.

CONTACT US

Americas

+1 (877) 502 5500 – Option 2
sales.crydom@sensata.com

Europe, Middle East & Africa

+44 (1202) 416170
ssr-info.eu@sensata.com

Asia Pacific

sales.isasia@list.sensata.com
China +86 (21) 2306 1500
Japan +81 (45) 277 7117
Korea +82 (31) 601 2004
India +91 (80) 67920890
Rest of Asia +886 (2) 27602006
ext 2808



Стандарт Электрон Связь

Мы молодая и активно развивающаяся компания в области поставок электронных компонентов. Мы поставляем электронные компоненты отечественного и импортного производства напрямую от производителей и с крупнейших складов мира.

Благодаря сотрудничеству с мировыми поставщиками мы осуществляем комплексные и плановые поставки широчайшего спектра электронных компонентов.

Собственная эффективная логистика и склад в обеспечивает надежную поставку продукции в точно указанные сроки по всей России.

Мы осуществляем техническую поддержку нашим клиентам и предпродажную проверку качества продукции. На все поставляемые продукты мы предоставляем гарантию .

Осуществляем поставки продукции под контролем ВП МО РФ на предприятия военно-промышленного комплекса России , а также работаем в рамках 275 ФЗ с открытием отдельных счетов в уполномоченном банке. Система менеджмента качества компании соответствует требованиям ГОСТ ISO 9001.

Минимальные сроки поставки, гибкие цены, неограниченный ассортимент и индивидуальный подход к клиентам являются основой для выстраивания долгосрочного и эффективного сотрудничества с предприятиями радиоэлектронной промышленности, предприятиями ВПК и научно-исследовательскими институтами России.

С нами вы становитесь еще успешнее!

Наши контакты:

Телефон: +7 812 627 14 35

Электронная почта: sales@st-electron.ru

Адрес: 198099, Санкт-Петербург,
Промышленная ул, дом № 19, литера Н,
помещение 100-Н Офис 331