



Is Now Part of



**ON Semiconductor®**

To learn more about ON Semiconductor, please visit our website at  
[www.onsemi.com](http://www.onsemi.com)

Please note: As part of the Fairchild Semiconductor integration, some of the Fairchild orderable part numbers will need to change in order to meet ON Semiconductor's system requirements. Since the ON Semiconductor product management systems do not have the ability to manage part nomenclature that utilizes an underscore (\_), the underscore (\_) in the Fairchild part numbers will be changed to a dash (-). This document may contain device numbers with an underscore (\_). Please check the ON Semiconductor website to verify the updated device numbers. The most current and up-to-date ordering information can be found at [www.onsemi.com](http://www.onsemi.com). Please email any questions regarding the system integration to [Fairchild\\_questions@onsemi.com](mailto:Fairchild_questions@onsemi.com).

ON Semiconductor and the ON Semiconductor logo are trademarks of Semiconductor Components Industries, LLC dba ON Semiconductor or its subsidiaries in the United States and/or other countries. ON Semiconductor owns the rights to a number of patents, trademarks, copyrights, trade secrets, and other intellectual property. A listing of ON Semiconductor's product/patent coverage may be accessed at [www.onsemi.com/site/pdf/Patent-Marking.pdf](http://www.onsemi.com/site/pdf/Patent-Marking.pdf). ON Semiconductor reserves the right to make changes without further notice to any products herein. ON Semiconductor makes no warranty, representation or guarantee regarding the suitability of its products for any particular purpose, nor does ON Semiconductor assume any liability arising out of the application or use of any product or circuit, and specifically disclaims any and all liability, including without limitation special, consequential or incidental damages. Buyer is responsible for its products and applications using ON Semiconductor products, including compliance with all laws, regulations and safety requirements or standards, regardless of any support or applications information provided by ON Semiconductor. "Typical" parameters which may be provided in ON Semiconductor data sheets and/or specifications can and do vary in different applications and actual performance may vary over time. All operating parameters, including "Typicals" must be validated for each customer application by customer's technical experts. ON Semiconductor does not convey any license under its patent rights nor the rights of others. ON Semiconductor products are not designed, intended, or authorized for use as a critical component in life support systems or any FDA Class 3 medical devices or medical devices with a same or similar classification in a foreign jurisdiction or any devices intended for implantation in the human body. Should Buyer purchase or use ON Semiconductor products for any such unintended or unauthorized application, Buyer shall indemnify and hold ON Semiconductor and its officers, employees, subsidiaries, affiliates, and distributors harmless against all claims, costs, damages, and expenses, and reasonable attorney fees arising out of, directly or indirectly, any claim of personal injury or death associated with such unintended or unauthorized use, even if such claim alleges that ON Semiconductor was negligent regarding the design or manufacture of the part. ON Semiconductor is an Equal Opportunity/Affirmative Action Employer. This literature is subject to all applicable copyright laws and is not for resale in any manner.



June 2015

# HMHA281, HMHA2801 Series 4-Pin Half-Pitch Mini-Flat Phototransistor Optocouplers

## Features

- Compact 4-pin Package
  - 2.4 mm Maximum Standoff Height
  - Half-pitch Leads for Optimum Board Space Savings
- Current Transfer Ratio:
  - HMHA281: 50% to 600%
  - HMHA2801: 80% to 600%
  - HMHA2801A: 80% to 160%
  - HMHA2801B: 130% to 260%
  - HMHA2801C: 200% to 400%
- Safety and Regulatory Approvals:
  - UL1577, 3,750 VAC<sub>RMS</sub> for 1 Minute
  - DIN-EN/IEC60747-5-5, 565 V Peak Working Insulation Voltage

## Applications

- Digital Logic Inputs
- Microprocessor Inputs
- Power Supply Monitor
- Twisted Pair Line Receiver
- Telephone Line Receiver

## Description

The HMHA281 and HMHA2801 series devices consist of a gallium arsenide infrared emitting diode driving a silicon phototransistor in a compact 4-pin mini-flat package. The lead pitch is 1.27 mm.

## Schematic

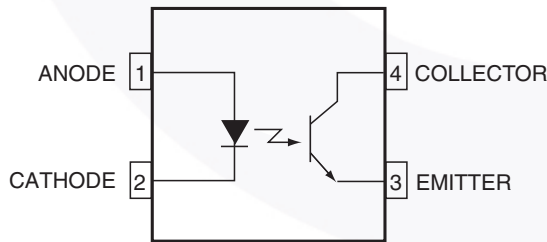

Figure 1. Schematic

## Package Outline

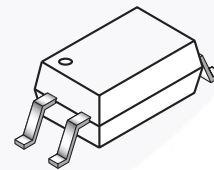

Figure 2. Package Outlines

## Safety and Insulation Ratings

As per DIN EN/IEC 60747-5-5, this optocoupler is suitable for “safe electrical insulation” only within the safety limit data. Compliance with the safety ratings shall be ensured by means of protective circuits.

Parameter		Characteristics
Installation Classifications per DIN VDE 0110/1.89 Table 1, For Rated Mains Voltage	< 150 V <sub>RMS</sub>	I–IV
	< 300 V <sub>RMS</sub>	I–III
Climatic Classification		55/100/21
Pollution Degree (DIN VDE 0110/1.89)		2
Comparative Tracking Index		175

Symbol	Parameter	Value	Unit
V <sub>PR</sub>	Input-to-Output Test Voltage, Method A, V <sub>IORM</sub> × 1.6 = V <sub>PR</sub> , Type and Sample Test with t <sub>m</sub> = 10 s, Partial Discharge < 5 pC	904	V <sub>peak</sub>
	Input-to-Output Test Voltage, Method B, V <sub>IORM</sub> × 1.875 = V <sub>PR</sub> , 100% Production Test with t <sub>m</sub> = 1 s, Partial Discharge < 5 pC	1060	V <sub>peak</sub>
V <sub>IORM</sub>	Maximum Working Insulation Voltage	565	V <sub>peak</sub>
V <sub>IOTM</sub>	Highest Allowable Over-Voltage	4000	V <sub>peak</sub>
	External Creepage	≥ 5	mm
	External Clearance	≥ 5	mm
DTI	Distance Through Insulation (Insulation Thickness)	≥ 0.4	mm
T <sub>S</sub>	Case Temperature <sup>(1)</sup>	150	°C
I <sub>S,INPUT</sub>	Input Current <sup>(1)</sup>	200	mA
P <sub>S,OUTPUT</sub>	Output Power <sup>(1)</sup>	300	mW
R <sub>IO</sub>	Insulation Resistance at T <sub>S</sub> , V <sub>IO</sub> = 500 V <sup>(1)</sup>	> 10 <sup>9</sup>	Ω

### Note:

1. Safety limit values – maximum values allowed in the event of a failure.

## Absolute Maximum Ratings

Stresses exceeding the absolute maximum ratings may damage the device. The device may not function or be operable above the recommended operating conditions and stressing the parts to these levels is not recommended. In addition, extended exposure to stresses above the recommended operating conditions may affect device reliability. The absolute maximum ratings are stress ratings only.

Symbol	Parameter	Value	Units
<b>TOTAL PACKAGE</b>			
$T_{STG}$	Storage Temperature	-55 to +125	°C
$T_{OPR}$	Operating Temperature	-55 to +100	°C
$T_J$	Junction Temperature	-40 to +125	°C
$P_D$	Total Device Power Dissipation @ $T_A = 25^\circ\text{C}$	210	mW
	Derate Above $25^\circ\text{C}$	2.1	mW/°C
<b>EMITTER</b>			
$I_F$ (avg)	Continuous Forward Current	50	mA
$I_F$ (pk)	Peak Forward Current (1 $\mu\text{s}$ pulse, 300 pps)	1	A
$V_R$	Reverse Input Voltage	6	V
$P_D$	LED Power Dissipation @ $T_A = 25^\circ\text{C}$	60	mW
	Derate Above $25^\circ\text{C}$	0.6	mW/°C
<b>DETECTOR</b>			
$I_C$	Continuous Collector Current	50	mA
$V_{CEO}$	Collector-Emitter Voltage	80	V
$V_{ECO}$	Emitter-Collector Voltage	7	V
$P_D$	Detector Power Dissipation @ $T_A = 25^\circ\text{C}$	150	mW
	Derate Above $25^\circ\text{C}$	1.5	mW/°C

## Electrical Characteristics

$T_A = 25^\circ\text{C}$

Symbol	Parameter	Test Conditions	Device	Min.	Typ.	Max.	Unit
<b>INDIVIDUAL COMPONENT CHARACTERISTICS</b>							
<b>Emitter</b>							
$V_F$	Forward Voltage	$I_F = 10\text{ mA}$	All	1.0		1.3	V
$I_R$	Reverse Current	$V_R = 5\text{ V}$	All			5	$\mu\text{A}$
<b>Detector</b>							
$BV_{CEO}$	Breakdown Voltage Collector to Emitter	$I_C = 0.5\text{ mA}, I_F = 0$	All	80			V
$BV_{ECO}$	Emitter to Collector	$I_E = 100\text{ }\mu\text{A}, I_F = 0$	All	7			
$I_{CEO}$	Collector Dark Current	$V_{CE} = 80\text{ V}, I_F = 0$	All			100	nA
$C_{CE}$	Capacitance	$V_{CE} = 0\text{ V}, f = 1\text{ MHz}$	All		10		pF
<b>TRANSFER CHARACTERISTICS</b>							
CTR	DC Current Transfer Ratio	$I_F = 5\text{ mA}, V_{CE} = 5\text{ V}$	HMHA281	50		600	%
			HMHA2801	80		600	
			HMHA2801A	80		160	
			HMHA2801B	130		260	
			HMHA2801C	200		400	
$V_{CE(SAT)}$	Saturation Voltage	$I_F = 8\text{ mA}, I_C = 2.4\text{ mA}$	HMHA281			0.4	V
		$I_F = 10\text{ mA}, I_C = 2\text{ mA}$	HMHA2801, HMHA2801A, HMHA2801B, HMHA2801C			0.3	
$t_r$	Rise Time (Non-Saturated)	$I_C = 2\text{ mA}, V_{CE} = 5\text{ V},$ $R_L = 100\text{ }\Omega$	All		3		$\mu\text{s}$
$t_f$	Fall Time (Non-Saturated)	$I_C = 2\text{ mA}, V_{CE} = 5\text{ V},$ $R_L = 100\text{ }\Omega$	All		3		
<b>ISOLATION CHARACTERISTICS</b>							
$V_{ISO}$	Steady State Isolation Voltage	1 Minute	All	3750			$V_{AC(RMS)}$

### Typical Performance Characteristics

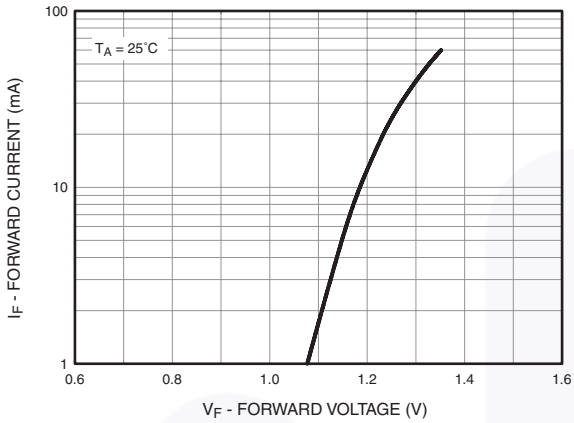

Figure 3. Forward Current vs. Forward Voltage

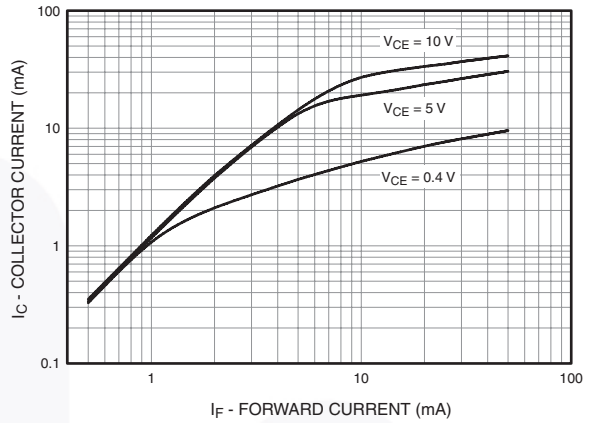

Figure 4. Collector Current vs. Forward Current

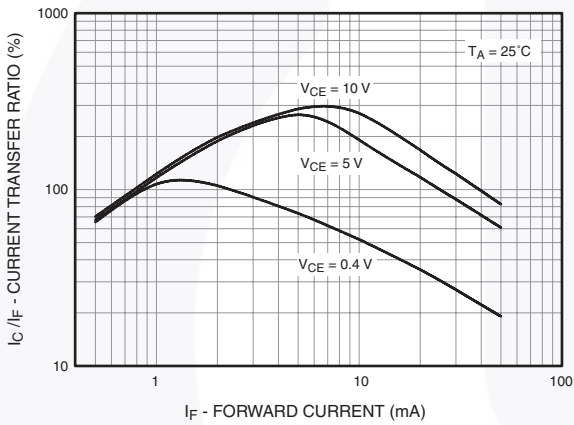

Figure 5. Current Transfer Ratio vs. Forward Current

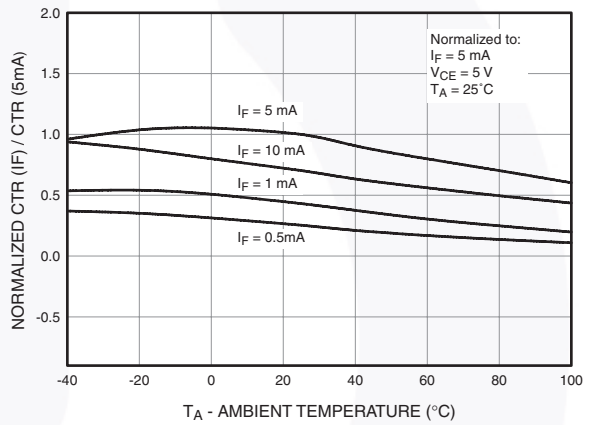

Figure 6. Normalized CTR vs. Temperature

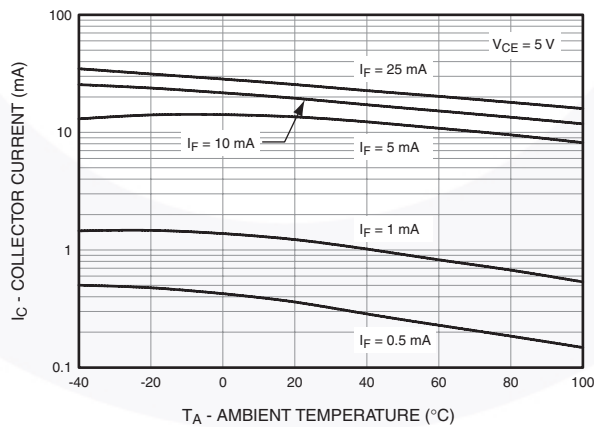

Figure 7. Collector Current vs. Temperature

Typical Performance Characteristics (Continued)

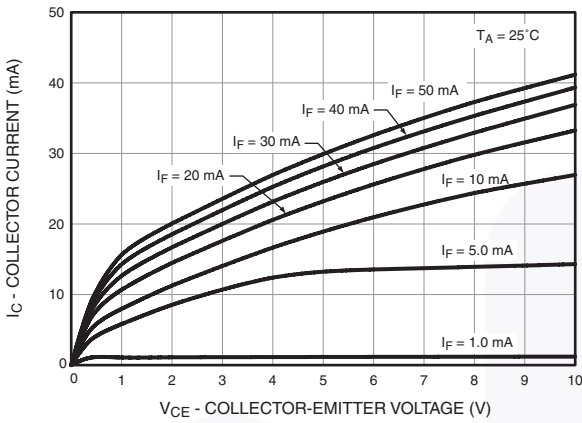

Figure 8. Collector Current vs. Collector-Emitter Voltage

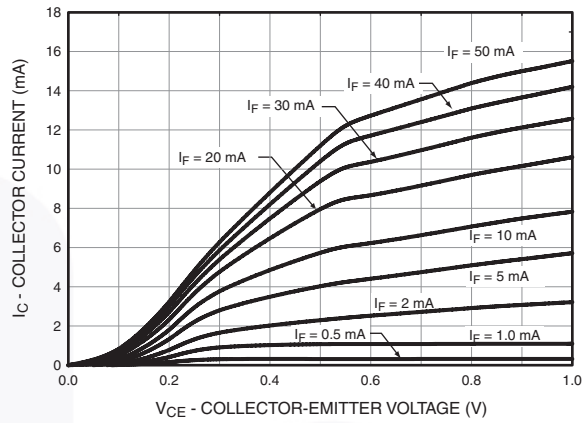

Figure 9. Collector Current vs. Collector-Emitter Voltage

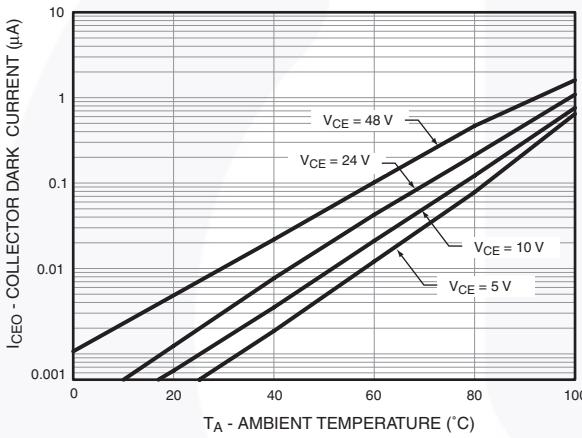

Figure 10. Collector Dark Current vs. Temperature

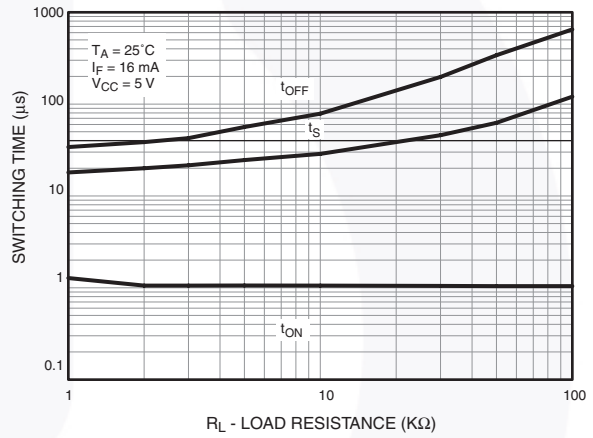

Figure 11. Switching Time vs. Load Resistance

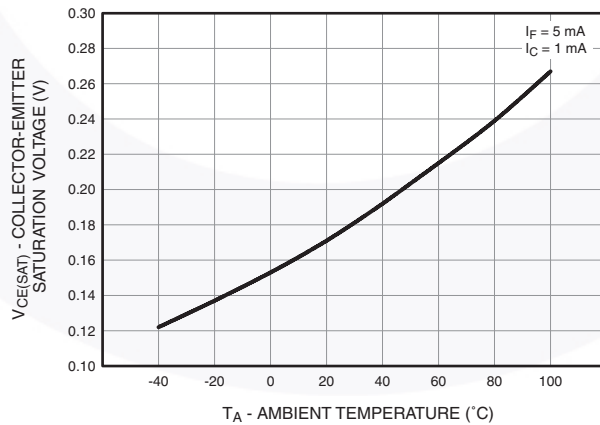
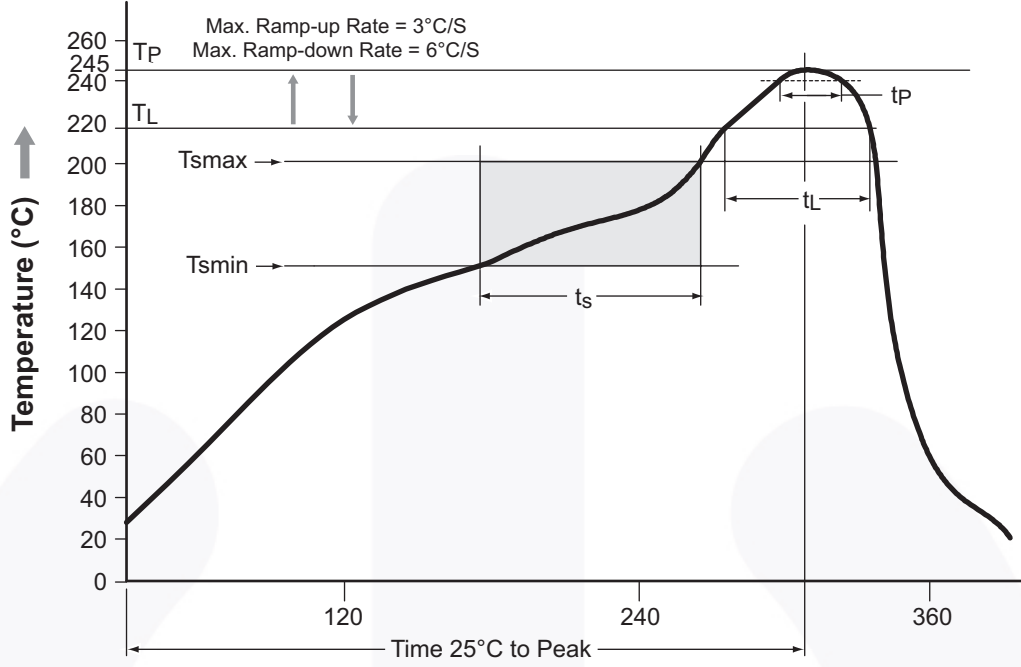

Figure 12. Collector-Emitter Saturation Voltage vs. Temperature

**Reflow Profile**



**Figure 13. Reflow Profile**

Profile Feature	Pb-Free Assembly Profile
Temperature Minimum (T <sub>smin</sub> )	150°C
Temperature Maximum (T <sub>smax</sub> )	200°C
Time (t <sub>s</sub> ) from (T <sub>smin</sub> to T <sub>smax</sub> )	60–120 seconds
Ramp-up Rate (t <sub>L</sub> to t <sub>P</sub> )	3°C/second maximum
Liquidous Temperature (T <sub>L</sub> )	217°C
Time (t <sub>L</sub> ) Maintained Above (T <sub>L</sub> )	60–150 seconds
Peak Body Package Temperature	245°C +0°C / -5°C
Time (t <sub>P</sub> ) within 5°C of 245°C	30 seconds
Ramp-down Rate (T <sub>P</sub> to T <sub>L</sub> )	6°C/second maximum
Time 25°C to Peak Temperature	8 minutes maximum



## Ordering Information

Part Number	Package	Packing Method
HMHA2801	Half Pitch Mini-Flat 4-Pin	Tube (100 units)
HMHA2801R2	Half Pitch Mini-Flat 4-Pin	Tape and Reel (2500 Units)
HMHA2801V	Half Pitch Mini-Flat 4-Pin, DIN EN/IEC60747-5-5 Option	Tube (100 Units)
HMHA2801R2V	Half Pitch Mini-Flat 4-Pin, DIN EN/IEC60747-5-5 Option	Tape and Reel (2500 Units)

**Note:**

2. The product orderable part number system listed in this table also applies to the HMHA281, HMHA2801A, HMHA2801B, and HMHA2801C products.

## Marking Information

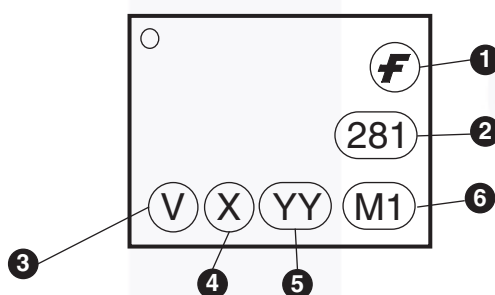
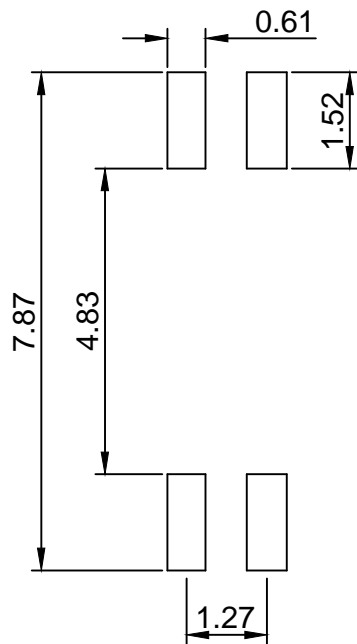
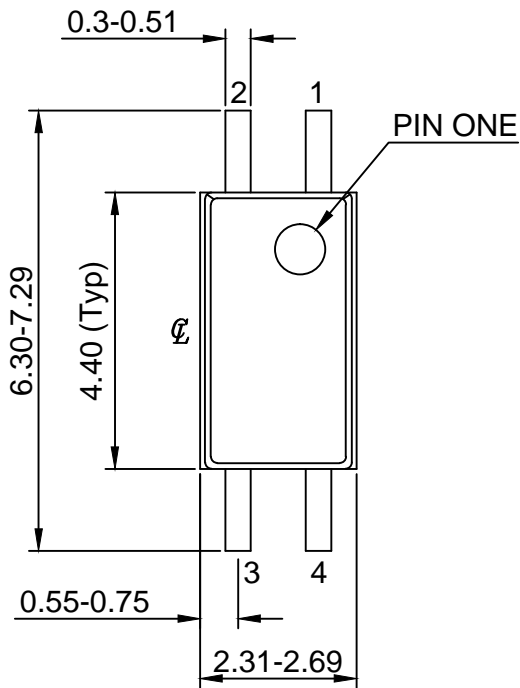

Figure 14. Top Mark

Table 1. Top Mark Definitions

1	Fairchild Logo
2	Device Number
3	DIN EN/IEC60747-5-5 Option (only appears on component ordered with this option)
4	One-Digit Year Code, e.g., “5”
5	Digit Work Week, Ranging from “01” to “53”
6	Assembly Package Code



LAND PATTERN RECOMMENDATION

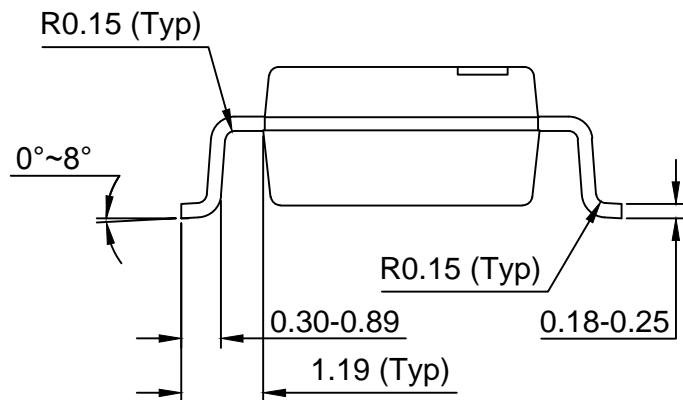
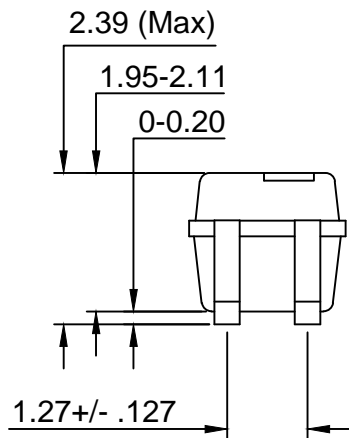

NOTES:

- A) NO STANDARD APPLIES TO THIS PACKAGE
- B) ALL DIMENSIONS ARE IN MILLIMETERS.
- C) DIMENSIONS ARE EXCLUSIVE OF BURRS, MOLD FLASH, AND TIE BAR EXTRUSION
- D) DRAWING FILENAME AND REVISION : MKT-MFP04AREV4.



ON Semiconductor and  are trademarks of Semiconductor Components Industries, LLC dba ON Semiconductor or its subsidiaries in the United States and/or other countries. ON Semiconductor owns the rights to a number of patents, trademarks, copyrights, trade secrets, and other intellectual property. A listing of ON Semiconductor's product/patent coverage may be accessed at [www.onsemi.com/site/pdf/Patent-Marking.pdf](http://www.onsemi.com/site/pdf/Patent-Marking.pdf). ON Semiconductor reserves the right to make changes without further notice to any products herein. ON Semiconductor makes no warranty, representation or guarantee regarding the suitability of its products for any particular purpose, nor does ON Semiconductor assume any liability arising out of the application or use of any product or circuit, and specifically disclaims any and all liability, including without limitation special, consequential or incidental damages. Buyer is responsible for its products and applications using ON Semiconductor products, including compliance with all laws, regulations and safety requirements or standards, regardless of any support or applications information provided by ON Semiconductor. "Typical" parameters which may be provided in ON Semiconductor data sheets and/or specifications can and do vary in different applications and actual performance may vary over time. All operating parameters, including "Typicals" must be validated for each customer application by customer's technical experts. ON Semiconductor does not convey any license under its patent rights nor the rights of others. ON Semiconductor products are not designed, intended, or authorized for use as a critical component in life support systems or any FDA Class 3 medical devices or medical devices with a same or similar classification in a foreign jurisdiction or any devices intended for implantation in the human body. Should Buyer purchase or use ON Semiconductor products for any such unintended or unauthorized application, Buyer shall indemnify and hold ON Semiconductor and its officers, employees, subsidiaries, affiliates, and distributors harmless against all claims, costs, damages, and expenses, and reasonable attorney fees arising out of, directly or indirectly, any claim of personal injury or death associated with such unintended or unauthorized use, even if such claim alleges that ON Semiconductor was negligent regarding the design or manufacture of the part. ON Semiconductor is an Equal Opportunity/Affirmative Action Employer. This literature is subject to all applicable copyright laws and is not for resale in any manner.

## PUBLICATION ORDERING INFORMATION

### LITERATURE FULFILLMENT:

Literature Distribution Center for ON Semiconductor  
19521 E. 32nd Pkwy, Aurora, Colorado 80011 USA  
**Phone:** 303-675-2175 or 800-344-3860 Toll Free USA/Canada  
**Fax:** 303-675-2176 or 800-344-3867 Toll Free USA/Canada  
**Email:** [orderlit@onsemi.com](mailto:orderlit@onsemi.com)

**N. American Technical Support:** 800-282-9855 Toll Free  
USA/Canada  
**Europe, Middle East and Africa Technical Support:**  
Phone: 421 33 790 2910  
**Japan Customer Focus Center**  
Phone: 81-3-5817-1050

**ON Semiconductor Website:** [www.onsemi.com](http://www.onsemi.com)  
**Order Literature:** <http://www.onsemi.com/orderlit>  
For additional information, please contact your local  
Sales Representative

# Mouser Electronics

Authorized Distributor

Click to View Pricing, Inventory, Delivery & Lifecycle Information:

[ON Semiconductor:](#)

[HMHA281V](#) [HMHA281R2V](#) [HMHA281R2](#) [HMHA281](#)



**Стандарт  
Электрон  
Связь**

Мы молодая и активно развивающаяся компания в области поставок электронных компонентов. Мы поставляем электронные компоненты отечественного и импортного производства напрямую от производителей и с крупнейших складов мира.

Благодаря сотрудничеству с мировыми поставщиками мы осуществляем комплексные и плановые поставки широчайшего спектра электронных компонентов.

Собственная эффективная логистика и склад в обеспечивает надежную поставку продукции в точно указанные сроки по всей России.

Мы осуществляем техническую поддержку нашим клиентам и предпродажную проверку качества продукции. На все поставляемые продукты мы предоставляем гарантию .

Осуществляем поставки продукции под контролем ВП МО РФ на предприятия военно-промышленного комплекса России , а также работаем в рамках 275 ФЗ с открытием отдельных счетов в уполномоченном банке. Система менеджмента качества компании соответствует требованиям ГОСТ ISO 9001.

Минимальные сроки поставки, гибкие цены, неограниченный ассортимент и индивидуальный подход к клиентам являются основой для выстраивания долгосрочного и эффективного сотрудничества с предприятиями радиоэлектронной промышленности, предприятиями ВПК и научно-исследовательскими институтами России.

С нами вы становитесь еще успешнее!

**Наши контакты:**

**Телефон:** +7 812 627 14 35

**Электронная почта:** [sales@st-electron.ru](mailto:sales@st-electron.ru)

**Адрес:** 198099, Санкт-Петербург,  
Промышленная ул, дом № 19, литера Н,  
помещение 100-Н Офис 331