

Based on more than 30 years of ceramic and ferrite technology experience, Murata Electronics' full range of leaded EMI filters have been designed to meet today's electronic industry requirements.

Murata's leaded devices consist of ferrite bead inductors, feed-thru capacitors, 3 terminal capacitors, varistor/capacitors common mode chokes and block filters.

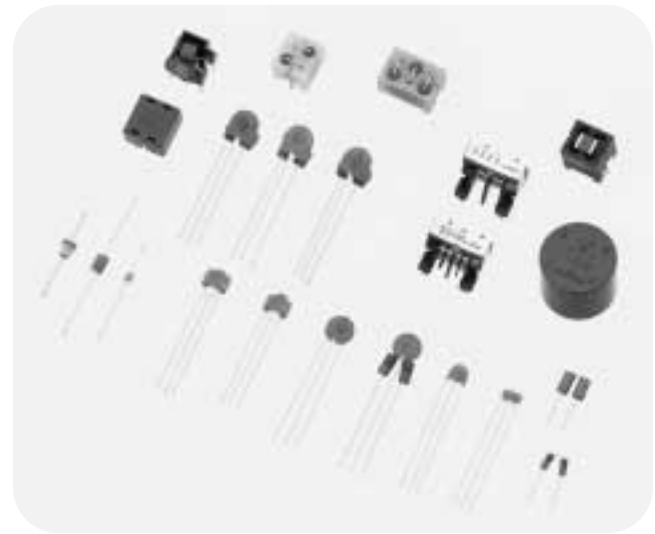
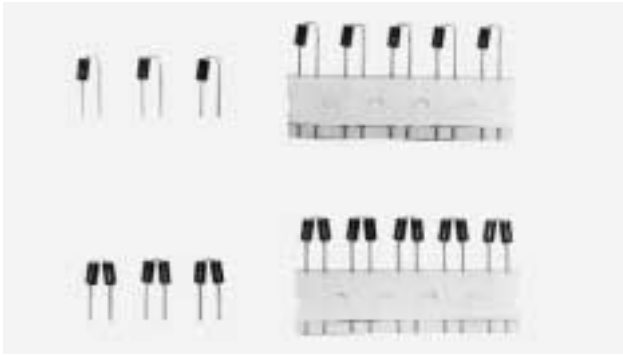

TABLE OF CONTENTS

Description	Series	Effective Frequency (MHz)							Equivalent Circuit	Page
		.1	1	10	100	1000	10000	20000		
Ferrite Bead	BLO		██████████							248 - 249
3-Terminal Capacitor	DS(S)306		██████████							250-251, 254
	DS(S/T)310/H		██████████							252 - 254
3-Terminal Varistor/ Capacitor	VFR303			██████████						255
	DSS706			██████████						256
	DSS710			██████████						257 - 258
Block Filter	BNP			██████████						259
	BNX	██████████								260 - 261
Common Mode Chokes	PLT		██████████							262 - 263
Feed-Thru Capacitor	Sub Mini DF/TF			██████████						264 - 265
	TF318/H/418			██████████						266
NEW EMC Absorber	EA						██████████			267
Ferrite	FS		██████████							268

BL01, BL02 & BL03 Series



Ferrite beads are used for noise suppression in car radios, digital control equipment and for the prevention of spurious oscillation in radio frequency amplifiers. These ferrite bead inductors are devices which can effectively be used on printed circuit boards where high component density is essential. Taped and reeled types are also available for automatic insertion. Radial leaded units can be classified into two types — one using a single ferrite bead and the other using two ferrite beads.

APPLICATIONS

Micro computer, switching regulators, digital control equipment, car radios, car stereos, etc.

FEATURES

- High component density potential
- Double bead BL02RN2 types offered for more effective noise suppression
- Taped and reeled radial and axial types for automatic insertion can be provided as well as ammo packaging.
- Axial lead version BL01RN1-A62 available

PART NUMBERING SYSTEM

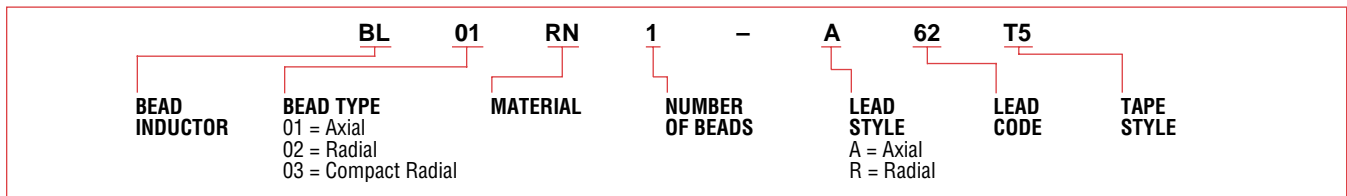

DIMENSIONS: mm

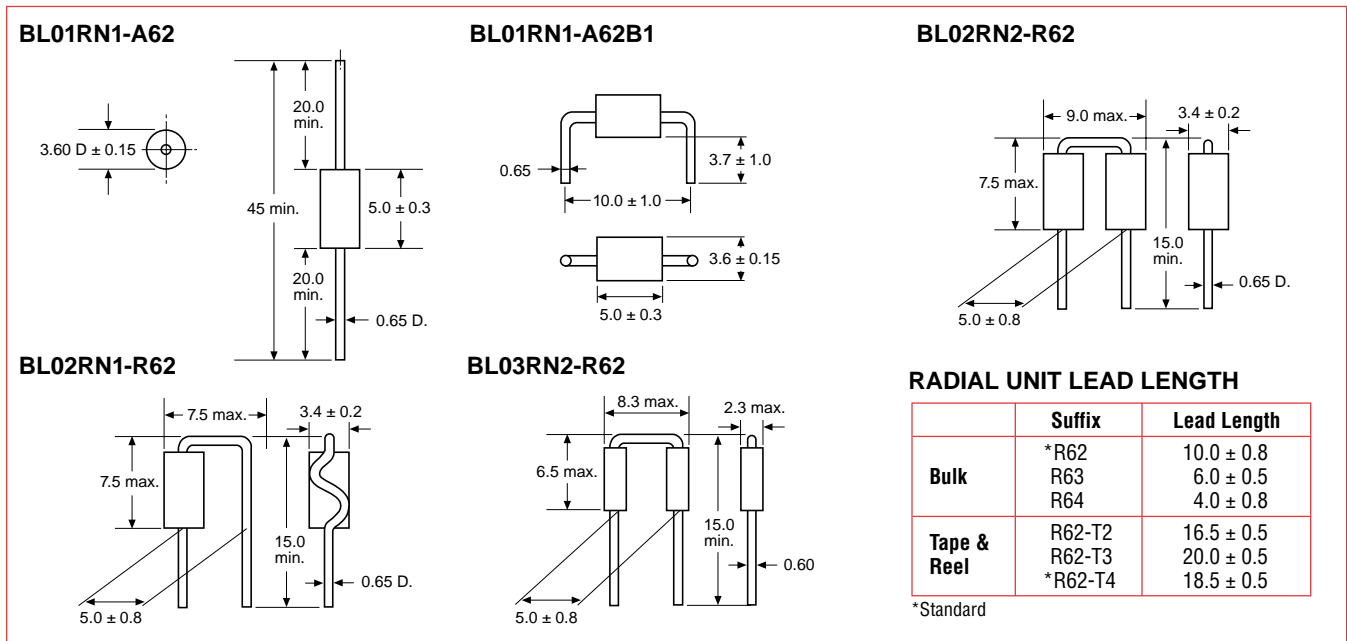

RADIAL UNIT LEAD LENGTH

	Suffix	Lead Length
Bulk	*R62	10.0 ± 0.8
	R63	6.0 ± 0.5
	R64	4.0 ± 0.8
Tape & Reel	R62-T2	16.5 ± 0.5
	R62-T3	20.0 ± 0.5
	*R62-T4	18.5 ± 0.5

*Standard

SPECIFICATIONS

Item	Characteristics
Permeability	(μ i) 550
Saturation Magnetic	(Bs) 3100 (gauss)
Residual Magnetic Flux Density	(Brs) 1700 (gauss)
Coercive Force	(Hc) 0.3 (Oe)
Curie Point	(Tc) 130 (°C)
Temp. Coefficient	($\alpha\mu$ r) 20×10^{-6}
Relative Loss Factor	13×10^{-6}
	0.5 (MHz)
Resistivity	(ρ) 10^7 (Ohms-cm)
Max. Rated Current	BL01 and BL02 (A) (Bulk) 7A
	BL01 and BL02 (A) (Taped) 6A
	BL03 (Taped or Bulk) 6A

CONFIGURATIONS

Part Number	Form
*BL01RN1-A62	Axial, Single bead
*BL01RN1-A62B1	Axial, Single bead, Bent
*BL01RN1-A62T5	Axial, Single bead, Taped
*BL01RN1-A63T6	Axial, Single bead, Taped
*BL02RN1-R62	Radial, Single bead
*BL02RN2-R62	Radial, Double bead
*BL02RN1-R62T4	Radial, Single bead, (Ammo)
*BL02RN2-R62T4	Radial, Double bead, (Ammo)
*BL03RN2-R62	Radial, Double bead
*BL03RN2-R62T4	Radial, Double bead, Ammo

Operating Temperature: -25°C to +85°C

*Available as standard through authorized Murata Electronics Distributors.

TYPICAL IMPEDANCE CHARACTERISTICS

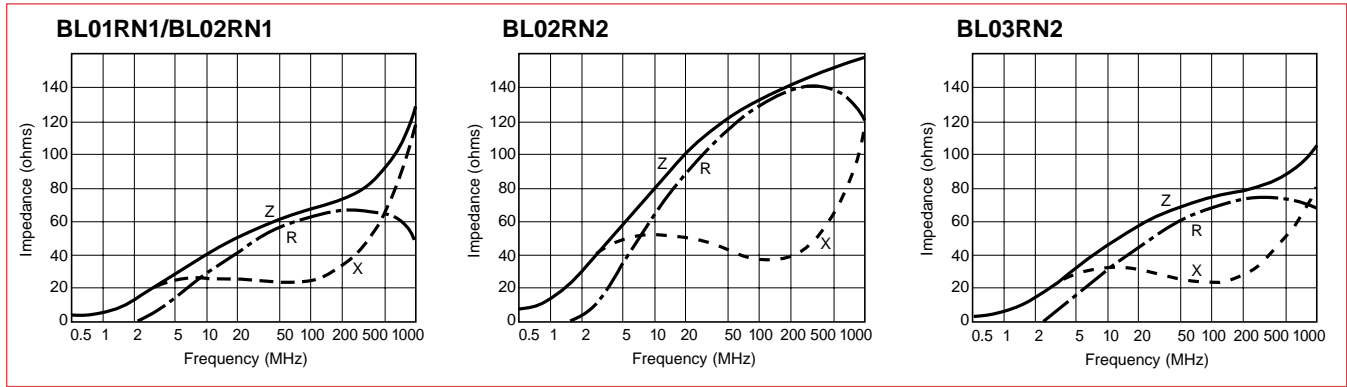

TAPE DIMENSIONS: mm

AXIAL LEAD TYPE BL01 SERIES
BL01RN1-A62T5/A63T6

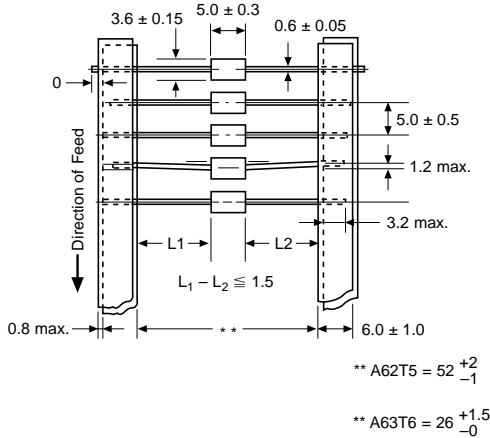

RADIAL LEAD TYPE BL02/BL03 SERIES
BL02RN1-R62T4

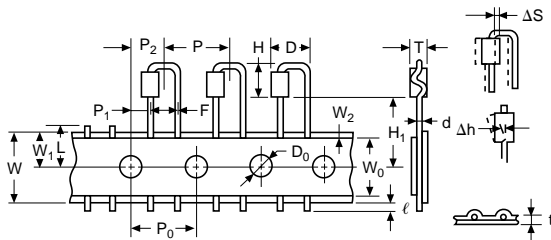

BL02RN2-R62T4/BL03RN2-R62T4

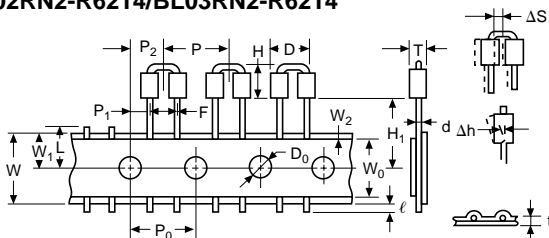

Item	Code	Dimensions: mm
Pitch of Component	P	12.7
Pitch of Sprocket Hole	P ₀	12.7 ± 0.2
Lead Spacing	F	5.0 ^{+0.8} _{-0.2}
Length from Hole Center to Lead	P ₁	3.85 ± 0.7
Length from Hole Center to Component Center	P ₂	6.35 ± 1.3
Width of Body	D	BL02RN1 7.5 max. BL02RN2 9.0 max. BL03RN2 8.3 max.
Height of Bead	H	BL02 7.5 max. BL03 6.5 max.
Deviation along Tape, Left or Right	ΔS	±1.0
Carrier Tape Width	W	18.0 ± 0.5
Position of Sprocket Hole	W ₁	9.0 ⁺⁰ _{-0.5}
Lead Length	H ₁	T2= 16.5 ± 0.5 T3= 20.0 ± 0.5 T4= 18.5 ± 0.5
Protrusion Length	ℓ	+0.5 to -1.0
Diameter of Sprocket Hole	D ₀	4.0 ± 0.1
Lead Diameter	d	0.60 ± 0.5
Total Tape Thickness	t	0.7 ± 0.2
Deviation Across Tape	Δh	±1.0 max.
Portion to Cut in Case of Defect	L	11.0 ⁺⁰ _{-1.0}
Hold Down Tape Width	W ₀	12.0 ± 0.5
Hold Down Tape Position	W ₂	1.5 ± 1.5
Body Thickness	T	BL02 3.4 ± 0.2 BL03 2.3 max.

EMI LEADED FILTERS

EMI SUPPRESSION FILTER

COMPACT DISC-TYPE

DS306 & DSS306 Series

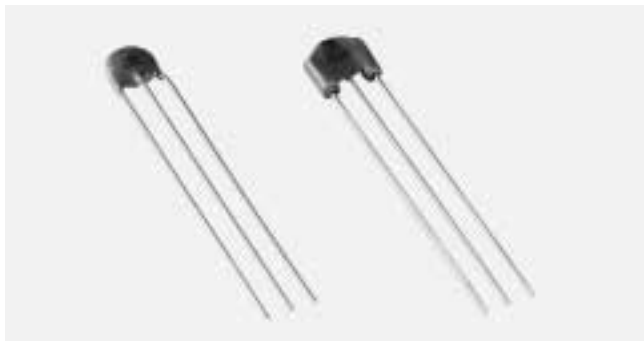

APPLICATIONS

- Computer and peripherals interfaces
- Compact digital equipment
- Compact PPC, electronic typewriters, other electronic equipment and appliances
- Helps all electronic equipment and appliances meet FCC, VDE and CISPR regulations
- STD footprint for high density mounting

PART NUMBERING SYSTEM

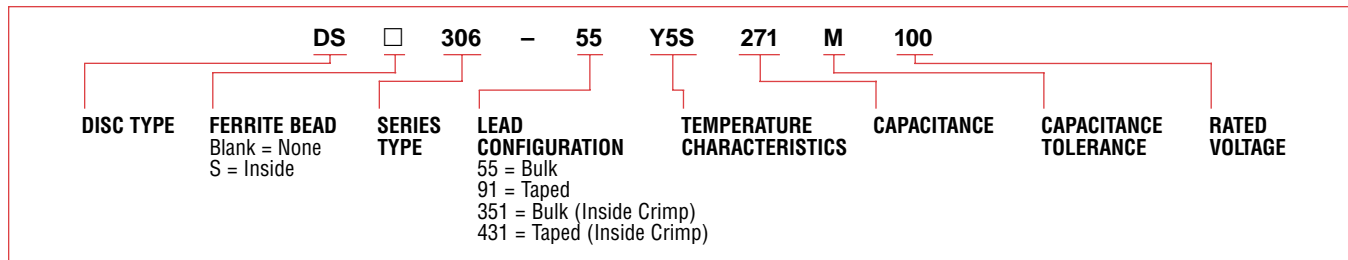

SPECIFICATIONS

Part Number	Capacitance	Capacitor		Ferrite Beads	Dimensions	Insertion Loss
		W.V.	T.C. -25 to +85°C			
*DS306-55Y5S220M50	22pF ± 20%	50VDC	±22%	None	Fig. 1	Fig. 4
*DS306-55Y5S330M50	33pF ± 20%		±22%			
*DS306-55Y5S470M50	47pF ± 20%		±22%			
*DS306-55Y5S101M50	100pF ± 20%		±22%			
*DS306-55Y5S271M50	270pF ± 20%		±22%			
*DS306-55Y5S102M50	1000pF ± 20%		±22%			
*DS306-55Y5S222M50	2200pF ± 20%		±22%			
*DS306-55FZ103Z50	10000pF + 80%, -20%		+30%, -85%			
*DSS306-55Y5S220M100	22pF ± 20%	100VDC	±22%	Internal	Fig. 2	Fig. 5
*DSS306-55Y5S330M100	33pF ± 20%		±22%			
*DSS306-55Y5S470M100	47pF ± 20%		±22%			
*DSS306-55Y5S101M100	100pF ± 20%		±22%			
*DSS306-55Y5S151M100	150pF ± 20%		±22%			
*DSS306-55Y5S221M100	220pF ± 20%		±22%			
*DSS306-55Y5S271M100	270pF ± 20%		±22%			
*DSS306-55Y5S471M100	470pF ± 20%		±22%			
*DSS306-55Y5S102M100	1000pF ± 20%		±22%			
*DSS306-55Y5U222Z100	2200pF + 80%, -20%					
*DSS306-55FZ103N100	10000pF ± 30%		+30%, -85%			
*DSS306-55F223Z16	22000pF + 80%, -20%	16VDC	+30%, -80%			
*DSS306-351Y5S220M100	22pF ± 20%	100VDC	±22%	Internal	Fig. 3	Fig. 6
*DSS306-351Y5S330M100	33pF ± 20%		±22%			
*DSS306-351Y5S470M100	47pF ± 20%		±22%			
*DSS306-351Y5S101M100	100pF ± 20%		±22%			
*DSS306-351Y5S151M100	150pF ± 20%		±22%			
*DSS306-351Y5S221M100	220pF ± 20%		±22%			
*DSS306-351Y5S271M100	270pF ± 20%		±22%			
*DSS306-351Y5S471M100	470pF ± 20%		±22%			
*DSS306-351Y5S102M100	1000pF ± 20%		±22%			
*DSS306-351Y5U222Z100	2200pF + 80%, -20%					
*DSS306-351FZ103N100	10000pF ± 30%		+30%, -85%			
*DSS306-351F223Z16	22000pF + 80%, -20%	16VDC	+30%, -80%			

Note: "55" in part number denotes Bulk packaging. For Taped Product, replace with appropriate number from chart on page 254. All units are rated 6 amp.
* Available as standard through authorized Murata Electronics Distributors.

EMI LEADED FILTERS

EMI SUPPRESSION FILTER

COMPACT DISC-TYPE

DS306 & DSS306 Series

DIMENSIONS: mm

DS306-55 Series
Fig. 1

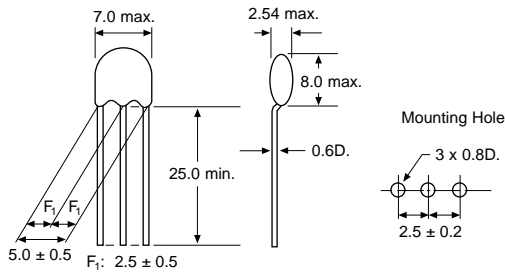

DSS306-55 Series
Fig. 2

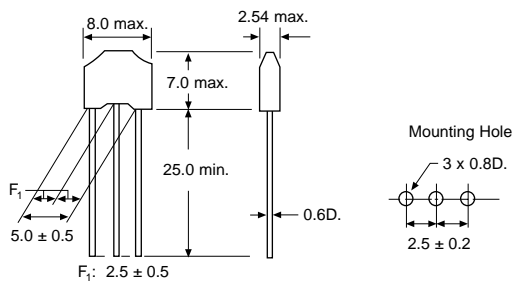

DSS306-351 Series
Fig. 3

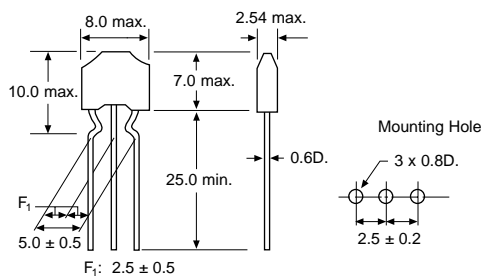

TYPICAL INSERTION LOSS CHARACTERISTICS

DS306-55 Series
Fig. 4

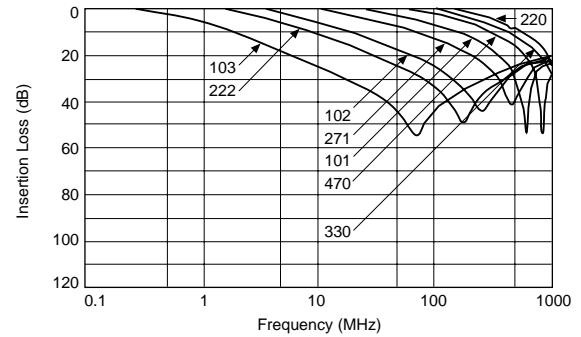

DSS306-55 Series
Fig. 5

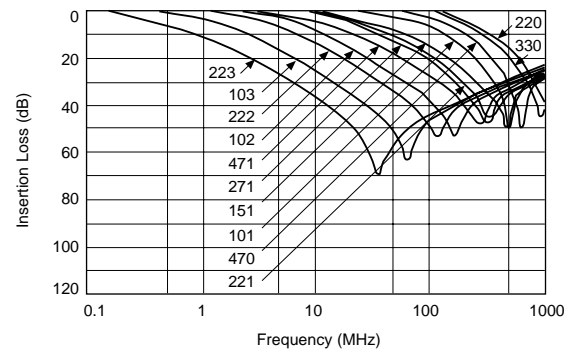

DSS306-351 Series
Fig. 6

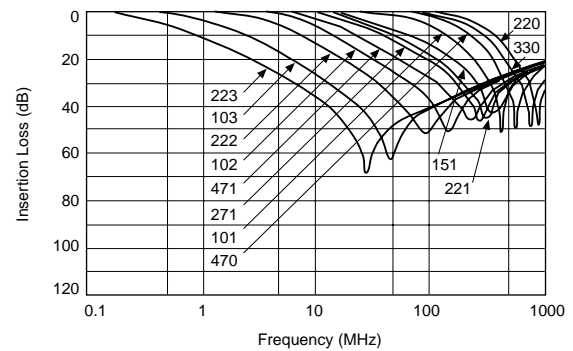

EMI LEADED FILTERS EMI SUPPRESSION FILTERS DISC-TYPE

DS310/H, DST310/H & DSS310/H Series

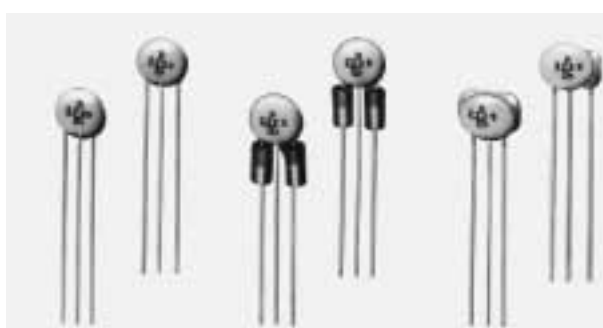

Disc-type EMIFIL® DS310, DST310 and DSS310 are T-type EMI suppression filters. The disc-type EMIFIL increases the self-resonant frequency of the capacitor by attaching two lead wires to one of the electrodes of the capacitor and increases the insertion loss by adding inductance to the lead in the DST and DSS types only. Frequencies to be suppressed can be selected by choosing the capacitance. They are also recommended for use as by-pass capacitors.

PART NUMBERING SYSTEM

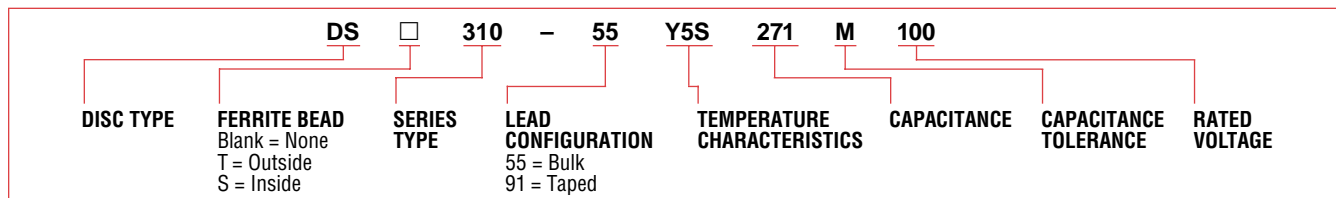

SPECIFICATIONS

Part Number	Capacitance	Capacitor		Ferrite Beads	Dimensions	Insertion Loss
		W.V.	T.C. -25°C to +85°C			
FOR GENERAL APPLICATIONS						
*DS310-55Y5S271M100	270pF ± 20%	100V	±22%	None	Fig. 1	Fig. 4
*DS310-55Y5S222M100	2200pF ± 20%	100V				
*DS310-55Y5S223S50	22000pF + 50%, -20%	50V				
*DS310-55Y5S104M16	100000pF ± 20%	16V				
*DST310-55Y5S271M100	270pF ± 20%	100V	±22%	External	Fig. 2	Fig. 5
*DST310-55Y5S222M100	2200pF ± 20%	100V				
*DST310-55Y5S223S50	22000pF + 50%, -20%	50V				
*DSS310-55Y5S220M100	22pF ± 20%	100V	±22%	Internal	Fig. 3	Fig. 6
*DSS310-55Y5S470M100	47pF ± 20%	100V				
*DSS310-55Y5S101M100	100pF ± 20%	100V				
*DSS310-55Y5S271M100	270pF ± 20%	100V				
*DSS310-55Y5S222M100	2200pF ± 20%	100V				
*DSS310-55Y5S223S50	22000pF + 50%, -20%	50V				
FOR AUDIO CIRCUITS (LOW DISTORTION TYPE)						
*DSS310-55BL222M100	2200pF ± 20%	100V	±10%	Internally	Fig. 3	Fig. 9
*DSS310-55DL223S50	22000pF + 50%, -20%	50V	+20%, -30%			

Part Number	Capacitance	T.C.		Ferrite Beads	Dimensions*	Insertion Loss
		-25°C to +85°C	-40°C to +105°C			
FOR HIGH TEMPERATURE APPLICATIONS						
*DS310H-55B220M250	22pF ± 20%	±10%	±20%	None	Fig. 1	Fig. 7
*DST310H-55B220M250				External	Fig. 2	Fig. 8
*DSS310H-55B220M250				Internal	Fig. 3	Fig. 10
*DS310H-55B101M250	100pF ± 20%			None	Fig. 1	Fig. 7
*DST310H-55B101M250				External	Fig. 2	Fig. 8
*DSS310H-55B101M250				Internal	Fig. 3	Fig. 10
*DS310H-55B271M250	270pF ± 20%	None	Fig. 1	Fig. 7		
*DST310H-55B271M250		External	Fig. 2	Fig. 8		
*DSS310H-55B271M250		Internal	Fig. 3	Fig. 10		
*DS310H-55B222M250	2200pF ± 20%	±30%	±20%	None	Fig. 1	Fig. 7
*DST310H-55B222M250				External	Fig. 2	Fig. 8
*DSS310H-55B222M250				Internal	Fig. 3	Fig. 10

*Note: DS□310 Series Footprint for Bulk and Tape & Reel are different. Consult your local Murata Electronics Sales Office. All DS□310H units are rated at 7A max. and 250VDC. Current rating is 7Amps for bulk packaged units, 6Amps for tape and reel.

*Available as standard through authorized Murata Electronics Distributors.

DIMENSIONS: mm (See Note)

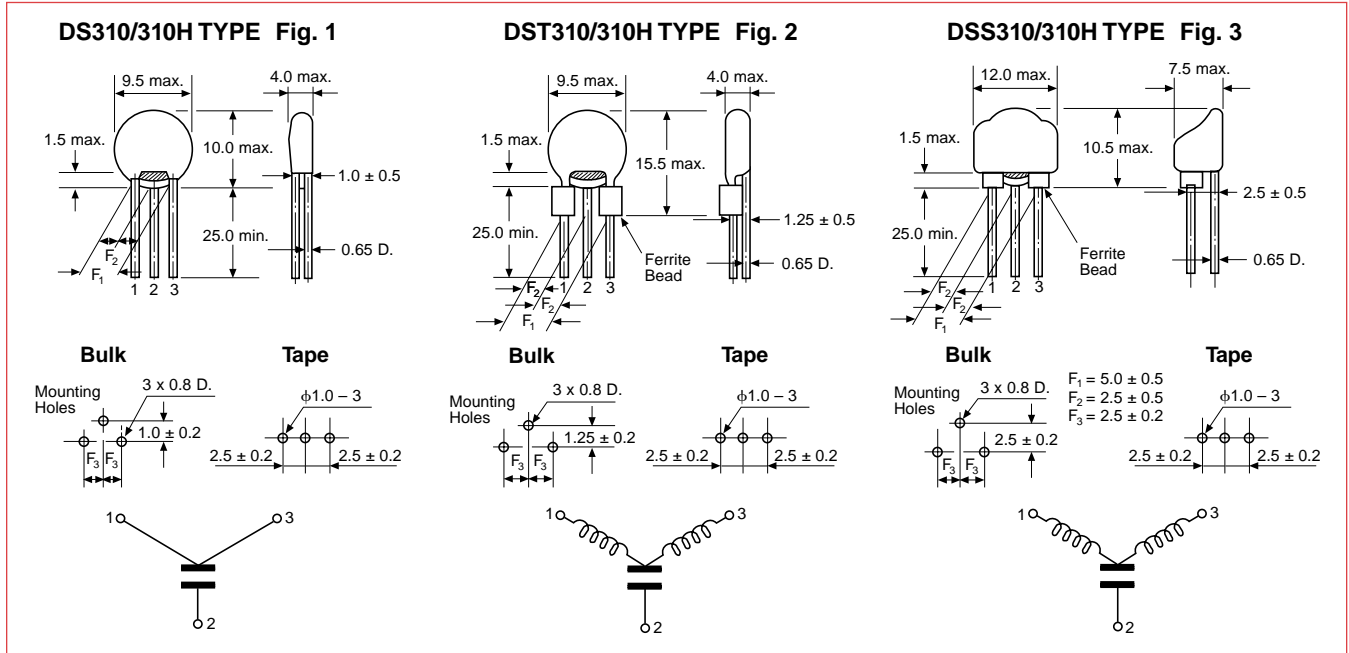

Note: DS□310 Series Footprint for Bulk and Tape are different.
Consult your local Murata Electronics Sales Office for details.

TYPICAL INSERTION LOSS CHARACTERISTICS

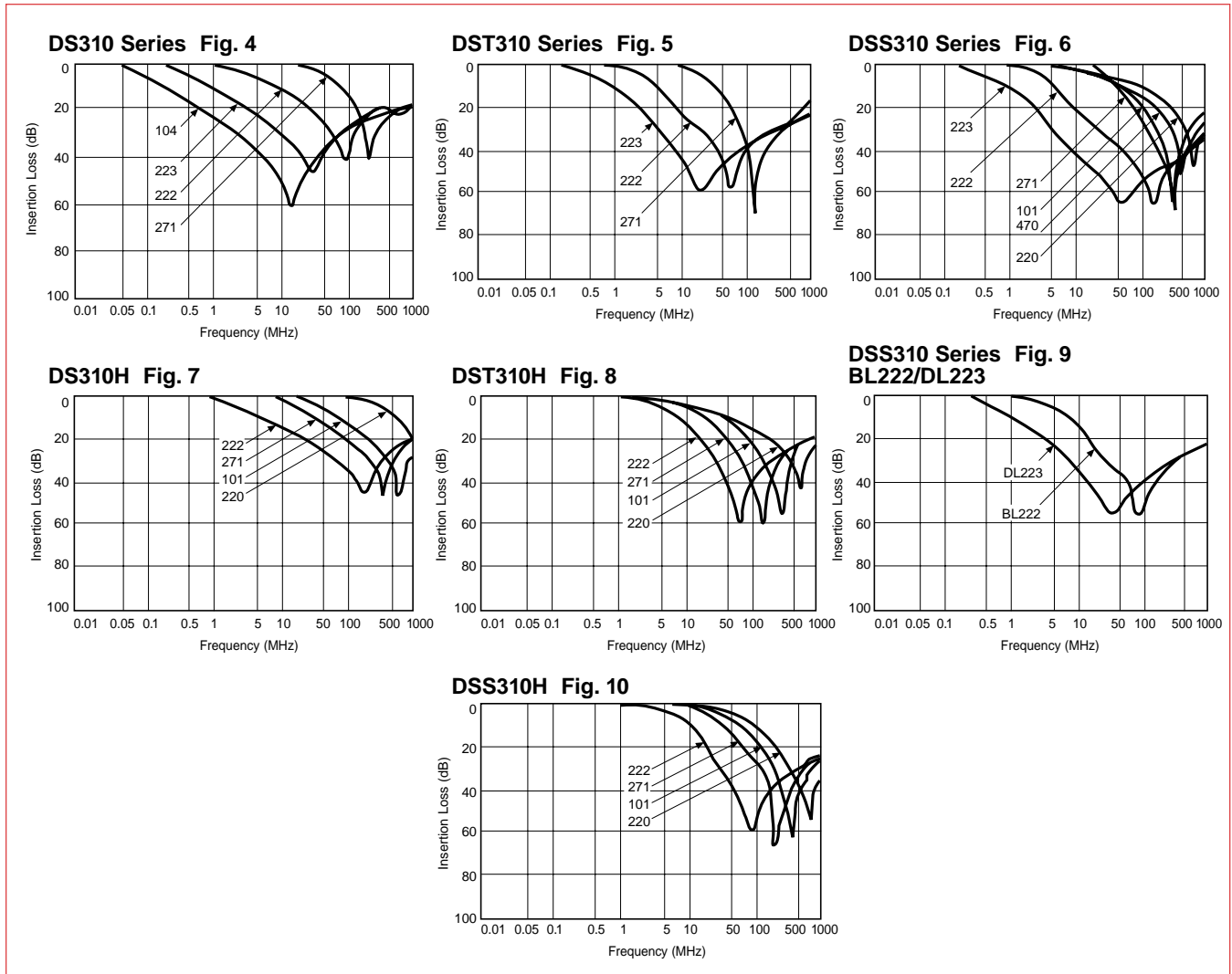

EMI LEADED FILTERS EMI SUPPRESSION FILTERS TAPE & REEL

DS□306, DS□310/310H Series

PART NUMBERING, DS306 & DSS310 SERIES

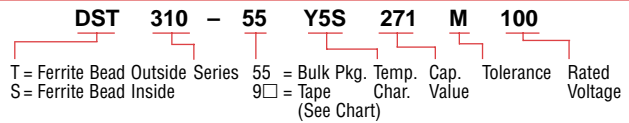

TAPING CODES

Code		H
Straight Leads	Crimped Leads	Tape & Reel
91	—	20.0
92	421	16.5
93	431	18.5

*Three types of H dimensions (lead length) are available for various types of insertion machines.

TAPE DIMENSIONS: mm

DS306-91 Type DS310-91 Type

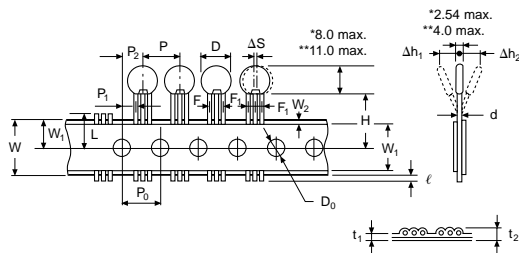

DSS310-91 Type

(Taping for DSS type is only DSS310-91 Type)

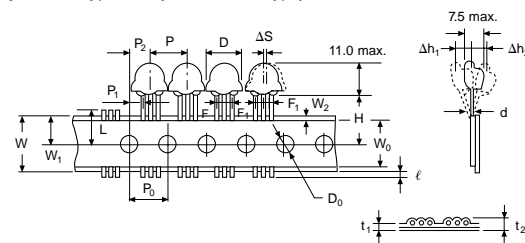

DST310-91 Type

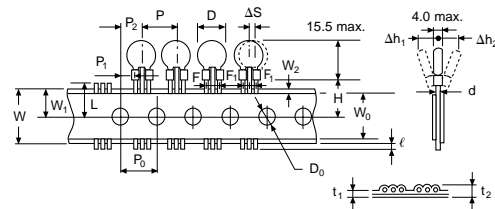

DSS306-91 Type

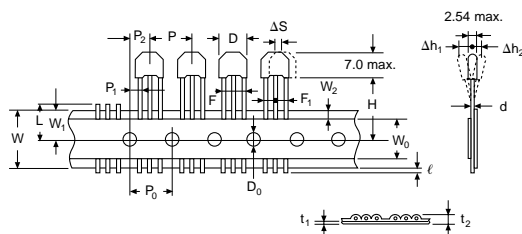

DSS306-431 Type

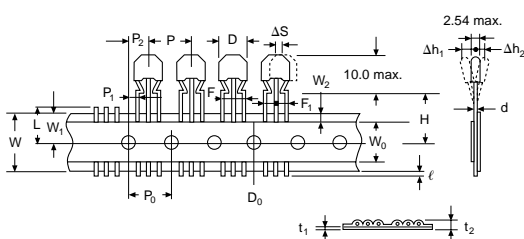

Item	Code	Dimensions: mm	Remarks
Taping Pitch	P	12.7	Product Inclination ΔS Determines Tolerance
Guide Pitch	P ₀	12.7 ± 0.2	
Hole Center to Lead	P ₁	3.85 ± 0.7	
Hole Center to Component Center	P ₂	6.35 ± 1.3	Shift in Tape in Direction of Feed
Diameter of Body	D	7.0 [9.5]	DS max. [].....
		8.0 [9.5]	DST max. DS□310
		8.0 [12]	DSS max. Series
Deviation of Body Center	ΔS	0 ± 1.0	
Width of Base Tape	W	18.0 ± 0.5	
Feed Hole Position to Capacitor Lead	W ₁	9.0 ⁺⁰ _{-0.5}	Tape Widthwise Shift
Protrusion Length	ℓ	+0.5 to -1.0	
Diameter of Feed Hole	D ₀	4.0 ± 0.1	
Diameter of Lead	d	0.6	
Total Thickness of Tape	t ₁	0.7 ± 0.2	Includes Thickness of Bonding Tape
	t ₂	1.5 max.	
Deviation Across Tape	Δh ₁	1.0 max.	
	Δh ₂	1.0 max.	
Length of Snipped Lead	L	11.0 ⁺⁰ _{-1.0}	
Width of Hold Position	W ₀	12.0 ± 0.5	
Hold-down Tape Position	W ₂	1.5 ± 1.5	
Lead Distance Between Reference and Bottom Planes	H	18.5 ± 1.0	16.5 & 20.0mm Lengths are also available
Lead Spacing	F	5.0 ^{+0.8} _{-0.2}	
	F ₁	2.5 ^{+0.4} _{-0.2}	

PACKAGING TYPE AND NUMBERS

Part Number	Quantity (Pcs.)	
	Flat Pack	Reel
DS□306 Series	2000	—
DS310/310H Series	2000	—
DST310/310H Series	—	1000*
DSS310/310H Series	—	800

※ Non Standard

EMI LEADED FILTERS EMI SUPPRESSION FILTERS WITH SEMICONDUCTOR SURGE PROTECTION



The VFR303 Series is an EMI suppression filter with a built-in varistor function designed to protect semiconductors, such as C-MOS and TTI, from ESD surge rushes. The VFR303 series works well as EMI suppression filter.

FEATURES

- Absorbs ESD surges, provides IC protection.
- Excellent signal line EMI suppression filter.
- Thin and low height enables high density mounting.

APPLICATIONS

Elimination of noise and protection of semiconductors in office automation equipment, including computers and their peripheral equipment, copy machines, and communication terminals.

PART NUMBERING SYSTEM

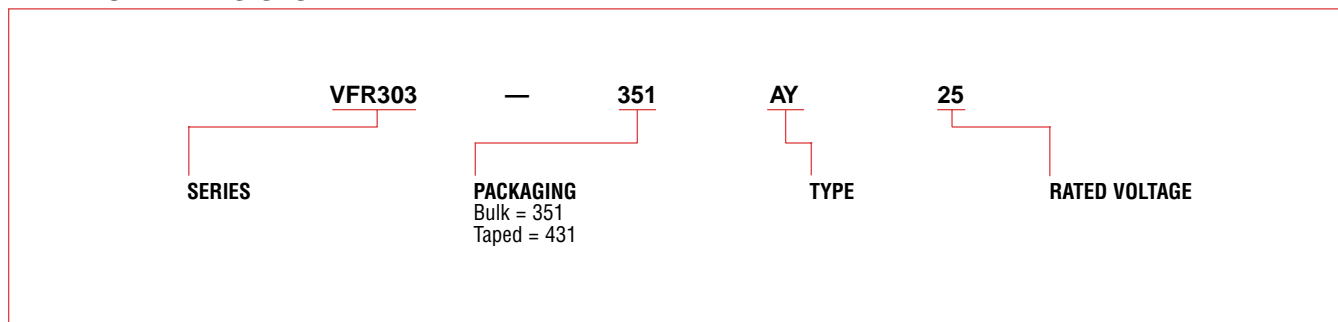

DIMENSIONS: mm

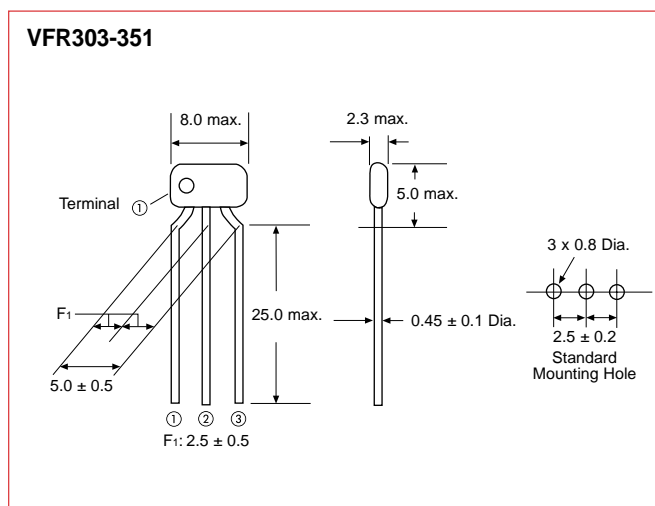

TYPICAL INSERTION LOSS CHARACTERISTICS (50 Ohms – 3K Ohms)

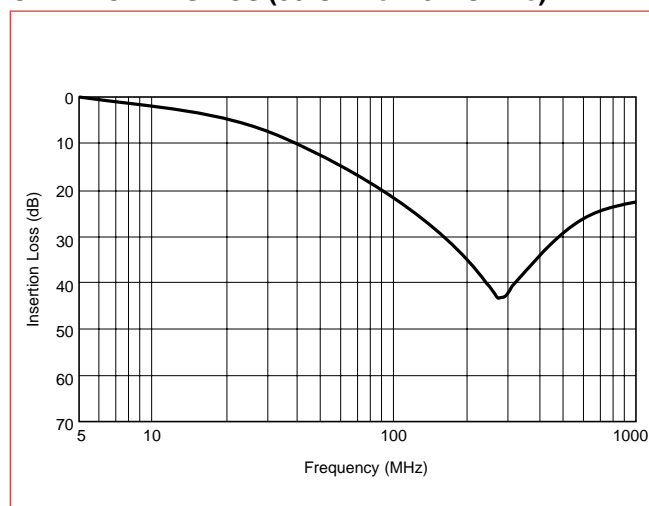

SPECIFICATIONS

Part Number	Capacitance (1kHz) (Between Terminals 1-2)	DC Resistance (Ohms) (Between Terminals 1-3)	Rated Voltage (Between Terminals 1-2)	Rated Current (Between Terminals 1-3)	Varistor Voltage	Peak Pulse Current (Between Terminals 1-2) 8/20μs	Operating Temp. Range
★VFR303-351 AY 25	130pF ± 20%	150 ± 35%	25VDC	20mA	50VDC ± 20% (V1mA)	15A	-25 to +85°C

* Available as standard through authorized Murata Electronics Distributors.



The DSS706 Varistor-Capacitor is a three-terminal filter which suppresses noise emission from electronic equipment while controlling incoming surges of static electricity. Its small size enables 2.5mm pitch mounting.

APPLICATIONS

Elimination of noise and protection of semiconductors in office automation equipment, including computers, peripheral equipment, copy machines, and communication terminals.

FEATURES

- Protects circuits from electrical surges and acts as a filter for signal lines.
- Effectively suppresses high-frequency noise from signal lines. (Performance equivalent to conventional three-terminal capacitor.)
- Small size enables it to be mounted at 2.5mm pitch. Three-terminal structure leads to superior high-frequency characteristics.
- Built-in ferrite bead provides excellent EMI suppression.

PART NUMBERING SYSTEM

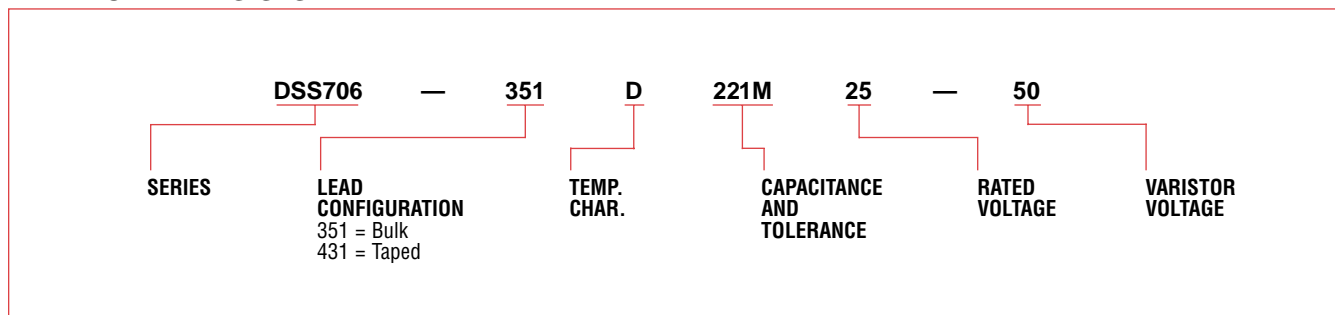

DIMENSIONS: mm

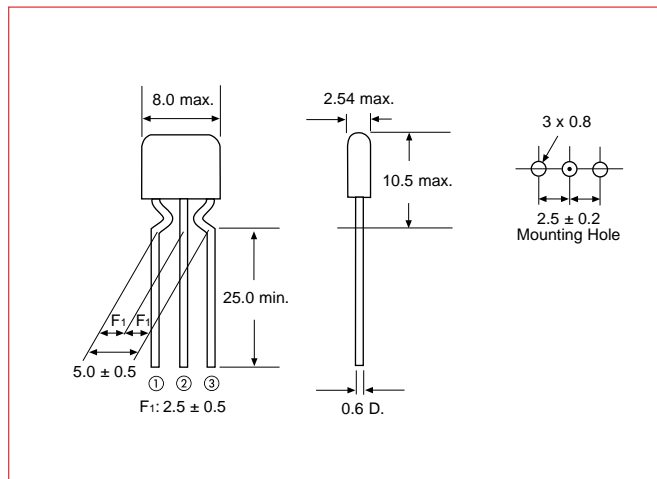

TYPICAL INSERTION LOSS CHARACTERISTICS

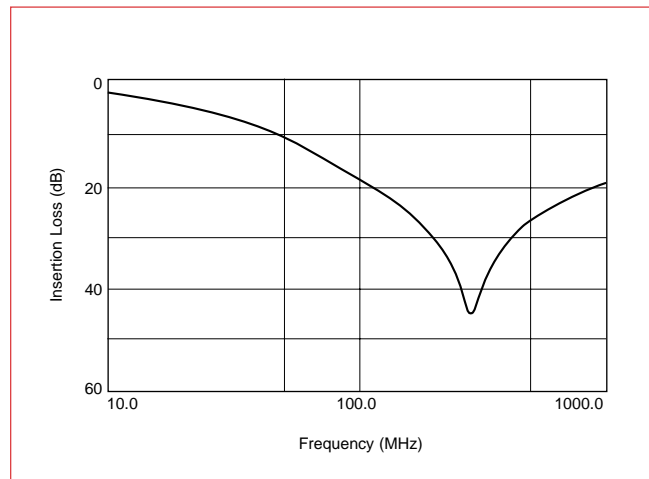

SPECIFICATIONS

Part Number	Capacitance	Capacitance Temp. Char.	Rated Voltage	Max. Rated Current	Varistor Voltage	Peak Pulse Current	Operating Temp. Range
★DSS706-351D221M25-50	220pF ± 20%	+20%, -30%	25VDC	6 Amps	50 ± 20%	100A	-40 to +105°C

★Available as standard through authorized Murata Electronics Distributors.

EMI LEADED FILTERS EMI SUPPRESSION FILTERS VARISTOR-CAPACITOR

DSS710 Series

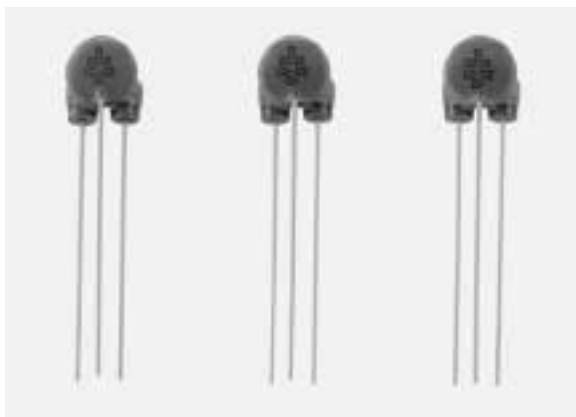

The DSS710 uses a capacitor element which provides the varistor function. This varistor-capacitor not only works as a bypass capacitor but also lets high-voltage surges flow to ground.

The varistor-capacitor used in the DSS710 has a 3-lead structure, so that its high frequency functions are substantially better than those of conventional capacitors. Furthermore, it is combined with ferrite bead to form a T-shaped filter circuit that most effectively suppresses EMI.

The DSS710 efficiently removes fast-rising transients and high-frequency EMI above 50 or 60 MHz which conventional capacitors and varistor-capacitors are incapable of removing.

Varistor-capacitors are used even where conventional EMI-filters fail. They are self-healing and effective in circuits having 500-600V impulses.

PART NUMBERING SYSTEM

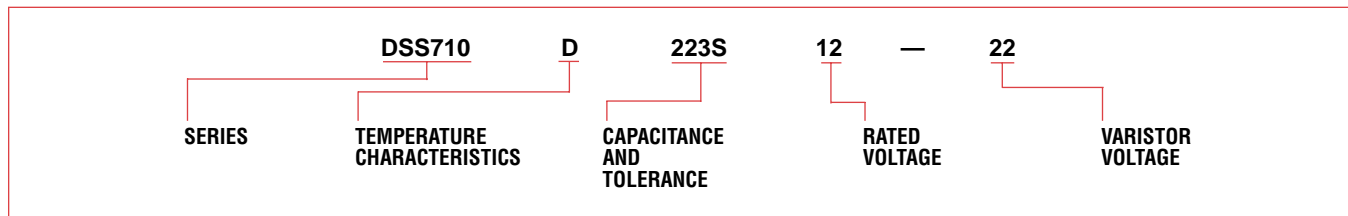

DIMENSIONS: mm

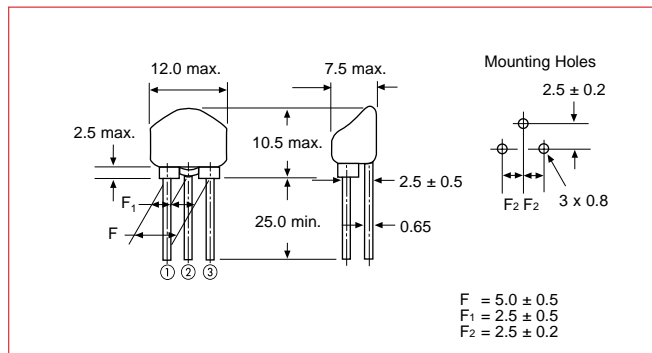

Note: Footprint for Bulk and Tape & Reel are different. Consult your local Murata Electronics Sales Office.

TYPICAL INSERTION LOSS CHARACTERISTICS

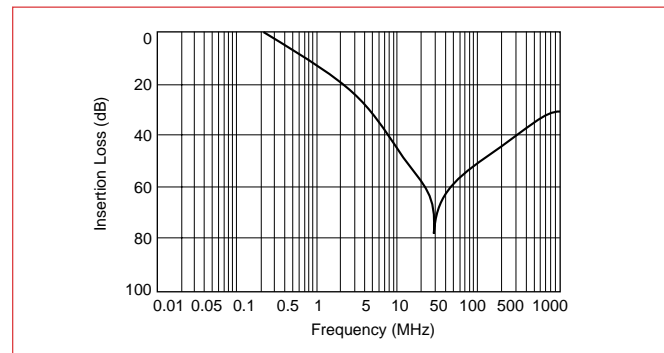

SPECIFICATIONS

Part Number	★DSS710 D223 S 12-22
Capacitance	22000pF $\pm 50\%$ / -20%
DF	5.0% max.
Insulation Resistance	1M Ohms min.
Ic (max.)	7 A
Rated Voltage	12VDC
Varistor Voltage	22VDC $\pm 20\%$ (V1mA)
Voltage Nonlinear Factor	1.25 max. (V10mA/V1mA)
Temperature Characteristics	$\pm 20\%$ / -30% (-25°C to +85°C)
Operating Temperature Range	-40°C to +100°C
Inductance	0.8 μ H x 2 (1kHz)

*Available as standard through authorized Murata Electronics Distributors.

VOLTAGE – CURRENT CURVE

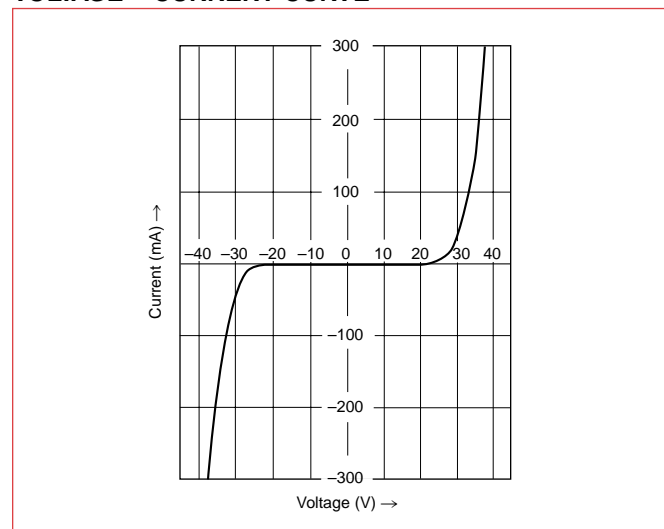

3-TERMINAL STRUCTURE

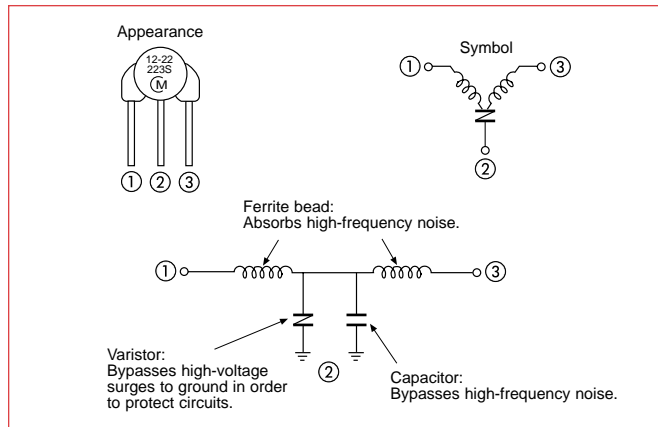

The reason the 3-terminal structure provides excellent high frequency characteristics.

Bypass capacitors should logically be able to remove more noise as frequency increases. In actual fact, the electrodes and lead wires of the capacitor have series inductance as shown in Fig. 3, and this causes an LC resonance when the frequency is between 1MHz and 50MHz. As a result, when the frequency is higher than the self-resonance frequency, the noise suppression capability of the bypass capacitor is drastically reduced because the capacitor functions as inductor. To solve this problem, the DSS series has one side of the capacitor electrodes connected to two lead wires. This eliminates the series inductance to the capacitor. Furthermore, a ferrite bead is attached to each lead wire to form a T-shaped filter, thus providing efficient noise suppression.

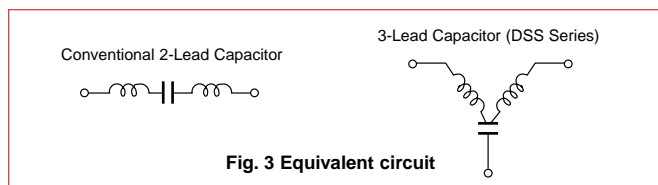

Fig. 3 Equivalent circuit

NOISE ABSORPTION EFFECT OF VARISTOR-CAPACITOR

The top waveform shows a sharp, high-amplitude surge. The bottom waveform shows a significantly reduced and smoothed surge after passing through the Varistor-Capacitor.

SCALE:
 ⬆ 200V/Div.
 ⬆ 10NS/Div.

Waveform when a Varistor-Capacitor is not used (surge from a noise simulator).

Varistor-Capacitor is used to suppress the surge shown below

Waveform after the noise passes through a Varistor-Capacitor. Protection of circuitry is achieved.

The Varistor-Capacitor is capable of removing even 1200V surges and will withstand 2000V impulses.

APPLICATIONS

Systems	Lines to be connected to	Effects
Engine Controllers	Power lines, I/O for low-frequency current	Protection of systems from excessive voltage. Prevents ignition noise, lightning surges, etc. from causing malfunctions.
Automobile Audio Equipment	Power lines, audio output lines	Protection of system from excessive voltage. Prevents ignition noise from influencing audio current.
Computers	Power lines, I/O lines for low-frequency current	Protection of systems from excessive voltage. Prevents radiation and conduction noise.
DC Motors	Power lines	Prevention of brush noise.

EMI LEADED FILTERS EMI SUPPRESSION FILTERS BLOCK FILTERS

BNP002/004 Series



Block-type BNP002 filters completely eliminate noise from extremely wide frequency bands. The BNP002 is ideal for eliminating noise in logic signal circuits and is designed to perform superbly through the use of through-type barrier layer capacitors, and bead inductors.

Each block contains a number of compact EMI suppression filters. In addition, the input/output terminals and the grounding terminal are aligned in the same direction, thus permitting fast and easy assembly on any type of PC board.

FEATURES

- The EMIFIL BNP002 incorporates feed-thru type barrier layer capacitors in Pi circuits, obtaining significantly large insertion losses over an extremely wide frequency range — from 15MHz up to 1GHz.
- The cut-off frequency is designed to be at several MHz, which is ideal for eliminating noise from any circuit in which the signal frequency and the noise frequency are relatively close together.

APPLICATIONS

Noise elimination from signal lines and DC power sources in engine control units, digital equipment and computer terminals.

- Since all noise in parallel signal lines can be eliminated by one filter block, minimum board space is utilized.
- There are no connections in the feed-thru current circuits, thus ensuring highly reliable performance.
- Both the input/output terminals and the grounding terminal are aligned in the same direction, permitting fast and easy installation on any type of PC board.

DIMENSIONS: mm

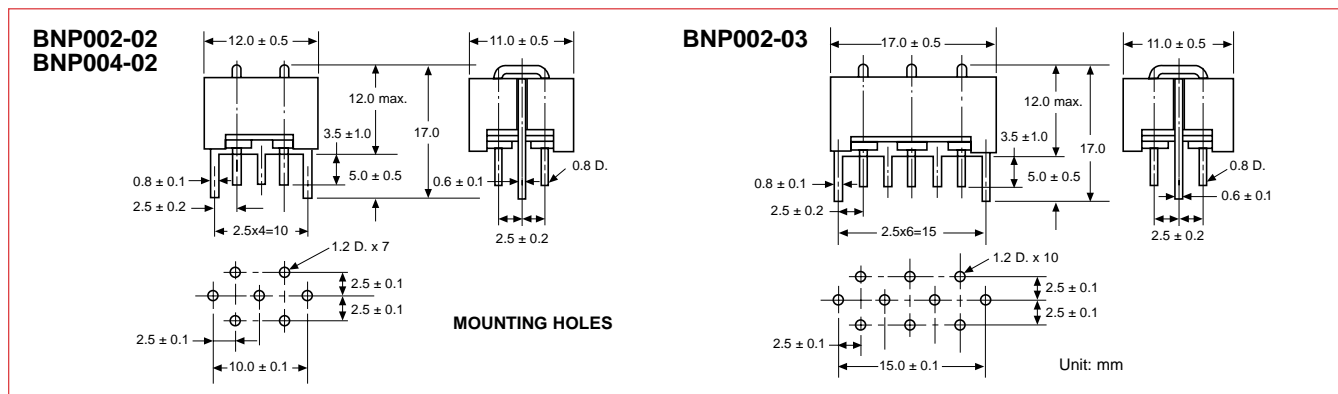

SPECIFICATIONS

Item	Specifications		
Part Number	★BNP002-02	★BNP002-03	★BNP004-02
Number of Circuits	2	3	2
Circuit Construction	π		
Operating Temperature Range	-40°C to +100°C		
Rated Voltage	50VDC		
Withstand Voltage	300VDC	125VDC	
Maximum Current Capacity	10ADC		
Insulation Resistance	1000M Ohms min.		
DC Resistance	0.05 Ohms max., (20°C to 25°C)		
Insertion Loss	20MHz to 500MHz: 40dB (20°C to 25°C) min.		300MHz to 1GHz: 40dB min.

RECOMMENDED P.C. BOARD PATTERN

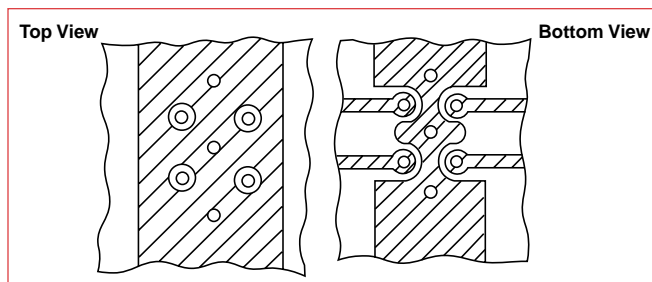

EQUIVALENT CIRCUIT

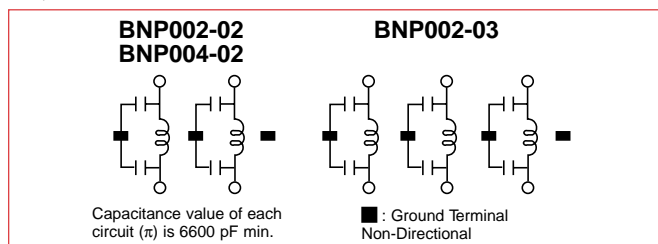

TYPICAL INSERTION LOSS CHARACTERISTICS

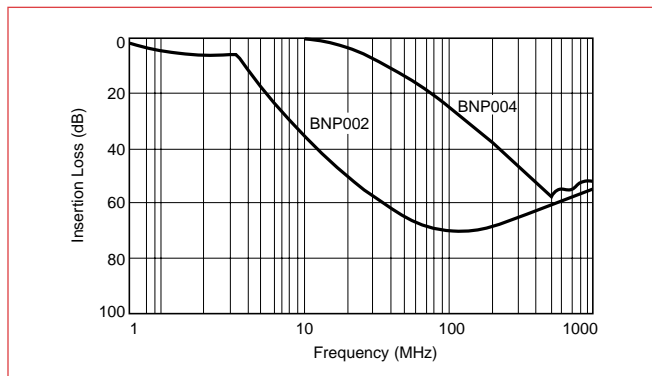

*Available as standard through authorized Murata Electronics Distributors.

EMI LEADED FILTERS EMI SUPPRESSION FILTERS BLOCK FILTERS



BNX002/003/005 Series



Block-type BNX002 filters completely eliminate noise from extremely wide frequency bands. The BNX002 is perfect for use in DC power circuits and is designed to perform superbly—through the use of through-type barrier layer capacitors, monolithic chip capacitors and bead inductors.

Each block contains a number of compact EMI suppression filters. In addition, the input/output terminals and the grounding terminal are aligned in the same direction, thus permitting fast and easy assembly on any type of PC board.

APPLICATIONS

Noise elimination from signal lines and DC power sources in a variety of switching power sources, engine control units, digital equipment and computer terminals.

FEATURES

- The BNX002 incorporates feed-thru-type barrier layer capacitor and a chip capacitor which are interconnected. This combination enables the BNX002 to achieve a significantly large insertion loss throughout the extremely wide frequency range of 0.5MHz to 1GHz, which covers the AM and UHF-TV broadcast frequency bands.
- Non polarized—but care must be taken to ensure that terminal with inductor on ground line faces EMI source.

- The filter is extremely compact since only one filter block is needed to completely eliminate noise from both the positive and ground lines.
- There are no connections in the feed-thru current circuits, thus ensuring highly reliable performance.
- Both the input/output terminals and the grounding terminal are aligned in the same direction, permitting fast and easy installation on any type of PC board.

DIMENSIONS: mm

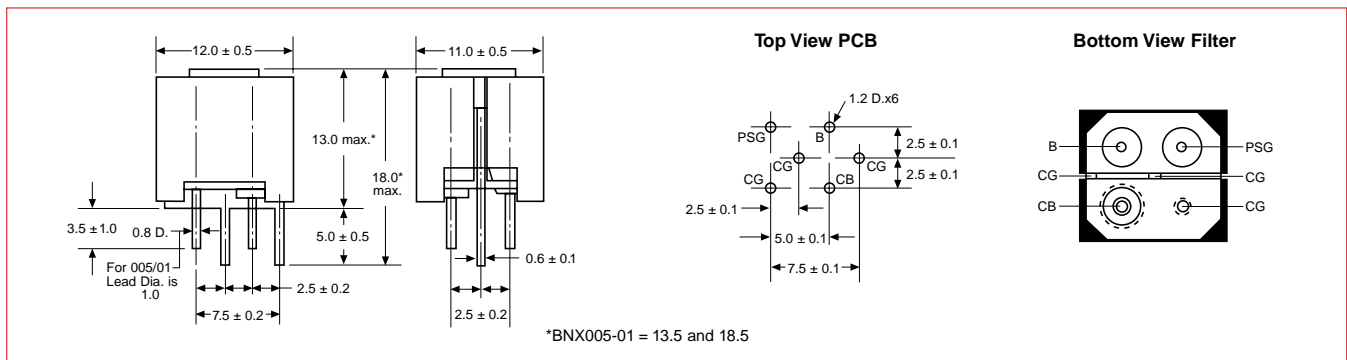

SPECIFICATIONS

Item	Specifications		
Part Number	★BNX002-01	★BNX003-01	★BNX005-01
Operating Temperature Range	-30°C to +85°C		
Rated Voltage	50VDC	150VDC	50VDC
Test Voltage	125VDC	375VDC	125VDC
Maximum Current Capacity	10ADC		15ADC
Insulation Resistance	1000M Ohms min.		
Insertion Loss	1MHz to 1GHz 40dB min.	5MHz to 1GHz 40dB min.	1MHz to 1GHz 40dB min.
	20°C to 25°C Line Impedance = 50 Ohms		

EQUIVALENT CIRCUIT

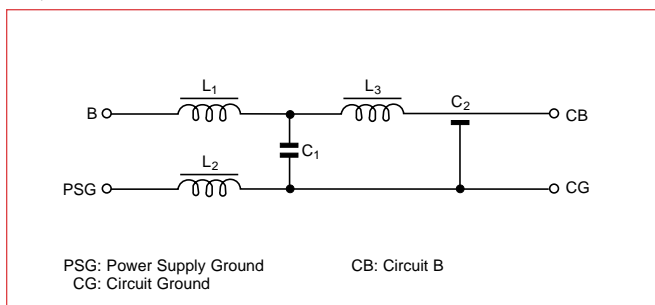

RECOMMENDED P.C. BOARD PATTERN

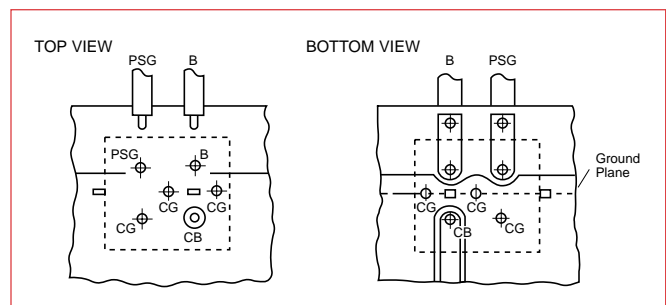

*Available as standard through authorized Murata Electronics Distributors.

EMI LEADED FILTERS EMI SUPPRESSION FILTERS BLOCK FILTERS

BNX002/003/005 Series

USING THE BNX SERIES EFFECTIVELY

The block type filter effectively prevents unwanted reflections and external noise from entering the equipment circuitry and power lines by grounding all the high frequency components which make up the noise.

To maximize performance, proper grounding is required. To insure proper grounding, observe the following points:

- When designing the PC board, use all the available grounding terminals and arrange the circuit to maximize the area of the ground pattern.

- Minimize the distance between the PC board ground and the filter's grounding plate.
- Insert the filter into the PC board up to the terminal roots.
- Do not externally connect PSG to CG.

APPLICATION

- Suppression of DC side ripple of the switching power supply

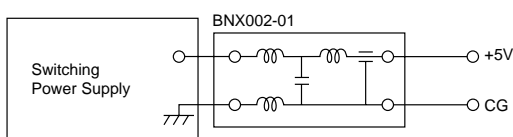

- When BNX002 is not used

(High frequency noise, max. 0.5V, can be seen.)

+5.0V→
50μs/DIV
0.2V/DIV



- When BNX002 is used

(Noise can be almost eliminated by BNX002.)

+5.0V→
50μs/DIV
0.2V/DIV

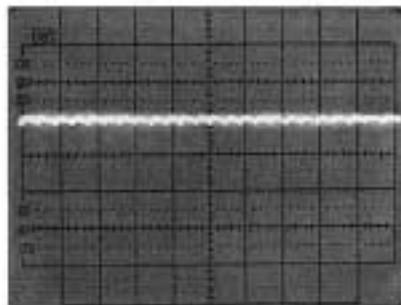

TYPICAL INSERTION LOSS CHARACTERISTICS

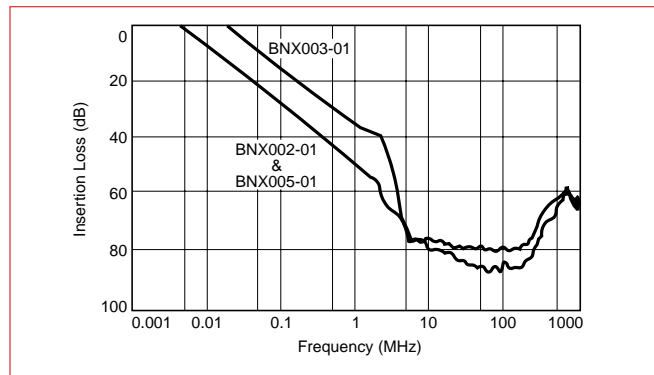

EMI LEADED FILTERS

EMI SUPPRESSION FILTERS

DC COMMON MODE CHOKE COIL

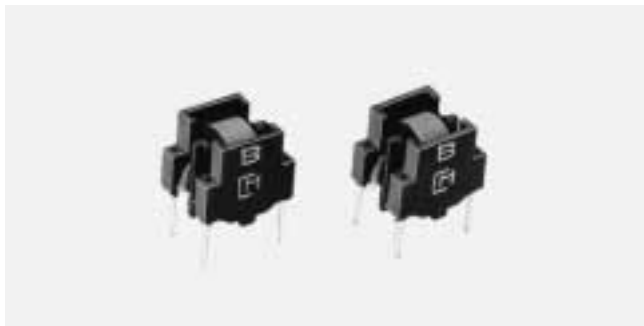

Compact, lightweight, common mode choke coil for DC power supplies for common mode noise suppression from several MHz to several hundred MHz.

FEATURES

- Ideal for suppression of common mode noise in high frequencies ranging from several MHz to several hundred MHz.
- PCB mount type makes mounting simple.
- Only negligible influence on 10MHz high frequency signals (PLT0R53C only).

APPLICATIONS

To meet FCC regulations on digital equipment such as computers and computer terminal equipment.

To meet VDE regulations on hand-held digital appliances using AC adapters (suppression of unwanted radiation from power cords).

Suppression of radiated noise from cable between AC adapters and sets.

DIMENSIONS: mm

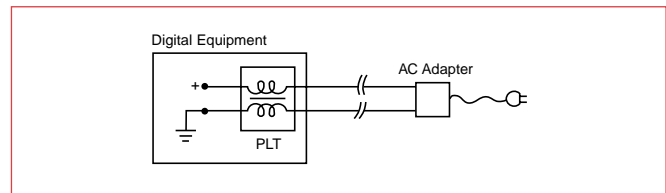
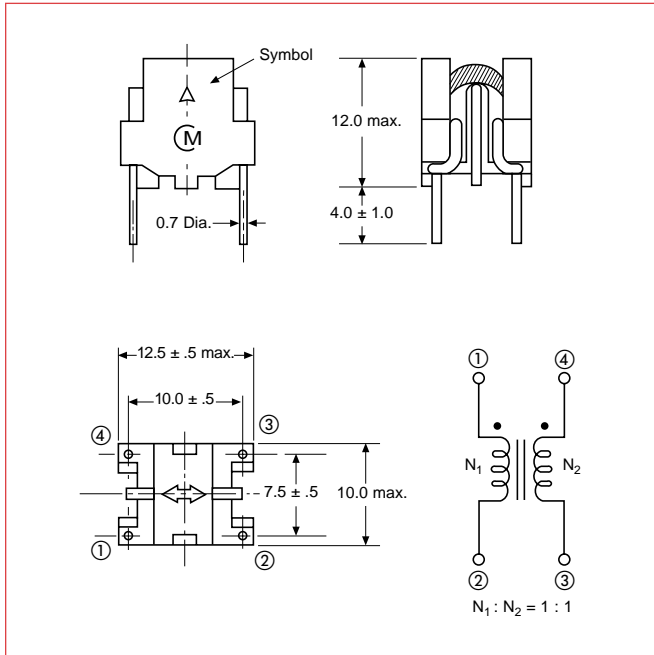

Suppression of radiated noise from DC power supply and interface cables.

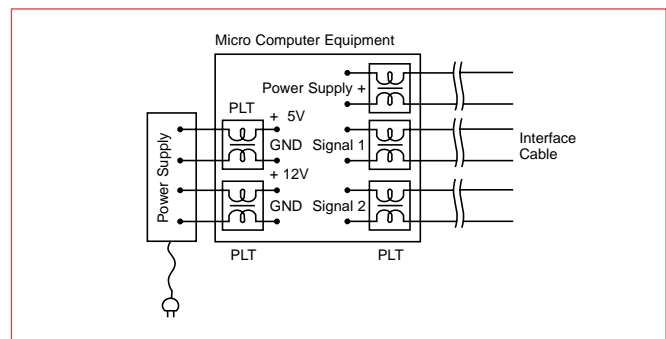

PART NUMBERING SYSTEM

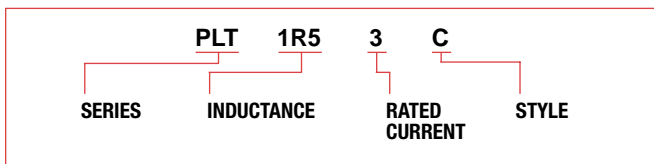

TYPES

Part Number	Inductance (μH) min.	Self-resonance Frequency (MHz)*	Marking Code
★PLT0R53C	0.5	1000 min.	B
★PLT1R53C	1.5	250	A
★PLT2003C	20.0	10	C

*Typical Value

SPECIFICATIONS

Item	Rating
Rated Voltage	50VDC
Rated Current	3A
Withstand Voltage	125VDC (1 to 5 seconds)
Operating Temp. Range	-25°C to +60°C

*Available as standard through authorized Murata Electronics Distributors.

TYPICAL INSERTION LOSS CHARACTERISTICS

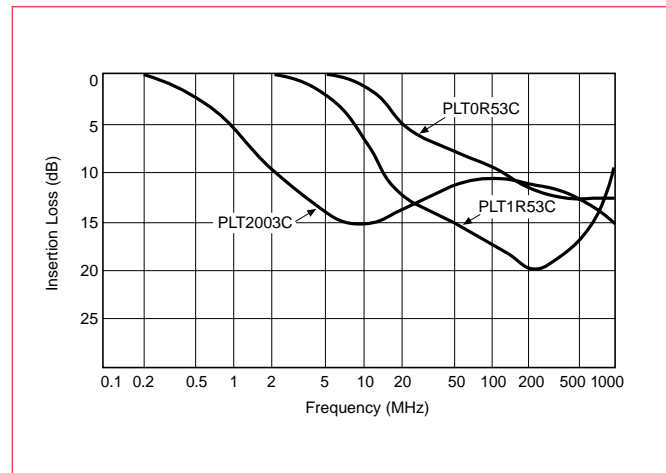

EMI LEADED FILTERS NOISE FILTERS DC COMMON MODE CHOKE COIL



FEATURES

- Extended self-resonant frequency
- Meets FCC, CISPR, VCCI noise requirements
- High current rating – 3A max.
- High density mounting

APPLICATIONS

Switching power supplies, digital equipment, CTV, VCR, ECR and other electronic equipment and appliances.

DIMENSIONS: mm

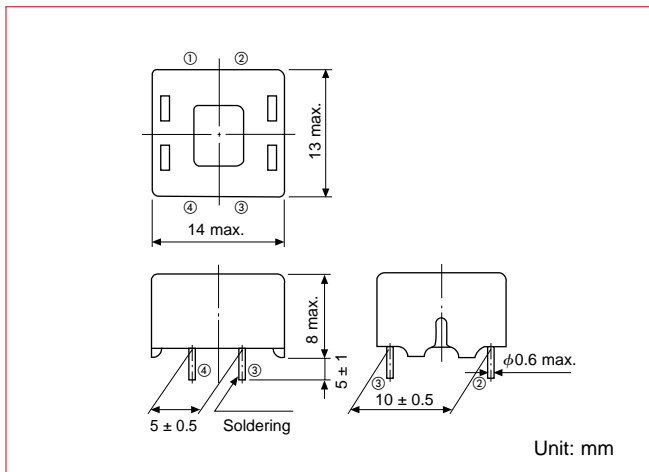

CIRCUIT DIAGRAM

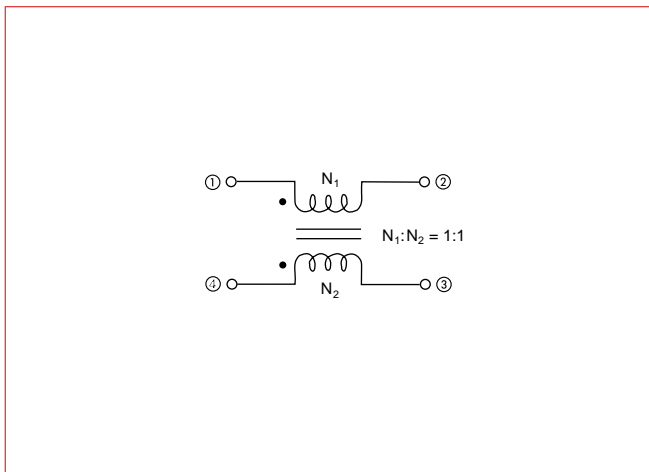

SPECIFICATIONS

Rated Voltage	50VDC
Withstand Voltage (between coils)	125VDC (1 min.)
Rated Current (Amps)	3.0
Insulation Resistance	10M Ohms min. (100VDC 1 minute)
DC Resistance Ohms max.	0.03
Inductance min.	20μH
Operating Temperature Range	-40°C to +85°C
Temperature Char. (Inductance)	20°C ⁺⁸⁰ / ₋₅₀ % (-25°C ~ +60°C)

PART NUMBERING SYSTEM

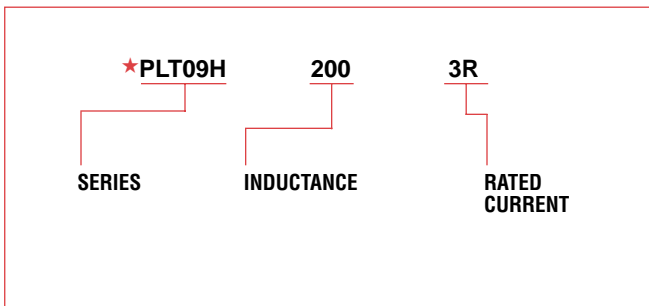

TYPICAL INSERTION LOSS CHARACTERISTICS

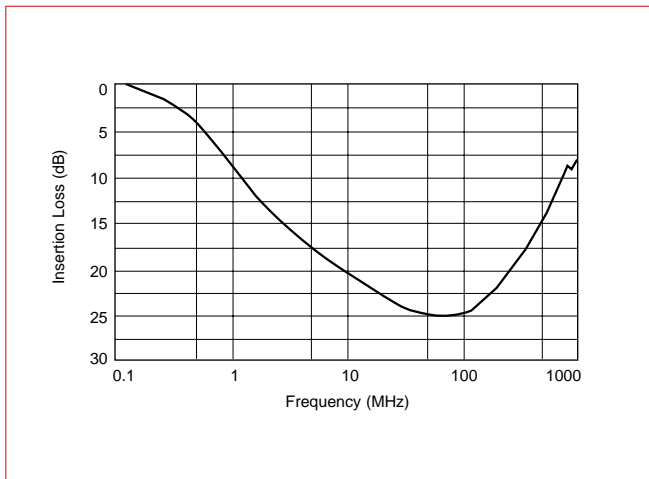

* Available as standard through authorized Murata Electronics Distributors.

APPLICATIONS

Suppression of radiated noise from cable between AC adaptors and sets.

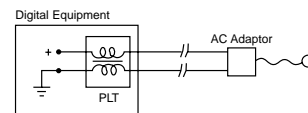

Suppression of radiated noise from DC power supply and interface cables.

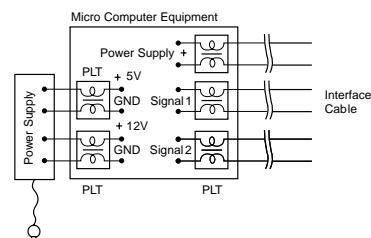

EMI LEADED FILTERS FEED-THRU CAPACITORS SUBMINIATURE

DF220, DF221(H), DF430, TF240(H) & DF331(H) Series

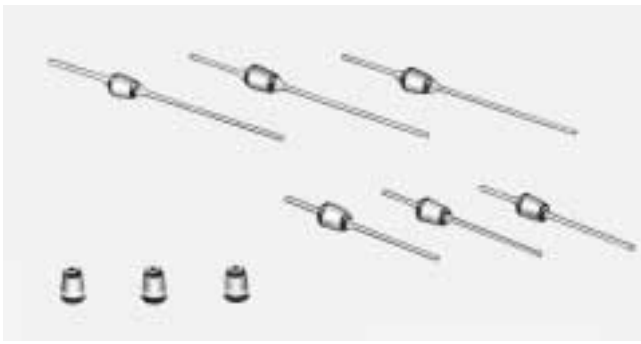

Since the input and output terminals of these feed-thru capacitors are isolated and the inductance on the grounded side is very small, they can be used effectively to very high frequencies.

These devices are suitable for suppression of radiation from TV tuners, car radios, car stereos and transmission devices and provide enhanced protection from external noise sources.

These subminiature feed-thrus, which may be incorporated in 2.54mm pitch connectors, are ideal for miniature electronic equipment.

FEATURES

- The use of barrier layer capacitors has resulted in smaller size and larger capacity than possible with conventional capacitors.
- The nickel alloy electrode is resistant to soldering heat and is free from migration in high humidity environments.
- Compact electronic devices can be achieved by incorporating this capacitor with a 2.54mm pitch packaging density – such as installation in connectors.
- Simple construction allows mass production assembly techniques.

DIMENSIONS: mm

<p>DF430</p>	<p>DF220-00</p>																		
<p>DF221(H)-□□□</p>	<table border="1"> <thead> <tr> <th rowspan="2">Part Number</th> <th colspan="2">Lead</th> </tr> <tr> <th>L₁</th> <th>L₂</th> </tr> </thead> <tbody> <tr> <td>DF221(H)-601</td> <td>10.0 ± 1.0</td> <td>20.0 ± 1.0</td> </tr> <tr> <td>DF221(H)-602</td> <td>20.0 ± 1.0</td> <td>20.0 ± 1.0</td> </tr> </tbody> </table>	Part Number	Lead		L ₁	L ₂	DF221(H)-601	10.0 ± 1.0	20.0 ± 1.0	DF221(H)-602	20.0 ± 1.0	20.0 ± 1.0							
Part Number	Lead																		
	L ₁	L ₂																	
DF221(H)-601	10.0 ± 1.0	20.0 ± 1.0																	
DF221(H)-602	20.0 ± 1.0	20.0 ± 1.0																	
<p>TF240(H)-□□□</p>	<table border="1"> <thead> <tr> <th rowspan="2">Part Number</th> <th colspan="2">Lead</th> </tr> <tr> <th>L₁</th> <th>L₂</th> </tr> </thead> <tbody> <tr> <td>TF240(H)-601</td> <td>10.0 ± 1.0</td> <td>20.0 ± 2.0</td> </tr> <tr> <td>TF240(H)-602</td> <td>5.0 ± 1.0</td> <td>12.0 ± 1.0</td> </tr> <tr> <td>TF240(H)-603</td> <td>5.0 ± 1.0</td> <td>7.0 ± 1.0</td> </tr> </tbody> </table>	Part Number	Lead		L ₁	L ₂	TF240(H)-601	10.0 ± 1.0	20.0 ± 2.0	TF240(H)-602	5.0 ± 1.0	12.0 ± 1.0	TF240(H)-603	5.0 ± 1.0	7.0 ± 1.0				
Part Number	Lead																		
	L ₁	L ₂																	
TF240(H)-601	10.0 ± 1.0	20.0 ± 2.0																	
TF240(H)-602	5.0 ± 1.0	12.0 ± 1.0																	
TF240(H)-603	5.0 ± 1.0	7.0 ± 1.0																	
<p>DF331(H)-□□□</p>	<table border="1"> <thead> <tr> <th rowspan="2">Part Number</th> <th colspan="2">Lead</th> <th rowspan="2">Solder for mounting on the chassis plate</th> </tr> <tr> <th>L₁</th> <th>L₂</th> </tr> </thead> <tbody> <tr> <td>DF331(H)-812</td> <td>6.5 ± 1.0</td> <td>9.5 ± 1.0</td> <td>Provided</td> </tr> <tr> <td>DF331(H)-895</td> <td>6.5 ± 1.0</td> <td>9.5 ± 1.0</td> <td>None</td> </tr> <tr> <td>DF331(H)-805</td> <td>14.0 ± 1.0</td> <td>20.0 ± 1.0</td> <td>Provided</td> </tr> </tbody> </table> <p>Note: Other lead wire lengths are available. Please contact your nearest Sales Office for more detail.</p>	Part Number	Lead		Solder for mounting on the chassis plate	L ₁	L ₂	DF331(H)-812	6.5 ± 1.0	9.5 ± 1.0	Provided	DF331(H)-895	6.5 ± 1.0	9.5 ± 1.0	None	DF331(H)-805	14.0 ± 1.0	20.0 ± 1.0	Provided
Part Number	Lead		Solder for mounting on the chassis plate																
	L ₁	L ₂																	
DF331(H)-812	6.5 ± 1.0	9.5 ± 1.0	Provided																
DF331(H)-895	6.5 ± 1.0	9.5 ± 1.0	None																
DF331(H)-805	14.0 ± 1.0	20.0 ± 1.0	Provided																

SPECIFICATIONS

Part Number*	Cap. Value	Cap. Tol.	WVDC	Insertion Loss at 25°C (Typ.)		
				10MHz	100MHz	1GHz
DF220						
*DF220-00SL020U50	2pF	+0, -100%	50V	—	—	—
*DF220-00SL150M50	15pF	±20%	50V	—	—	6
*DF220-00SL220M50	22pF	±20%	50V	—	—	7
*DF220-00YN430M50	43pF	±20%	50V	—	1	15
*DF220-00B121M50	120pF	±20%	50V	—	3	20
*DF220-00B221M50	220pF	±20%	50V	—	7	25
*DF220-00B471M50	470pF	±20%	50V	—	12	30
*DF220-00E102Z50	1000pF	+80, -20%	50V	3	18	35
*DF220-00SS152GMV50	1500pF	+200, -0%	50V	5	20	40
DF221(H)						
DF221-□□□SL020U50	2pF	+0, -100%	50V	—	—	—
DF221-□□□SL150M50	15pF	±20%	50V	—	—	6
DF221-□□□SL220M50	22pF	±20%	50V	—	—	7
DF221-□□□YN430M50	43pF	±20%	50V	—	1	15
DF221-□□□B121M50	120pF	±20%	50V	—	3	20
DF221-□□□B221M50	220pF	±20%	50V	—	7	25
DF221-□□□B471M50	470pF	±20%	50V	—	12	30
DF221(H)-□□□E(F)102Z50	1000pF	+80, -20%	50V	3	18	35
DF221-□□□SS152GMV50	1500pF	+200, -0%	50V	5	20	40
DF430						
*DF430-0SS332GMV50	3300pF	+200, -0%	50V	10	25	45
TF240(H)						
TF240-□□□SL020D50	2pF	±0.5pF	50V	—	—	—
TF240-□□□SL220M50	22pF	±20%	50V	—	—	7
TF240-□□□B331M50	330pF	±20%	50V	—	10	27
TF240(H)-□□□E(F)102GMV50	1000pF	+200, -0%	50V	3	18	35
TF240-□□□SS332Z50	3300pF	+80, -20%	50V	10	25	45
DF331(H)						
DF331-□□□SL010P50	1pF	+100, -0%	50V	—	—	—
DF331-□□□SL100G50	10pF	±2pF	50V	—	—	—
DF331-□□□SL220M50	22pF	±20%	50V	—	—	7
DF331-□□□SL330M50	33pF	±20%	50V	—	—	12
DF331-□□□YN470M50	47pF	±20%	50V	—	—	15
DF331-□□□YN101M50	100pF	±20%	50V	—	2	19
DF331(H)-□□□E(F)102GMV50	1000pF	+200, -0%	50V	3	18	35
DF331-□□□SS332GMV50	3300pF	+200, -0%	50V	10	25	45

• Operating Temp. Range: Std. = -25°C to +85°C, H = -55°C to +125°C • Insulation Resistance: 1000M Ohms min. *□□□ — See DIMENSIONS
For other capacitance values, consult your local Murata Electronics Sales Office.

*Available as standard through authorized Murata Electronics Distributors.

TF318(H) & TF418 Series

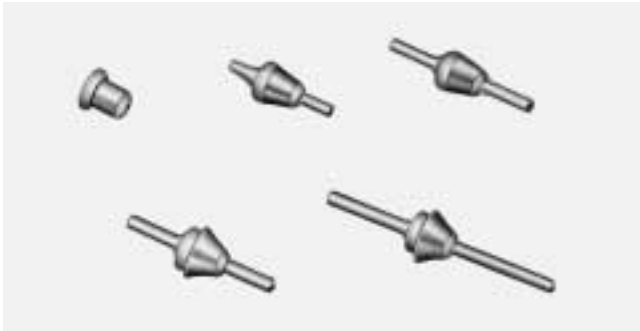

These feed-thru capacitors are designed for high frequency requirements, by-pass applications in VHF and UHF communications equipment and noise filters for car radios, car stereos and two-way radios.

These devices feature simple construction, small size and nickel plated electrodes.

They are migration free and have high thermal strength, mechanical strength and resistance to soldering heat. Ease of mounting makes them ideal for new and conventional feed-thru applications.

DIMENSIONS: mm

TF318(H)0

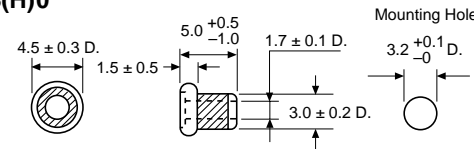

TF318(H)□□□

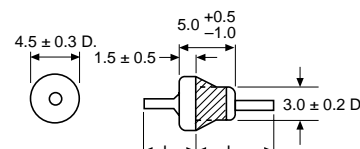

TF418-□□□□

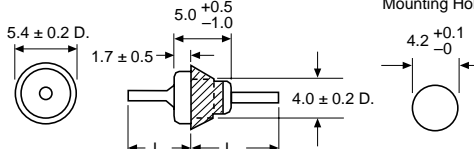

Type	Lead Dia.	L ₁	L ₂
TF318(H)-850	0.8	25.0 ± 2.0	30.0 ± 2.0
TF318(H)-853		14.0 ± 1.0	15.0 ± 1.0
TF318(H)-855		9.5 ± 0.5	11.0 ± 0.5
TF318(H)-053	1.0	11.0 ± 1.0	16.5 ± 1.0
TF318(H)-055		7.0 ± 0.7	6.2 ± 0.7
TF318(H)-450	1.4	4.5 ^{+1.0} _{-0.5}	7.5 ± 1.0
TF318(H)-452		7.0 ± 1.0	9.0 ± 1.0

Type	Lead Dia.	L ₁	L ₂
TF418-452	1.4	7.2 ± 1.0	8.8 ± 1.0
TF418-454		10.2 ± 1.0	13.8 ± 1.0

SPECIFICATIONS

Part Number	Cap.	Cap. Tol.	Temp. Char.	Rated Voltage
TF318-□SL100G50	10pF	±20%	SL	50VDC
TF318-□SL220M50	22pF	±20%	SL	50VDC
TF318-□SL330M50	33pF	±20%	SL	50VDC
TF318-□SL470M50	47pF	±20%	SL	50VDC
TF318-□YN101M50	100pF	±20%	YN	50VDC
TF318-□B271M50	270pF	±20%	B	50VDC
TF318(H)-□B(F)471M50	470pF	±20%	B	50VDC
TF318-□E102GMV50	1000pF	⁺²⁰⁰ / ₋₀ %	E	50VDC
TF318-□E152P50	1500pF	⁺¹⁰⁰ / ₋₀ %	E	50VDC

Part Number	Cap.	Cap. Tol.	Temp. Char.	Rated Voltage
TF418-□E102GMV300	1000pF	⁺²⁰⁰ / ₋₀ %	E	300VDC
TF418-□E152P300	1500pF	⁺¹⁰⁰ / ₋₀ %	E	300VDC

□ Denotes configurations shown above.

Examples:

TF318-450B271M50

TF418-452E102GMV300

Operating temperature:

Std: -25°C to +85°C

H Series: -55°C to +125°C

PART NUMBERING SYSTEM

TF318 450 E 102 GMV 50V

Type and Dimensions
Temperature Characteristic

Code	Max. Cap. Change	Temp. Range
B	±10%	-25°C to +85°C
E	⁺²⁰ / ₋₅₅ %	-25°C to +85°C
Code	Temp. Coefficient	
SL	+350 to -1000ppm/°C	
YN	-500 to -5800ppm/°C	

Cap. Tolerance

Nominal Capacitance

Rated Voltage
TF318-50V-ONLY
TF418-300V-ONLY



The EA10/EA20 series is an EMC absorber suitable for filtering from 100MHz to 20GHz.

FEATURES

- Excellent elasticity and durability with silicon rubber
- Suitable for prevention of abnormal oscillation in high frequency module, suppression of spurious spectra and interference between circuits

PART NUMBERING SYSTEM

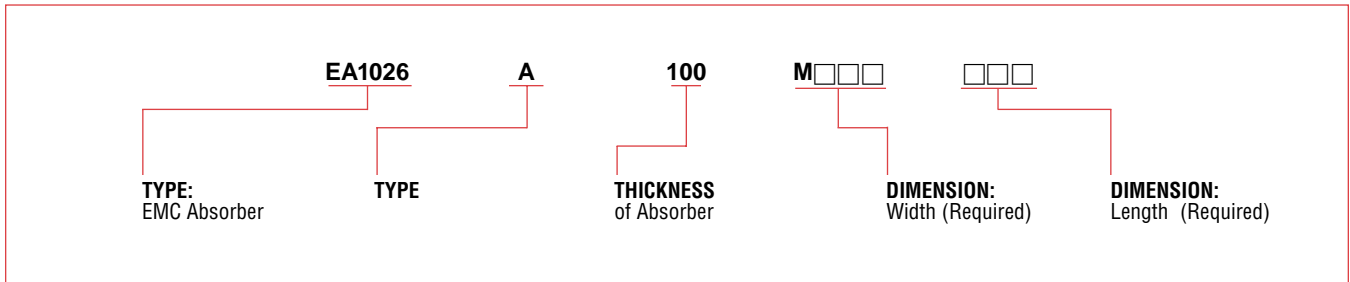

SPECIFICATIONS

Part Number	Applicable Frequency (GHz)	Thickness (mm)
EA1026A100	20.0	1.0
EA1026A160	11.5	1.6
EA1026A180	10.0	1.8
EA1046A180	5.8	1.8
EA1075A270	2.5	2.7
EA2070A020	0.1 ~ 3.0	0.2
EA2070A050		0.5
EA2070A100		1.0

EA10 SERIES

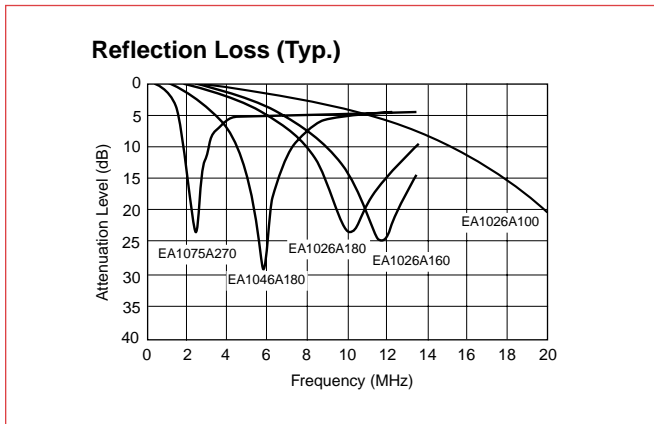

EA20 SERIES

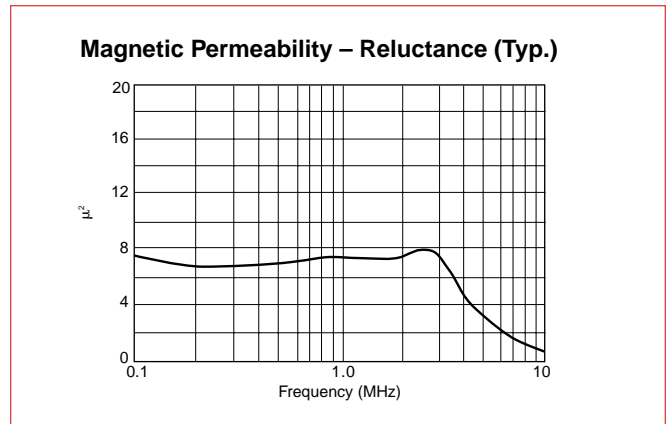



The unique FSOC ferrite cores provide high frequency EMI noise suppression for split and flat cables and find wide application in computers and peripherals to several hundreds of MHz. They are exceptionally easy to install and extremely effective.

FEATURES

- Extremely effective EMI noise prevention
- Wide application in data processing equipment
- Simple installation
- No soldered connections

PART NUMBERING SYSTEM

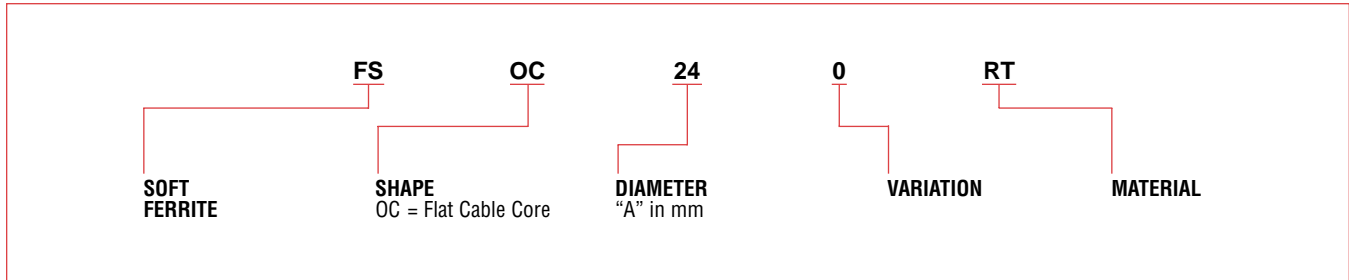

DIMENSIONS: mm

SPECIFICATIONS

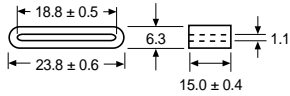
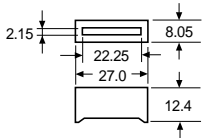
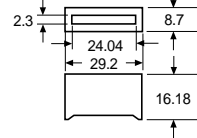
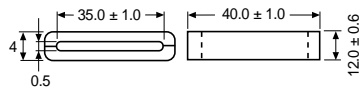
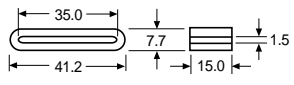
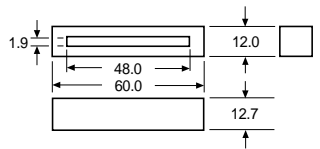
	Part Number	Impedance (Ohms) (100MHz)
	FSOC240RT	77
	FSOC270RN	60
	FSOC290PB	62
	FSOC400RT	80
	FSOC410RN	70
	FSOC600RN	72

FLAT CABLE CORES

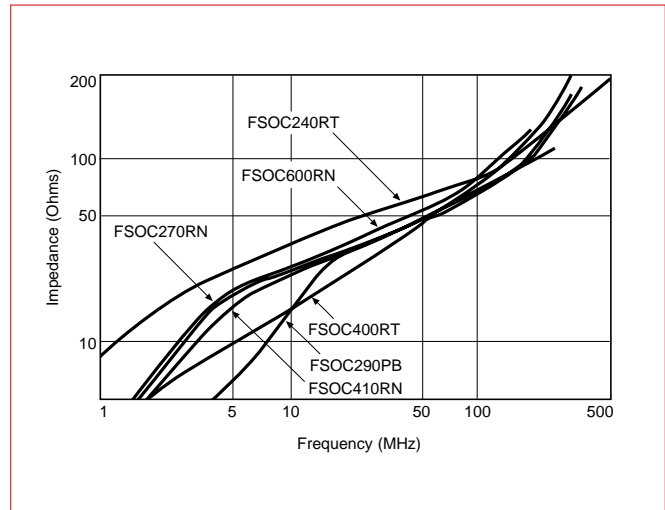



Стандарт Электрон Связь

Мы молодая и активно развивающаяся компания в области поставок электронных компонентов. Мы поставляем электронные компоненты отечественного и импортного производства напрямую от производителей и с крупнейших складов мира.

Благодаря сотрудничеству с мировыми поставщиками мы осуществляем комплексные и плановые поставки широчайшего спектра электронных компонентов.

Собственная эффективная логистика и склад в обеспечивает надежную поставку продукции в точно указанные сроки по всей России.

Мы осуществляем техническую поддержку нашим клиентам и предпродажную проверку качества продукции. На все поставляемые продукты мы предоставляем гарантию .

Осуществляем поставки продукции под контролем ВП МО РФ на предприятия военно-промышленного комплекса России , а также работаем в рамках 275 ФЗ с открытием отдельных счетов в уполномоченном банке. Система менеджмента качества компании соответствует требованиям ГОСТ ISO 9001.

Минимальные сроки поставки, гибкие цены, неограниченный ассортимент и индивидуальный подход к клиентам являются основой для выстраивания долгосрочного и эффективного сотрудничества с предприятиями радиоэлектронной промышленности, предприятиями ВПК и научно-исследовательскими институтами России.

С нами вы становитесь еще успешнее!

Наши контакты:

Телефон: +7 812 627 14 35

Электронная почта: sales@st-electron.ru

Адрес: 198099, Санкт-Петербург,
Промышленная ул, дом № 19, литера Н,
помещение 100-Н Офис 331