



# Low-Power, 1%-Accurate Battery Monitors in $\mu$ DFN and SC70 Packages

## General Description

The MAX6775–MAX6781 low-power, 1%-accurate battery monitors are available in the ultra-small  $\mu$ DFN package (1.0mm x 1.5mm) and SC70 packages. These low-power devices are ideal for monitoring single lithium-ion (Li+) cells, or multicell alkaline/NiCd/NiMH power sources. These devices offer single (MAX6775/MAX6776/MAX6777/MAX6778) or dual (MAX6779/MAX6780/MAX6781) low-battery outputs and feature fixed or resistor-adjustable hysteresis. Hysteresis eliminates the output chatter sometimes associated with battery voltage monitors, usually due to input-voltage noise or battery terminal voltage recovery after load removal.

These devices are available in several versions: with single- or dual-voltage monitors, and with fixed or adjustable hysteresis. The MAX6775/MAX6776 offer a single battery monitor and factory-set hysteresis of 0.5%, 5%, or 10%. The MAX6779/MAX6780/MAX6781 have two battery monitors in a single package and factory-set hysteresis of 0.5%, 5%, or 10%. The MAX6777/MAX6778 offer a single battery monitor with external inputs for the rising and falling thresholds, allowing external hysteresis control.

For convenient interface with system power circuitry or microprocessors, both open-drain and push-pull outputs are available. The single-channel devices are available with open-drain or push-pull outputs. The dual-channel devices are available with both outputs open-drain, both outputs push-pull, or one of each (see the *Selector Guide*). This family of devices is offered in small 5-pin SC70 and ultra-small 6-pin  $\mu$ DFN packages, and is fully specified over the -40°C to +85°C extended temperature range.

## Applications

Battery-Powered Systems (Single-Cell Li+ or Multicell NiMH, NiCd, Alkaline)  
 Cell Phones/Cordless Phones  
 Pagers  
 Portable Medical Devices  
 PDAs  
 Electronic Toys  
 MP3 Players

Pin Configurations appear at end of data sheet.



For pricing, delivery, and ordering information, please contact Maxim Direct at 1-888-629-4642, or visit Maxim's website at [www.maxim-ic.com](http://www.maxim-ic.com).

## Features

- ◆ 1.0%-Accurate Threshold Specified Over Temperature
- ◆ Single/Dual, Low-Battery Output Options
- ◆ Low 3 $\mu$ A Battery Current
- ◆ Open-Drain or Push-Pull Low-Battery Outputs
- ◆ Fixed or Adjustable Hysteresis
- ◆ Low-Input Leakage Current Allows Use of Large Resistors
- ◆ Guaranteed Valid Low-Battery-Output Logic State Down to  $V_{BATT} = 1V$
- ◆ Immune to Short Battery Transients
- ◆ Fully Specified from -40°C to +85°C
- ◆ Small 5-Pin SC70 or Ultra-Small 6-Pin  $\mu$ DFN (1mm x 1.5mm) Package

## Ordering Information

PART	TEMP RANGE	PIN-PACKAGE
MAX6775XK_+T	-40°C to +85°C	5 SC70
MAX6775LT_+T	-40°C to +85°C	6 $\mu$ DFN
MAX6776XK_+T	-40°C to +85°C	5 SC70
MAX6776LT_+T	-40°C to +85°C	6 $\mu$ DFN
MAX6777XK_+T	-40°C to +85°C	5 SC70
MAX6777LT_+T	-40°C to +85°C	6 $\mu$ DFN

Ordering Information continued at end of data sheet.

+Denotes a lead(Pb)-free/RoHS-compliant package.

T = Tape and reel.

MAX6775/MAX6776/MAX6779/MAX6780/MAX6781 are available with factory-trimmed hysteresis. Specify trim by replacing “\_” with “A” for 0.5%, “B” for 5%, or “C” for 10% hysteresis.

## Typical Operating Circuit

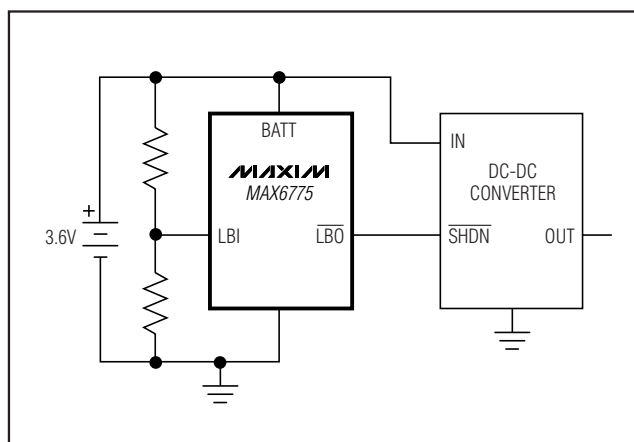

# Low-Power, 1%-Accurate Battery Monitors in $\mu$ DFN and SC70 Packages

## ABSOLUTE MAXIMUM RATINGS

BATT to GND.....	-0.3V to +6V	Continuous Power Dissipation ( $T_A = +70^\circ\text{C}$ )
LBI, LBL, LBH, LBI1, LBI2 to GND .....	-0.3V to minimum of (( $V_{BATT} + 0.3\text{V}$ ) and +6V)	5-Pin SC70 (derate 3.1mW/ $^\circ\text{C}$ above +70 $^\circ\text{C}$ ) .....
$\overline{\text{LBO}}$ , $\overline{\text{LBO1}}$ , $\overline{\text{LBO2}}$ to GND (open-drain) .....	-0.3V to +6V	6-Pin $\mu$ DFN (derate 2.1mW/ $^\circ\text{C}$ above +70 $^\circ\text{C}$ ) .....
LBO, LBO1, LBO2 to GND (push-pull).....	-0.3V to minimum of (( $V_{BATT} + 0.3\text{V}$ ) and +6V)	Junction Temperature .....
Input Current (all pins) .....	20mA	Storage Temperature Range .....
Output Current (all pins) .....	20mA	Lead Temperature (soldering, 10s) .....

Stresses beyond those listed under "Absolute Maximum Ratings" may cause permanent damage to the device. These are stress ratings only, and functional operation of the device at these or any other conditions beyond those indicated in the operational sections of the specifications is not implied. Exposure to absolute maximum rating conditions for extended periods may affect device reliability.

## ELECTRICAL CHARACTERISTICS

( $V_{BATT} = 1.6\text{V}$  to  $5.5\text{V}$ ,  $T_A = -40^\circ\text{C}$  to  $+85^\circ\text{C}$ , unless otherwise specified. Typical values are at  $T_A = +25^\circ\text{C}$ .) (Note 1)

PARAMETER	SYMBOL	CONDITIONS	MIN	TYP	MAX	UNITS
Operating Voltage Range (Note 2)	$V_{BATT}$	$T_A = 0^\circ\text{C}$ to $+70^\circ\text{C}$	1.0		5.5	V
		$T_A = -40^\circ\text{C}$ to $+85^\circ\text{C}$	1.2		5.5	
Supply Current	$I_Q$	$V_{BATT} = 3.7\text{V}$ , no load		4	7	$\mu\text{A}$
		$V_{BATT} = 1.8\text{V}$ , no load		3.2	6	
<b>FIXED HYSTERESIS</b> (MAX6775/MAX6776/MAX6779/MAX6780/MAX6781)						
LBI, LBI_ Falling Threshold (Note 3)	$V_{LBIF}$	0.5% hysteresis version	1.2037	1.2159	1.2280	V
		5% hysteresis version	1.1493	1.1609	1.1725	
		10% hysteresis version	1.0888	1.0998	1.1108	
LBI Rising Threshold	$V_{LBIR}$		1.2098	1.222	1.2342	V
LBI Input Leakage Current		$0.2\text{V} \leq V_{LBI} \leq V_{BATT} - 0.2\text{V}$	-5		+5	nA
<b>ADJUSTABLE HYSTERESIS</b> (MAX6777/MAX6778)						
LBL, LBH Threshold		$V_{BATT} = 1.8\text{V}$ to $5.5\text{V}$	1.2098	1.222	1.2342	V
LBL, LBH Input Leakage Current		$V_{BATT} - 0.2\text{V} \geq V_{LBL/LBH} \geq 0.2\text{V}$	-5		+5	nA

# Low-Power, 1%-Accurate Battery Monitors in $\mu$ DFN and SC70 Packages

MAX6775-MAX6781

## ELECTRICAL CHARACTERISTICS (continued)

( $V_{BATT} = 1.6V$  to  $5.5V$ ,  $T_A = -40^\circ C$  to  $+85^\circ C$ , unless otherwise specified. Typical values are at  $T_A = +25^\circ C$ .) (Note 1)

PARAMETER	SYMBOL	CONDITIONS	MIN	TYP	MAX	UNITS
<b>LOW-BATTERY OUTPUTS (LBO, LBO1, LBO2)</b>						
Propagation Delay	$t_{PD}$	$V_{LBI\_+} + 100mV$ to $V_{LBI\_ -} - 100mV$		9		$\mu s$
Startup Time		$V_{BATT}$ rising above 1.6V			3	ms
Output Low (Push-Pull or Open-Drain)	$V_{OL}$	$V_{BATT} \geq 1.2V$ , $I_{SINK} = 100\mu A$			0.3	V
		$V_{BATT} \geq 2.7V$ , $I_{SINK} = 1.2mA$			0.3	
		$V_{BATT} \geq 4.5V$ , $I_{SINK} = 3.2mA$			0.3	
Output High (Push-Pull )	$V_{OH}$	$V_{BATT} \geq 1.6V$ , $I_{SOURCE} = 100\mu A$		$0.8 \times V_{BATT}$		V
		$V_{BATT} \geq 2.7V$ , $I_{SOURCE} = 500\mu A$		$0.8 \times V_{BATT}$		
		$V_{BATT} \geq 4.5V$ , $I_{SOURCE} = 800\mu A$		$0.8 \times V_{BATT}$		
Output Leakage Current (Open-Drain)		Output not asserted, $V_{LBO\_} = 5.5V$	-100		+100	nA

**Note 1:** Devices are tested at  $T_A = +25^\circ C$  and guaranteed by design for  $T_A = T_{MIN}$  to  $T_{MAX}$ , as specified.

**Note 2:** Operating range ensures low-battery output is in the correct state. Minimum battery voltage for electrical specification is 1.6V.

**Note 3:** The rising threshold is guaranteed to be higher than the falling threshold.

## Typical Operating Characteristics

( $T_A = +25^\circ C$ , unless otherwise noted.)

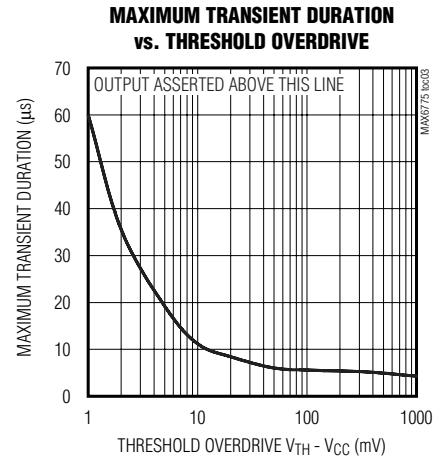
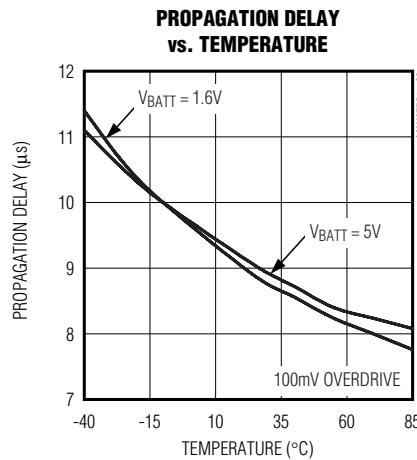
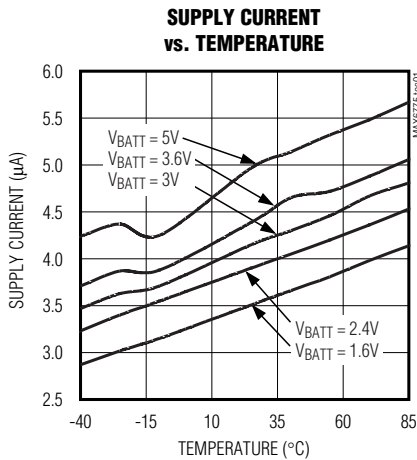

# Low-Power, 1%-Accurate Battery Monitors in $\mu$ DFN and SC70 Packages

## Typical Operating Characteristics (continued)

( $T_A = +25^\circ\text{C}$ , unless otherwise noted.)

**NORMALIZED THRESHOLD VOLTAGES vs. TEMPERATURE, MAX67\_A**



**NORMALIZED THRESHOLD VOLTAGES vs. TEMPERATURE, MAX67\_B**



**NORMALIZED THRESHOLD VOLTAGES vs. TEMPERATURE, MAX67\_C**

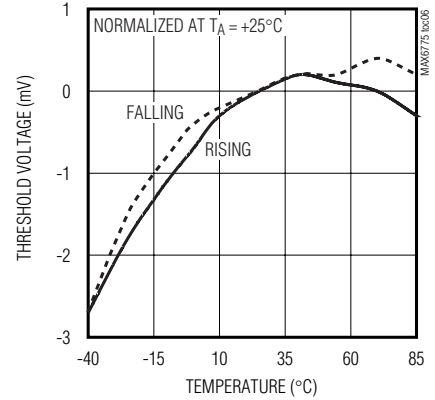

**LBO OUTPUT VOLTAGE vs. SINK CURRENT**



**LBO OUTPUT VOLTAGE vs. SOURCE CURRENT**

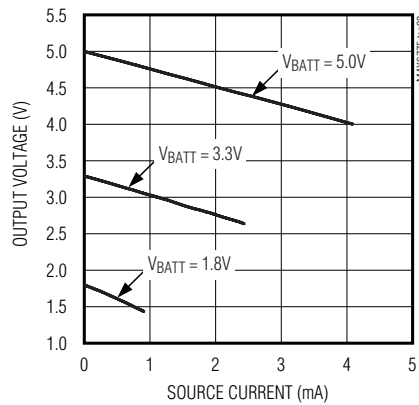

# Low-Power, 1%-Accurate Battery Monitors in $\mu$ DFN and SC70 Packages

## Pin Description

MAX6775/ MAX6776		MAX6777/ MAX6778		MAX6779/ MAX6780/ MAX6781	NAME	FUNCTION
$\mu$ DFN	SC70	$\mu$ DFN	SC70	$\mu$ DFN		
1	1	—	—	—	GND2	Reserved. Must be connected to GND. Do not use as the only GND connection.
2	2	2	2	2	GND	Ground
3	3	—	—	—	LBI	Low-Battery Input. Connect to the resistive divider to set the trip level.
4	4	4	4	—	$\overline{\text{LBO}}$	Low-Battery Output, Active-Low. When $V_{\text{LBI}}/V_{\text{LBL}}$ falls below the falling threshold, $\overline{\text{LBO}}$ asserts. $\overline{\text{LBO}}$ deasserts when $V_{\text{LBI}}/V_{\text{LBH}}$ exceeds the rising threshold voltage.
5	—	5	—	—	N.C.	No Connection. Not internally connected.
6	5	6	5	6	BATT	Battery Input. Power supply to the device.
—	—	1	1	—	LBH	Rising-Trip-Level Input. Connect to a resistive divider to set the rising trip level.
—	—	3	3	—	LBL	Falling-Trip-Level Input. Connect to a resistive divider to set the falling trip level.
—	—	—	—	1	LBI2	Low-Battery Input 2. Connect to a resistive divider to set the trip level.
—	—	—	—	3	LBI1	Low-Battery Input 1. Connect to a resistive divider to set the trip level.
—	—	—	—	4	$\overline{\text{LBO1}}$	Low-Battery Output 1, Active-Low. When $V_{\text{LBI1}}$ falls below the falling threshold voltage, $\overline{\text{LBO1}}$ asserts. $\overline{\text{LBO1}}$ deasserts when $V_{\text{LBI1}}$ exceeds the rising threshold voltage. $\overline{\text{LBO1}}$ is push-pull on the MAX6779/MAX6781 and open-drain for the MAX6780.
—	—	—	—	5	$\overline{\text{LBO2}}$	Low-Battery Output 2, Active-Low. When $V_{\text{LBI2}}$ falls below the falling threshold voltage, $\overline{\text{LBO2}}$ asserts. $\overline{\text{LBO2}}$ deasserts when $V_{\text{LBI2}}$ exceeds the rising threshold voltage. $\overline{\text{LBO2}}$ is open-drain for the MAX6780/MAX6781 and push-pull for the MAX6779.

MAX6775-MAX6781

# Low-Power, 1%-Accurate Battery Monitors in $\mu$ DFN and SC70 Packages

## Detailed Description

These battery monitors have an active-low output that asserts when the input falls below a set voltage. They also offer hysteresis for noise immunity, and to remove the possibility of output chatter due to battery terminal voltage recovery after load removal. They are available with one or two monitors per package, with push-pull or open-drain outputs, and with internally set or externally adjustable hysteresis (dual-channel devices offer only internally fixed hysteresis). Figures 1, 2, and 3 show block diagrams and typical connections. See the *Selector Guide* for details.

### Low-Battery Output

All devices are offered with either push-pull or open-drain outputs (see the *Selector Guide*). The MAX6781 has one push-pull output and one open-drain output, configured as in Table 1.

On all devices with open-drain outputs an external pullup resistor is required. The open-drain pullup resistor can connect to an external voltage up to +6V, regardless of the voltage at BATT.

**Table 1. MAX6781 Outputs**

DEVICE	LBO1	LBO2
MAX6781	Push-Pull	Open-Drain



Figure 2. Dual-Channel Fixed-Hysteresis Block Diagram



Figure 1. Single-Channel Fixed-Hysteresis Block Diagram



Figure 3. Single-Channel Adjustable-Hysteresis Block Diagram

# Low-Power, 1%-Accurate Battery Monitors in $\mu$ DFN and SC70 Packages

MAX6775-MAX6781

The MAX6779, MAX6780, and MAX6781 monitor two battery levels or two independent voltages. A common application for this type of dual-battery monitor is to use one output as an early warning signal and the other as a dead-battery indicator.

## Hysteresis

Input hysteresis defines two thresholds, separated by a small voltage (the hysteresis voltage), configured so the output asserts when the input falls below the falling threshold, and deasserts only when the input rises above the rising threshold. Figure 4 shows this graphically. Hysteresis removes, or greatly reduces, the possibility of the output changing state in response to noise or battery terminal voltage recovery after load removal.

## Fixed Hysteresis

The MAX6775/MAX6776/MAX6779/MAX6780/MAX6781 have factory-set hysteresis for ease of use, and reduce component count. For these devices, the absolute hysteresis voltage is a percentage of the internally generated reference. The amount depends on the device option. "A" devices have 0.5% hysteresis, "B" devices have 5% hysteresis, and "C" devices have 10% hysteresis. Table 2 presents the threshold voltages for devices with internally fixed hysteresis.

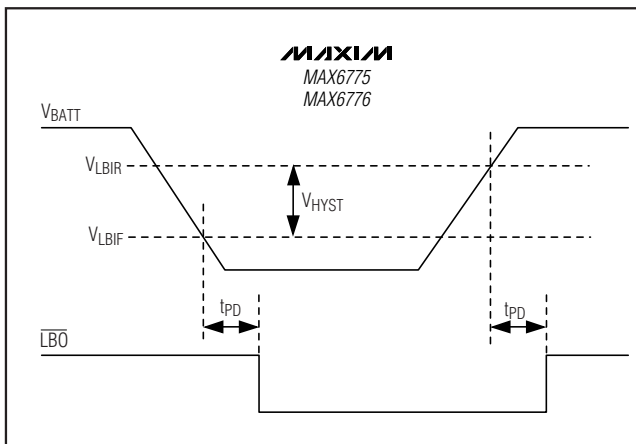

Figure 4. Hysteresis

Table 2. Typical Falling and Rising Thresholds for MAX6775/MAX6776/MAX6779/MAX6780/MAX6781

DEVICE OPTION	PERCENT HYSTERESIS (%)	FALLING THRESHOLD ( $V_{LBIF}$ ) (V)	RISING THRESHOLD ( $V_{LBIR}$ ) (V)	HYSTERESIS VOLTAGE ( $V_{HYST}$ ) (mV)
A	0.5	1.2159	1.222	6.11
B	5	1.1609	1.222	61.1
C	10	1.0998	1.222	122

## Adjustable Hysteresis

The MAX6777/MAX6778 offer external hysteresis control through the resistive divider that monitors battery voltage. Figure 3 shows the connections for external hysteresis. See the *Calculating an External Hysteresis Resistive Divider* section for more information.

## Applications Information

### Resistor-Value Selection

Choosing the proper external resistors is a balance between accuracy and power use. The input to the voltage monitor, while high impedance, draws a small current, and that current travels through the resistive divider, introducing error. If extremely high resistor values are used, this current introduces significant error. With extremely low resistor values, the error becomes negligible, but the resistive divider draws more power from the battery than necessary and shortens battery life. Figure 1 calculates the optimum value for  $R_H$  using:

$$R_H = \frac{e_A \times V_{BATT}}{I_L}$$

where  $e_A$  is the maximum acceptable absolute resistive divider error (use 0.01 for 1%),  $V_{BATT}$  is the battery voltage at which LBO should activate, and  $I_L$  is the worst-case LBI leakage current. For example, with 0.5% accuracy, a 2.8V battery minimum, and 5nA leakage,  $R_H = 2.80M\Omega$ .

Calculate  $R_L$  using:

$$R_L = -\frac{V_{LBIF} \times R_H}{V_{LBIF} - V_{BATT}}$$

where  $V_{LBIF}$  is the falling threshold voltage from Table 2. Continuing the above example, select  $V_{LBIF} = 1.0998V$  (10% hysteresis device) and  $R_L = 1.81M\Omega$ .

# Low-Power, 1%-Accurate Battery Monitors in $\mu$ DFN and SC70 Packages

## Calculating an External Hysteresis Resistive Divider

Setting the hysteresis externally requires three external resistors, as shown in Figure 3. Select  $R_H$  using the following formula:

$$R_H \leq \frac{e_A \times V_{BATT\_RISING}}{I_L}$$

where  $e_A$  is the allowable error due to input leakage current (typically 0.005 or less),  $V_{BATT\_RISING}$  is the desired rising threshold, and  $I_L$  is the worst-case leakage current (5nA). Then calculate  $R_{LO}$  (which is the sum of  $R_L$  and  $R_{HYST}$ ):

$$R_{LO} = \frac{V_{LBI} \times R_H}{V_{BATT\_FALLING} - V_{LBI}}$$

where  $V_{LBI}$  is 1.222V and  $V_{BATT\_FALLING}$  is the desired falling threshold. Calculate  $R_L$  using:

$$R_L = \frac{V_{LBI} \times (R_H + R_{LO})}{V_{BATT\_RISING}}$$

and finally, calculate  $R_{HYST}$ :

$$R_{HYST} = R_{LO} - R_L$$

## Monitoring a Battery Voltage Higher Than the Allowable $V_{BATT}$

For monitoring higher voltages, supply power to BATT that is within the specified supply range, and power the input resistive divider from the high voltage to be monitored. Do not exceed the *Absolute Maximum Ratings*.

## Adding External Capacitance to Reduce Noise and Transients

If monitoring voltages in a noisy environment, add a bypass capacitor of 0.1 $\mu$ F from BATT to GND as close as possible to the device. For systems with large transients, additional capacitance may be required. A small capacitor (<1nF) from LBI\_ to GND may provide additional noise immunity.

## Selector Guide

PART	LBO OUTPUT	OUTPUT TYPE	HYSTERESIS	PIN-PACKAGE
MAX6775XK_+T	Single	Push-Pull	Fixed	5 SC70
MAX6775LT_+T	Single	Push-Pull	Fixed	6 $\mu$ DFN
MAX6776XK_+T	Single	Open-Drain	Fixed	5 SC70
MAX6776LT_+T	Single	Open-Drain	Fixed	6 $\mu$ DFN
MAX6777XK_+T	Single	Push-Pull	Adjustable	5 SC70
MAX6777LT_+T	Single	Push-Pull	Adjustable	6 $\mu$ DFN
MAX6778XK_+T	Single	Open-Drain	Adjustable	5 SC70
MAX6778LT_+T	Single	Open-Drain	Adjustable	6 $\mu$ DFN
MAX6779LT_+T	Dual	Push-Pull	Fixed	6 $\mu$ DFN
MAX6780LT_+T	Dual	Open-Drain	Fixed	6 $\mu$ DFN
MAX6781LT_+T	Dual	Mixed	Fixed	6 $\mu$ DFN



# Low-Power, 1%-Accurate Battery Monitors in $\mu$ DFN and SC70 Packages

## Top Marks

PART	TOP MARK
<b>MAX6775</b> XKA+T	ASA
MAX6775XKB+T	ASB
MAX6775XKC+T	ASC
MAX6775LTA+T	BU
MAX6775LTB+T	BW
MAX6775LTC+T	BX
<b>MAX6776</b> XKA+T	ASJ
MAX6776XKB+T	ASK
MAX6776XKC+T	ASL
MAX6776LTA+T	BY
MAX6776LTB+T	BZ
MAX6776LTC+T	CA

PART	TOP MARK
<b>MAX6777</b> XK+T	ASD
MAX6777LT+T	CB
<b>MAX6778</b> XK+T	ASI
MAX6778LT+T	CC
<b>MAX6779</b> LTA+T	BL
MAX6779LTB+T	BM
MAX6779LTC+T	BN
<b>MAX6780</b> LTA+T	BO
MAX6780LTB+T	BP
MAX6780LTC+T	BQ
<b>MAX6781</b> LTA+T	BR
MAX6781LTB+T	BS
MAX6781LTC+T	BT

**MAX6775-MAX6781**

## Ordering Information (continued)

PART	TEMP RANGE	PIN-PACKAGE
<b>MAX6778</b> XK+T	-40°C to +85°C	5 SC70
MAX6778LT+T	-40°C to +85°C	6 $\mu$ DFN
<b>MAX6779</b> LT_ <sub>-</sub> +T	-40°C to +85°C	6 $\mu$ DFN
<b>MAX6780</b> LT_ <sub>-</sub> +T	-40°C to +85°C	6 $\mu$ DFN
<b>MAX6781</b> LT_ <sub>-</sub> +T	-40°C to +85°C	6 $\mu$ DFN

+Denotes a lead(Pb)-free/RoHS-compliant package.

T = Tape and reel.

MAX6775/MAX6776/MAX6779/MAX6780/MAX6781 are available with factory-trimmed hysteresis. Specify trim by replacing “\_” with “A” for 0.5%, “B” for 5%, or “C” for 10% hysteresis.

## Chip Information

PROCESS: BICMOS

# Low-Power, 1%-Accurate Battery Monitors in $\mu$ DFN and SC70 Packages

## Pin Configurations



## Package Information

For the latest package outline information and land patterns, go to [www.maxim-ic.com/packages](http://www.maxim-ic.com/packages).

PACKAGE TYPE	PACKAGE CODE	DOCUMENT NO.
5 SC70	X5-1	<a href="#">21-0076</a>
6 $\mu$ DFN	L611-1	<a href="#">21-0147</a>

# Low-Power, 1%-Accurate Battery Monitors in $\mu$ DFN and SC70 Packages

## Revision History

REVISION NUMBER	REVISION DATE	DESCRIPTION	PAGES CHANGED
4	5/09	Updated <i>Calculating an External Hysteresis Resistive Divider</i> section	8

MAX6775-MAX6781

Maxim cannot assume responsibility for use of any circuitry other than circuitry entirely embodied in a Maxim product. No circuit patent licenses are implied. Maxim reserves the right to change the circuitry and specifications without notice at any time.

Maxim Integrated Products, 120 San Gabriel Drive, Sunnyvale, CA 94086 408-737-7600 \_\_\_\_\_ 11



## Стандарт Электрон Связь

Мы молодая и активно развивающаяся компания в области поставок электронных компонентов. Мы поставляем электронные компоненты отечественного и импортного производства напрямую от производителей и с крупнейших складов мира.

Благодаря сотрудничеству с мировыми поставщиками мы осуществляем комплексные и плановые поставки широчайшего спектра электронных компонентов.

Собственная эффективная логистика и склад в обеспечивает надежную поставку продукции в точно указанные сроки по всей России.

Мы осуществляем техническую поддержку нашим клиентам и предпродажную проверку качества продукции. На все поставляемые продукты мы предоставляем гарантию .

Осуществляем поставки продукции под контролем ВП МО РФ на предприятия военно-промышленного комплекса России , а также работаем в рамках 275 ФЗ с открытием отдельных счетов в уполномоченном банке. Система менеджмента качества компании соответствует требованиям ГОСТ ISO 9001.

Минимальные сроки поставки, гибкие цены, неограниченный ассортимент и индивидуальный подход к клиентам являются основой для выстраивания долгосрочного и эффективного сотрудничества с предприятиями радиоэлектронной промышленности, предприятиями ВПК и научно-исследовательскими институтами России.

С нами вы становитесь еще успешнее!

### Наши контакты:

**Телефон:** +7 812 627 14 35

**Электронная почта:** [sales@st-electron.ru](mailto:sales@st-electron.ru)

**Адрес:** 198099, Санкт-Петербург,  
Промышленная ул, дом № 19, литера Н,  
помещение 100-Н Офис 331