

## DESCRIPTION

The MP2012 is a fully integrated, internally compensated 1.2MHz fixed frequency PWM step-down converter. It is ideal for powering portable equipment that runs from a single cell Lithium-Ion (Li+) Battery, with an input range from 2.7V to 6V. The MP2012 can provide up to 1.5A of load current with output voltage as low as 0.8V. It can also operate at 100% duty cycle for low dropout applications. With peak current mode control and internal compensation, the MP2012 is stable with ceramic capacitors and small inductors. Fault condition protection includes cycle-by-cycle current limiting and thermal shutdown.

MP2012 is available in a small QFN6 (3x3mm) package.

## FEATURES

- 2.7-6V Input Operation Range
- Output Adjustable from 0.8V to VIN
- 1µA Max Shutdown Current.
- Up to 95% Efficiency
- 100% Duty Cycle for Low Dropout Applications
- 1.2MHz Fixed Switching Frequency
- Stable with Low ESR Output Ceramic Capacitors
- Thermal Shutdown
- Cycle-by-Cycle Over Current Protection
- Short Circuit Protection
- Available in QFN6 (3x3mm)

## APPLICATIONS

- DVD+/-RW Drives
- Smart Phones
- PDAs
- Digital Cameras
- Portable Instruments

For MPS green status, please visit MPS website under Quality Assurance. "MPS" and "The Future of Analog IC Technology" are Trademarks of Monolithic Power Systems, Inc.

## TYPICAL APPLICATION

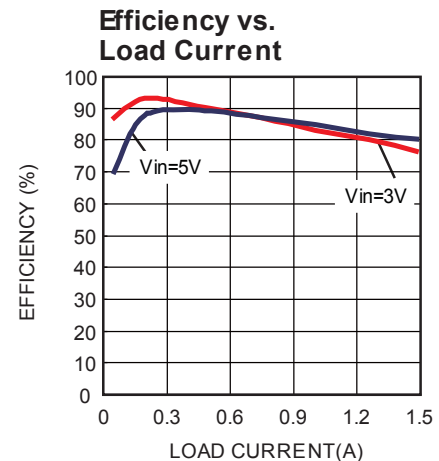
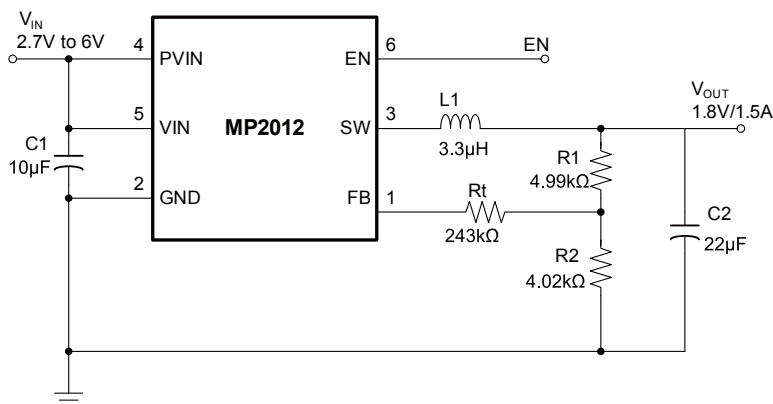

### ORDERING INFORMATION

Part Number*	Package	Top Marking	Free Air Temperature (T <sub>A</sub> )
MP2012DQ	QFN6(3x3mm)	9E	-40°C to +85°C

\* For Tape & Reel, add suffix -Z (e.g. MP2012DQ-Z).  
 For RoHS compliant packaging, add suffix -LF (e.g. MP2012DQ-LF-Z)

### PACKAGE REFERENCE

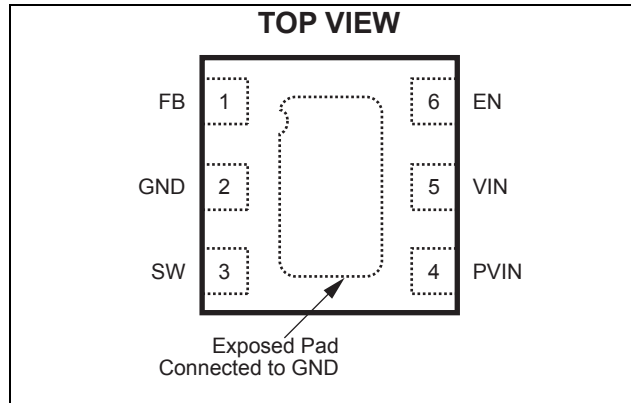

#### ABSOLUTE MAXIMUM RATINGS <sup>(1)</sup>

PVIN, VIN to GND.....	-0.3V to + 6.5V
SW to GND .....	-0.3V to V <sub>IN</sub> + 0.3V
EN, FB to GND .....	-0.3V to +6.5V
Operating Temperature.....	-40°C to +85°C
Continuous Power Dissipation (T <sub>A</sub> = +25°C) <sup>(2)</sup>	.....2.5W
Junction Temperature .....	150°C
Lead Temperature .....	260°C
Storage Temperature .....	-65°C to +150°C

#### Recommended Operating Conditions <sup>(3)</sup>

Supply Voltage V <sub>IN</sub> .....	2.7V to 6V
Operating Junct. Temp (T <sub>J</sub> ).....	-40°C to +125°C

#### Thermal Resistance <sup>(4)</sup>

	$\theta_{JA}$	$\theta_{JC}$
QFN6 (3x3mm) .....	50	12 ... °C/W

#### Notes:

- Exceeding these ratings may damage the device.
- The maximum allowable power dissipation is a function of the maximum junction temperature T<sub>J</sub> (MAX), the junction-to-ambient thermal resistance  $\theta_{JA}$ , and the ambient temperature T<sub>A</sub>. The maximum allowable continuous power dissipation at any ambient temperature is calculated by P<sub>D</sub> (MAX) = (T<sub>J</sub> (MAX)-T<sub>A</sub>)/ $\theta_{JA}$ . Exceeding the maximum allowable power dissipation will cause excessive die temperature, and the regulator will go into thermal shutdown. Internal thermal shutdown circuitry protects the device from permanent damage.
- The device is not guaranteed to function outside of its operating conditions.
- Measured on JESD51-7, 4-layer PCB.

## ELECTRICAL CHARACTERISTICS <sup>(5)</sup>

$V_{IN} = V_{EN} = 3.6V$ ,  $T_A = +25^{\circ}C$ , unless otherwise noted.

Parameters	Condition	Min	Typ	Max	Units
Supply Current	$V_{EN} = V_{IN}$ , $V_{FB} = 0.9V$		600	750	$\mu A$
Shutdown Current	$V_{EN} = 0V$ , $V_{IN} = 6V$		0.01	1	$\mu A$
Thermal Shutdown Trip Threshold	Hysteresis = $20^{\circ}C$		150		$^{\circ}C$
EN Trip Threshold	$-40^{\circ}C \leq T_A \leq +85^{\circ}C$	0.3	1.0	1.5	V
EN Input Current	$V_{EN} = 0V$		0.1	1.0	$\mu A$
EN Input Current	$V_{EN} = 6V$		6		$\mu A$
IN Undervoltage Lockout Threshold	Rising Edge	2.15	2.40	2.65	V
IN Undervoltage Lockout Hysteresis			160		mV
Regulated FB Voltage	$T_A = +25^{\circ}C$ $-40^{\circ}C \leq T_A \leq +85^{\circ}C$	0.784 0.776	0.800 0.800	0.816 0.824	V
FB Input Bias Current	$V_{FB} = 0.8V$	-50	-2	+50	nA
SW PFET On Resistance	$I_{SW} = 100mA$	0.18	0.25	0.28	$\Omega$
SW NFET On Resistance	$I_{SW} = -100mA$	0.14	0.2	0.24	$\Omega$
SW Leakage Current	$V_{EN}=0V$ ; $V_{IN}=6V$ $V_{SW} = 0V$	-1	0.1	1	$\mu A$
SW Leakage Current	$V_{EN}=0V$ ; $V_{IN}=6V$ $V_{SW} = 6V$	-5	1.5	5	$\mu A$
SW PFET Peak Current Limit	Duty Cycle=100% Duty Cycle=50% <sup>(6)</sup>	2.1	3.0 3.5		A
Switching Frequency		1.0	1.2	1.4	MHz

### Notes:

5) Production test at  $+25^{\circ}C$ . Specifications over the temperature range are guaranteed by design and characterization.

## PIN FUNCTIONS

Pin #	Name	Description
1	FB	Feedback input. An external resistor divider from the output to GND, tapped to the FB pin sets the output voltage.
2	GND, Exposed Pad	Ground pin. Connect exposed pad to ground plane for proper thermal performance.
3	SW	Switch node to the inductor.
4	PVIN	Input supply pin for power FET.
5	VIN	Input Supply pin for controller. Put small decoupling ceramic near this pin.
6	EN	Enable input, "High" enables MP2012. EN is pulled to GND with 1Meg internal resistor.

## TYPICAL PERFORMANCE CHARACTERISTICS

$V_{IN} = 5V$ ,  $V_{OUT} = 1.8V$ ,  $L=3.3\mu H$ ,  $T_A = +25^\circ C$ , unless otherwise noted.

**Efficiency vs. Load Current**

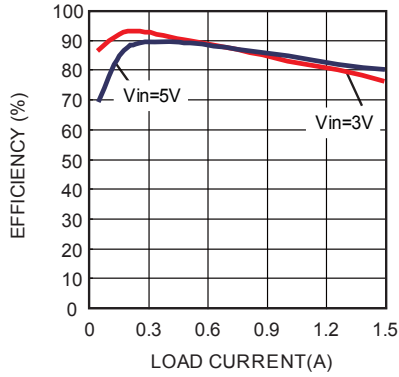

**Enable Supply Current vs. Input Voltage**

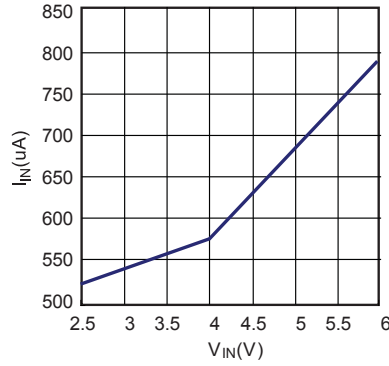

**Case Temperature Rise vs. Output Current**

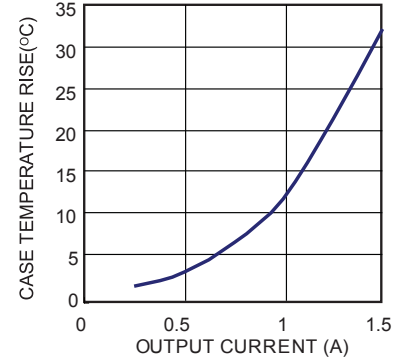

**Load Regulation**

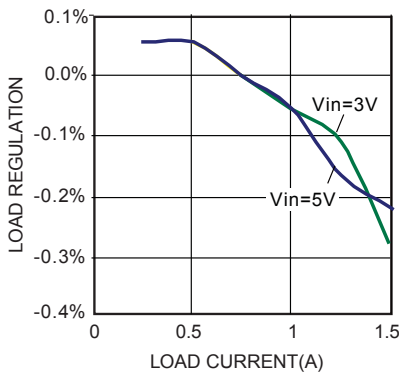

**Line Regulation**

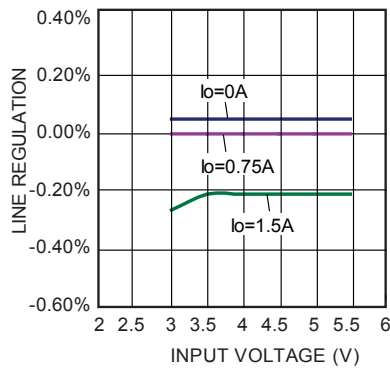

**Peak Current vs. Duty**

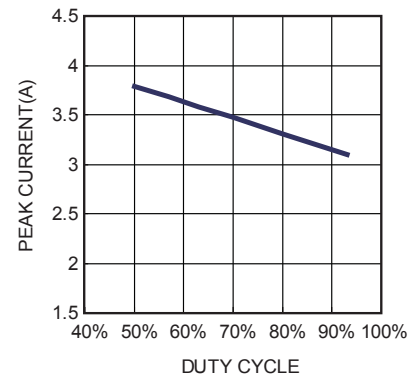

## TYPICAL PERFORMANCE CHARACTERISTICS

$V_{IN} = 5V$ ,  $V_{OUT} = 1.8V$ ,  $L = 3.3\mu H$ ,  $T_A = +25^\circ C$ , unless otherwise noted.

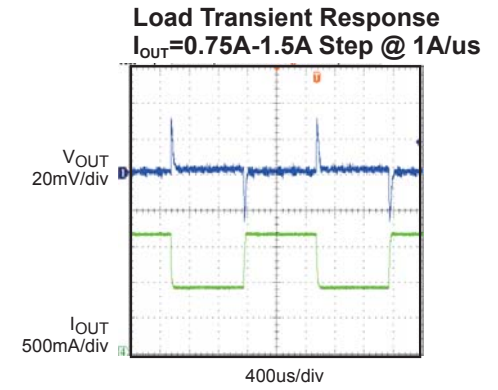
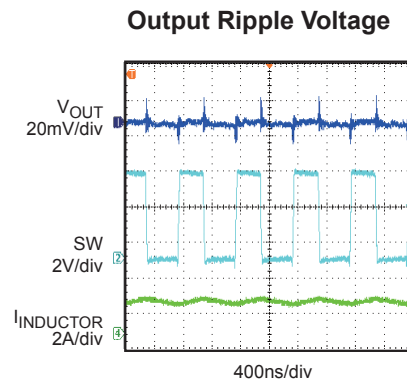
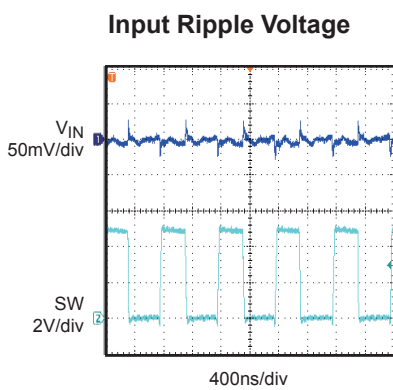
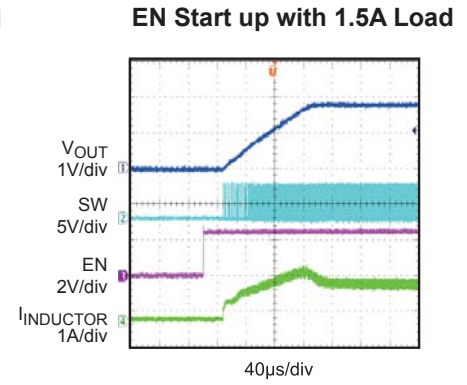
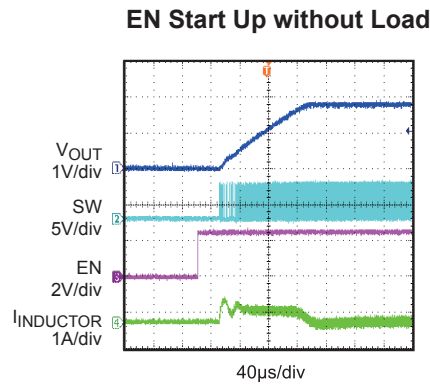
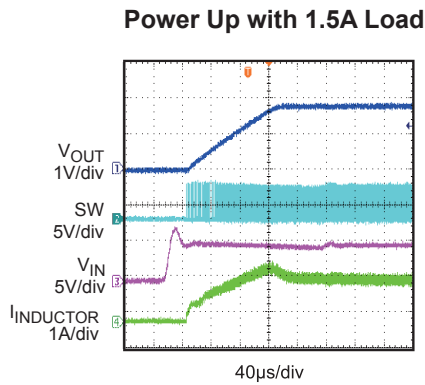
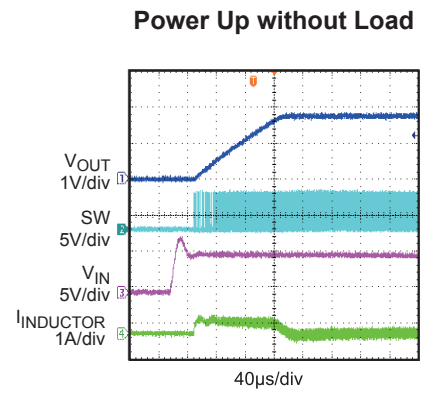
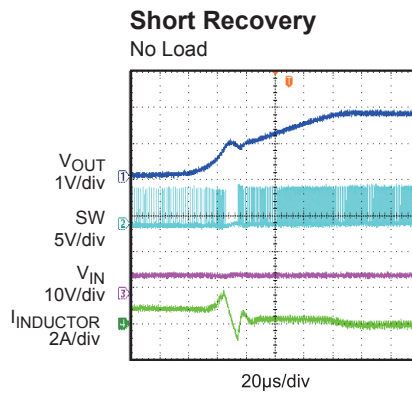
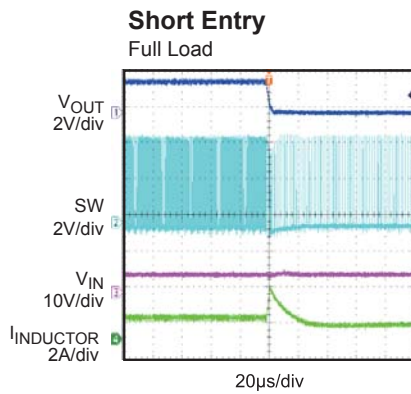

FUNCTION BLOCK DIAGRAM

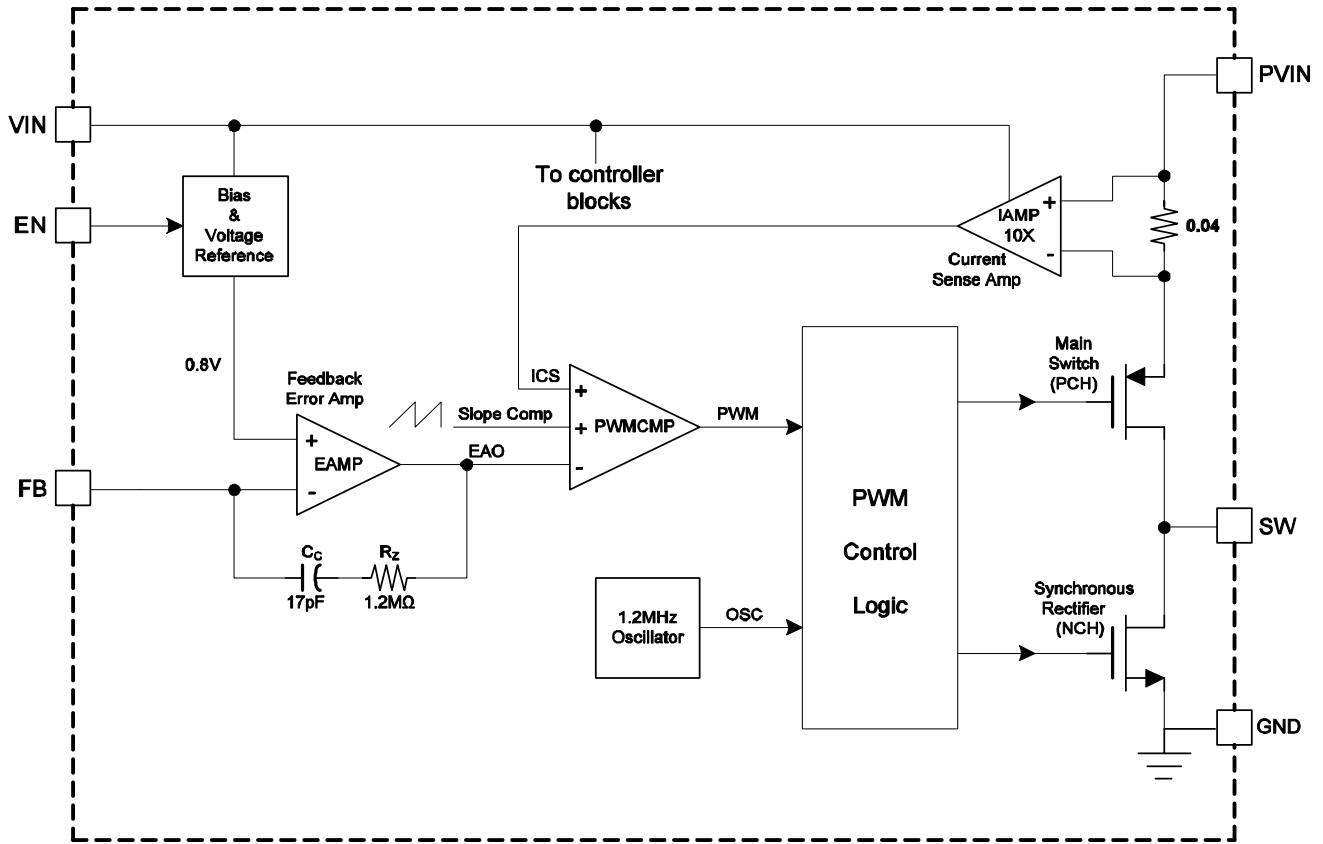

Figure 1—Function Block Diagram

## OPERATION

The MP2012 is a fixed frequency 1.2MHz current mode 1.5A step-down converter, optimized for low voltage, Li-Ion battery powered applications where high efficiency and small size are critical. MP2012 integrates a high side PFET main switch and a low side synchronous rectifier. It always operates in continuous conduction mode, simplifies the control scheme and eliminates the random spectrum noise due to discontinuous conduction mode.

The steady state duty cycle D for this mode can be calculated as:

$$D = T_{ON} \times f_{OSC} \times 100\% \approx \frac{V_{OUT}}{V_{IN}} \times 100\%$$

Where  $T_{ON}$  is the main switch on time and  $f_{OSC}$  is the oscillator frequency (1.2MHz typ.).

### Current Mode PWM Control

Slope compensated current mode PWM control provides stable switching and cycle-by-cycle current limiting for superior load and line response as well as protection of the internal main switch and synchronous rectifier. The MP2012 switches at a constant frequency (1.2MHz) and modulates the inductor peak current to regulate the output voltage. Specifically, for each cycle the PWM controller forces the inductor peak current to an internal reference level derived from the feedback error voltage. At normal operation, the main switch is turned on at each rise edge of the internal oscillator, and remains on for a certain period of time to ramp up the inductor current. As soon as the inductor current reaches the reference level, the main switch is turned off and immediately the synchronous rectifier will be turned on to provide the inductor current. In forced PWM mode, the synchronous rectifier will stay on until the next oscillator cycle.

### Dropout Operation

The MP2012 allows the main switch to remain on for more than one switching cycle to increase the duty cycle when the input voltage is dropping close to the output voltage. When the duty cycle reaches 100%, the main switch is held on continuously to deliver current to the output up to the PFET current limit. In this case, the output voltage becomes the input voltage minus the voltage drop across the main switch and the inductor.

### Maximum Load Current

The MP2012 can operate down to 2.5V input voltage; however the maximum load current decreases at lower input due to a large IR drop on the main switch and synchronous rectifier. The slope compensation signal reduces the peak inductor current as a function of the duty cycle to prevent sub-harmonic oscillations at duty cycles greater than 50%. Conversely, the current limit increases as the duty cycle decreases.

### Short Circuit Protection

When short circuit or over current condition happens, and FB is lower than about 0.3V, the MP2012 enters fold back mode. The oscillator frequency is reduced to prevent the inductor current from increasing beyond the PFET current limit. The PFET current limit is also reduced to lower the short circuit current. The frequency and current limit will return to the normal values once the short circuit condition is removed and the feedback voltage approaches 0.8V.

## APPLICATION INFORMATION

### Output Voltage Setting

The external resistor divider sets the output voltage.

$$V_{OUT} = 0.8 \times \left( 1 + \frac{R_1}{R_2} \right)$$

Rt is recommended when output voltage is high, as the Figure 2 shows.

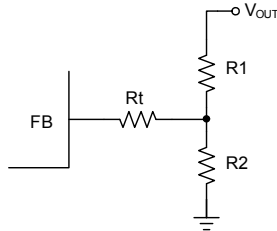

**Figure 2—Feedback Network**

Table 1 lists the recommended resistor value for common output voltages.

**Table 1—Resistor Selection vs. Output Voltage Setting**

V <sub>OUT</sub> /V	Rt/kΩ	R1/kΩ	R2/kΩ	L1/μH	C2/μF
1.2	300	4.99	10	2.2	22
1.8V	243	4.99	4.02	3.3	22
2.5V	100	121	57.6	3.3	22
3.3V	100	121	39	3.3	22

### Inductor Selection

A 1μH to 10μH inductor with DC current rating at least 25% higher than the maximum load current is recommended for most applications. For best efficiency, the inductor DC resistance shall be <200mΩ. See Table 2 for recommended inductors and manufacturers. For most designs, the inductance value can be derived from the following equation:

$$L = \frac{V_{OUT} \times (V_{IN} - V_{OUT})}{V_{IN} \times \Delta I_L \times f_{OSC}}$$

Where ΔI<sub>L</sub> is inductor ripple current. Choose inductor ripple current approximately 30% of the maximum load current, 1.5A.

The maximum inductor peak current is:

$$I_{L(MAX)} = I_{LOAD} + \frac{\Delta I_L}{2}$$

**Table 2—Suggested Inductors**

Manufacturer	Part Number	Inductance (μH)	Dimensions LxWxH (mm <sup>3</sup> )
Cooper	SD25-3R3	3.3	5.2X5.2X2.5
Toko	D63LCB#A921 CY-3R6M	3.6	6.3X6.2X3
TDK	SLF7045T- 3R3M2R5-PF	3.3	7X7X4.5

### Input Capacitor C<sub>IN</sub> Selection

The input capacitor reduces the surge current drawn from the input and switching noise from the device.

Ceramic capacitors with X5R or X7R dielectrics are highly recommended because of their low ESR and small temperature coefficients. For most applications, a 10μF capacitor is sufficient.

### Output Capacitor C<sub>OUT</sub> Selection

The output capacitor keeps output voltage ripple small and ensures regulation loop stable. The output capacitor impedance shall be low at the switching frequency. Ceramic capacitors with X5R or X7R dielectrics are recommended. For forced PWM mode operation, the output ripple ΔV<sub>OUT</sub> is approximately:

$$\Delta V_{OUT} = \frac{V_{OUT} \cdot (V_{IN} - V_{OUT})}{V_{IN} \cdot f_{OSC} \cdot L} \left( R_{ESR} + \frac{1}{8} \cdot \frac{1}{f_{OSC} \cdot C_{OUT}} \right)$$

For most applications, a 22μF capacitor is sufficient.

### Thermal Dissipation

Power dissipation shall be considered when operates MP2012 at maximum 1.5A output current. If the junction temperature rises above 150°C, MP2012 will be shut down by internal thermal protection circuitry.

The junction-to-ambient thermal resistance of the 6-pin QFN (3mm x 3mm) R<sub>OJA</sub> is 50°C/W. The maximum allowable power dissipation is about 1.6W when MP2012 is operating in a 70°C ambient temperature environment:

$$PD_{MAX} = \frac{150^\circ C - 70^\circ C}{50^\circ C/W} = 1.6W$$



### PC Board Layout

PCB layout is very important to achieve stable operation. Please follow these guidelines and take Figure2 for references.

The high current paths (GND, IN and SW) should be placed very close to the device with short,

direct and wide traces. Input capacitors should be placed as close as possible to the respective IN and GND pins. The external feedback resistors shall be placed next to the FB pins. Keep the switching nodes SW short and away from the feedback network.

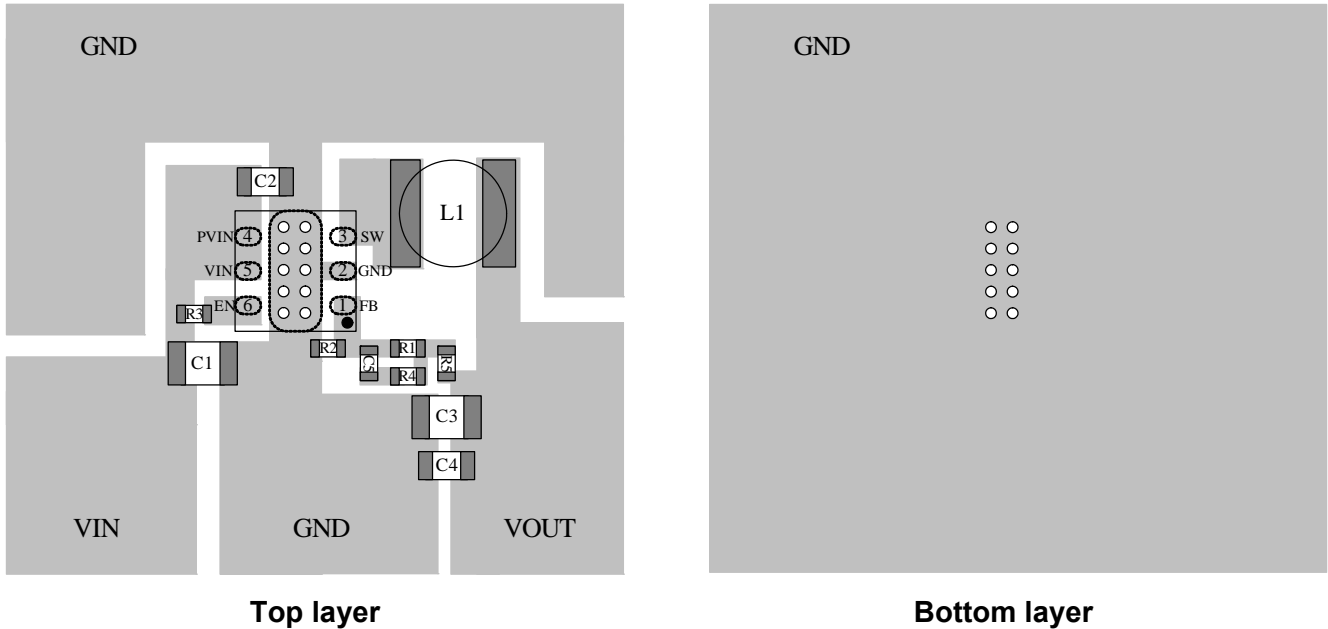

**Figure 3—PCB Layout**

## PACKAGE INFORMATION

### QFN6 (3mmx3mm)

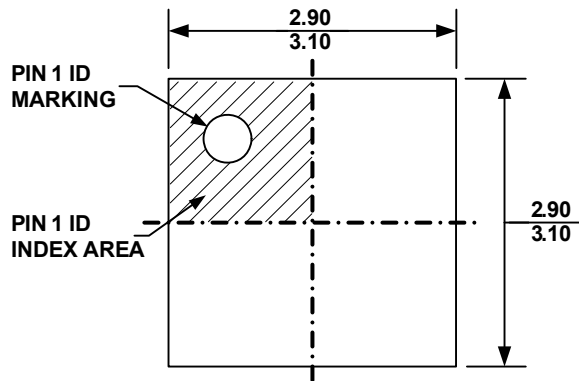

**TOP VIEW**

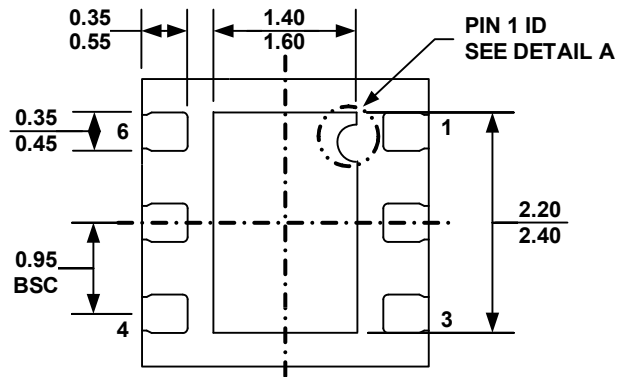

**BOTTOM VIEW**

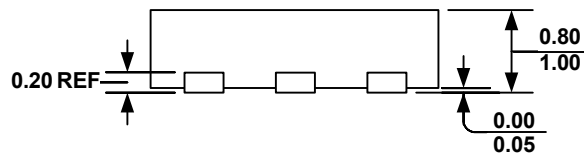

**SIDE VIEW**

**PIN 1 ID OPTION A**  
R0.20 TYP.

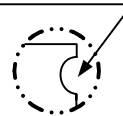

**PIN 1 ID OPTION B**  
R0.20 TYP.

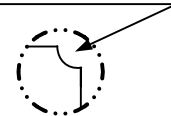

**DETAIL A**

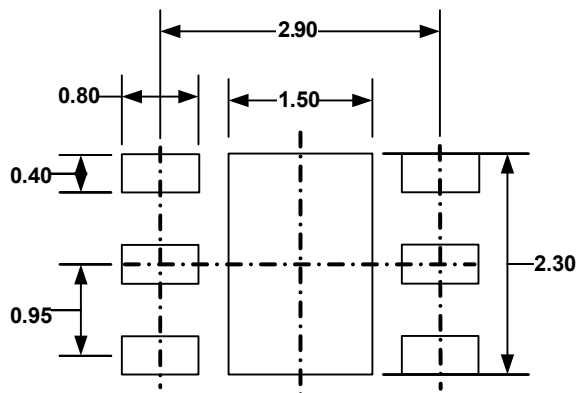

**RECOMMENDED LAND PATTERN**

**NOTE:**

- 1) ALL DIMENSIONS ARE IN MILLIMETERS
- 2) EXPOSED PADDLE SIZE DOES NOT INCLUDE MOLD FLASH
- 3) LEAD COPLANARITY SHALL BE 0.10 MILLIMETER MAX
- 4) JEDEC REFERENCE IS MO-229, VARIATION VEEA-2.
- 5) DRAWING IS NOT TO SCALE

**NOTICE:** The information in this document is subject to change without notice. Users should warrant and guarantee that third party Intellectual Property rights are not infringed upon when integrating MPS products into any application. MPS will not assume any legal responsibility for any said applications.



## Стандарт Электрон Связь

Мы молодая и активно развивающаяся компания в области поставок электронных компонентов. Мы поставляем электронные компоненты отечественного и импортного производства напрямую от производителей и с крупнейших складов мира.

Благодаря сотрудничеству с мировыми поставщиками мы осуществляем комплексные и плановые поставки широчайшего спектра электронных компонентов.

Собственная эффективная логистика и склад в обеспечивает надежную поставку продукции в точно указанные сроки по всей России.

Мы осуществляем техническую поддержку нашим клиентам и предпродажную проверку качества продукции. На все поставляемые продукты мы предоставляем гарантию .

Осуществляем поставки продукции под контролем ВП МО РФ на предприятия военно-промышленного комплекса России , а также работаем в рамках 275 ФЗ с открытием отдельных счетов в уполномоченном банке. Система менеджмента качества компании соответствует требованиям ГОСТ ISO 9001.

Минимальные сроки поставки, гибкие цены, неограниченный ассортимент и индивидуальный подход к клиентам являются основой для выстраивания долгосрочного и эффективного сотрудничества с предприятиями радиоэлектронной промышленности, предприятиями ВПК и научно-исследовательскими институтами России.

С нами вы становитесь еще успешнее!

### Наши контакты:

**Телефон:** +7 812 627 14 35

**Электронная почта:** [sales@st-electron.ru](mailto:sales@st-electron.ru)

**Адрес:** 198099, Санкт-Петербург,  
Промышленная ул, дом № 19, литера Н,  
помещение 100-Н Офис 331