

TINA2-RS

~14° spot beam. Assembly with holder, installation tape and location pins.

TECHNICAL SPECIFICATIONS:

Dimensions	Ø 16.0 mm
Height	9.5 mm
Fastening	tape, pin
ROHS compliant	yes ⓘ

MATERIAL SPECIFICATIONS:

Component	Type	Material	Colour	Finish
TINA2-RS	Single lens	PMMA	clear	
TINA2-HLD-BLK	Holder	PC	black	
TINA-TAPE3	Tape	PU tape	black	



ORDERING INFORMATION:

Component		Qty in box	MOQ	MPQ	Box weight (kg)
CA12374_TINA2-RS	Single lens	4140	230	230	8.3
» Box size: 451 x 241 x 298 mm					

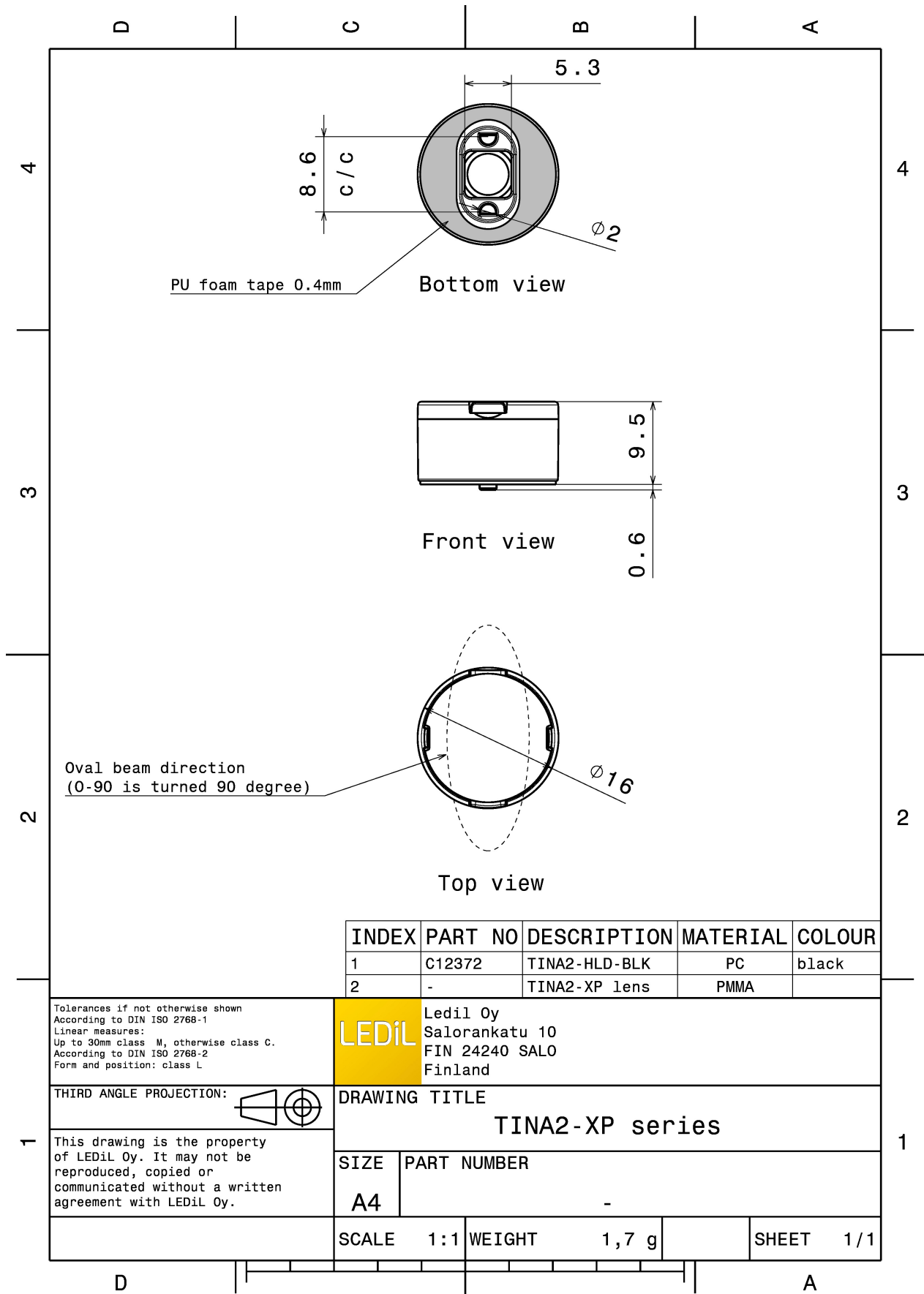

PHOTOMETRIC DATA (MEASURED):



LED XB-H
 FWHM 17.0°
 Efficiency 86 %
 Peak intensity 8.7 cd/lm
 LEDs/each optic 1
 Light colour White
 Required components:

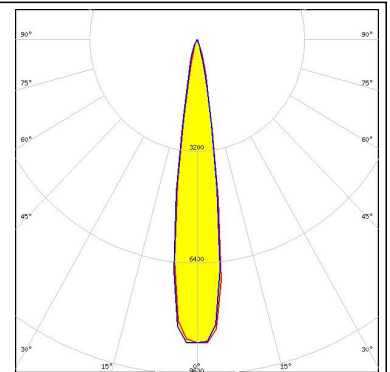

LED XQ-E HI
 FWHM 9.0°
 Efficiency 81 %
 Peak intensity 25 cd/lm
 LEDs/each optic 1
 Light colour White
 Required components:

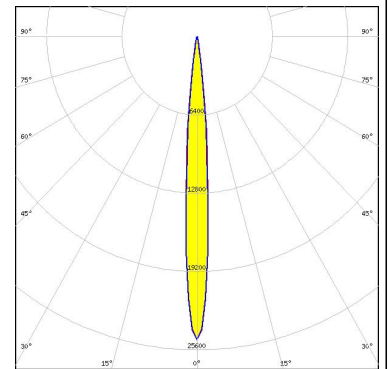

LED LUXEON TX
 FWHM 15.0°
 Efficiency 89 %
 Peak intensity 9.9 cd/lm
 LEDs/each optic 1
 Light colour White
 Required components:

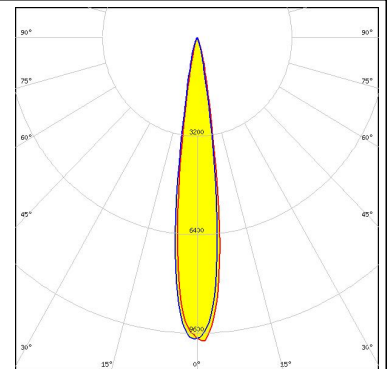
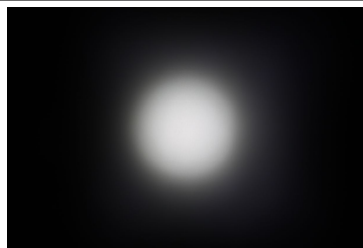

LED NVSxx19B/NVSxx19C
 FWHM 18.0°
 Efficiency 88 %
 Peak intensity 7 cd/lm
 LEDs/each optic 1
 Light colour White
 Required components:

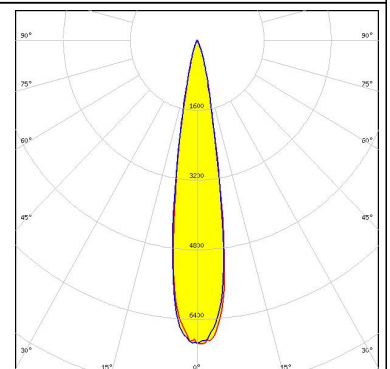

PHOTOMETRIC DATA (MEASURED):



LED NWSx229A
FWHM 25.0°
Efficiency 86 %
Peak intensity 3.6 cd/lm
LEDs/each optic 1
Light colour White
Required components:

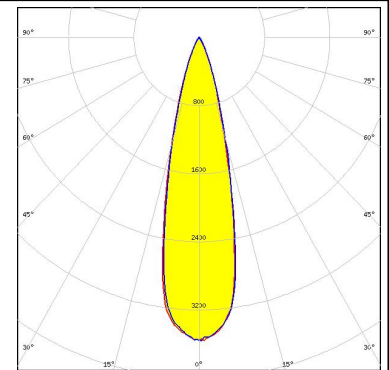

Osram Opto Semiconductors

LED OSOLON Square EC
FWHM 13.0°
Efficiency 88 %
Peak intensity 9.3 cd/lm
LEDs/each optic 1
Light colour White
Required components:



Osram Opto Semiconductors

LED OSOLON Square PC
FWHM 12.0°
Efficiency 88 %
Peak intensity 9.2 cd/lm
LEDs/each optic 1
Light colour White
Required components:



Osram Opto Semiconductors

LED OSOLON SSL 150
FWHM 11.0°
Efficiency 90 %
Peak intensity 19.5 cd/lm
LEDs/each optic 1
Light colour White
Required components:

PHOTOMETRIC DATA (MEASURED):

OSRAM
Opto Semiconductors

LED OSLON SSL 80
FWHM 10.0°
Efficiency 88 %
Peak intensity 16 cd/lm
LEDs/each optic 1
Light colour White
Required components:

OSRAM
Opto Semiconductors

LED SFH 4180S
FWHM 6.0°
Efficiency %
LEDs/each optic 1
Light colour IR
Required components:

OSRAM
Opto Semiconductors

LED SFH 4715S
FWHM 14.0°
Efficiency %
LEDs/each optic 1
Light colour White
Required components:

OSRAM
Opto Semiconductors

LED SFH 4716S
FWHM 11.0°
Efficiency %
LEDs/each optic 1
Light colour White
Required components:

PHOTOMETRIC DATA (MEASURED):



PHOTOMETRIC DATA (SIMULATED):

LUMILEDS

LED LUXEON C
 FWHM 11.0°
 Efficiency 92 %
 Peak intensity 14 cd/lm
 LEDs/each optic 1
 Light colour White
 Required components:

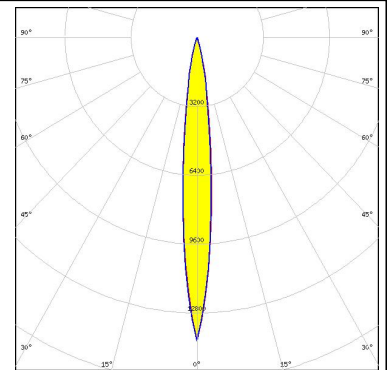

LUMILEDS

LED LUXEON IR Compact
 FWHM 10.0°
 Efficiency 87 %
 LEDs/each optic 1
 Light colour IR
 Required components:

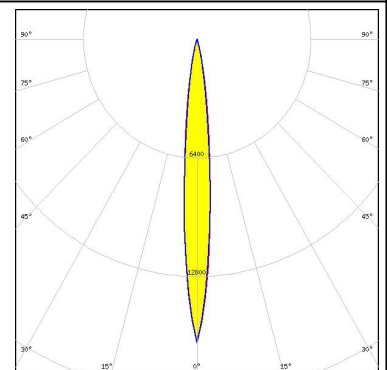

NICHIA

LED NFSx757G
 FWHM 10.0°
 Efficiency 93 %
 Peak intensity 16.7 cd/lm
 LEDs/each optic 1
 Light colour White
 Required components:

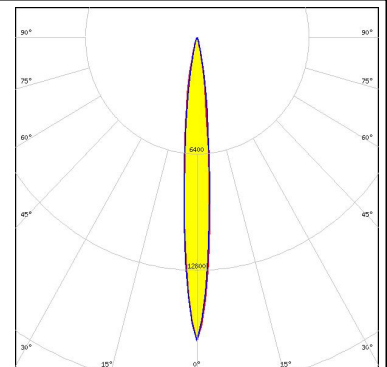

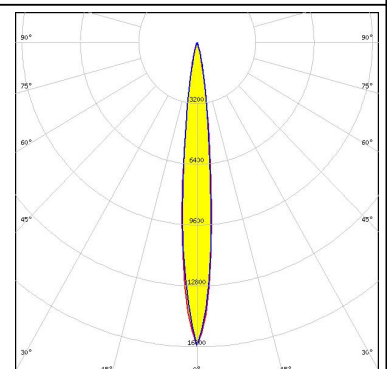

OSRAM Opto Semiconductors

LED OSCONIQ P 3030
 FWHM 12.0°
 Efficiency 91 %
 Peak intensity 16 cd/lm
 LEDs/each optic 1
 Light colour Blue
 Required components:

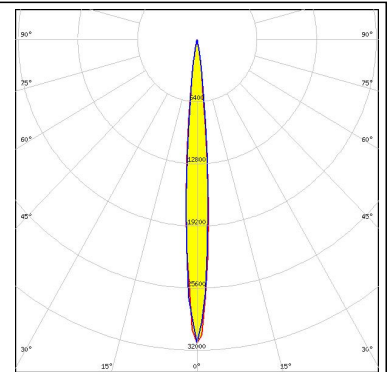

PHOTOMETRIC DATA (SIMULATED):

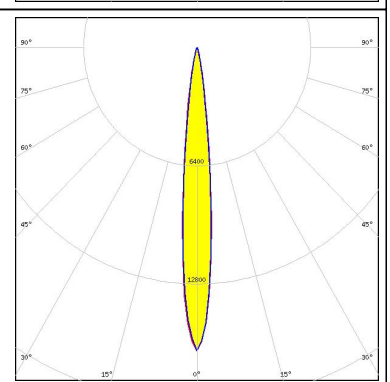
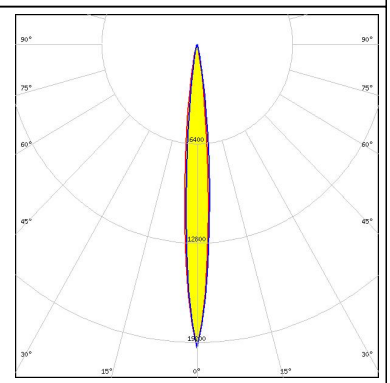
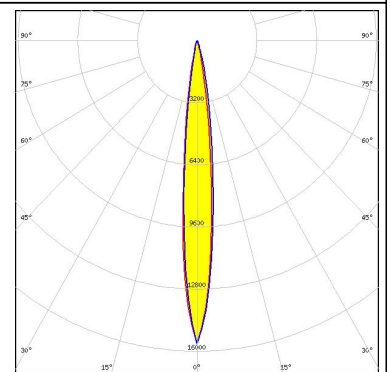
<p>OSRAM Opto Semiconductors</p> <p>LED: OSOLON Black Flat FWHM: 8.6° Efficiency: 92 % Peak intensity: 32.4 cd/lm LEDs/each optic: 1 Light colour: White Required components:</p>		
<p>OSRAM Opto Semiconductors</p> <p>LED: OSOLON Square Flat FWHM: 11.0° Efficiency: 91 % Peak intensity: 16.4 cd/lm LEDs/each optic: 1 Light colour: White Required components:</p>		
<p>OSRAM Opto Semiconductors</p> <p>LED: SFH 4170S FWHM: 10.0° Efficiency: 81 % LEDs/each optic: 1 Light colour: IR Required components:</p>		
<p>OSRAM Opto Semiconductors</p> <p>LED: SFH 4770S FWHM: 13.0° Efficiency: 92 % LEDs/each optic: 1 Light colour: IR Required components:</p>		

PHOTOMETRIC DATA (SIMULATED):

OSRAM

Opto Semiconductors

LED Synios P2720 1 mm
 FWHM 10.0°
 Efficiency 92 %
 Peak intensity 20.3 cd/lm
 LEDs/each optic 1
 Light colour White
 Required components:

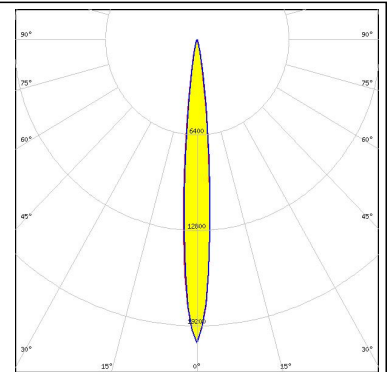

OSRAM

Opto Semiconductors

LED Synios P2720 1/2 mm
 FWHM 9.0°
 Efficiency 92 %
 Peak intensity 24 cd/lm
 LEDs/each optic 1
 Light colour White
 Required components:

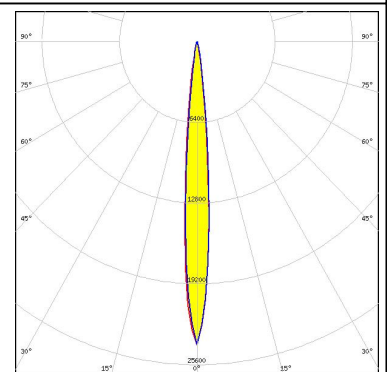

OSRAM

Opto Semiconductors

LED Synios P2720 1/4 mm
 FWHM 8.0°
 Efficiency 92 %
 Peak intensity 27.5 cd/lm
 LEDs/each optic 1
 Light colour White
 Required components:

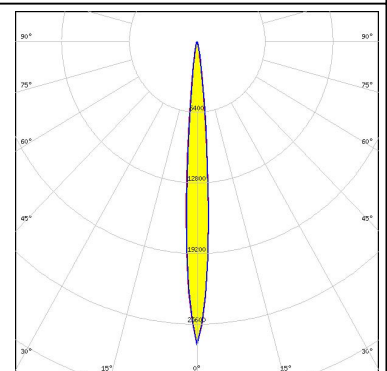

GENERAL INFORMATION:

NOTE: The typical beam angle will be changed by different color, chip size and chip position tolerance. The typical total beam angle is the full angle measured where the luminous intensity is half of the peak value.

MATERIALS:

As part of our continuous research and improvement processes, and to ensure the best possible quality and availability of our products, LEDiL reserves the right to change material grades without notice.

PRODUCT DATA USER AGREEMENT AND DISCLAIMER:

The measured data in the provided downloadable LEDiL Product Datasheets and Mechanical 2D-Drawings is rounded and provided as reference for planning. LEDiL Oy's optical specifications have been verified by conducting performance testing of the products in accordance with the company's quality system. The reported data are averaged results of multiple measurements with typical variation. LEDiL Oy reserves the right to without prior notification make changes and improvements to its products.

LEDiL Oy assumes neither warranty, nor guarantee nor any other liability of any kind for the contents and correctness of the provided data. The provided data has been generated with highest diligence but the provided data may in reality not represent the complete possible variation range of all intrinsic parameters. Therefore, in certain cases a deviation from the provided data could occur.

LEDiL Oy reserves the right to undertake technical changes of its products without further notification which could lead to changes in the provided data. LEDiL Oy assumes no liability of any kind for the possible deviation from any provided data or any other damage resulting from the usage of the provided data.

The user agrees to this disclaimer and user agreement with the download or usage of the provided files.

LEDiL Oy

Joensuunkatu 13
FI-24240 SALO
Finland

LEDiL Inc.

228 West Page Street
Suite D
Sycamore IL 60178
USA

Local sales and technical support

[www.ledil.com/
where_to_buy](http://www.ledil.com/where_to_buy)

Shipping locations

Salo, Finland
Hong Kong, China

Distribution Partners

[www.ledil.com/
where_to_buy](http://www.ledil.com/where_to_buy)



Стандарт Электрон Связь

Мы молодая и активно развивающаяся компания в области поставок электронных компонентов. Мы поставляем электронные компоненты отечественного и импортного производства напрямую от производителей и с крупнейших складов мира.

Благодаря сотрудничеству с мировыми поставщиками мы осуществляем комплексные и плановые поставки широчайшего спектра электронных компонентов.

Собственная эффективная логистика и склад в обеспечивает надежную поставку продукции в точно указанные сроки по всей России.

Мы осуществляем техническую поддержку нашим клиентам и предпродажную проверку качества продукции. На все поставляемые продукты мы предоставляем гарантию .

Осуществляем поставки продукции под контролем ВП МО РФ на предприятия военно-промышленного комплекса России , а также работаем в рамках 275 ФЗ с открытием отдельных счетов в уполномоченном банке. Система менеджмента качества компании соответствует требованиям ГОСТ ISO 9001.

Минимальные сроки поставки, гибкие цены, неограниченный ассортимент и индивидуальный подход к клиентам являются основой для выстраивания долгосрочного и эффективного сотрудничества с предприятиями радиоэлектронной промышленности, предприятиями ВПК и научно-исследовательскими институтами России.

С нами вы становитесь еще успешнее!

Наши контакты:

Телефон: +7 812 627 14 35

Электронная почта: sales@st-electron.ru

Адрес: 198099, Санкт-Петербург,
Промышленная ул, дом № 19, литера Н,
помещение 100-Н Офис 331