

4 x 50 W differential power amplifier with full I²C diagnostics, high efficiency and low voltage operation

Datasheet - production data

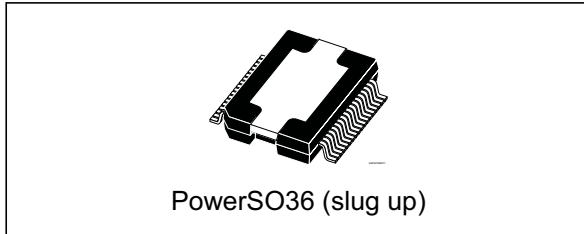

Features

- Multipower BCD technology
- MOSFET output power stage
- DMOS power output
- Differential input
- Class SB high efficiency
- High output power capability:
 - 4x28 W/4 Ω @ 14.4 V, f = 1 kHz, 10% THD
 - 4x50 W/2 Ω @ 14.4 V, f = 1 kHz, 10% THD
- Max power 4 x 75 W / 2 Ω
- Full I²C bus driving:
 - Standby
 - Independent front/rear soft play/mute
 - Selectable gain 26 dB /16 dB (for low noise line output function)
 - High efficiency enable/disable
 - I²C bus digital diagnostics (including DC bus AC load detection)
- Fault detection through integrated diagnostics
- DC offset detection
- Four independent short circuit protection

- Clipping detector pin with selectable threshold (2 %/10 %)
- Standby/mute pin
- Linear thermal shutdown with multiple thermal warning
- ESD protection
- Very robust against any kind of misconnection
- Improved SVR suppression during battery transients
- Capable to play down to 6 V (e.g. “Start-stop”)

Description

The TDA7569BDLVPD is the most advanced BCD technology quad bridge car radio amplifier, including a wide range of innovative features.

The TDA7569BDLVPD is equipped with the most complete diagnostics array that communicates the status of each speaker through the I²C bus. The differential input stage improves the disturbance rejection.

The dissipated output power under average listening condition is significantly reduced when compared to the conventional class AB solutions, thanks to the innovative internal design. Moreover it has been designed to be very robust against several kinds of misconnections.

It is moreover compliant to the most recent OEM specifications for low voltage operation (so called 'start-stop' battery profile during engine stop), helping car manufacturers to reduce the overall emissions and thus contributing to environment protection.

Table 1. Device summary

Order code	Package	Packing
TDA7569BDLVPD	PowerSO36	Tube
TDA7569BDLVPDTR	PowerSO36	Tape and reel

Contents

1	Block diagram and application circuit	6
2	Pin description	7
3	Electrical specifications	9
3.1	Absolute maximum ratings	9
3.2	Thermal data	9
3.3	Electrical characteristics	10
3.4	Electrical characteristics curves	14
4	Diagnostics functional description	17
4.1	Turn-on diagnostic	17
4.2	Permanent diagnostics	19
4.3	Output DC offset detection	20
4.4	AC diagnostic	20
5	Multiple faults	22
5.1	Faults availability	22
6	Thermal protection	23
6.1	Fast muting	23
7	Battery transition management	24
7.1	Low voltage (“start stop”) operation	24
7.2	Advanced battery management	25
8	Application suggestions	26
8.1	High efficiency introduction	26
9	I²C bus	27
9.1	I ² C programming/reading sequences	27
9.2	Address selection and I ² C disable	27
9.3	I ² C bus interface	27

9.3.1	Data validity	27
9.3.2	Start and stop conditions	28
9.3.3	Byte format	28
9.3.4	Acknowledge	28
10	Software specifications	29
11	Examples of bytes sequence	34
12	Package information	35
13	Revision history	36

List of tables

Table 1.	Device summary	1
Table 2.	Pin list description	7
Table 3.	Absolute maximum ratings	9
Table 4.	Thermal data	9
Table 5.	Electrical characteristics	10
Table 6.	Double fault table for turn on diagnostic	22
Table 7.	IB1	29
Table 8.	IB2	30
Table 9.	DB1	30
Table 10.	DB2	31
Table 11.	DB3	32
Table 12.	DB4	33
Table 13.	Document revision history	36

List of figures

Figure 1.	Block diagram	6
Figure 2.	Application circuit	6
Figure 3.	Pin connection diagram (top of view)	7
Figure 4.	Quiescent current vs. supply voltage	14
Figure 5.	Output power vs. supply voltage (4 Ω)	14
Figure 6.	Distortion vs. output power (4 Ω , STD)	14
Figure 7.	Distortion vs. output power (4 Ω , HI-EFF)	14
Figure 8.	Distortion vs. output power (2 Ω , STD)	14
Figure 9.	Distortion vs. output power (2 Ω , HI-EFF)	14
Figure 10.	Distortion vs. frequency (2 Ω)	15
Figure 11.	Distortion vs. output power $V_s = 6$ V (4 Ω , STD)	15
Figure 12.	Distortion vs. frequency (4 Ω)	15
Figure 13.	Crosstalk vs. frequency	15
Figure 14.	Supply voltage rejection vs. frequency	15
Figure 15.	Power dissipation vs. average output power (audio program simulation, 2 Ω)	15
Figure 16.	Power dissipation vs. average output power (audio program simulation, 4 Ω)	16
Figure 17.	Total power dissipation and efficiency vs. output power (4 Ω , HI-EFF, Sine)	16
Figure 18.	Total power dissipation and efficiency vs. output power (4 Ω , STD, Sine)	16
Figure 19.	ITU R-ARM frequency response, weighting filter for transient pop	16
Figure 20.	Turn - on diagnostic: working principle	17
Figure 21.	SVR and output behavior (Case 1: without turn-on diagnostic)	17
Figure 22.	SVR and output pin behavior (Case 2: with turn-on diagnostic)	18
Figure 23.	Short circuit detection thresholds	18
Figure 24.	Load detection thresholds - high gain setting	18
Figure 25.	Load detection threshold - low gain setting	18
Figure 26.	Restart timing without diagnostic enable (permanent)	19
Figure 27.	Restart timing with diagnostic enable (permanent)	19
Figure 28.	Current detection high: load impedance $ Z $ vs. output peak voltage	21
Figure 29.	Current detection low: load impedance $ Z $ vs. output peak voltage	21
Figure 30.	Thermal foldback diagram	23
Figure 31.	Worst case battery cranking curve sample 1	24
Figure 32.	Worst case battery cranking curve sample 2	24
Figure 33.	Upwards fast battery transitions diagram	25
Figure 34.	High efficiency - basic structure	26
Figure 35.	Data validity on the I ² C bus	28
Figure 36.	Timing diagram on the I ² C bus	28
Figure 37.	Acknowledge on the I ² C bus	28
Figure 38.	PowerSO36 (slug up) mechanical data and package dimensions	35

1 Block diagram and application circuit

Figure 1. Block diagram

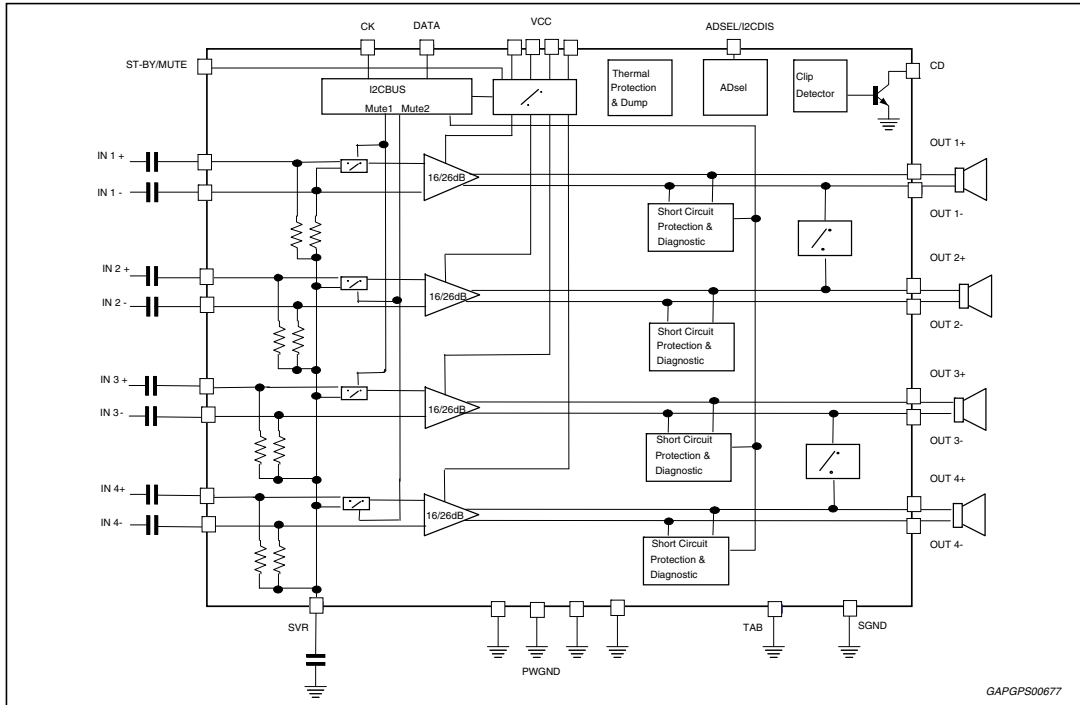
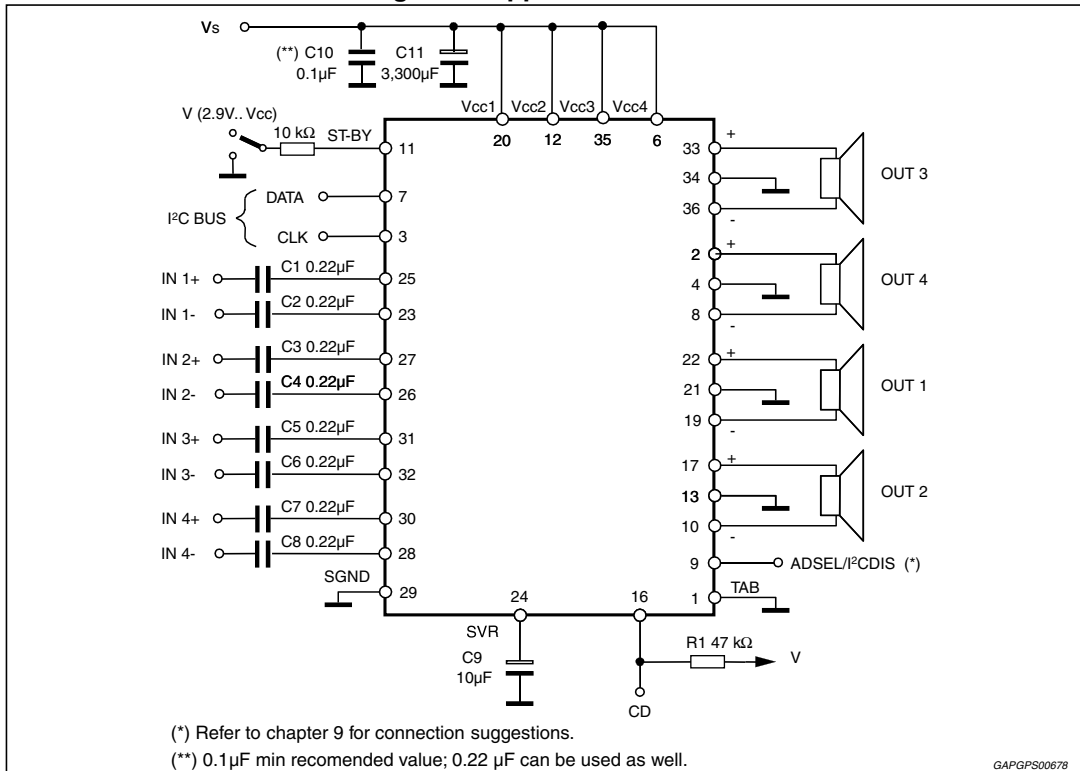
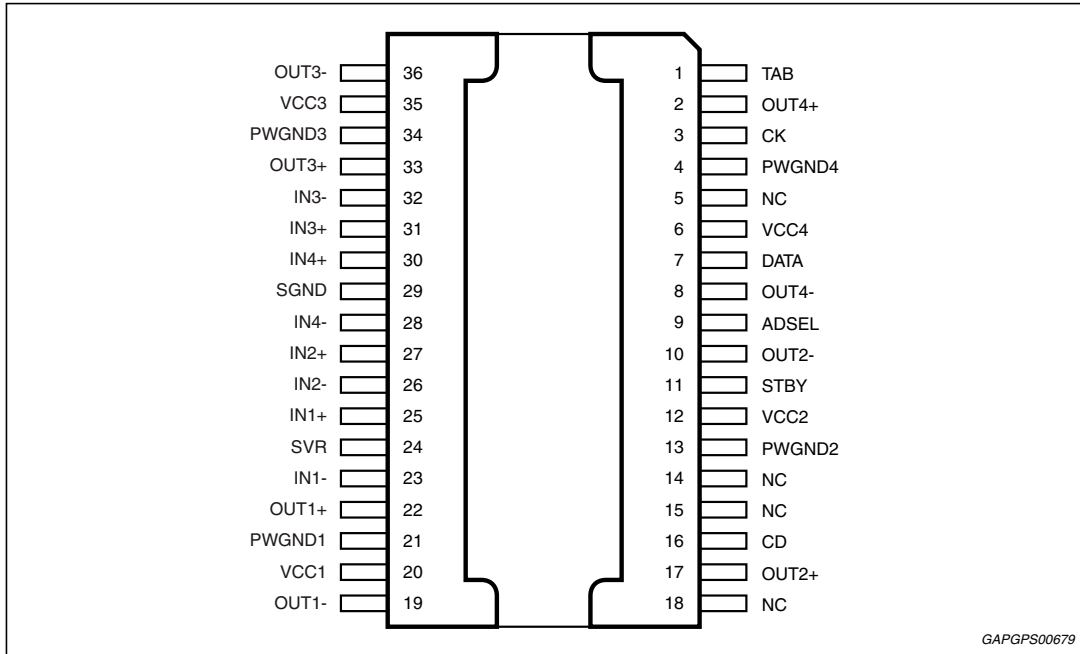

Figure 2. Application circuit



2 Pin description

Figure 3. Pin connection diagram (top of view)



GAPGPS00679

For channel name reference: CH1 = LF, CH2 = LR, CH3 = RF, CH4 = RR.

Table 2. Pin list description

Pin #	Pin name	Function
1	TAB	-
2	OUT4+	Channel 4, + output
3	CK	I ² C bus clock/HE selector
4	PWGND4	Channel 4 output power ground
5	NC	Not connected
6	VCC4	Supply voltage pin 4
7	DATA	I ² C bus data pin/gain selector
8	OUT4-	Channel 4, - output
9	ADSEL	Address selector pin/ I ² C bus disable (legacy select)
10	OUT2-	Channel 2, - output
11	STBY	Standby pin
12	VCC2	Supply voltage pin 2
13	PWGND2	Channel 2 output power ground
14	NC	Not connected
15	NC	Not connected
16	CD	Clip detector output pin

Table 2. Pin list description (continued)

Pin #	Pin name	Function
17	OUT2+	Channel 2, + output
18	NC	Not connected
19	OUT1-	Channel 1, - output
20	VCC1	Supply voltage pin1
21	PWGND1	Channel 1 output power ground
22	OUT1+	Channel 1, + output
23	IN1-	Channel 1, -input
24	SVR	SVR pin
25	IN1+	Channel 1, +input
26	IN2-	Channel 2, -input
27	IN2+	Channel 2, +input
28	IN4-	Channel 4, -input
29	SGND	Signal ground pin
30	IN4+	Channel 4, +input
31	IN3+	Channel 3, +input
32	IN3-	Channel 3, -input
33	OUT3+	Channel 3, + output
34	PWGND3	Channel 3 output power ground
35	VCC3	Supply voltage pin 3
36	OUT3-	Channel 3, - output

3 Electrical specifications

3.1 Absolute maximum ratings

Table 3. Absolute maximum ratings

Symbol	Parameter	Value	Unit
V_{op}	Operating supply voltage ⁽¹⁾	18	V
V_S	DC supply voltage	28	V
V_{peak}	Peak supply voltage (for $t_{max} = 50$ ms)	50	V
GNDmax	Ground pins voltage	-0.3 to 0.3	V
V_{CK}, V_{DATA}, V_{CD}	CK, CD and DATA pin voltage	-0.3 to 5.5	V
V_{stby}	STBY pin voltage	-0.3 to V_{op}	V
I_O	Output peak current (not repetitive $t_{max} = 100$ ms)	8	A
	Output peak current (repetitive $f > 10$ kHz)	6	
P_{tot}	Power dissipation $T_{case} = 70^\circ\text{C}$ ⁽²⁾	80	W
T_{stg}, T_j	Storage and junction temperature ⁽³⁾	-55 to 150	$^\circ\text{C}$
T_{amb}	Operative temperature range	-40 to 105	$^\circ\text{C}$

- For $R_L = 2 \Omega$, the output current limit can be reached at $V_{op} > 16$ V (internal self-protections can be triggered).
- This is max theoretical value, for power dissipation in real application conditions please refer to curves reported in [Section 3.4: Electrical characteristics curves](#).
- A suitable heatsink/dissipation system should be used to keep T_j inside the specified limits.

3.2 Thermal data

Table 4. Thermal data

Symbol	Parameter	Value	Unit
$R_{th j-case}$	Thermal resistance junction-to-case Max.	1	$^\circ\text{C/W}$

3.3 Electrical characteristics

Refer to the test circuit, $V_S = 14.4\text{ V}$; $R_L = 4\ \Omega$; $f = 1\text{ kHz}$; $G_V = 26\text{ dB}$; $T_{\text{amb}} = 25\text{ }^\circ\text{C}$; unless otherwise specified.

Tested at $T_{\text{amb}} = 25\text{ }^\circ\text{C}$ and $T_{\text{hot}} = 105\text{ }^\circ\text{C}$; functionality guaranteed for $T_J = -40\text{ }^\circ\text{C}$ to $150\text{ }^\circ\text{C}$.

Table 5. Electrical characteristics

Symbol	Parameter	Test condition	Min.	Typ.	Max.	Unit
General characteristics						
V_S	Supply voltage range	$R_L = 4\ \Omega$	6	-	18	V
		$R_L = 2\ \Omega$	6	-	16 ⁽¹⁾	V
I_d	Total quiescent drain current	-	-	160	250	mA
R_{IN}	Input impedance (differential)	-	90	115	140	K Ω
V_{AM}	Min. supply mute threshold	IB1(D7) = 1; Signal attenuation -6 dB	7	-	8	V
		IB1(D7) = 0 (default); ⁽²⁾ Signal attenuation -6 dB	5	-	5.8	
V_{OS}	Offset voltage	Mute & play	-80	-	80	mV
V_{dth}	Dump threshold	-	18.5	-	20.5	V
I_{SB}	Standby current	$V_{\text{standby}} = 0$	-	1	5	μA
SVR	Supply voltage rejection	$f = 100\text{ Hz to }10\text{ kHz}$; $V_r = 1\text{ Vpk}$; $R_g = 600\ \Omega$	60	70	-	dB
T_{ON}	Turn on timing (Mute play transition)	D2/D1 (IB1) 0 to 1	-	25	40	ms
T_{OFF}	Turn off timing (Play mute transition)	D2/D1 (IB1) 1 to 0	-	25	40	ms
TH_{WARN1}	Average junction temperature for TH warning 1	DB1 (D7) = 1	-	160	-	$^\circ\text{C}$
TH_{WARN2}	Average junction temperature for TH warning 2	DB4 (D7) = 1	-	145	-	
TH_{WARN3}	Average junction temperature for TH warning 3	DB4 (D6) = 1	-	125	-	
Audio performances						
P_O	Output power	Max. power ⁽³⁾ $V_S = 15.2\text{ V}$, $R_L = 4\ \Omega$	-	50	-	W
		THD = 10 %, $R_L = 4\ \Omega$	25	28	-	W
		THD = 1 %, $R_L = 4\ \Omega$	20	22	-	W
		$R_L = 2\ \Omega$; THD 10 %	40	50	-	W
		$R_L = 2\ \Omega$; THD 1 %	32	40	-	W
		$R_L = 2\ \Omega$; Max. power ⁽³⁾ $V_S = 14.4\text{ V}$	60	75	-	W
	Max power@ $V_S = 6\text{ V}$, $R_L = 4\ \Omega$	-	6	-	W	

Table 5. Electrical characteristics (continued)

Symbol	Parameter	Test condition	Min.	Typ.	Max.	Unit
THD	Total harmonic distortion	$P_O = 1 \text{ W to } 10 \text{ W}$; STD mode	-	0.015	0.1	%
		HE MODE; $P_O = 1.5 \text{ W}$	-	0.05	0.1	%
		HE MODE; $P_O = 8 \text{ W}$	-	0.1	0.5	%
		$P_O = 1\text{-}10 \text{ W}$, $f = 10 \text{ kHz}$	-	0.15	0.5	%
		$G_V = 16 \text{ dB}$; STD Mode $V_O = 0.1 \text{ to } 5 \text{ VRMS}$	-	0.02	0.05	%
C_T	Cross talk	$f = 1 \text{ kHz to } 10 \text{ kHz}$, $R_g = 600 \Omega$	50	70	-	dB
G_{V1}	Voltage gain 1	-	25	26	27	dB
ΔG_{V1}	Voltage gain match 1	-	-1	-	1	dB
G_{V2}	Voltage gain 2	-	15	16	17	dB
ΔG_{V2}	Voltage gain match 2	-	-1	-	1	dB
E_{IN1}	Output noise voltage 1	$R_g = 600 \Omega$ 20 Hz to 22 kHz	-	45	60	μV
E_{IN2}	Output noise voltage 2	$R_g = 600 \Omega$; $G_V = 16 \text{ dB}$ 20 Hz to 22 kHz	-	20	30	μV
BW	Power bandwidth	-	100	-	-	kHz
CMRR	Input CMRR	$V_{CM} = 1 \text{ Vpk-pk}$; $R_g = 0 \Omega$	-	70	-	dB
ΔV_{OITU}	ITU Pop filter output voltage	Standby to Mute and Mute to Standby transition $T_{amb} = 25 \text{ }^\circ\text{C}$, ITU-R 2K, $C_{svr} = 10 \mu\text{F}$ $V_s = 14.4 \text{ V}$	-7.5	-	+7.5	mV
		Mute to Play transition $T_{amb} = 25 \text{ }^\circ\text{C}$, ITU-R 2K, $V_s = 14.4 \text{ V}^{(4)}$	-7.5	-	+7.5	mV
		Play to Mute transition $T_{amb} = 25 \text{ }^\circ\text{C}$, ITU-R 2K, $V_s = 14.4 \text{ V}^{(5)}$	-7.5	-	+7.5	mV
Clip detector						
CD_{LK}	Clip det. high leakage current	CD off / $V_{CD} = 5.5 \text{ V}$	-	0	5	μA
CD_{SAT}	Clip det sat. voltage	CD on; $I_{CD} = 1 \text{ mA}$	-	-	300	mV
CD_{THD}	Clip det THD level	D0 (IB1) = 1	5	10	15	%
		D0 (IB1) = 0	1	2	3	%
Control pin characteristics						
V_{SBY}	Standby/mute pin for standby	-	0	-	1.2	V
V_{MU}	Standby/mute pin for mute	-	2.9	-	3.5	V
V_{OP}	Standby/mute pin for operating	-	4.5	-	18	V

Table 5. Electrical characteristics (continued)

Symbol	Parameter	Test condition	Min.	Typ.	Max.	Unit
I _{MU}	Standby/mute pin current	V _{st-by/mute} = 4.5 V	-	1	5	μA
		V _{st-by/mute} < 1.2 V	-	0	5	μA
A _{SB}	Standby attenuation	-	90	110	-	dB
A _M	Mute attenuation	-	80	100	-	dB
Turn on diagnostics 1 (Power amplifier mode)						
Pgnd	Short to GND det. (below this limit, the Output is considered in short circuit to GND)	Power amplifier in standby	-	-	1.2	V
Pvs	Short to Vs det. (above this limit, the output is considered in short circuit to Vs)		Vs -1.2	-	-	V
Pnop	Normal operation thresholds. (Within these limits, the output is considered without faults).		1.8	-	Vs -1.8	V
Lsc	Shorted load det.		-	-	0.5	Ω
Lop	Open load det.		85	-	-	Ω
Lnop	Normal load det.		1.5	-	45	Ω
Turn on diagnostics 2 (Line driver mode)						
Pgnd	Short to GND det. (below this limit, the output is considered in short circuit to GND)	Power amplifier in standby	-	-	1.2	V
Pvs	Short to Vs det. (above this limit, the output is considered in short circuit to Vs)	-	Vs -1.2	-	-	V
Pnop	Normal operation thresholds. (Within these limits, the output is considered without faults).	-	1.8	-	Vs -1.8	V
Lsc	Shorted load det.	-	-	-	1.5	Ω
Lop	Open load det.	-	330	-	-	Ω
Lnop	Normal load det.	-	7	-	180	Ω
Permanent diagnostics 2 (Power amplifier mode or line driver mode)						
Pgnd	Short to GND det. (below this limit, the Output is considered in short circuit to GND)	Power amplifier in mute or play, one or more short circuits protection activated	-	-	1.2	V
Pvs	Short to Vs det. (above this limit, the output is considered in short circuit to Vs)		Vs -1.2	-	-	V
Pnop	Normal operation thresholds. (Within these limits, the output is considered without faults).		1.8	-	Vs -1.8	V

Table 5. Electrical characteristics (continued)

Symbol	Parameter	Test condition	Min.	Typ.	Max.	Unit
L _{SC}	Shorted load det.	Power amplifier mode	-	-	0.5	Ω
		Line driver mode	-	-	1.5	Ω
V _O	Offset detection	Power amplifier in play, AC input signals = 0	±1.5	±2	±2.5	V
I _{NLH}	Normal load current detection	V _O < (V _S -5)pk, IB2 (D7) = 0	500	-	-	mA
I _{OLH}	Open load current detection		-	-	250	mA
I _{NLL}	Normal load current detection	V _O < (V _S -5)pk, IB2 (D7) = 1	250	-	-	mA
I _{OLL}	Open load current detection		-	-	125	mA
I²C bus interface						
S _{CL}	Clock frequency	-	-	-	400	kHz
V _{IL}	Input low voltage	-	-	-	1.5	V
V _{IH}	Input high voltage	-	2.3	-	-	V

- When V_S > 16 V the output current limit is reached (triggering embedded internal protections).
- In legacy mode only low threshold option is available.
- Saturated square wave output.
- Voltage ramp on STBY pin:
from 3.3 V to 4.2 V in t ≥ 40 ms.
In case of I²C mode command IB1(D1) = 1 (Mute → Unmute rear channels) and/or IB1(D2) = 1 (Mute → Unmute front channels) must be transmitted before to start the voltage ramp on STBY pin.
- Voltage ramp on STBY pin:
from 4.05 V to 3.55 V in t ≥ 40 ms.
In case of I²C mode command IB1(D1) = 0 (Unmute → Mute rear channels) and/or IB1(D2) = 0 (Unmute → Mute front channels) must be NOT transmitted before to start the voltage ramp on STBY pin.

3.4 Electrical characteristics curves

Figure 4. Quiescent current vs. supply voltage

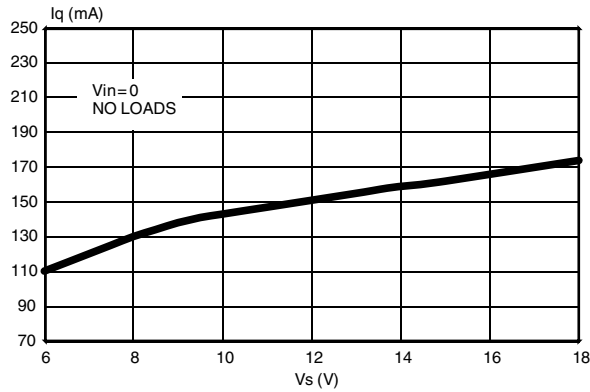

Figure 5. Output power vs. supply voltage (4 Ω)

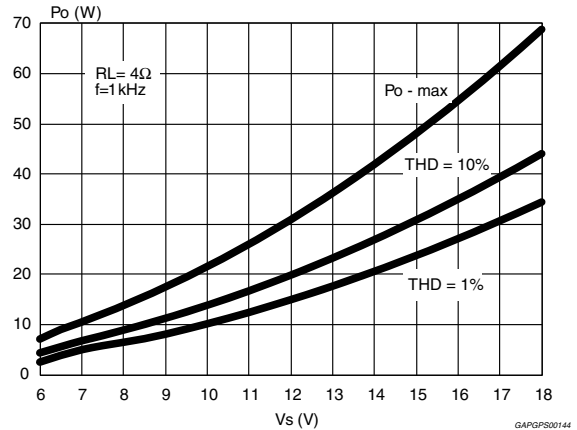

Figure 6. Distortion vs. output power (4 Ω , STD)

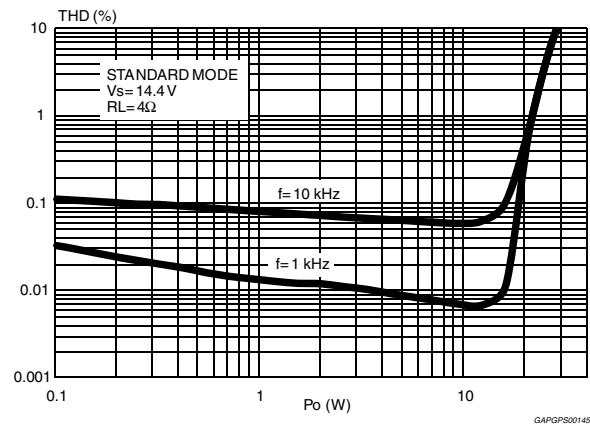

Figure 7. Distortion vs. output power (4 Ω , HI-EFF)

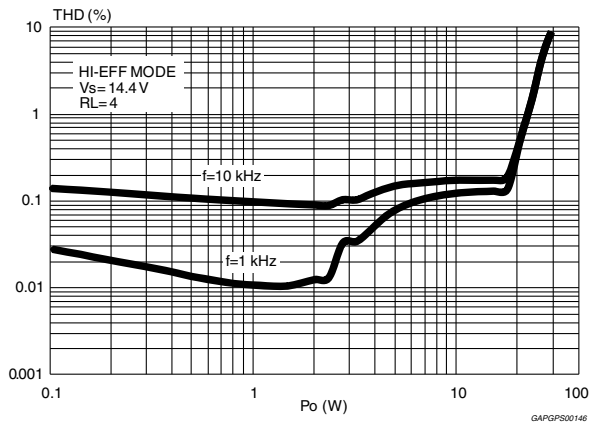

Figure 8. Distortion vs. output power (2 Ω , STD)

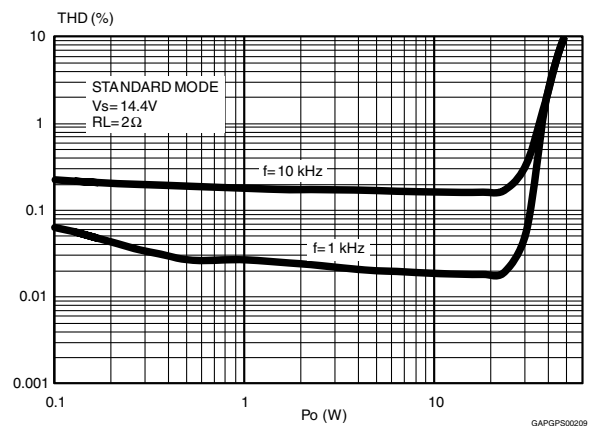

Figure 9. Distortion vs. output power (2 Ω , HI-EFF)

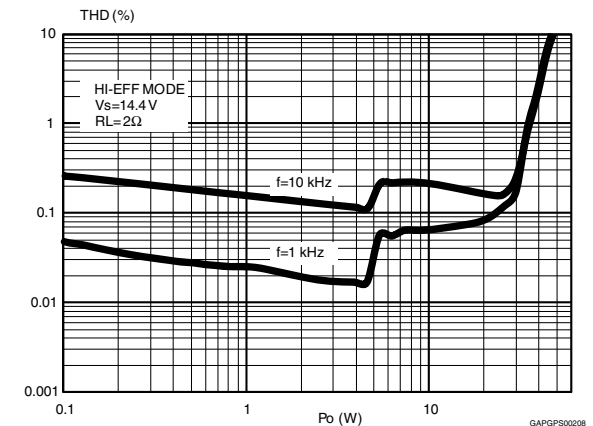

Figure 10. Distortion vs. frequency (2 Ω)

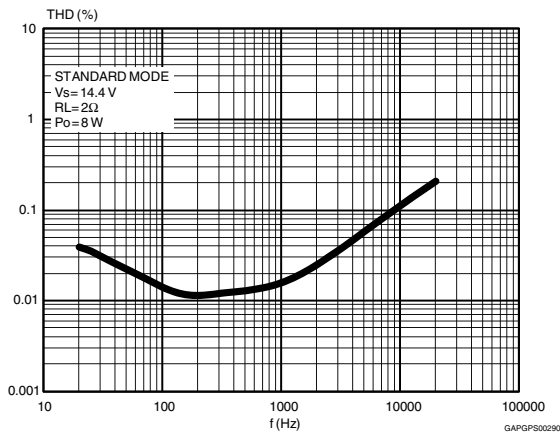

Figure 11. Distortion vs. output power $V_s = 6\text{ V}$ (4 Ω, STD)

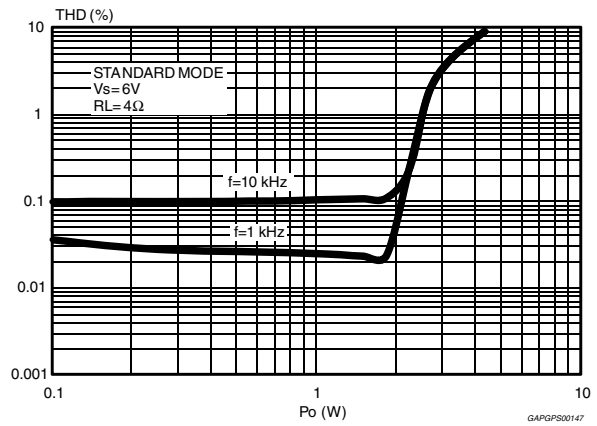

Figure 12. Distortion vs. frequency (4 Ω)

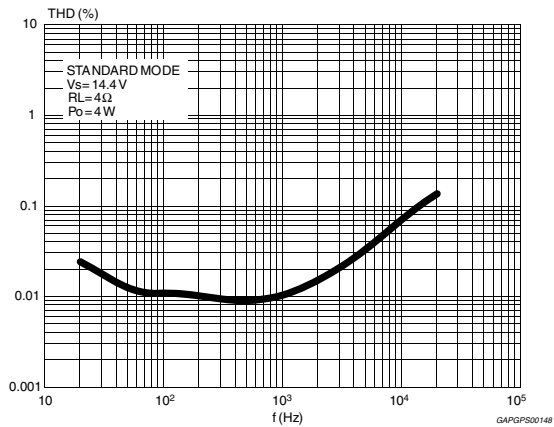

Figure 13. Crosstalk vs. frequency

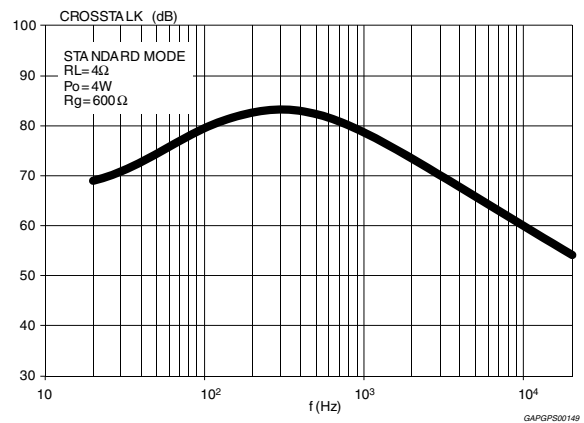

Figure 14. Supply voltage rejection vs. frequency

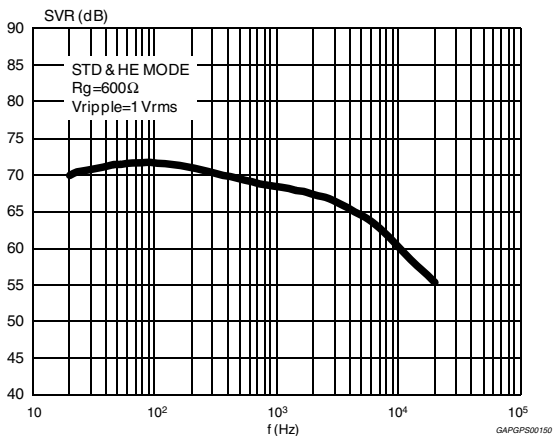

Figure 15. Power dissipation vs. average output power (audio program simulation, 2 Ω)

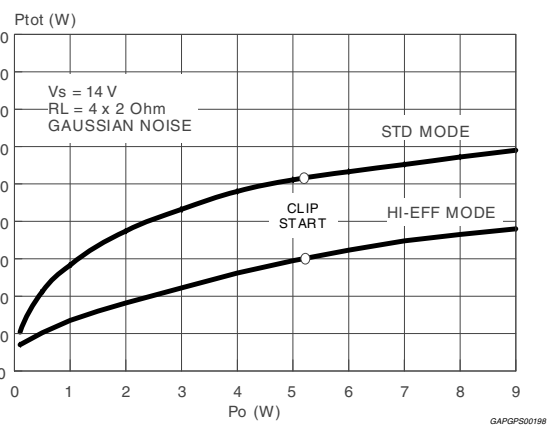

Figure 16. Power dissipation vs. average output power (audio program simulation, 4 Ω)

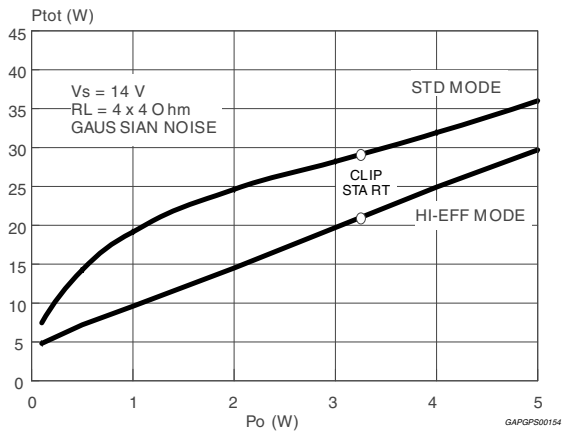

Figure 17. Total power dissipation and efficiency vs. output power (4 Ω, HI-EFF, Sine)

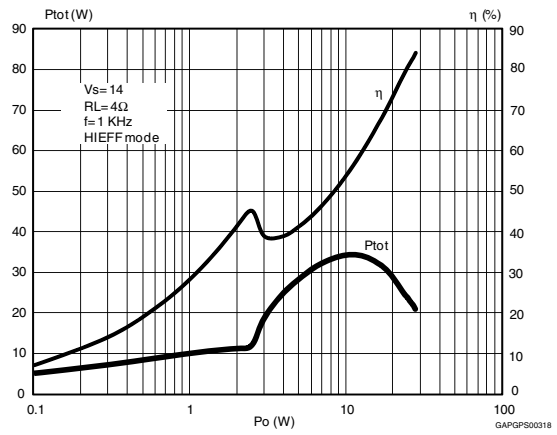

Figure 18. Total power dissipation and efficiency vs. output power (4 Ω, STD, Sine)

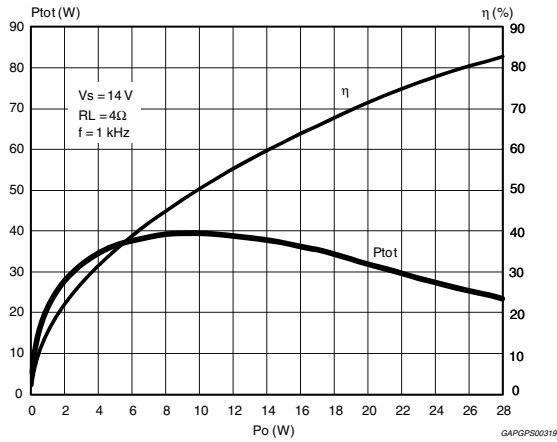
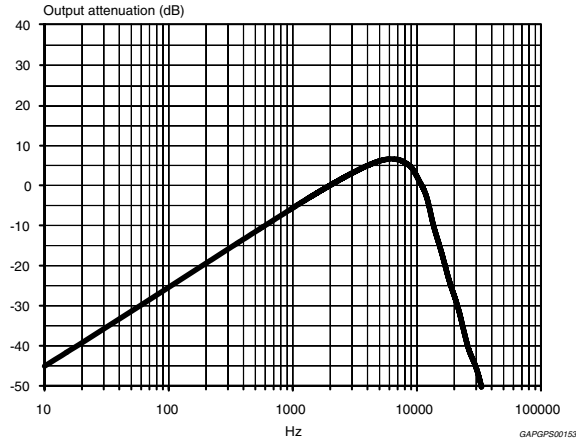

Figure 19. ITU R-ARM frequency response, weighting filter for transient pop



4 Diagnostics functional description

4.1 Turn-on diagnostic

It is strongly recommended to activate this feature at turn-on (standby out) with I²C bus request. Detectable output faults are:

- SHORT TO GND
- SHORT TO V_s
- SHORT ACROSS THE SPEAKER
- OPEN SPEAKER

To verify if any of the above misconnections are in place, a subsonic (inaudible) current pulse (Figure 20) is internally generated, sent through the speaker(s) and sunk back. The Turn On diagnostic status is internally stored until a successive diagnostic pulse is requested (after a I²C reading).

If the "standby out" and "diag. enable" commands are both given through a single programming step, the pulse takes place first (the power stage stays 'off' during the pulses, showing high impedance at the outputs).

Afterwards, when the Amplifier is biased, the PERMANENT diagnostic takes place. The previous turn-on state is kept until a short appears at the outputs.

Figure 20. Turn - on diagnostic: working principle

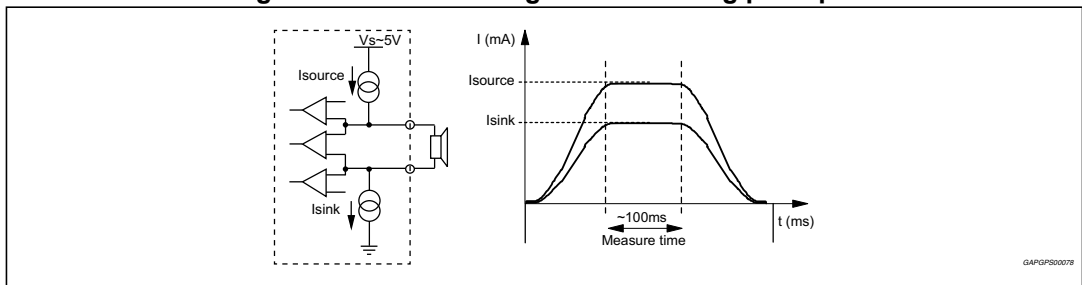

Figure 21 and 22 show SVR and OUTPUT waveforms at the turn-on (standby out) with and without turn-on diagnostic.

Figure 21. SVR and output behavior (Case 1: without turn-on diagnostic)

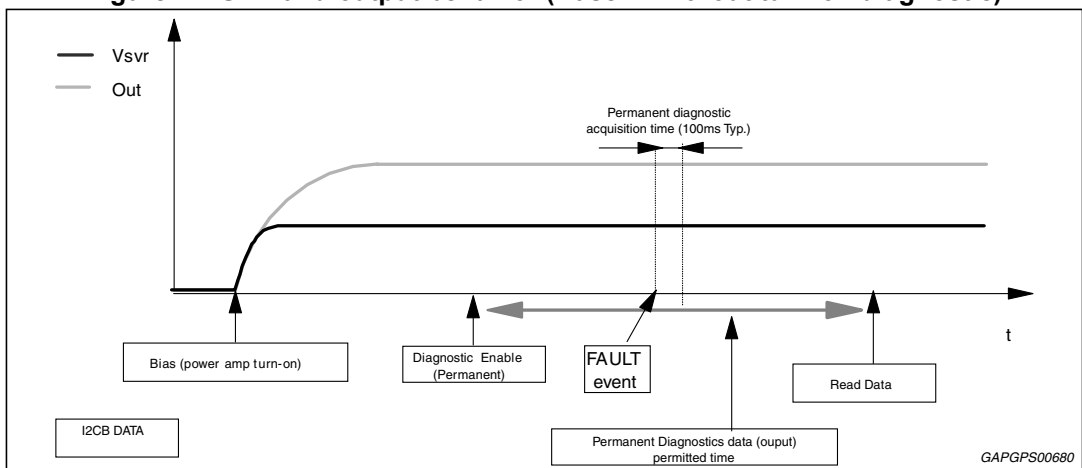
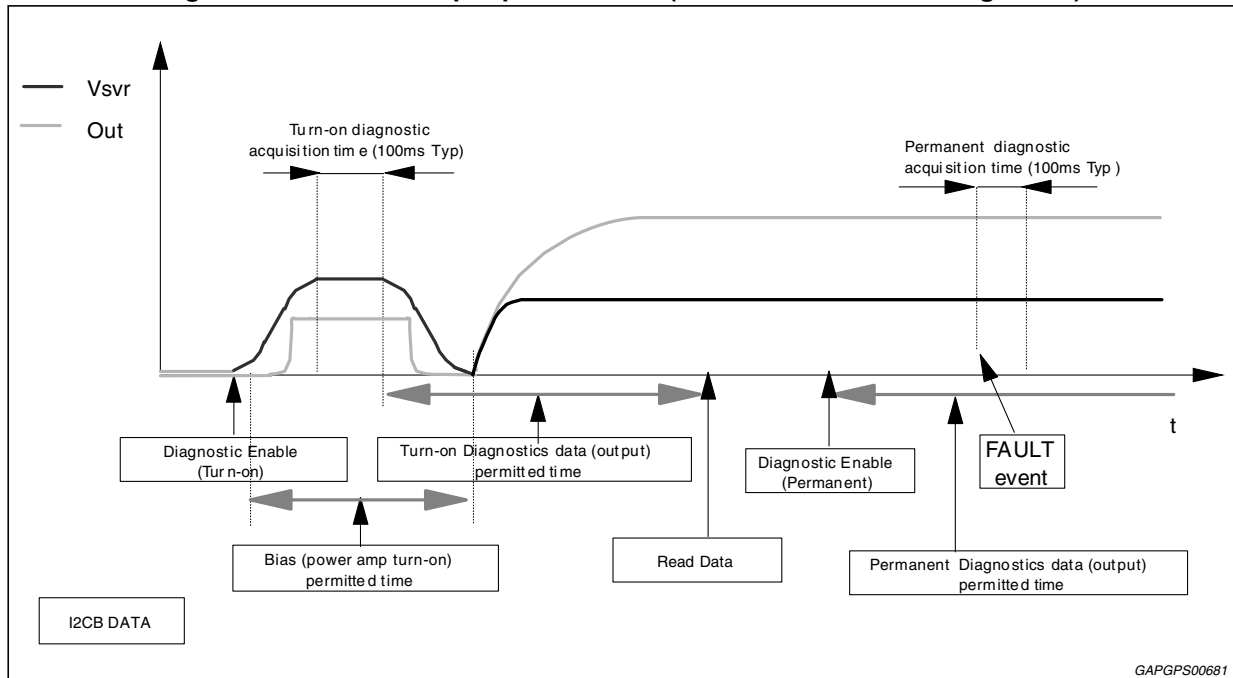
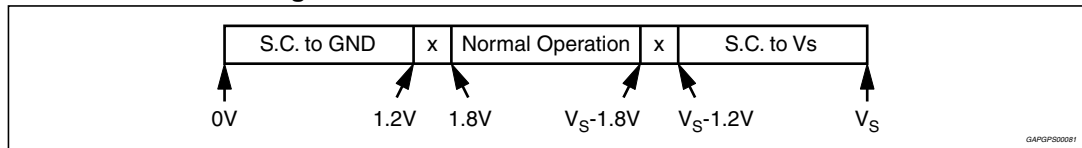

Figure 22. SVR and output pin behavior (Case 2: with turn-on diagnostic)



The information related to the outputs status is read and memorized at the end of the current pulse plateau. The acquisition time is 100 ms (typ.). No audible noise is generated in the process. As for SHORT TO GND / Vs the fault-detection thresholds remain unchanged from 26 dB to 16 dB gain setting. They are as follows:

Figure 23. Short circuit detection thresholds



Concerning SHORT ACROSS THE SPEAKER / OPEN SPEAKER, the threshold varies from 26 dB to 16 dB gain setting, since different loads are expected (either normal speaker's impedance or high impedance). The values in case of 26 dB gain are as follows:

Figure 24. Load detection thresholds - high gain setting

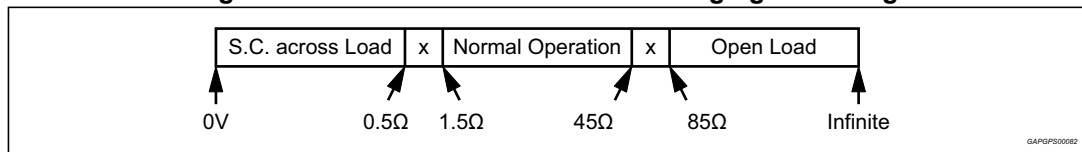

If the Line-Driver mode ($G_v = 16$ dB and Line Driver Mode diagnostic = 1) is selected, the same thresholds will change as follows:

Figure 25. Load detection threshold - low gain setting

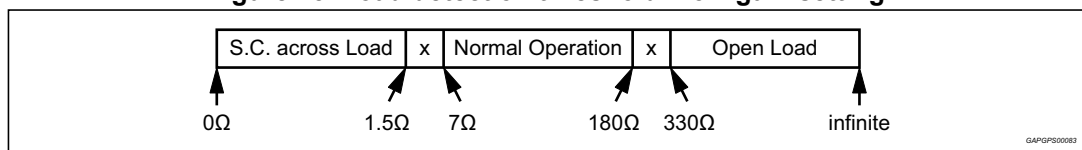

4.2 Permanent diagnostics

Detectable conventional faults are:

- Short to GND
- Short to Vs
- Short across the speaker

The following additional feature is provided:

- Output offset detection

The TDA7569BDLVPD has 2 operating status:

1. **RESTART mode.** The diagnostic is not enabled. Each audio channel operates independently of each other. If any of the a.m. faults occurs, only the channel(s) interested is shut down. A check of the output status is made every 1 ms (*Figure 26*). Restart takes place when the overload is removed.
2. **DIAGNOSTIC mode.** It is enabled via I²C bus and it self activates if an output overload (such as to cause the intervention of the short-circuit protection) occurs to the speakers outputs. Once activated, the diagnostics procedure develops as follows (*Figure 27*):
 - To avoid momentary re-circulation spikes from giving erroneous diagnostics, a check of the output status is made after 1ms: if normal situation (no overloads) is detected, the diagnostic is not performed and the channel returns active.
 - Instead, if an overload is detected during the check after 1 ms, then a diagnostic cycle having a duration of about 100 ms is started.
 - After a diagnostic cycle, the audio channel interested by the fault is switched to RESTART mode. The relevant data are stored inside the device and can be read by the microprocessor. When one cycle has terminated, the next one is activated by an I²C reading. This is to ensure continuous diagnostics throughout the car-radio operating time.
 - To check the status of the device a sampling system is needed. The timing is chosen at microprocessor level (over half a second is recommended).

Figure 26. Restart timing without diagnostic enable (permanent) - Each 1 mS time, a sampling of the fault is done

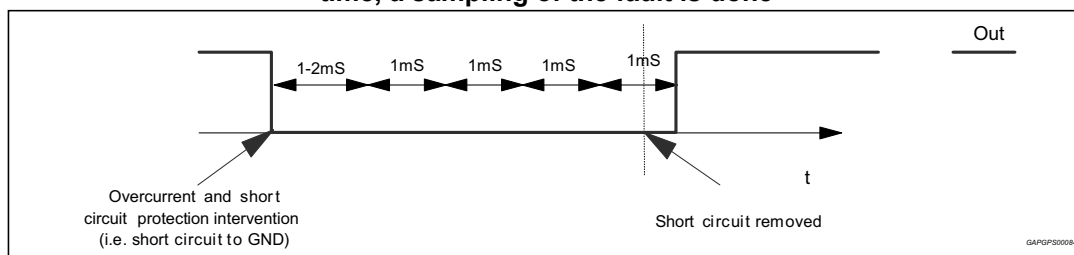
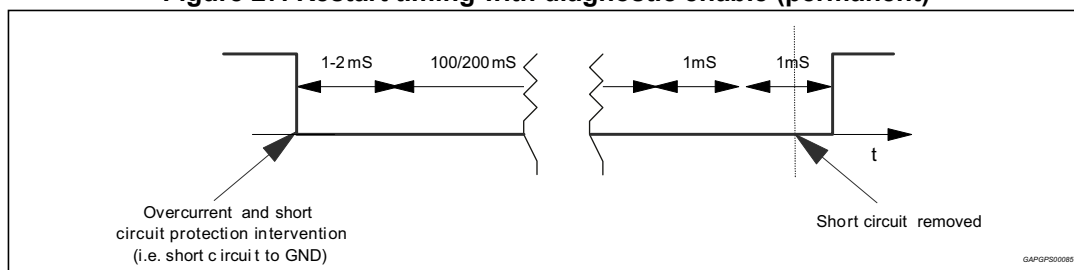

Figure 27. Restart timing with diagnostic enable (permanent)



4.3 Output DC offset detection

Any DC output offset exceeding ± 2 V are signalled out. This inconvenient might occur as a consequence of initially defective or aged and worn-out input capacitors feeding a DC component to the inputs, so putting the speakers at risk of overheating.

This diagnostic has to be performed with low-level output AC signal (or $V_{in} = 0$).

The test is run with selectable time duration by microprocessor (from a "start" to a "stop" command):

- START = Last reading operation or setting IB1 - D5 - (OFFSET enable) to 1
- STOP = Actual reading operation

Excess offset is signalled out if it is persistent for all the assigned testing time. This feature is disabled if any overloads leading to activation of the short-circuit protection occurs in the process.

4.4 AC diagnostic

It is targeted at detecting accidental disconnection of tweeters in 2-way speaker and, more in general, presence of capacitive (AC) coupled loads.

This diagnostic is based on the notion that the overall speaker's impedance (woofer + parallel tweeter) will tend to increase towards high frequencies if the tweeter gets disconnected, because the remaining speaker (woofer) would be out of its operating range (high impedance). The diagnostic decision is made according to peak output current thresholds, and it is enabled by setting (IB2-D2) = 1. Two different detection levels are available:

- High current threshold IB2 (D7) = 0
 $I_{out} > 500$ mApk = normal status
 $I_{out} < 250$ mApk = open tweeter
- Low current threshold IB2 (D7) = 1
 $I_{out} > 250$ mApk = normal status
 $I_{out} < 125$ mApk = open tweeter

To correctly implement this feature, it is necessary to briefly provide a signal tone (with the amplifier in "play") whose frequency and magnitude are such as to produce an output current higher than 500 mApk with IB2(D7) = 0 (higher than 250 mApk with IB2(D7) = 1) in normal conditions and lower than 250 mApk with IB2(D7) = 0 (lower than 125 mApk with IB2(D7) = 1) when the parallel tweeter is missing/disconnected.

The test has to last for a minimum number of 3 sine cycles starting from the activation of the AC diagnostic function IB2<D2> up to the I²C reading of the results (measuring period). To confirm the presence of tweeter, it is necessary to find at least 3 current pulses over the above threshold during the measuring period, else an "open tweeter" message will be issued.

The frequency / magnitude setting of the test tone depends on the impedance characteristics of each specific speaker being used, with or without the tweeter connected (to be calculated case by case). High-frequency tones (> 10 kHz) or even ultrasonic signals are recommended for their negligible acoustic impact and also to maximize the impedance module's ratio between with tweeter-on and tweeter-off.

Figure 28 and 29 shows the load impedance as a function of the peak output voltage and the relevant diagnostic fields.

It is recommended to keep the output voltage always below 8 V (high threshold case) or 4 V (low threshold case), to avoid the circuit to saturate (causing wrong detection cases).

This feature is disabled if any overloads leading to activation of the short-circuit protection occurs in the process.

Figure 28. Current detection high: load impedance |Z| vs. output peak voltage

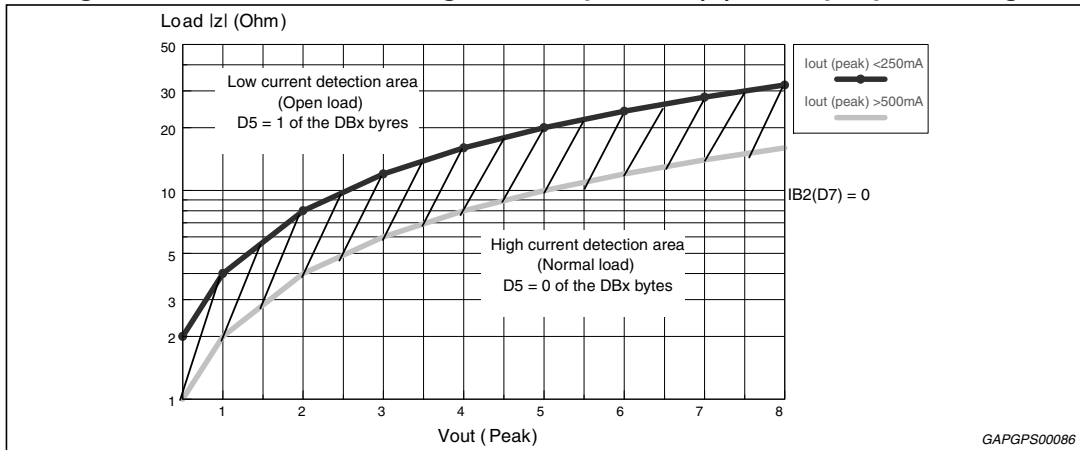
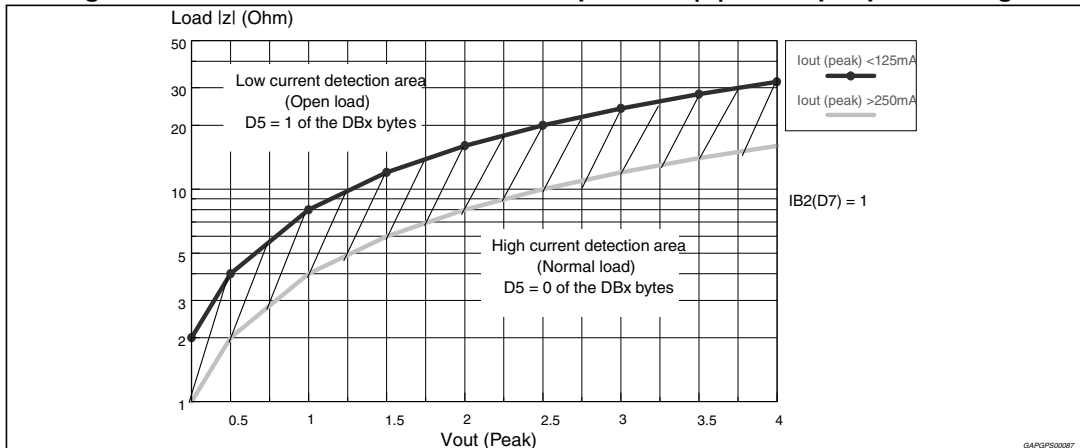

Figure 29. Current detection low: load impedance |Z| vs. output peak voltage



5 Multiple faults

When more misconnections are simultaneously in place at the audio outputs, it is guaranteed that at least one of them is initially read out. The others are notified after successive cycles of I²C reading and faults removal, provided that the diagnostic is enabled. This is true for both kinds of diagnostic (Turn on and Permanent).

The table below shows all the couples of double-fault possible. It should be taken into account that a short circuit with the 4 ohm speaker unconnected is considered as double fault.

Table 6. Double fault table for turn on diagnostic

	S. GND	S. Vs	S. Across L.	Open L.
S. GND	S. GND	S. Vs + S. GND	S. GND	S. GND
S. Vs	/	S. Vs	S. Vs	S. Vs
S. Across L.	/	/	S. Across L.	N.A.
Open L.	/	/	/	Open L. (*)

In Permanent Diagnostic the table is the same, with only a difference concerning Open Load(*), which is not among the recognizable faults. Should an Open Load be present during the device's normal working, it would be detected at a subsequent Turn on Diagnostic cycle (i.e. at the successive Car Radio Turn on).

5.1 Faults availability

All the results coming from I²C bus, by read operations, are the consequence of measurements inside a defined period of time. If the fault is stable throughout the whole period, it will be sent out.

To guarantee always resident functions, every kind of diagnostic cycles (Turn-on, Permanent, Offset) will be reactivate after any I²C reading operation. So, when the micro reads the I²C, a new cycle will be able to start, but the read data will come from the previous diag. cycle (i.e. The device is in Turn-on state, with a short to GND, then the short is removed and micro reads I²C. The short to GND is still present in bytes, because it is the result of the previous cycle. If another I²C reading operation occurs, the bytes do not show the short). In general to observe a change in Diagnostic bytes, two I²C reading operations are necessary.

6 Thermal protection

Thermal protection is implemented through thermal foldback (*Figure 30*).

Thermal foldback begins limiting the audio input to the amplifier stage as the junction temperatures rise above the normal operating range. This effectively limits the output power capability of the device thus reducing the temperature to acceptable levels without totally interrupting the operation of the device.

The output power will decrease to the point at which thermal equilibrium is reached. Thermal equilibrium will be reached when the reduction in output power reduces the dissipated power such that the die temperature falls below the thermal foldback threshold. Should the device cool, the audio level will increase until a new thermal equilibrium is reached or the amplifier reaches full power. Thermal foldback will reduce the audio output level in a linear manner.

Three Thermal warning are available through the I²C bus data. After thermal shut down threshold is reached, the CD could toggle (as shown in *Figure 30*) or stay low, depending on signal level.

Figure 30. Thermal foldback diagram

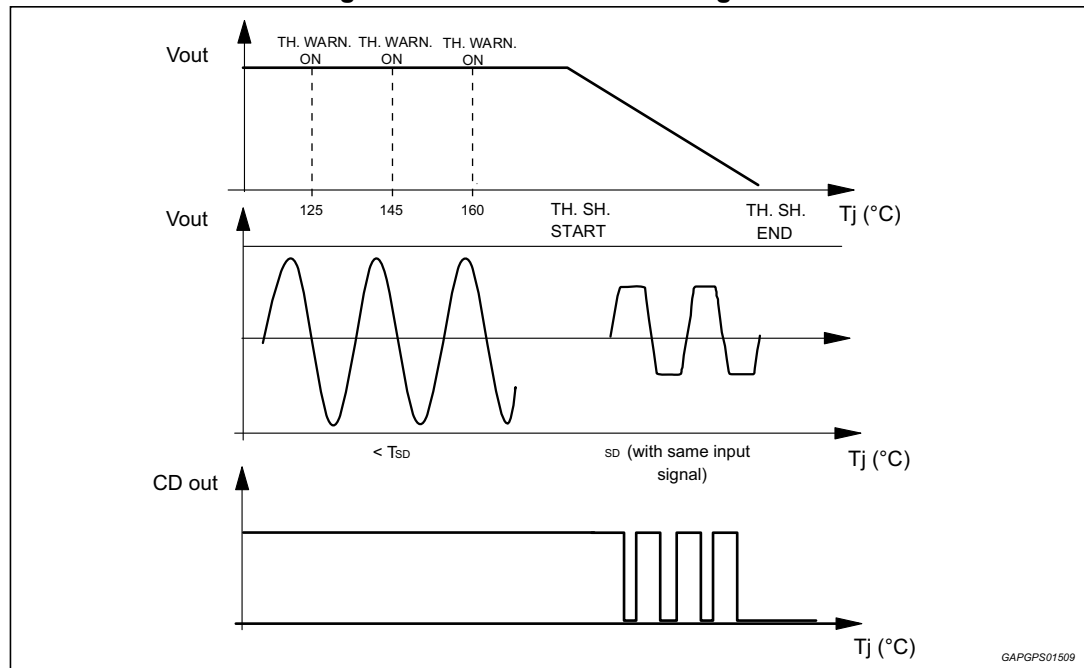

6.1 Fast muting

The muting time can be shortened to less than 1.5ms by setting (IB2) D5 = 1. This option can be useful in transient battery situations (i.e. during car engine cranking) to quickly turnoff the amplifier to avoid any audible effects caused by noise/transients being injected by preamp stages. The bit must be set back to “0” shortly after the mute transition.

7 Battery transition management

7.1 Low voltage (“start stop”) operation

The most recent OEM specifications are requiring automatic stop of car engine at traffic light, in order to reduce emissions of polluting substances. The TDA7569BDLVPD, thanks to its innovating design, is able to play music when battery falls down to 6/7V during such conditions, without producing audible pop noise. The maximum system power will be reduced accordingly.

Worst case battery cranking curves are shown below, indicating the shape and durations of allowed battery transitions

Figure 31. Worst case battery cranking curve sample 1



V1 = 12 V; V2 = 6 V; V3 = 7 V; V4 = 8 V

t1 = 2 ms; t2 = 50 ms; t3 = 5 ms; t4 = 300 ms; t5 = 10 ms; t6 = 1 s; t7 = 2 ms

Figure 32. Worst case battery cranking curve sample 2

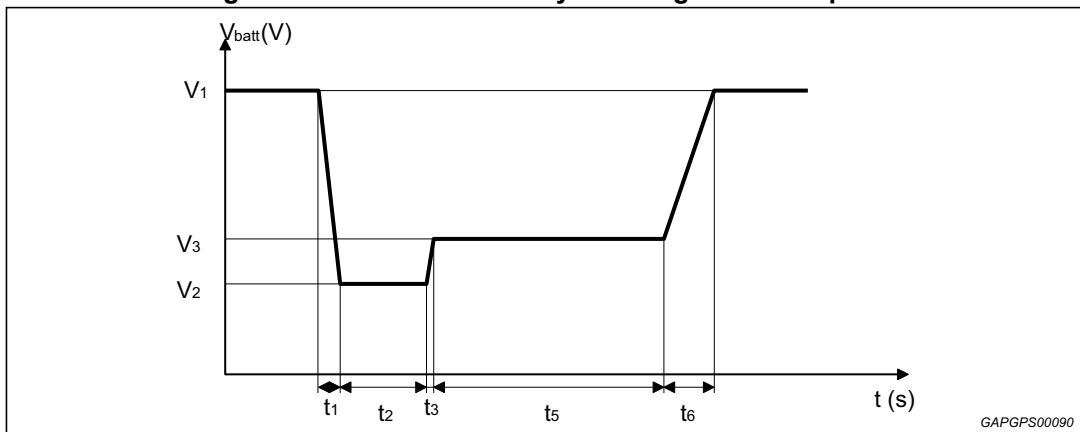

V1 = 12 V; V2 = 6 V; V3 = 7 V

t1 = 2 ms; t2 = 5 ms; t3 = 15 ms; t5 = 1 s; t6 = 50 ms

7.2 Advanced battery management

In addition to compatibility with low V_{batt} , the TDA7569BDLVPD is able to sustain upwards fast battery transitions (like the one showed in *Figure 33*) without causing unwanted audible effect, thanks to the innovative circuit topology.

Figure 33. Upwards fast battery transitions diagram

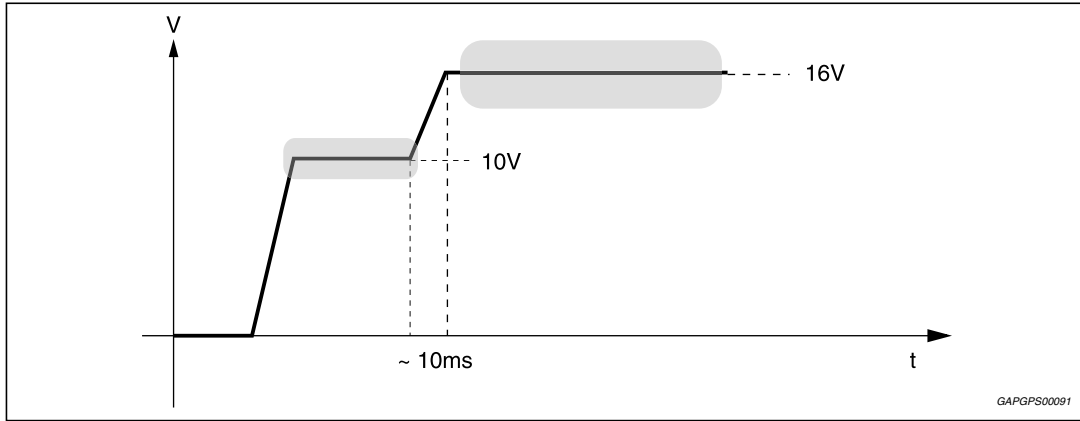

8 Application suggestions

8.1 High efficiency introduction

Thanks to its operating principle, the TDA7569BDLVPD obtains a substantial reduction of power dissipation from traditional class-AB amplifiers without being affected by the massive radiation effects and complex circuitry normally associated with class-D solutions.

The high efficiency operating principle is based on the use of bridge structures which are connected by means of a power switch. In particular, as shown in *Figure 1*, Ch1 is linked to Ch2, while Ch3 to Ch4. The switch, controlled by a logic circuit which senses the input signals, is closed at low volumes (output power steadily lower than 2.5 W) and the system acts like a "single bridge" with double load. In this case, the total power dissipation is a quarter of a double bridge.

Due to its structure, the highest efficiency level can be reached when symmetrical loads are applied on channels sharing the same switch.

Figure 34. High efficiency - basic structure

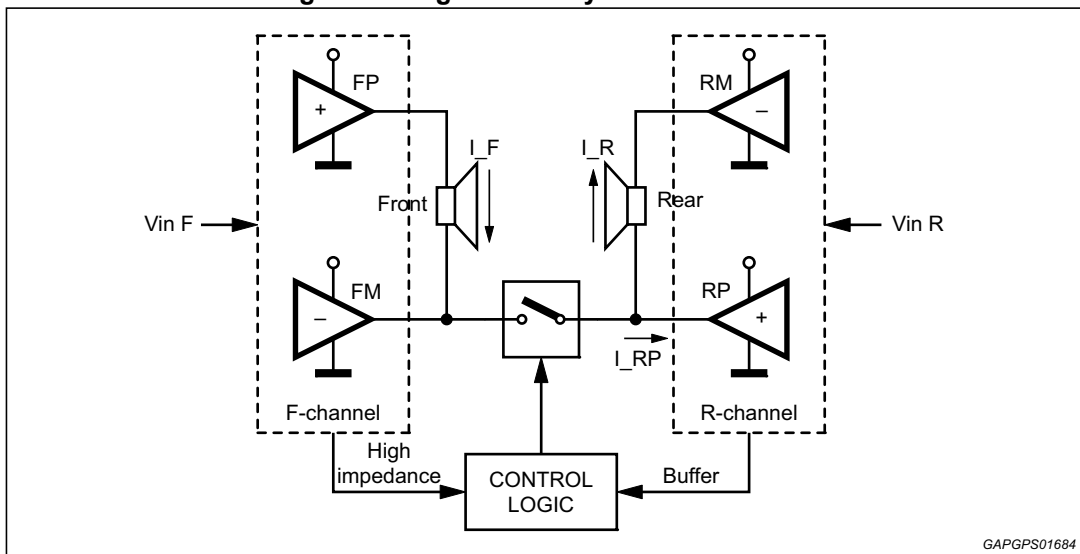

When the power demand increases to more than 2.5 W, the system behavior is switched back to a standard double bridge in order to guarantee the maximum output power, while in the 6 V start-stop devices the High Efficiency mode is automatically disabled at low V_{CC} ($7.3\text{ V} \pm 0.3\text{ V}$). No need to re-program it when V_{CC} goes back to normal levels.

The results show (*Figure 19*) that in the range 2-4 W (@ $V_{CC} = 14.4\text{ V}$, $R_L = 4\ \Omega$), with the High Efficiency mode, the dissipated power gets up to 50 % less than the value obtained with the standard mode.

9 I²C bus

9.1 I²C programming/reading sequences

A correct turn on/off sequence with respect to the diagnostic timings and producing no audible noises could be as follows (after battery connection):

- TURN-ON: PIN2 > 4.5V --- 10ms --- (STAND-BY OUT + DIAG ENABLE) --- 1 s (min) -- - MUTING OUT
- TURN-OFF: MUTING IN - wait for 50 ms - HW ST-BY IN (ST-BY pin \leq 1.2 V)
- Car Radio Installation: PIN2 > 4.5 V --- 10ms DIAG ENABLE (write) --- 200 ms --- I²C read (repeat until All faults disappear).
- OFFSET TEST: Device in Play (no signal) -- OFFSET ENABLE - 30ms - I²C reading (repeat I²C reading until high-offset message disappears).

9.2 Address selection and I²C disable

When the ADSEL/I2CDIS pin is left open the I²C bus is disabled and the device can be controlled by the STBY/MUTE pin.

In this status (no - I²C bus) the CK pin enables the HIGH-EFFICIENCY MODE (0 = STD MODE; 1 = HE MODE) and the DATA pin sets the gain (0 = 26 dB; 1 = 16 dB).

When the ADSEL/I2CDIS pin is connected to GND the I²C bus is active with address <1101100-x>.

To select the other I²C address a resistor must be connected to ADSEL/I2CDIS pin as following:

- $0 < R < 1 \text{ k}\Omega$: I²C bus active with address <1101100x>
- $11 < R < 21 \text{ k}\Omega$: I²C bus active with address <1101101x>
- $40 < R < 70 \text{ k}\Omega$: I²C bus active with address <1101110x>
- $R > 120 \text{ k}\Omega$: Legacy mode

(x: read/write bit sector)

9.3 I²C bus interface

Data transmission from microprocessor to the TDA7569BDLVPD and viceversa takes place through the 2 wires I²C bus interface, consisting of the two lines SDA and SCL (pull-up resistors to positive supply voltage must be connected).

9.3.1 Data validity

As shown by [Figure 35](#), the data on the SDA line must be stable during the high period of the clock. The HIGH and LOW state of the data line can only change when the clock signal on the SCL line is LOW.

9.3.2 Start and stop conditions

As shown by *Figure 36* a start condition is a HIGH to LOW transition of the SDA line while SCL is HIGH. The stop condition is a LOW to HIGH transition of the SDA line while SCL is HIGH.

9.3.3 Byte format

Every byte transferred to the SDA line must contain 8 bits. Each byte must be followed by an acknowledge bit. The MSB is transferred first.

9.3.4 Acknowledge

The transmitter* puts a resistive HIGH level on the SDA line during the acknowledge clock pulse (see *Figure 37*). The receiver** has to pull-down (LOW) the SDA line during the acknowledge clock pulse, so that the SDA line is stable LOW during this clock pulse.

* Transmitter

- master (μ P) when it writes an address to the TDA7569BDLVPD
- slave (TDA7569BDLVPD) when the μ P reads a data byte from TDA7569BDLVPD

** Receiver

- slave (TDA7569BDLVPD) when the μ P writes an address to the TDA7569BDLVPD
- master (μ P) when it reads a data byte from TDA7569BDLVPD

Figure 35. Data validity on the I²C bus

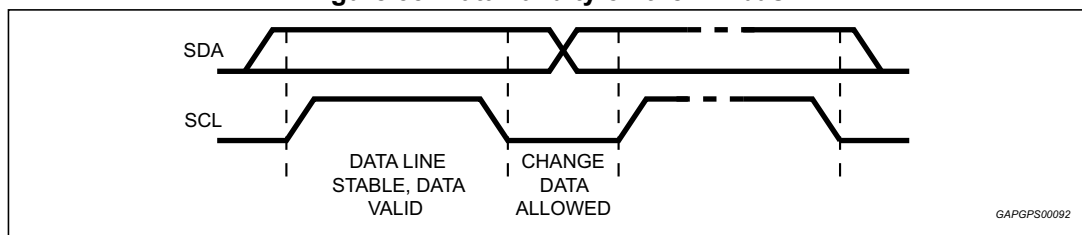

Figure 36. Timing diagram on the I²C bus

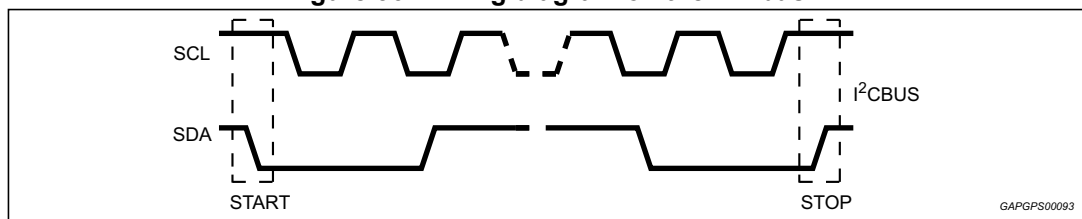
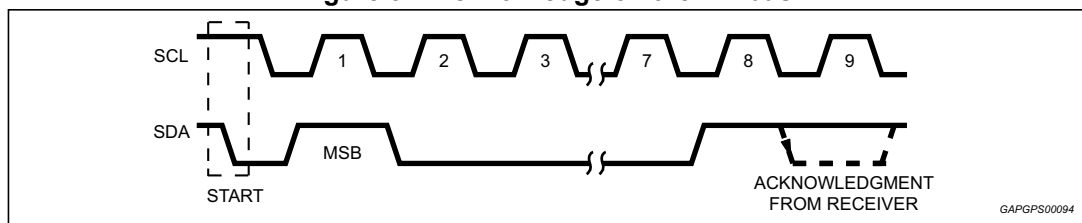

Figure 37. Acknowledge on the I²C bus



10 Software specifications

All the functions of the TDA7569BDLVPD are activated by I²C interface.

The bit 0 of the "ADDRESS BYTE" defines if the next bytes are write instruction (from μP to TDA7569BDLVPD) or read instruction (from TDA7569BDLVPD to μP).

Chip address

D7							D0	
1	1	0	1	1	(*)	(*)	X	D8 Hex

X = 0 Write to device

X = 1 Read from device

If R/W = 0, the μP sends 2 "Instruction Bytes": IB1 and IB2.

(*) address selector bit, please refer to address selection description on [Section 9.2](#).

Table 7. IB1

Bit	Instruction decoding bit
D7	Supply transition mute threshold high (D7 = 1) (8 V) Supply transition mute threshold low (D7 = 0) (6 V)
D6	Diagnostic enable (D6 = 1) Diagnostic defeat (D6 = 0)
D5	Offset Detection enable (D5 = 1) Offset Detection defeat (D5 = 0)
D4	Front Channel Gain = 26 dB (D4 = 0) Gain = 16 dB (D4 = 1)
D3	Rear Channel Gain = 26 dB (D3 = 0) Gain = 16 dB (D3 = 1)
D2	Mute front channels (D2 = 0) Unmute front channels (D2 = 1)
D1	Mute rear channels (D1 = 0) Unmute rear channels (D1 = 1)
D0	CD 2% (D0 = 0) CD 10% (D0 = 1)

Table 8. IB2

Bit	Instruction decoding bit
D7	Current detection threshold High th (D7 = 0) Low th (D7 =1)
D6	0
D5	Normal muting time (D5 = 0) Fast muting time (D5 = 1)
D4	Stand-by on - Amplifier not working - (D4 = 0) Stand-by off - Amplifier working - (D4 = 1)
D3	Power amplifier mode diagnostic (D3 = 0) Line driver mode diagnostic (D3 = 1)
D2	Current Detection Diagnostic Enabled (D2 =1) Current Detection Diagnostic Defeat (D2 =0)
D1	Right Channel Power amplifier working in standard mode (D1 = 0) Power amplifier working in high efficiency mode (D1 = 1)
D0	Left Channel Power amplifier working in standard mode (D0 = 0) Power amplifier working in high efficiency mode (D0 = 1)

If R/W = 1, the TDA7569BDLVPD sends 4 "Diagnostics Bytes" to μ P: DB1, DB2, DB3 and DB4.

Table 9. DB1

Bit	Instruction decoding bit	
D7	Thermal warning 1 active (D7 = 1), $T_j = 160^\circ\text{C}$ -	
D6	Diag. cycle not activated or not terminated (D6 = 0) Diag. cycle terminated (D6 = 1) -	
D5	Channel LF (CH1) Current detection IB2 (D7) = 0 Output peak current < 250 mA - Open load (D5 = 1) Output peak current > 500 mA - Normal load (D5 = 0)	Channel LF (CH1) Current detection IB2 (D7) = 1 Output peak current < 125 mA - Open load (D5 = 1) Output peak current > 250 mA - Normal load (D5 = 0)
D4	Channel LF (CH1) Turn-on diagnostic (D4 = 0) Permanent diagnostic (D4 = 1) -	
D3	Channel LF (CH1) Normal load (D3 = 0) Short load (D3 = 1) -	
D2	Channel LF (CH1) Turn-on diag.: No open load (D2 = 0) Open load detection (D2 = 1) Offset diag.: No output offset (D2 = 0) Output offset detection (D2 = 1) -	

Table 9. DB1 (continued)

Bit	Instruction decoding bit	
D1	Channel LF (CH1) No short to Vcc (D1 = 0) Short to Vcc (D1 = 1)	-
D0	Channel LF (CH1) No short to GND (D1 = 0) Short to GND (D1 = 1)	-

Table 10. DB2

Bit	Instruction decoding bit	
D7	Offset detection not activated (D7 = 0) Offset detection activated (D7 = 1)	-
D6	X	-
D5	Channel LR (CH2) Current detection IB2 (D7) = 0 Output peak current < 250 mA - Open load (D5 = 1) Output peak current > 500 mA - Normal load (D5 = 0)	Channel LR (CH2) Current detection IB2 (D7) = 1 Output peak current < 125 mA - Open load (D5 = 1) Output peak current > 250 mA - Normal load (D5 = 0)
D4	Channel LR (CH2) Turn-on diagnostic (D4 = 0) Permanent diagnostic (D4 = 1)	-
D3	Channel LR (CH2) Normal load (D3 = 0) Short load (D3 = 1)	-
D2	Channel LR (CH2) Turn-on diag.: No open load (D2 = 0) Open load detection (D2 = 1) Permanent diag.: No output offset (D2 = 0) Output offset detection (D2 = 1)	-
D1	Channel LR (CH2) No short to Vcc (D1 = 0) Short to Vcc (D1 = 1)	-
D0	Channel LR (CH2) No short to GND (D1 = 0) Short to GND (D1 = 1)	-

Table 11. DB3

Bit	Instruction decoding bit	
D7	Standby status (= IB2 - D4)	-
D6	Diagnostic status (= IB1 - D6)	-
D5	Channel RF (CH3) Current detection IB2 (D7) = 0 Output peak current < 250 mA - Open load (D5 = 1) Output peak current > 500 mA - Normal load (D5 = 0)	Channel RF (CH3) Current detection IB2 (D7) = 1 Output peak current < 125 mA - Open load (D5 = 1) Output peak current > 250 mA - Normal load (D5 = 0)
D4	Channel RF (CH3) Turn-on diagnostic (D4 = 0) Permanent diagnostic (D4 = 1)	-
D3	Channel RF (CH3) Normal load (D3 = 0) Short load (D3 = 1)	-
D2	Channel RF (CH3) Turn-on diag.: No open load (D2 = 0) Open load detection (D2 = 1) Permanent diag.: No output offset (D2 = 0) Output offset detection (D2 = 1)	-
D1	Channel RF (CH3) No short to Vcc (D1 = 0) Short to Vcc (D1 = 1)	-
D0	Channel RF (CH3) No short to GND (D1 = 0) Short to GND (D1 = 1)	-

Table 12. DB4

Bit	Instruction decoding bit	
D7	Thermal warning 2 active (D7 = 1), T _j = 145°C	-
D6	Thermal warning 3 active (D6 = 1) T _j = 125°C	-
D5	Channel RR (CH4) Current detection IB2 (D7) = 0 Output peak current < 250 mA - Open load (D5 = 1) Output peak current > 500 mA - Normal load (D5 = 0)	Channel RR (CH4) Current detection IB2 (D7) = 1 Output peak current < 125 mA - Open load (D5 = 1) Output peak current > 250 mA - Normal load (D5 = 0)
D4	Channel RR (CH4) Turn-on diagnostic (D4 = 0) Permanent diagnostic (D4 = 1)	-
D3	Channel R (CH4) R Normal load (D3 = 0) Short load (D3 = 1)	-
D2	Channel RR (CH4) Turn-on diag.: No open load (D2 = 0) Open load detection (D2 = 1) Permanent diag.: No output offset (D2 = 0) Output offset detection (D2 = 1)	-
D1	Channel RR (CH4) No short to Vcc (D1 = 0) Short to Vcc (D1 = 1)	-
D0	Channel RR (CH4) No short to GND (D1 = 0) Short to GND (D1 = 1)	-

11 Examples of bytes sequence

1 - Turn-On diagnostic - Write operation

Start	Address byte with D0 = 0	ACK	IB1 with D6 = 1	ACK	IB2	ACK	STOP
-------	--------------------------	-----	-----------------	-----	-----	-----	------

2 - Turn-On diagnostic - Read operation

Start	Address byte with D0 = 1	ACK	DB1	ACK	DB2	ACK	DB3	ACK	DB4	ACK	STOP
-------	--------------------------	-----	-----	-----	-----	-----	-----	-----	-----	-----	------

The delay from 1 to 2 can be selected by software, starting from 1ms

3a - Turn-On of the power amplifier with 26 dB gain, mute on, diagnostic defeat, CD = 2%

Start	Address byte with D0 = 0	ACK	IB1	ACK	IB2	ACK	STOP
			X0000000		XXX1XX11		

3b - Turn-Off of the power amplifier

Start	Address byte with D0 = 0	ACK	IB1	ACK	IB2	ACK	STOP
			X0XXXXXX		XXX0XXXX		

4 - Offset detection procedure enable

Start	Address byte with D0 = 0	ACK	IB1	ACK	IB2	ACK	STOP
			XX1XX11X		XXX1XXXX		

5 - Offset detection procedure stop and reading operation (the results are valid only for the offset detection bits (D2 of the bytes DB1, DB2, DB3, DB4)

Start	Address byte with D0 = 1	ACK	DB1	ACK	DB2	ACK	DB3	ACK	DB4	ACK	STOP
-------	--------------------------	-----	-----	-----	-----	-----	-----	-----	-----	-----	------

- The purpose of this test is to check if a D.C. offset (2V typ.) is present on the outputs, produced by input capacitor with anomalous leakage current or humidity between pins.
- The delay from 4 to 5 can be selected by software, starting from 1ms

12 Package information

In order to meet environmental requirements, ST offers these devices in different grades of ECOPACK® packages, depending on their level of environmental compliance. ECOPACK® specifications, grade definitions and product status are available at: www.st.com.

ECOPACK® is an ST trademark.

Figure 38. PowerSO36 (slug up) mechanical data and package dimensions

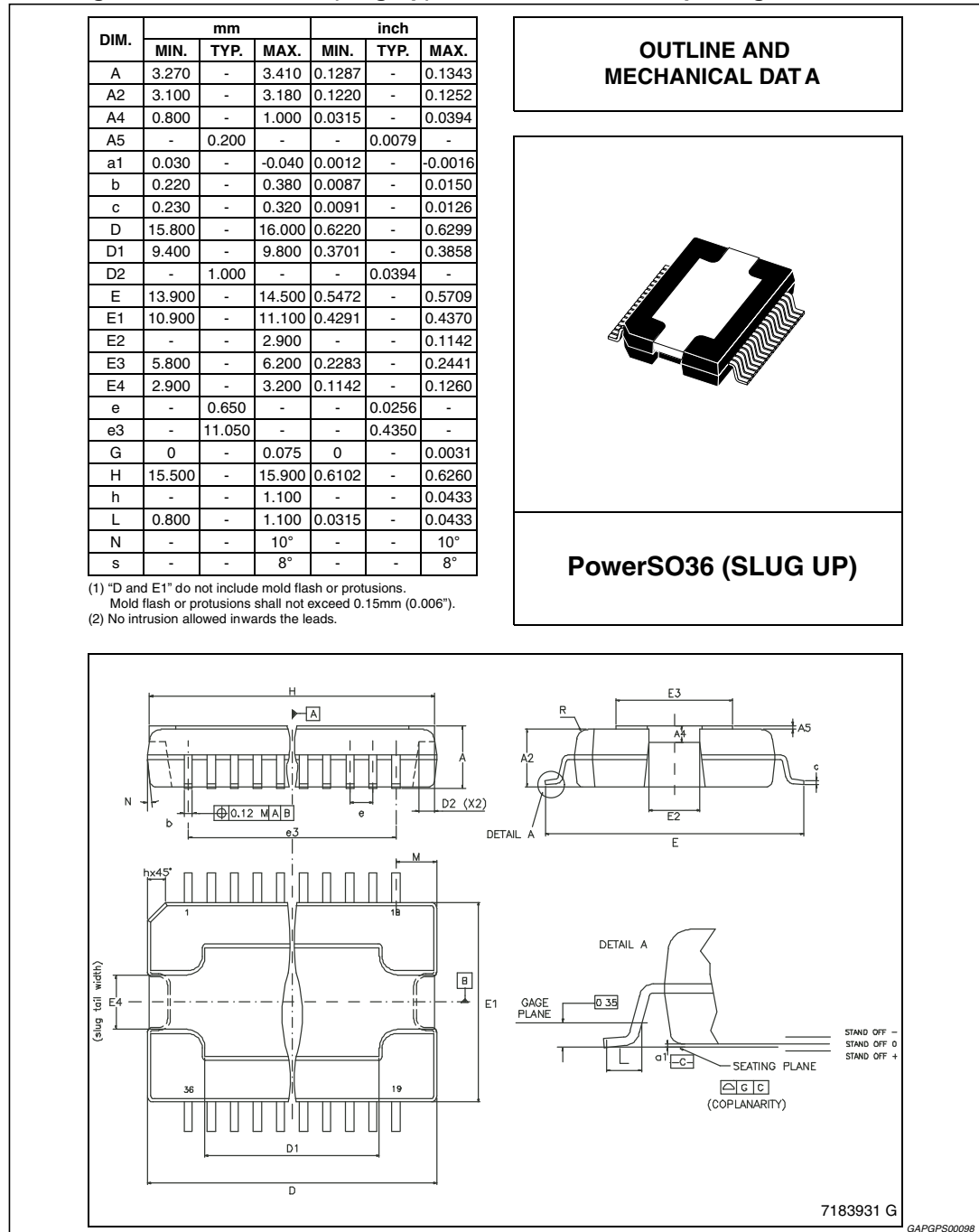

13 Revision history

Table 13. Document revision history

Date	Revision	Changes
18-Jan-2013	1	Initial release.
25-Jan-2013	2	Updated Section 8.1: High efficiency introduction on page 26 .
18-Sep-2013	3	Updated Disclaimer.
04-Oct-2013	4	Updated Table 5: Electrical characteristics . Updated Section 9.3.4: Acknowledge on page 28 .
12-Mar-2014	5	Updated Figure 2 note (*); Table 5: Electrical characteristics (ΔV_{OITU} parameter on page 11).
18-Sep-2014	6	Updated Section 9.1: I²C programming/reading sequences on page 27 .

IMPORTANT NOTICE – PLEASE READ CAREFULLY

STMicroelectronics NV and its subsidiaries (“ST”) reserve the right to make changes, corrections, enhancements, modifications, and improvements to ST products and/or to this document at any time without notice. Purchasers should obtain the latest relevant information on ST products before placing orders. ST products are sold pursuant to ST’s terms and conditions of sale in place at the time of order acknowledgement.

Purchasers are solely responsible for the choice, selection, and use of ST products and ST assumes no liability for application assistance or the design of Purchasers’ products.

No license, express or implied, to any intellectual property right is granted by ST herein.

Resale of ST products with provisions different from the information set forth herein shall void any warranty granted by ST for such product.

ST and the ST logo are trademarks of ST. All other product or service names are the property of their respective owners.

Information in this document supersedes and replaces information previously supplied in any prior versions of this document.

© 2014 STMicroelectronics – All rights reserved





Стандарт Электрон Связь

Мы молодая и активно развивающаяся компания в области поставок электронных компонентов. Мы поставляем электронные компоненты отечественного и импортного производства напрямую от производителей и с крупнейших складов мира.

Благодаря сотрудничеству с мировыми поставщиками мы осуществляем комплексные и плановые поставки широчайшего спектра электронных компонентов.

Собственная эффективная логистика и склад в обеспечивает надежную поставку продукции в точно указанные сроки по всей России.

Мы осуществляем техническую поддержку нашим клиентам и предпродажную проверку качества продукции. На все поставляемые продукты мы предоставляем гарантию .

Осуществляем поставки продукции под контролем ВП МО РФ на предприятия военно-промышленного комплекса России , а также работаем в рамках 275 ФЗ с открытием отдельных счетов в уполномоченном банке. Система менеджмента качества компании соответствует требованиям ГОСТ ISO 9001.

Минимальные сроки поставки, гибкие цены, неограниченный ассортимент и индивидуальный подход к клиентам являются основой для выстраивания долгосрочного и эффективного сотрудничества с предприятиями радиоэлектронной промышленности, предприятиями ВПК и научно-исследовательскими институтами России.

С нами вы становитесь еще успешнее!

Наши контакты:

Телефон: +7 812 627 14 35

Электронная почта: sales@st-electron.ru

Адрес: 198099, Санкт-Петербург,
Промышленная ул, дом № 19, литера Н,
помещение 100-Н Офис 331