

Optocoupler, Phototriac Output, Zero Crossing, High dV/dt, Low Input Current

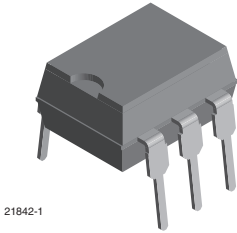

21842-1

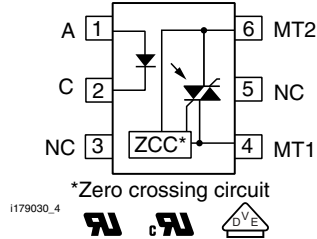

FEATURES

- High static dV/dt 5 kV/ μ s
- High input sensitivity $I_{FT} = 1.6$ mA, 2 mA, and 3 mA
- 300 mA on-state current
- Zero voltage crossing detector
- 400 V and 600 V blocking voltage
- Isolation test voltage 5300 V_{RMS}
- Compliant to RoHS Directive 2011/65/EU

RoHS
 COMPLIANT

DESCRIPTION

The VO4154 and VO4156 consists of a GaAs IRLED optically coupled to a photosensitive zero crossing TRIAC packaged in a DIP-6 package.

High input sensitivity is achieved by using an emitter follower phototransistor and a cascaded SCR predriver resulting in an LED trigger current of 1.6 mA for bin D, 2 mA for bin H, and 3 mA for bin M.

The new phototriac zero crossing family uses a proprietary dV/dt clamp resulting in a static dV/dt of greater than 5 kV/ μ s.

The VO4154 and VO4156 isolates low-voltage logic from 120 V_{AC}, 240 V_{AC}, and 380 V_{AC} lines to control resistive, inductive, or capacitive loads including motors, solenoids, high current thyristors or TRIAC and relays.

APPLICATIONS

- Solid-state relays
- Industrial controls
- Office equipment
- Consumer appliances

AGENCY APPROVALS

- UL1577, file no. E52744 system code H or J, double protection
- cUL - file no. E52744, equivalent to CSA bulletin 5A
- DIN EN 60747-5-2 (VDE 0884) available with option 1

ORDERING INFORMATION						
<div style="display: flex; justify-content: space-around; border: 1px solid black; padding: 2px;"> VO415#X-X00#T </div>						
PART NUMBER			PACKAGE OPTION		TAPE AND REEL	
AGENCY CERTIFIED/PACKAGE	V _{DRM} 400			V _{DRM} 600		
	TRIGGER CURRENT, I _{FT} (mA)					
UL, cUL	1.6	2	3	1.6	2	3
DIP-6	VO4154D	VO4154H	VO4154M	VO4156D	VO4156H	VO4156M
DIP-6, 400 mil, option 6	VO4154D-X006	VO4154H-X006	VO4154M-X006	VO4156D-X006	VO4156H-X006	VO4156M-X006
SMD-6, option 7	VO4154D-X007T	VO4154H-X007T	VO4154M-X007T	VO4156D-X007T	VO4156H-X007T	VO4156M-X007T



ABSOLUTE MAXIMUM RATINGS ($T_{amb} = 25\text{ }^{\circ}\text{C}$, unless otherwise specified)					
PARAMETER	TEST CONDITION	PART	SYMBOL	VALUE	UNIT
INPUT					
Reverse voltage			V_R	6	V
Forward current			I_F	60	mA
Surge current			I_{FSM}	2.5	A
Power dissipation			P_{diss}	100	mW
Derate from 25 °C				1.33	mW/°C
OUTPUT					
Peak off-state voltage		VO4154D/H/M	V_{DRM}	400	V
		VO4156D/H/M	V_{DRM}	600	V
RMS on-state current			I_{TM}	300	mA
Total power dissipation			P_{diss}	500	mW
Derate from 25 °C				6.6	mW/°C
COUPLER					
Isolation test voltage (between emitter and detector, climate per DIN 500414, part 2, Nov. 74)	$t = 1\text{ min}$		V_{ISO}	5300	V_{RMS}
Storage temperature range			T_{stg}	- 55 to + 150	°C
Ambient temperature range			T_{amb}	- 55 to + 100	°C
Soldering temperature	max. $\leq 10\text{ s}$ dip soldering $\geq 0.5\text{ mm}$ from case bottom		T_{sld}	260	°C

Note

- Stresses in excess of the absolute maximum ratings can cause permanent damage to the device. Functional operation of the device is not implied at these or any other conditions in excess of those given in the operational sections of this document. Exposure to absolute maximum ratings for extended periods of the time can adversely affect reliability.

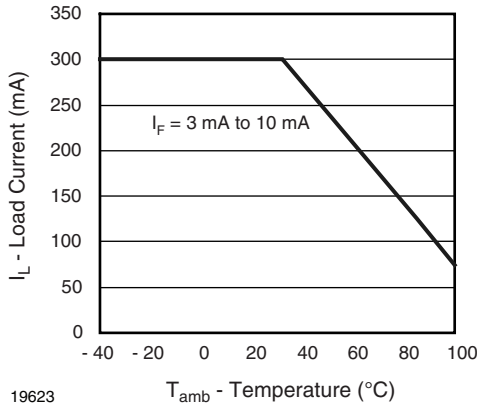

Fig. 1 - Recommended Operating Condition

THERMAL CHARACTERISTICS				
PARAMETER	SYMBOL	VALUE	UNIT	
LED power dissipation	P_{diss}	100	mW	
Output power dissipation	P_{diss}	500	mW	
Maximum LED junction temperature	$T_{jmax.}$	125	°C	
Maximum output die junction temperature	$T_{jmax.}$	125	°C	
Thermal resistance, junction emitter to board	θ_{JEB}	150	°C/W	
Thermal resistance, junction emitter to case	θ_{JEC}	139	°C/W	
Thermal resistance, junction detector to board	θ_{JDB}	78	°C/W	
Thermal resistance, junction detector to case	θ_{JDC}	103	°C/W	
Thermal resistance, junction emitter to junction detector	θ_{JED}	496	°C/W	
Thermal resistance, case to ambient	θ_{CA}	3563	°C/W	

Note

- The thermal characteristics table above were measured at 25 °C and the thermal model is represented in the thermal network below. Each resistance value given in this model can be used to calculate the temperatures at each node for a given operating condition. The thermal resistance from board to ambient will be dependent on the type of PCB, layout and thickness of copper traces. For a detailed explanation of the thermal model, please reference Vishay's Thermal Characteristics of Optocouplers application note.

ELECTRICAL CHARACTERISTICS ($T_{amb} = 25\text{ °C}$, unless otherwise specified)							
PARAMETER	TEST CONDITION	PART	SYMBOL	MIN.	TYP.	MAX.	UNIT
INPUT							
Forward voltage	$I_F = 10\text{ mA}$		V_F		1.2	1.4	V
Reverse current	$V_R = 6\text{ V}$		I_R		0.1	10	μA
Input capacitance	$V_F = 0\text{ V}$, $f = 1\text{ MHz}$		C_I		25		pF
OUTPUT							
Repetitive peak off-state voltage	$I_{DRM} = 100\text{ μA}$	VO4154D/H/M	V_{DRM}	400			V
		VO4156D/H/M	V_{DRM}	600			V
Off-state current	$V_D = V_{DRM}$, $I_F = 0\text{ A}$		I_{DRM}			100	μA
On-state voltage	$I_T = 300\text{ mA}$		V_{TM}			3	V
On-state current	$PF = 1$, $V_{T(RMS)} = 1.7\text{ V}$		I_{TM}			300	mA
Off-state current in inhibit state	$I_F = 2\text{ mA}$, V_{DRM}		I_{DINH}			200	μA
Holding current			I_H			500	μA
Zero cross inhibit voltage	$I_F = \text{rated } I_{FT}$		V_{IH}			20	V
Critical rate of rise of off-state voltage	$V_D = 0.67 V_{DRM}$, $T_J = 25\text{ °C}$		dV/dt_{cr}	5000			V/μs
Critical rate of rise of on-state			dV/dt_{cr}	8			A/μs
COUPLER							
LED trigger current, current required to latch output	$V_D = 3\text{ V}$	VO4154D	I_{FT}			1.6	mA
		VO4154H	I_{FT}			2	mA
		VO4154M	I_{FT}			3	mA
		VO4156D	I_{FT}			1.6	mA
		VO4156H	I_{FT}			2	mA
		VO4156M	I_{FT}			3	mA
Common mode coupling capacitance			C_{CM}		0.01		pF
Capacitance (input to output)	$f = 1\text{ MHz}$, $V_{IO} = 0\text{ V}$		C_{IO}		0.8		pF

Note

- Minimum and maximum values were tested requirements. Typical values are characteristics of the device and are the result of engineering evaluations. Typical values are for information only and are not part of the testing requirements.



SAFETY AND INSULATION RATINGS						
PARAMETER	TEST CONDITION	SYMBOL	MIN.	TYP.	MAX.	UNIT
Climatic classification (according to IEC68 part 1)				55/100/21		
Pollution degree (DIN VDE 0109)				2		
Comparative tracking index per DIN IEC112/VDE 0303 part 1, group IIIa per DIN VDE 6110 175 399			175		399	
V_{IOTM}		V_{IOTM}	8000			V
V_{IORM}		V_{IORM}	890			V
P_{SO}		P_{SO}			500	mW
I_{SI}		I_{SI}			250	mA
T_{SI}		T_{SI}			175	°C
Creepage distance			7			mm
Clearance distance			7			mm

TYPICAL CHARACTERISTICS ($T_{amb} = 25\text{ °C}$, unless otherwise specified)

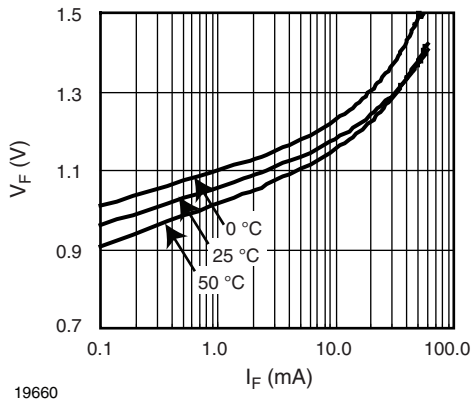

Fig. 2 - Diode Forward Voltage vs. Forward Current

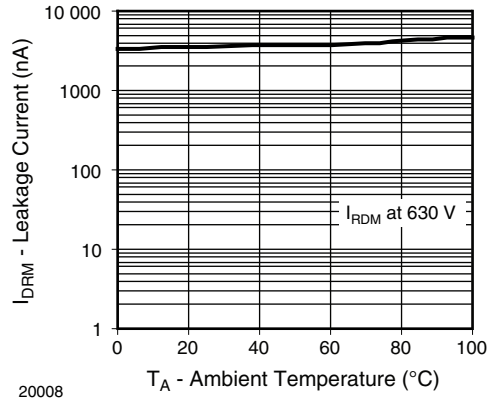

Fig. 4 - Leakage Current vs. Ambient Temperature

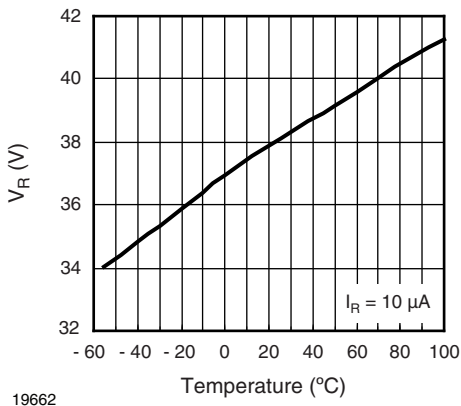

Fig. 3 - Diode Reverse Voltage vs. Temperature

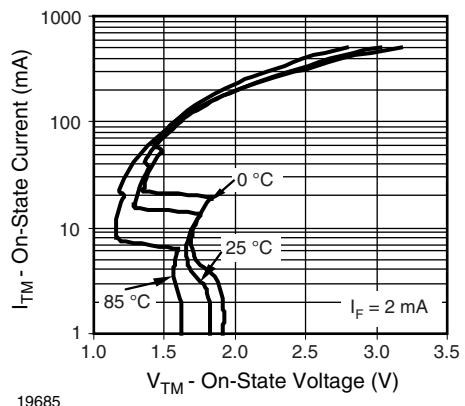
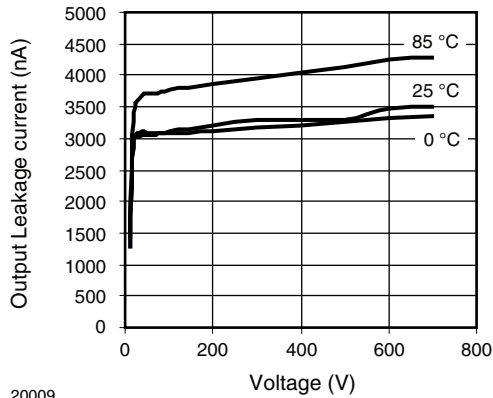
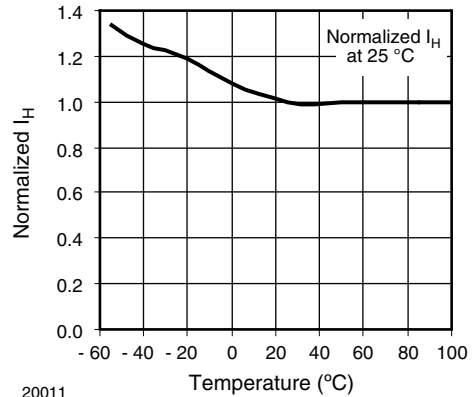

Fig. 5 - On-State Current vs. On-State Voltage



20009

Fig. 6 - Output Off Current (Leakage) vs. Voltage



20011

Fig. 9 - Normalized Holding Current vs. Temperature

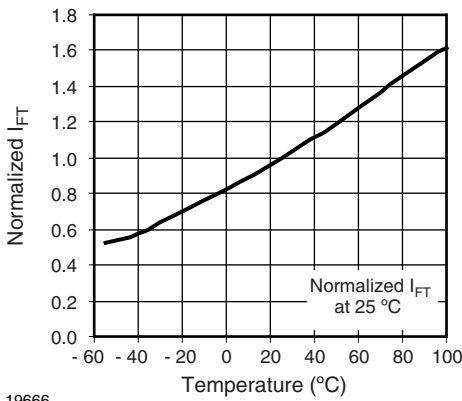

19666

Fig. 7 - Normalized Trigger Input Current vs. Temperature

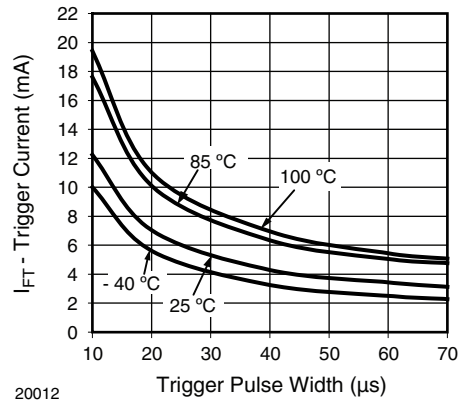

20012

Fig. 10 - I_{FT} vs. LED Pulse Width

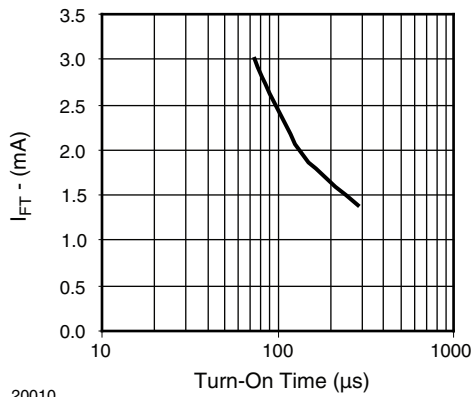

20010

Fig. 8 - I_{FT} (mA) vs. Turn-On Time (μ s)

PACKAGE DIMENSIONS in millimeters

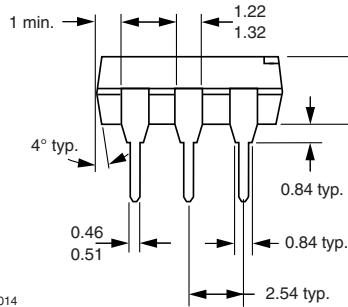
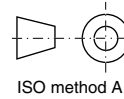
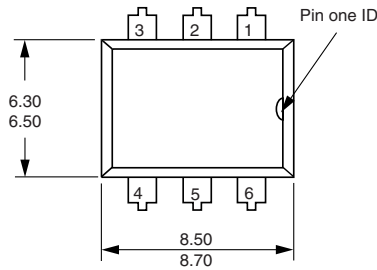

i178014

Option 6

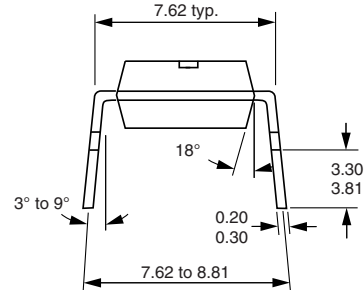

Option 7

Option 8

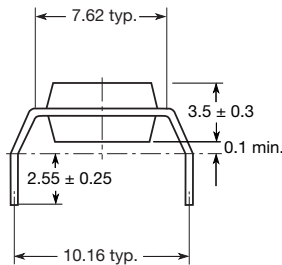

20802-41

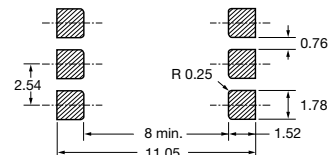
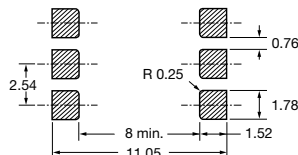
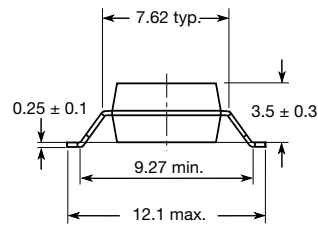
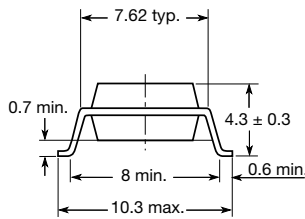

PACKAGE MARKING (example)

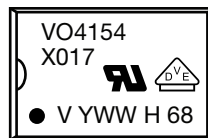

Notes

- Only options 1, 7, and 8 are reflected in the package marking.
- The VDE Logo is only marked on option 1 parts.
- Tape and reel suffix (T) is not part of the package marking.



Disclaimer

ALL PRODUCT, PRODUCT SPECIFICATIONS AND DATA ARE SUBJECT TO CHANGE WITHOUT NOTICE TO IMPROVE RELIABILITY, FUNCTION OR DESIGN OR OTHERWISE.

Vishay Intertechnology, Inc., its affiliates, agents, and employees, and all persons acting on its or their behalf (collectively, "Vishay"), disclaim any and all liability for any errors, inaccuracies or incompleteness contained in any datasheet or in any other disclosure relating to any product.

Vishay makes no warranty, representation or guarantee regarding the suitability of the products for any particular purpose or the continuing production of any product. To the maximum extent permitted by applicable law, Vishay disclaims (i) any and all liability arising out of the application or use of any product, (ii) any and all liability, including without limitation special, consequential or incidental damages, and (iii) any and all implied warranties, including warranties of fitness for particular purpose, non-infringement and merchantability.

Statements regarding the suitability of products for certain types of applications are based on Vishay's knowledge of typical requirements that are often placed on Vishay products in generic applications. Such statements are not binding statements about the suitability of products for a particular application. It is the customer's responsibility to validate that a particular product with the properties described in the product specification is suitable for use in a particular application. Parameters provided in datasheets and/or specifications may vary in different applications and performance may vary over time. All operating parameters, including typical parameters, must be validated for each customer application by the customer's technical experts. Product specifications do not expand or otherwise modify Vishay's terms and conditions of purchase, including but not limited to the warranty expressed therein.

Except as expressly indicated in writing, Vishay products are not designed for use in medical, life-saving, or life-sustaining applications or for any other application in which the failure of the Vishay product could result in personal injury or death. Customers using or selling Vishay products not expressly indicated for use in such applications do so at their own risk. Please contact authorized Vishay personnel to obtain written terms and conditions regarding products designed for such applications.

No license, express or implied, by estoppel or otherwise, to any intellectual property rights is granted by this document or by any conduct of Vishay. Product names and markings noted herein may be trademarks of their respective owners.

Material Category Policy

Vishay Intertechnology, Inc. hereby certifies that all its products that are identified as RoHS-Compliant fulfill the definitions and restrictions defined under Directive 2011/65/EU of The European Parliament and of the Council of June 8, 2011 on the restriction of the use of certain hazardous substances in electrical and electronic equipment (EEE) - recast, unless otherwise specified as non-compliant.

Please note that some Vishay documentation may still make reference to RoHS Directive 2002/95/EC. We confirm that all the products identified as being compliant to Directive 2002/95/EC conform to Directive 2011/65/EU.

Vishay Intertechnology, Inc. hereby certifies that all its products that are identified as Halogen-Free follow Halogen-Free requirements as per JEDEC JS709A standards. Please note that some Vishay documentation may still make reference to the IEC 61249-2-21 definition. We confirm that all the products identified as being compliant to IEC 61249-2-21 conform to JEDEC JS709A standards.



Стандарт Электрон Связь

Мы молодая и активно развивающаяся компания в области поставок электронных компонентов. Мы поставляем электронные компоненты отечественного и импортного производства напрямую от производителей и с крупнейших складов мира.

Благодаря сотрудничеству с мировыми поставщиками мы осуществляем комплексные и плановые поставки широчайшего спектра электронных компонентов.

Собственная эффективная логистика и склад в обеспечивает надежную поставку продукции в точно указанные сроки по всей России.

Мы осуществляем техническую поддержку нашим клиентам и предпродажную проверку качества продукции. На все поставляемые продукты мы предоставляем гарантию .

Осуществляем поставки продукции под контролем ВП МО РФ на предприятия военно-промышленного комплекса России , а также работаем в рамках 275 ФЗ с открытием отдельных счетов в уполномоченном банке. Система менеджмента качества компании соответствует требованиям ГОСТ ISO 9001.

Минимальные сроки поставки, гибкие цены, неограниченный ассортимент и индивидуальный подход к клиентам являются основой для выстраивания долгосрочного и эффективного сотрудничества с предприятиями радиоэлектронной промышленности, предприятиями ВПК и научно-исследовательскими институтами России.

С нами вы становитесь еще успешнее!

Наши контакты:

Телефон: +7 812 627 14 35

Электронная почта: sales@st-electron.ru

Адрес: 198099, Санкт-Петербург,
Промышленная ул, дом № 19, литера Н,
помещение 100-Н Офис 331