



Industry's first modular fuse block simplifies design and enhances safety

Bussmann
by **EAT•N**

Increase flexibility and electrical safety with Bussmann's snap-together Class H(K), J, and R knifeblade fuse blocks.

protection solutions to meet every application need, Eaton and Bussmann offer unmatched leadership in circuit protection.

As the only company with a complete portfolio of circuit

[More expertise. More solutions. Expect more.](#)



Leadership in Circuit Protection.

The only company that can provide a complete circuit protection solution for all applications.

Only Eaton can deliver...

- The most diverse solutions to mitigate arc flash energy to keep people and equipment safe
- The smallest and most cost effective way to meet selective coordination requirements
- The most experienced, time-tested solutions to meet national & local code requirements
- The easiest specifications with the most tested fuse/circuit breaker and circuit breaker/circuit breaker series rated combinations
- The only one-stop shop to solve your design challenges using our expertise and an unmatched portfolio

The Eaton advantage.

Powering business worldwide

As a global diversified power management company, we help customers worldwide manage the power needed for buildings, aircraft, trucks, cars, machinery and businesses.

Eaton's innovative technologies help customers manage electrical, hydraulic and mechanical power more reliably, efficiently, safely and sustainably.

We provide integrated solutions that help make energy, in all its forms, more practical and accessible.

With 2012 sales of \$16.3 billion, Eaton has approximately 103,000 employees around the world and sells products in more than 175 countries.

Eaton.com

EATON

Powering Business Worldwide

Bussmann knifeblade fuse blocks offer advantages you can't find anywhere else.



Modularity

The only snap-together design on the market permits assembly of required poles at point-of-use. Factory assembled two- and three-pole configurations are also available.



Best Ratings

All fuse blocks meet UL creep and clearance requirements for Industrial Control Circuits (UL 508, UL 845). 200 to 600A blocks meet the higher UL Industrial Power Distribution Standards (UL 98, UL 67, UL 489, UL 891, and UL 869A).



Ease-of-Use

Optional high-clarity, see-through finger-safe covers with test probe holes make routine maintenance activities easy. No need to open the cover to inspect wire terminations or to take thermography measurements. Available with any Class H(K), J or R fuse block.



Safety

For added safety and convenience, only Bussmann offers optional IP20 finger-safe covers across the entire knifeblade fuse block product line. Built-in lockout/ tagout feature improves safety. Blown fuse indication option on fuse cover assists in troubleshooting, while standard phase barriers between poles enhance safety.



QuikShip Services

In stock for QuikShip Everyday Service - 90% of orders ship within 24 hours. QuikShip Emergency Service ensures availability 24/7, 365 with "Next flight out" courier service.



Features and Benefits

- Integral dovetails allow assembly of multiple poles at point-of-use for greater application flexibility
- Factory assembled two- and three-pole configurations available
- Up to four mounting holes per pole increase installation flexibility
- Standard phase barriers between poles for additional safety
- Design meets UL creep and clearance requirements for Industrial Power Circuits (UL 508 and UL 845)
- 200 to 600A blocks meet the higher UL creep and clearance requirements for Power Distribution Standards (UL 98, UL 67, UL 489, UL 891 and UL 869A)
- Optional IP20 finger-safe covers available on entire knifeblade fuse block product line:
 - High-clarity see-through covers allow for inspecting wire terminations or thermography measurements without removing cover
 - Probe holes included for easy, safer testing and troubleshooting
 - Built-in lockout/tagout feature improves safety
- Standard fuse clip reinforcing springs enhance electrical contact



Specifications

Agency information:

Blocks - UL - Listed cULus E14853 - IZLT & IZLT7
 CSA - Certified 47235 - 6225-01
 Covers - UL - Listed UL E58836 - JDVS2

Ratings:

Volts - 250V, 600V
 Amps - 70-600A
 SCCR - 200kA (Class J & R)
 10kA (Class H & K)

Flammability ratings:

Blocks - UL 94V0, self-extinguishing
 Covers - UL 94HB, self-extinguishing

Operating and storage temperature range:

Blocks - -40°C to 120°C
 Covers - Non-indicating covers -40°C to 120°C
 - Indicating covers -20°C to 90°C

Materials:

Base - Thermoplastic
 Box Lug Terminals - Tin-plated aluminum

Wire:*

Cu/Al - 75°C/90°C (100 - 200A)
 Cu/Al - 75°C only (400 - 600A)**

*Higher temperature rated wire can be used with appropriate derating.
 **400A Class J double box lug rated for 75°C/90°C Cu/Al.



Features



Finger-safe wire entry with cutout tabs for larger wires on all versions



600A Version

(double box lug standard for easier wiring with smaller, dual conductors)

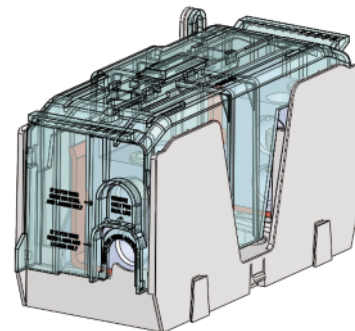

400A Class J Version

(JM60400-_MW22 with double box lug for easier wiring with smaller, dual conductors)

*No fuse derating necessary.

Knifeblade Fuse Block Part Number Table - 250 and 600V Class H(K) & R

Bussmann
by **Eaton**



250V Class H(K) and R



600V Class H(K) and R

Catalog Number		Covers*		Volts	Fuse Range (amps)	Number of Poles	Wire Range (solid and stranded)***	Wire Range (fine stranded Cu)	Torque N•m (Lb-In)	Bussmann Fuses
Class H(K)	Class R	w/o Indication	w/ Indication							
HM25100-1CR	RM25100-1CR	CVR-RH-25100	CVRI-RH-25100	250	70-100	1	–	1-3 AWG	6.2 (55)	Class H(K): NON
HM25100-2CR	RM25100-2CR					2	1/0-3 AWG; (2) Cu 4-6 AWG	4-6 AWG	5.6 (50)	
HM25100-3CR	RM25100-3CR					3	4-6 AWG; (2) Cu 8 AWG	8 AWG	5.1 (45)	
HM25200-1CR	RM25200-1CR	CVR-RH-25200	CVRI-RH-25200		110-200	1	250 MCM-1 AWG	3/0-1 AWG	42 (375)	Class R: LPN-RK_SP LPN-RK_SPI**
HM25200-2CR	RM25200-2CR					2	8 AWG; (2) Cu 10-14 AWG	–	4.5 (40)	
HM25200-3CR	RM25200-3CR					3	Cu 10-14 AWG; Al 10-12 AWG	–	4.0 (35)	
HM25400-1CR	RM25400-1CR	CVR-RH-25400	CVRI-RH-25400		225-400	1	600kcmil	N/A	57 (500)	FRN-R KTN-R
HM25400-2CR	RM25400-2CR					2	500kcmil-4 AWG		51 (450)	
HM25400-3CR	RM25400-3CR					3	(2) Cu 3/0 - 4 AWG (2) Al 3/0 - 4 AWG		57 (500) 34 (300)	
HM25600-1CR	RM25600-1CR	CVR-RH-25600	CVRI-RH-25600	450-600	1	(2) 500kcmil-4 AWG	N/A	51 (450)		
HM25600-2CR	RM25600-2CR				2					
HM25600-3CR	RM25600-3CR				3					
HM60100-1CR	RM60100-1CR	CVR-RH-60100	CVRI-RH-60100	600	70-100	1	–	1-3 AWG	6.2 (55)	Class H(K): NOS
HM60100-2CR	RM60100-2CR					2	1/0-3 AWG; (2) Cu 4-6 AWG	4-6 AWG	5.6 (50)	
HM60100-3CR	RM60100-3CR					3	4-6 AWG; (2) Cu 8 AWG	8 AWG	5.1 (45)	
HM60200-1CR	RM60200-1CR	CVR-RH-60200	CVRI-RH-60200		110-200	1	250 MCM-1 AWG	3/0-1 AWG	42 (375)	Class R: LPS-RK_SP LPS-RK_SPI**
HM60200-2CR	RM60200-2CR					2	8 AWG; (2) Cu 10-14 AWG	–	4.5 (40)	
HM60200-3CR	RM60200-3CR					3	Cu 10-14 AWG; Al 10-12 AWG	–	4.0 (35)	
HM60400-1CR	RM60400-1CR	CVR-RH-60400	CVRI-RH-60400		225-400	1	600kcmil	N/A	57 (500)	FRS-R KTS-R KWS-R PVS-R
HM60400-2CR	RM60400-2CR					2	500kcmil-4 AWG		51 (450)	
HM60400-3CR	RM60400-3CR					3	(2) Cu 3/0 - 4 AWG (2) Al 3/0 - 4 AWG		57 (500) 34 (300)	
HM60600-1CR	RM60600-1CR	CVR-RH-60600	CVRI-RH-60600	450-600	1	(2) 500kcmil-4 AWG	N/A	51 (450)		
HM60600-2CR	RM60600-2CR				2					
HM60600-3CR	RM60600-3CR				3					

*Covers sold separately. Blown fuse indication requires 90 volts minimum and closed circuit to operate.

**With *easyID*TM blown fuse indication.

***Ratings for copper and aluminum wire except where otherwise noted.



Class J

Catalog Number	Covers*		Volts	Fuse Range (amps)	Number of Poles	Wire Range (solid and stranded)***	Wire Range (fine stranded)	Torque N•m (Lb-In)	Bussmann Fuses
	w/o Indication	w/ Indication							
JM60100-1CR	CVR-J-60100	CVRI-J-60100	600	70-100	1	–	1-3 AWG	6.2 (55)	LPJ_SP LPJ_SPI** JKS DFJ
JM60100-2CR					2	1/0-3 AWG; (2) Cu 4-6 AWG	4-6 AWG	5.6 (50)	
JM60100-3CR					3	4-6 AWG; (2) Cu 8 AWG 8 AWG; (2) Cu 10-14 AWG Cu 10-14 AWG; Al 10-12 AWG	– –	4.5 (40) 4.0 (35)	
JM60200-1CR	CVR-J-60200	CVRI-J-60200		110-200	1	250 MCM-1 AWG	3/0-1 AWG	42 (375)	
JM60200-2CR					2	2-6 AWG; (2) Cu 2-6 AWG	2-6 AWG	31 (275)	
JM60200-3CR					3				
JM60400-1CR	CVR-J-60400-M	CVRI-J-60400-M		225-400	1	600kcmil	N/A	57 (500)	
JM60400-2CR					2	500kcmil-4 AWG		51 (450)	
JM60400-3CR					3	(2) Cu 3/0 - 4 AWG (2) Al 3/0 - 4 AWG		57 (500) 34 (300)	
JM60400-1MW22†					1	(2) 350kcmil-1 AWG (2) 2 AWG - 6 AWG		42 (375)	
JM60400-2MW22†			2		51 (275)				
JM60400-3MW22†			3						
JM60600-1CR			CVR-J-60600		CVRI-J-60600	450-600		1	(2) 500kcmil-4 AWG
JM60600-2CR	2								
JM60600-3CR	3								

*Covers sold separately. Blown fuse indication requires 90 volts minimum and closed circuit to operate.

**With *easyID*™ blown fuse indication.

***Ratings for copper and aluminum wire except where otherwise noted.

†400A Class J double box lug rated for 75°C/90°C Cu/Al.

Double Box Lug Configurations

- Allows for ease of installation with smaller, more flexible wire
- Capable of achieving maximum current rating with parallel copper or aluminum wires
- Standard on all 600A blocks
- Optional on 400A Class J blocks
- Compatible with IP20 finger-safe covers††

††For Class J 400A double box lug configuration, optional cover provides IP20 finger-safe protection for dual 350kcmil-1 AWG wires or one single 350kcmil-6 AWG wire.



Optional 400A
Class J Version
(JM60400- MW22)



All 600A Versions

Dimensions - mm (in)

70-100A

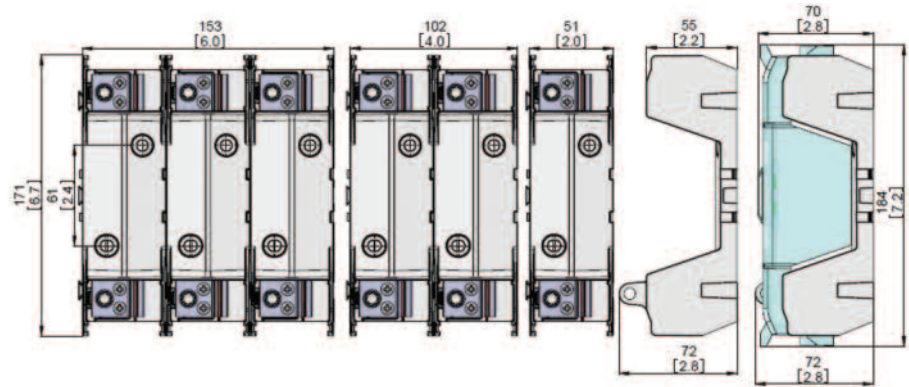

110-200A

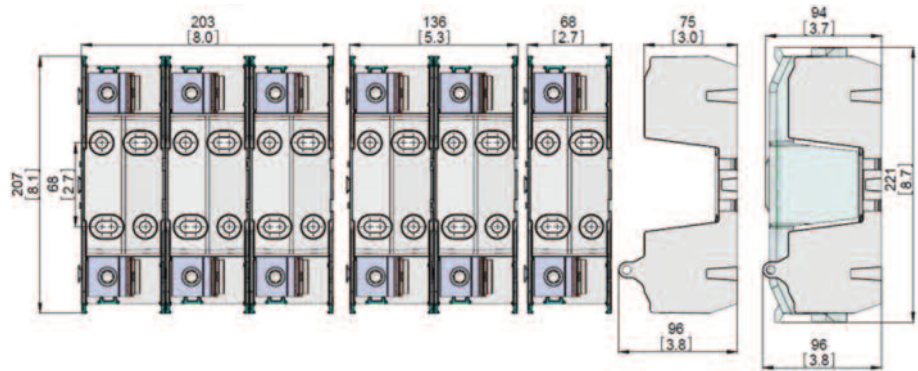

225-400A



450-600A



Dimensions - mm (in)

70-100A



110-200A



225-400A



450-600A



Dimensions - mm (in)

70-100A



110-200A









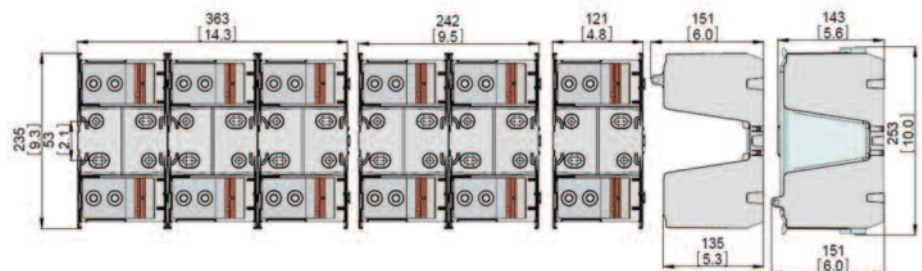
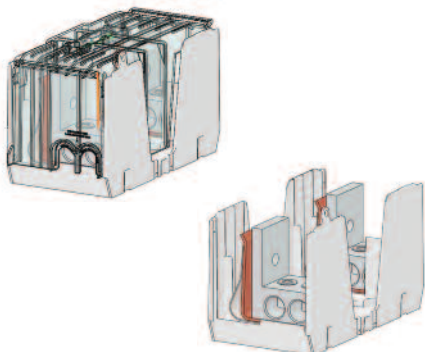

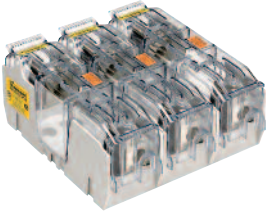

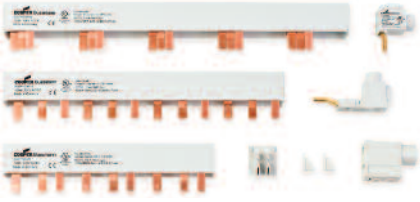
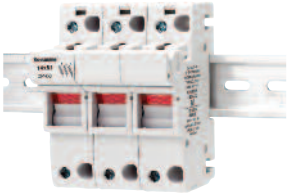

225-400A



450-600A



<p>Modular knifeblade fuse blocks with finger-safe covers</p>		<p>UL, IEC & PV CH modular fuse holder series</p>	
<p>UL Type 1 NEMA 4X SPDs</p>		<p>Comb-bus bar accessories for CH Series fuse holders</p>	
<p>IEC CH fuse holder series</p>		<p>CUBEFuse™ holder series</p>	
<p>Class J CH fuse holder series</p>		<p>Open design ferrule fuse block series</p>	
<p>Class J JTN 600 fuse holder series</p>		<p>Finger-safe, high SCCR power distribution blocks</p>	
<p>Optima™ midget & Class CC series</p>		<p>DIN-Rail terminal blocks</p>	
<p>Open design Class CC & midget series</p>		<p>Compact circuit protector fused disconnect switches</p>	

Customer Assistance

Customer Satisfaction Team

Available to answer questions regarding Bussmann products & services Monday-Friday, 7:00 a.m. – 6:00 p.m. Central Time. Contact:

- Toll-free phone: 855-287-7626 (855-BUSSMANN)
- Toll-free fax: 800-544-2570
- E-mail: busscustsat@cooperindustries.com

Emergency and After-Hours Orders

Next flight out or will call shipment for time-critical needs. Customers pay only standard product price, rush freight charges, & modest emergency service fee. Place these orders through the Customer Satisfaction Team during regular business hours. For after-hours, contact:

- After hours 314-995-1342

C3 – the Enhanced, Online Cooper Customer Center

Provides real time product availability, net pricing, order status & shipment tracking for: B-Line, Bussmann, Crouse-Hinds, Lighting, Power Systems & Wiring Devices. Call 877-995-5955 for log-in assistance. Available at:

- www.cooperc3.com

Application Engineering

Technical assistance is available to all customers. Application support is available Monday-Friday, 7:00 a.m. – 5:00 p.m. Central Time. Contact:

- Toll-free phone: 855-287-7626 (855-BUSSMANN)
- E-mail: fusetech@cooperindustries.com

Online Resources

Visit www.cooperbussmann.com for the following resources:

- Product search & cross-reference
- Product & technical materials
- Solutions centers for information on topical issues including arc flash, selective coordination & short-circuit current rating
- Technical tools, like our arc flash calculator
- Where to purchase Bussmann product

Eaton's Bussmann Business
PO Box 14460
St. Louis, MO 63178-44602
www.bussmann.com

Your authorized distributor is:



Eaton
1000 Eaton Boulevard
Cleveland, OH 44122
United States
Eaton.com

EATON
Powering Business Worldwide

© 2013 Eaton
All Rights Reserved
Printed in USA
Publication No. 3192
August 2013

Eaton is a registered trademark.

All other trademarks are property of their respective owners.



**Стандарт
Электрон
Связь**

Мы молодая и активно развивающаяся компания в области поставок электронных компонентов. Мы поставляем электронные компоненты отечественного и импортного производства напрямую от производителей и с крупнейших складов мира.

Благодаря сотрудничеству с мировыми поставщиками мы осуществляем комплексные и плановые поставки широчайшего спектра электронных компонентов.

Собственная эффективная логистика и склад в обеспечивает надежную поставку продукции в точно указанные сроки по всей России.

Мы осуществляем техническую поддержку нашим клиентам и предпродажную проверку качества продукции. На все поставляемые продукты мы предоставляем гарантию .

Осуществляем поставки продукции под контролем ВП МО РФ на предприятия военно-промышленного комплекса России , а также работаем в рамках 275 ФЗ с открытием отдельных счетов в уполномоченном банке. Система менеджмента качества компании соответствует требованиям ГОСТ ISO 9001.

Минимальные сроки поставки, гибкие цены, неограниченный ассортимент и индивидуальный подход к клиентам являются основой для выстраивания долгосрочного и эффективного сотрудничества с предприятиями радиоэлектронной промышленности, предприятиями ВПК и научно-исследовательскими институтами России.

С нами вы становитесь еще успешнее!

Наши контакты:

Телефон: +7 812 627 14 35

Электронная почта: sales@st-electron.ru

Адрес: 198099, Санкт-Петербург,
Промышленная ул, дом № 19, литера Н,
помещение 100-Н Офис 331