

NPN Silicon Germanium RF Transistor

- High gain ultra low noise RF transistor
- Provides outstanding performance for a wide range of wireless applications up to 10 GHz and more
- Ideal for CDMA and WLAN applications
- Outstanding noise figure $F = 0.5$ dB at 1.8 GHz
Outstanding noise figure $F = 0.85$ dB at 6 GHz
- High maximum stable gain
 $G_{ms} = 27$ dB at 1.8 GHz
- Gold metallization for extra high reliability
- 150 GHz f_T -Silicon Germanium technology
- Pb-free (RoHS compliant) package ¹⁾
- Qualified according AEC Q101

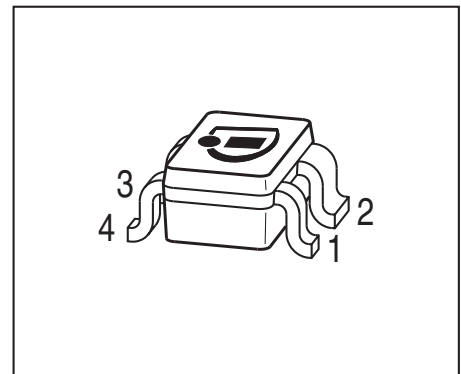

ESD (Electrostatic discharge) sensitive device, observe handling precaution!

Type	Marking	Pin Configuration						Package
BFP740	R7s	1=B	2=E	3=C	4=E	-	-	SOT343

¹⁾Pb-containing package may be available upon special request

Maximum Ratings

Parameter	Symbol	Value	Unit
Collector-emitter voltage $T_A > 0^\circ\text{C}$ $T_A \leq 0^\circ\text{C}$	V_{CEO}	4 3.5	V
Collector-emitter voltage	V_{CES}	13	
Collector-base voltage	V_{CBO}	13	
Emitter-base voltage	V_{EBO}	1.2	
Collector current	I_{C}	30	mA
Base current	I_{B}	3	
Total power dissipation ¹⁾ $T_{\text{S}} \leq 89^\circ\text{C}$	P_{tot}	160	mW
Junction temperature	T_{j}	150	$^\circ\text{C}$
Ambient temperature	T_{A}	-65 ... 150	
Storage temperature	T_{stg}	-65 ... 150	

Thermal Resistance

Parameter	Symbol	Value	Unit
Junction - soldering point ²⁾	R_{thJS}	≤ 380	K/W

Electrical Characteristics at $T_{\text{A}} = 25^\circ\text{C}$, unless otherwise specified

Parameter	Symbol	Values			Unit
		min.	typ.	max.	

DC Characteristics

Collector-emitter breakdown voltage $I_{\text{C}} = 1 \text{ mA}, I_{\text{B}} = 0$	$V_{(\text{BR})\text{CEO}}$	4	4.7	-	V
Collector-emitter cutoff current $V_{\text{CE}} = 13 \text{ V}, V_{\text{BE}} = 0$	I_{CES}	-	-	30	μA
Collector-base cutoff current $V_{\text{CB}} = 5 \text{ V}, I_{\text{E}} = 0$	I_{CBO}	-	-	100	nA
Emitter-base cutoff current $V_{\text{EB}} = 0.5 \text{ V}, I_{\text{C}} = 0$	I_{EBO}	-	-	3	μA
DC current gain $I_{\text{C}} = 25 \text{ mA}, V_{\text{CE}} = 3 \text{ V}, \text{pulse measured}$	h_{FE}	160	250	400	-

¹⁾ T_{S} is measured on the collector lead at the soldering point to the pcb

²⁾ For calculation of R_{thJA} please refer to Application Note Thermal Resistance

Electrical Characteristics at $T_A = 25^\circ\text{C}$, unless otherwise specified

Parameter	Symbol	Values			Unit
		min.	typ.	max.	
AC Characteristics (verified by random sampling)					
Transition frequency $I_C = 25\text{ mA}$, $V_{CE} = 3\text{ V}$, $f = 2\text{ GHz}$	f_T	-	42	-	GHz
Collector-base capacitance $V_{CB} = 3\text{ V}$, $f = 1\text{ MHz}$, $V_{BE} = 0$, emitter grounded	C_{cb}	-	0.08	0.14	pF
Collector emitter capacitance $V_{CE} = 3\text{ V}$, $f = 1\text{ MHz}$, $V_{BE} = 0$, base grounded	C_{ce}	-	0.24	-	
Emitter-base capacitance $V_{EB} = 0.5\text{ V}$, $f = 1\text{ MHz}$, $V_{CB} = 0$, collector grounded	C_{eb}	-	0.44	-	
Noise figure $I_C = 8\text{ mA}$, $V_{CE} = 3\text{ V}$, $f = 1.8\text{ GHz}$, $Z_S = Z_{Sopt}$ $I_C = 8\text{ mA}$, $V_{CE} = 3\text{ V}$, $f = 6\text{ GHz}$, $Z_S = Z_{Sopt}$	F	-	0.5 0.85	-	dB
Power gain, maximum stable ¹⁾ $I_C = 25\text{ mA}$, $V_{CE} = 3\text{ V}$, $Z_S = Z_{Sopt}$, $Z_L = Z_{Lopt}$, $f = 1.8\text{ GHz}$	G_{ms}	-	27	-	dB
Power gain, maximum available ¹⁾ $I_C = 25\text{ mA}$, $V_{CE} = 3\text{ V}$, $Z_S = Z_{Sopt}$, $Z_L = Z_{Lopt}$, $f = 6\text{ GHz}$	G_{ma}	-	17	-	dB
Transducer gain $I_C = 25\text{ mA}$, $V_{CE} = 3\text{ V}$, $Z_S = Z_L = 50\ \Omega$, $f = 1.8\text{ GHz}$ $f = 6\text{ GHz}$	$ S_{21e} ^2$	-	24.5 13.5	-	dB
Third order intercept point at output ²⁾ $V_{CE} = 3\text{ V}$, $I_C = 25\text{ mA}$, $Z_S = Z_L = 50\ \Omega$, $f = 1.8\text{ GHz}$	IP_3	-	25	-	dBm
1dB Compression point at output $I_C = 25\text{ mA}$, $V_{CE} = 3\text{ V}$, $Z_S = Z_L = 50\ \Omega$, $f = 1.8\text{ GHz}$	P_{-1dB}	-	11	-	

$$^1G_{ma} = |S_{21e} / S_{12e}| (k - (k^2 - 1)^{1/2}), G_{ms} = |S_{21e} / S_{12e}|$$

²IP3 value depends on termination of all intermodulation frequency components.
Termination used for this measurement is $50\ \Omega$ from 0.1 MHz to 6 GHz

Simulation Data

For SPICE-model as well as for S-parameters including noise parameters refer to our internet website: www.infineon.com/rf.models. Please consult our website and download the latest version before actually starting your design.

The simulation data have been generated and verified up to 12 GHz using typical devices. The BFP740 nonlinear SPICE-model reflects the typical DC- and RF-device performance with high accuracy.

Total power dissipation $P_{tot} = f(T_S)$

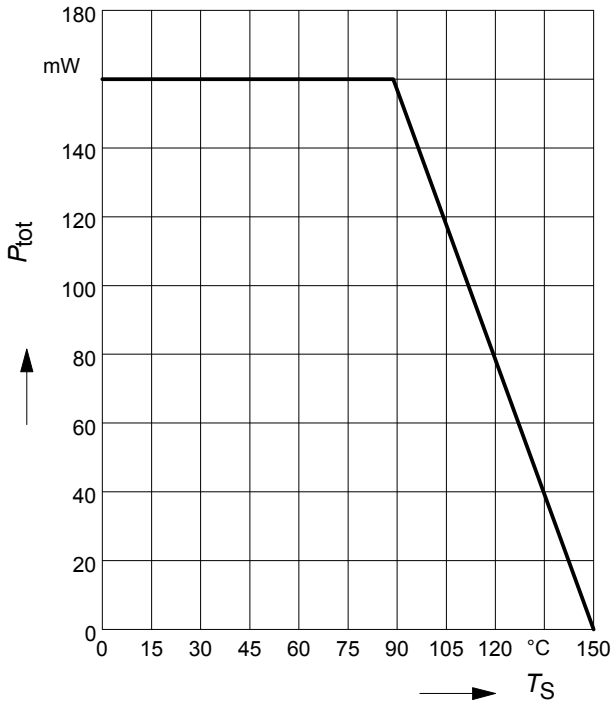

Permissible Pulse Load $R_{thJS} = f(t_p)$

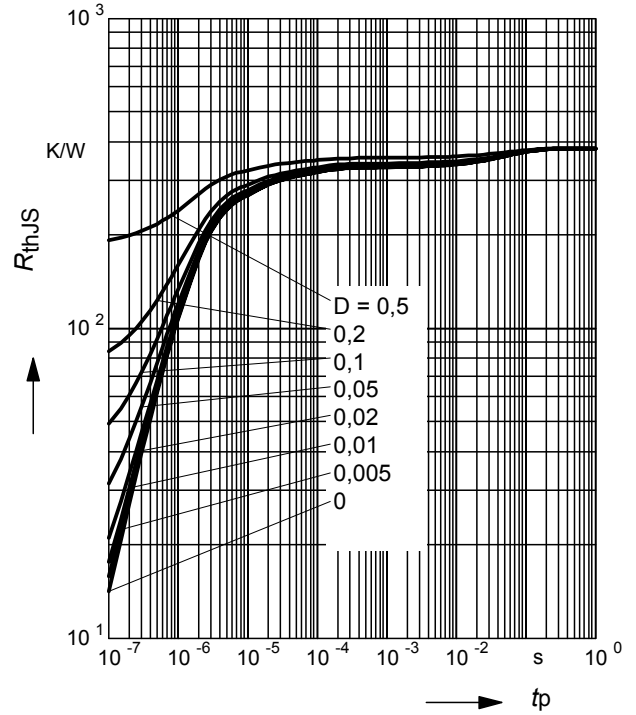

Permissible Pulse Load

$P_{totmax}/P_{totDC} = f(t_p)$

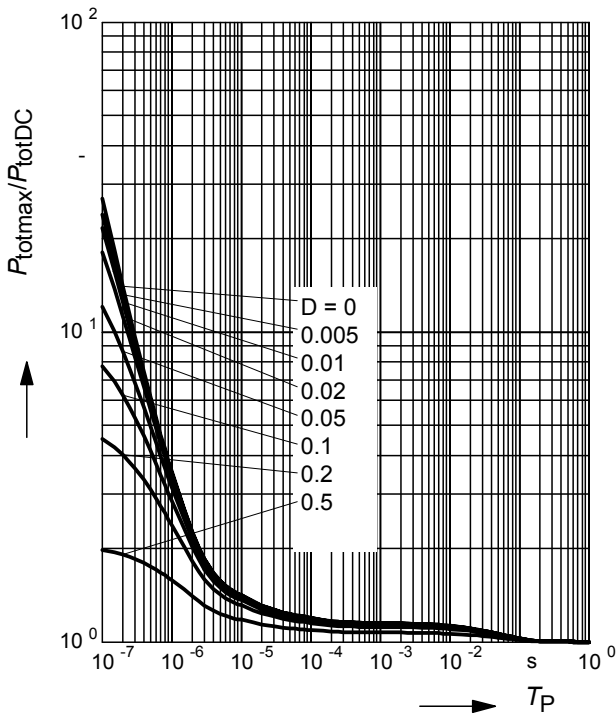

Collector-base capacitance $C_{cb} = f(V_{CB})$

$f = 1 \text{ MHz}$

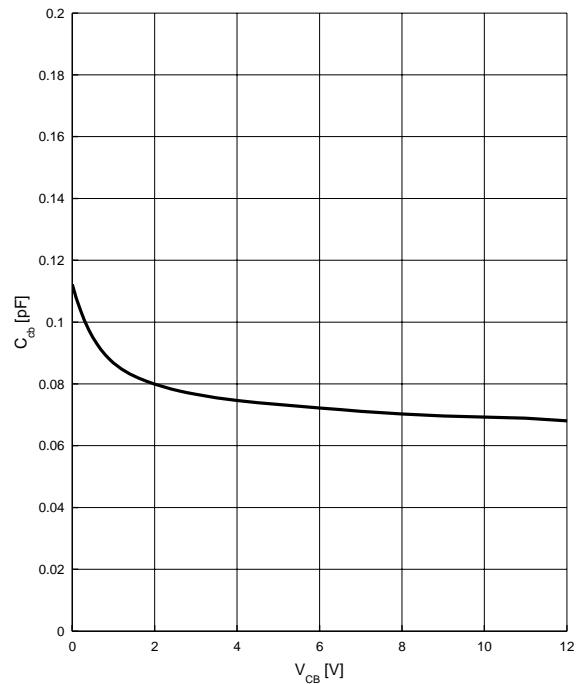

Third order Intercept Point $IP_3 = f(I_C)$

(Output, $Z_S = Z_L = 50 \Omega$)

V_{CE} = parameter, $f = 1.8 \text{ GHz}$

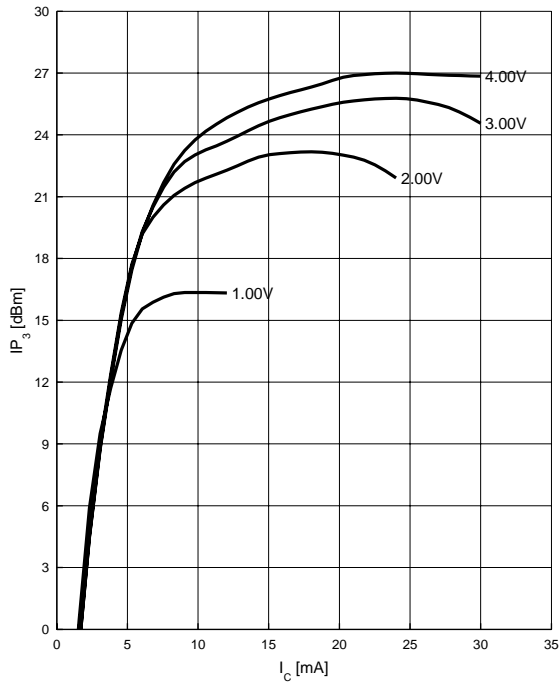

Transition frequency $f_T = f(I_C)$

$f = 2 \text{ GHz}$

V_{CE} = parameter

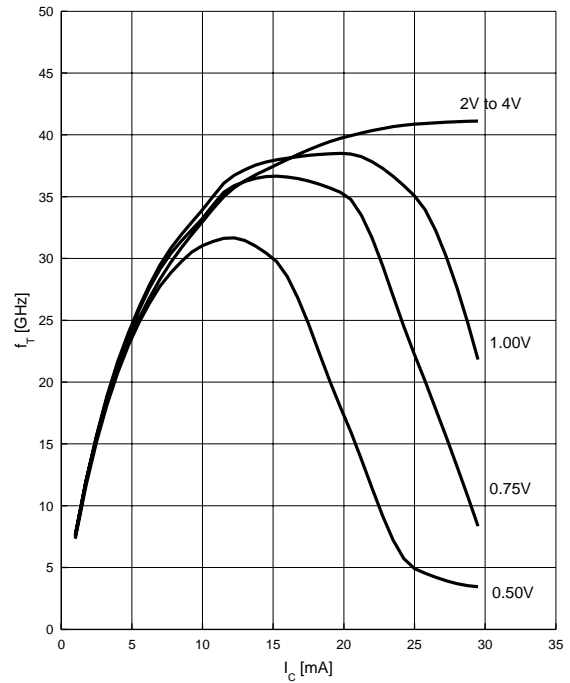

Power gain $G_{ma}, G_{ms} = f(f)$

$V_{CE} = 3 \text{ V}, I_C = 25 \text{ mA}$

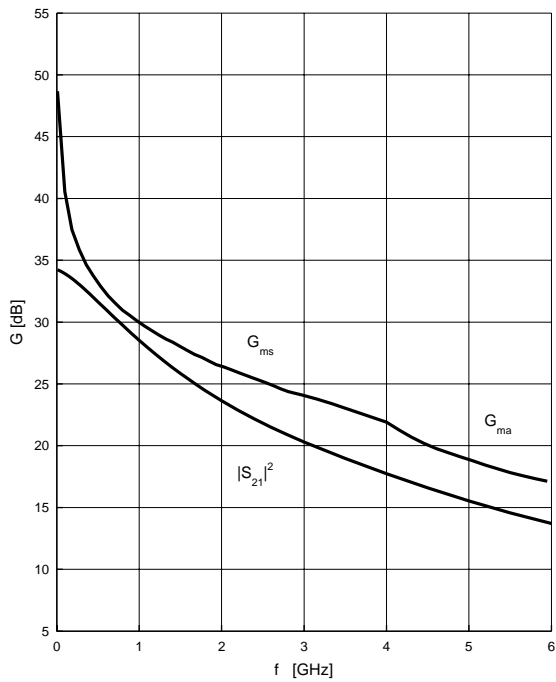

Power gain $G_{ma}, G_{ms} = f(I_C)$

$V_{CE} = 3 \text{ V}$

$f = \text{parameter}$

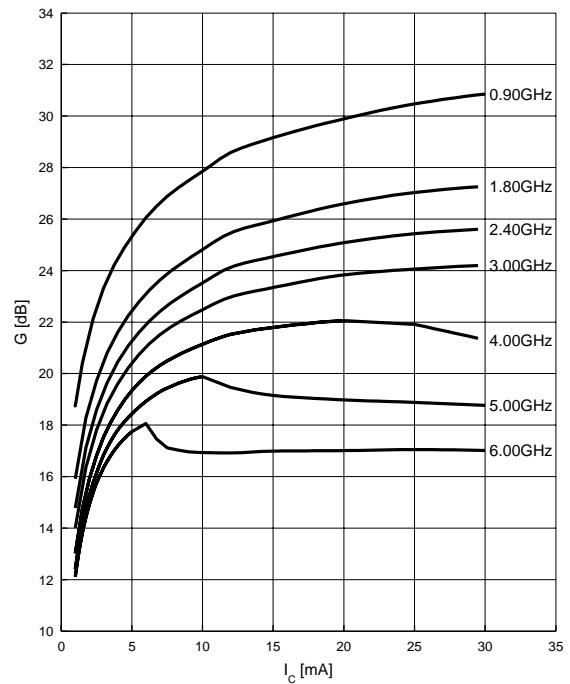

Power gain G_{ma} , $G_{ms} = f(V_{CE})$

$I_C = 25 \text{ mA}$

$f = \text{parameter}$

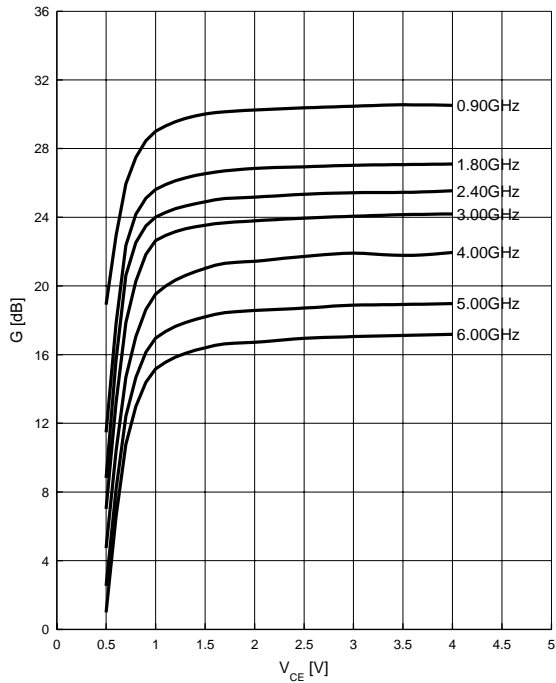

Noise figure $F = f(I_C)$

$V_{CE} = 3 \text{ V}$, $f = \text{parameter}$

$Z_S = Z_{Sopt}$

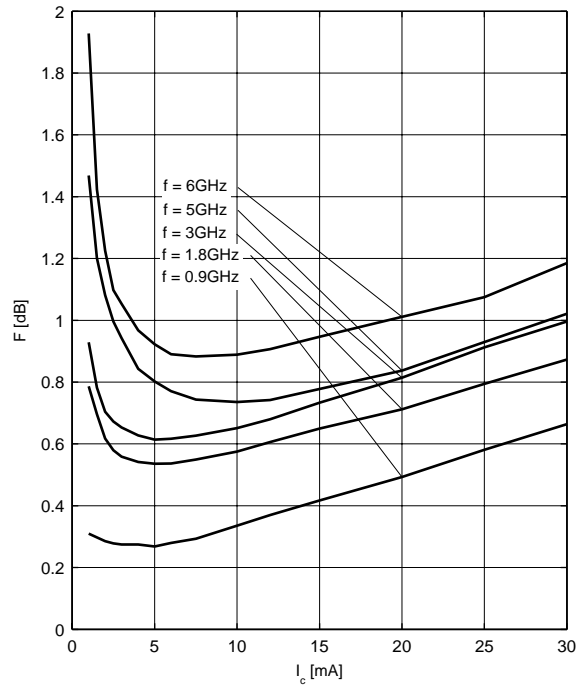

Noise figure $F = f(I_C)$

$V_{CE} = 3 \text{ V}$, $f = 1.8 \text{ GHz}$

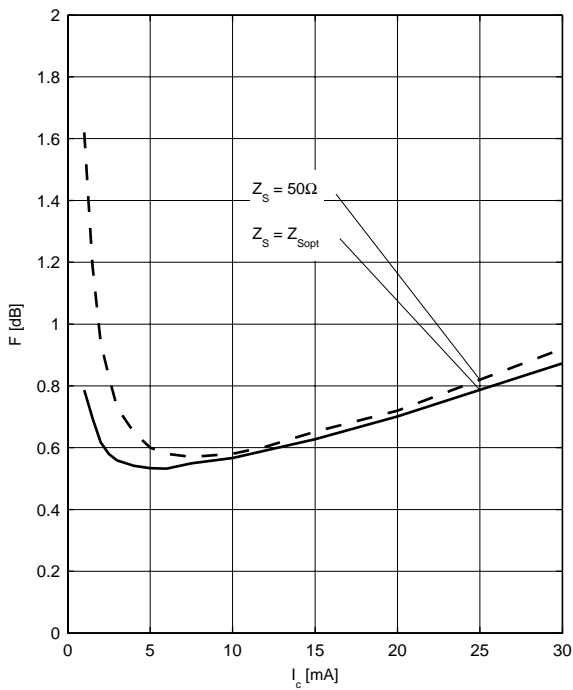

Noise figure $F = f(f)$

$V_{CE} = 3 \text{ V}$, $Z_S = Z_{Sopt}$

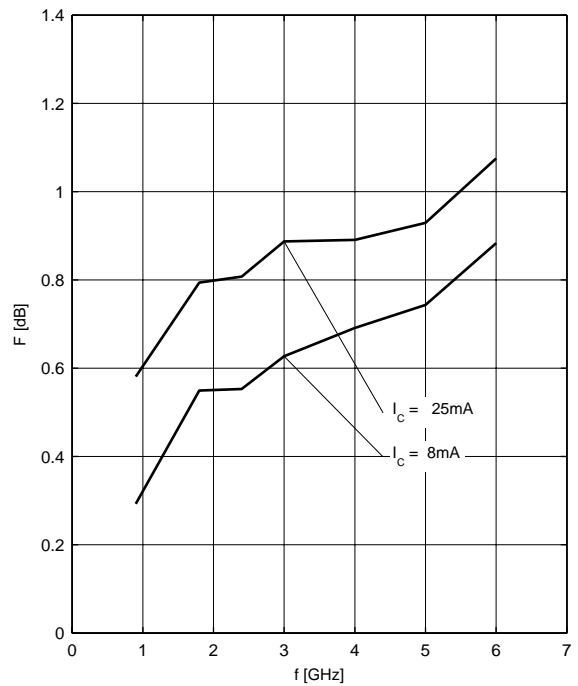

Source impedance for min.

noise figure vs. frequency

$V_{CE} = 3\text{ V}$, $I_C = 8\text{ mA} / 25\text{ mA}$

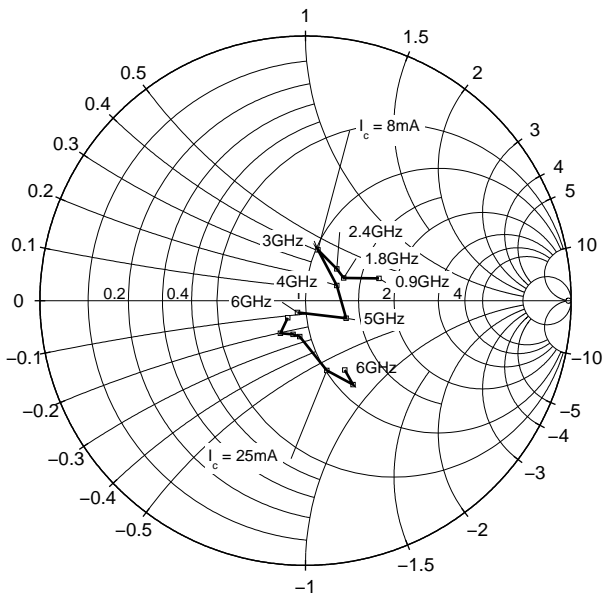

Package Outline

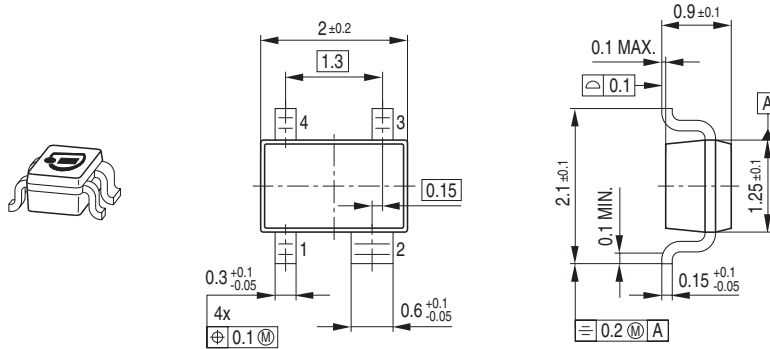

Foot Print

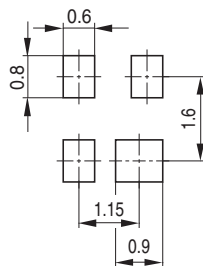

Marking Layout (Example)

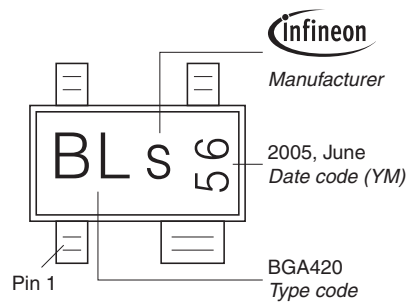

Standard Packing

Reel ø180 mm = 3.000 Pieces/Reel
 Reel ø330 mm = 10.000 Pieces/Reel

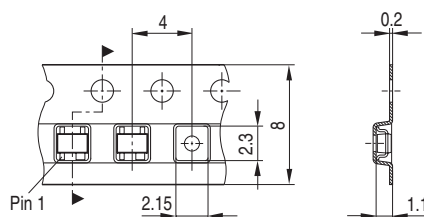

Edition 2009-11-16

**Published by
Infineon Technologies AG
81726 Munich, Germany**

**© 2009 Infineon Technologies AG
All Rights Reserved.**

Legal Disclaimer

The information given in this document shall in no event be regarded as a guarantee of conditions or characteristics. With respect to any examples or hints given herein, any typical values stated herein and/or any information regarding the application of the device, Infineon Technologies hereby disclaims any and all warranties and liabilities of any kind, including without limitation, warranties of non-infringement of intellectual property rights of any third party.

Information

For further information on technology, delivery terms and conditions and prices, please contact the nearest Infineon Technologies Office (www.infineon.com).

Warnings

Due to technical requirements, components may contain dangerous substances. For information on the types in question, please contact the nearest Infineon Technologies Office.

Infineon Technologies components may be used in life-support devices or systems only with the express written approval of Infineon Technologies, if a failure of such components can reasonably be expected to cause the failure of that life-support device or system or to affect the safety or effectiveness of that device or system. Life support devices or systems are intended to be implanted in the human body or to support and/or maintain and sustain and/or protect human life. If they fail, it is reasonable to assume that the health of the user or other persons may be endangered.



Стандарт Электрон Связь

Мы молодая и активно развивающаяся компания в области поставок электронных компонентов. Мы поставляем электронные компоненты отечественного и импортного производства напрямую от производителей и с крупнейших складов мира.

Благодаря сотрудничеству с мировыми поставщиками мы осуществляем комплексные и плановые поставки широчайшего спектра электронных компонентов.

Собственная эффективная логистика и склад в обеспечивает надежную поставку продукции в точно указанные сроки по всей России.

Мы осуществляем техническую поддержку нашим клиентам и предпродажную проверку качества продукции. На все поставляемые продукты мы предоставляем гарантию .

Осуществляем поставки продукции под контролем ВП МО РФ на предприятия военно-промышленного комплекса России , а также работаем в рамках 275 ФЗ с открытием отдельных счетов в уполномоченном банке. Система менеджмента качества компании соответствует требованиям ГОСТ ISO 9001.

Минимальные сроки поставки, гибкие цены, неограниченный ассортимент и индивидуальный подход к клиентам являются основой для выстраивания долгосрочного и эффективного сотрудничества с предприятиями радиоэлектронной промышленности, предприятиями ВПК и научно-исследовательскими институтами России.

С нами вы становитесь еще успешнее!

Наши контакты:

Телефон: +7 812 627 14 35

Электронная почта: sales@st-electron.ru

Адрес: 198099, Санкт-Петербург,
Промышленная ул, дом № 19, литера Н,
помещение 100-Н Офис 331